

FLORENTINA-4X1-O

~45° + 15° oval beam

TECHNICAL SPECIFICATIONS:

Dimensions	169.7 x 49.7 mm
Height	28.5 mm
Fastening	pin
ROHS compliant	yes 

MATERIAL SPECIFICATIONS:

Component	Type	Material	Colour	Finish
ROSE-CMC-O	Single lens	PC	clear	
FLORENTINA-4X1-HLD	Holder	PC	black	







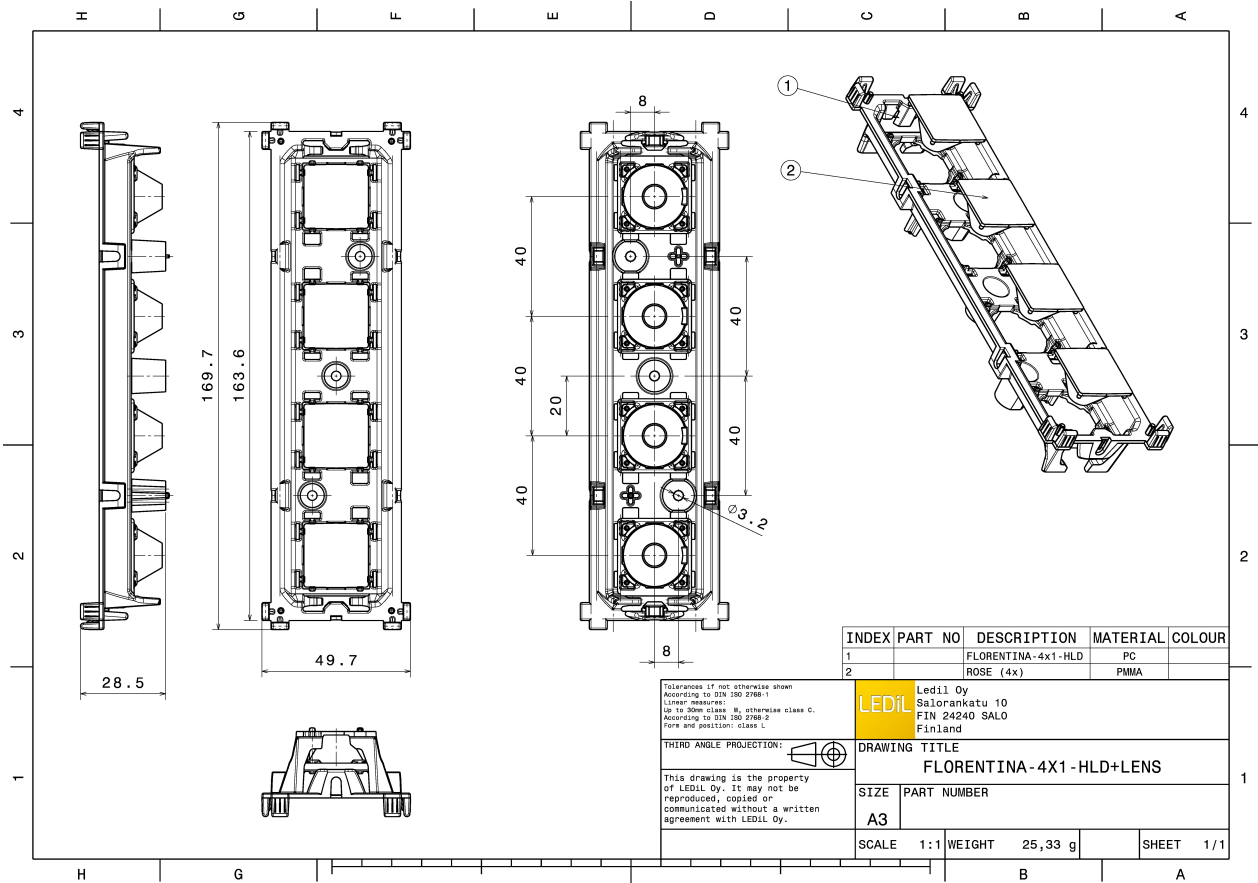

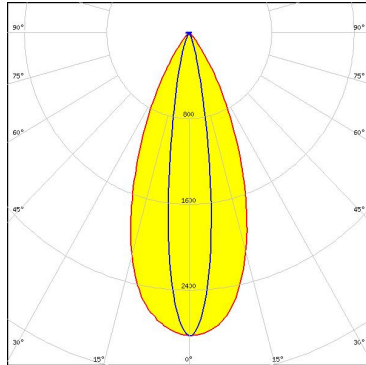

ORDERING INFORMATION:

Component		Qty in box	MOQ	MPQ	Box weight (kg)
FCP15347_FLORENTINA-4X1-O	Single lens	72	72	8	3.4
» Box size: 476 x 273 x 292 mm					

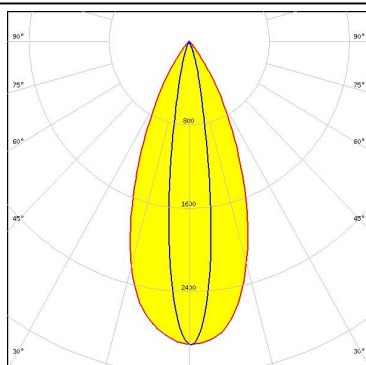

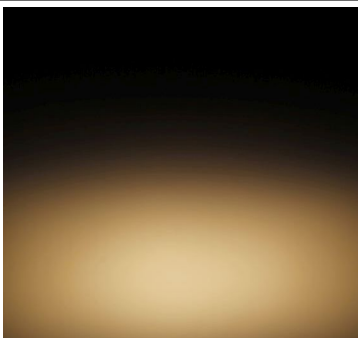
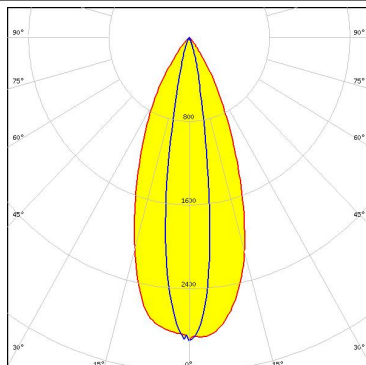
PHOTOMETRIC DATA (MEASURED):

<p></p> <p>LED EASY-T FLUX 1x4 FLR XG xxx G7 FWHM 43.0 + 16.0° Efficiency 75 % Peak intensity 2.8 cd/lm LEDs/each optic 1 Light colour White Required components: C15028_FLORENTINA-4X1-SHD</p>		
<p></p> <p>LED EASY-T FLUX 1x4 FLR XT xxx G5 FWHM 44.0 + 16.0° Efficiency 72 % Peak intensity 2.9 cd/lm LEDs/each optic 1 Light colour White Required components: C15028_FLORENTINA-4X1-SHD</p>		
<p></p> <p>LED XP-G2 FWHM 41.0 + 17.0° Efficiency 71 % Peak intensity 2.9 cd/lm LEDs/each optic 1 Light colour White Required components: C15028_FLORENTINA-4X1-SHD</p>		
<p></p> <p>LED XP-G2 FWHM 41.0 + 17.0° Efficiency 71 % Peak intensity 2.9 cd/lm LEDs/each optic 1 Light colour White Required components: C15198_FLORENTINA-4X1-SHD-OPEN</p>		

PHOTOMETRIC DATA (MEASURED):



LED XP-L2
 FWHM 43.0 + 19.0°
 Efficiency 76 %
 Peak intensity 2.3 cd/lm
 LEDs/each optic 1
 Light colour White
 Required components:
 C15690_FLORENTINA-4X1-SHD-WHT

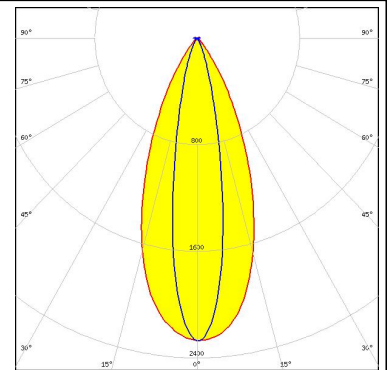

LED XP-L2
 FWHM 42.0 + 19.0°
 Efficiency 72 %
 Peak intensity 2.3 cd/lm
 LEDs/each optic 1
 Light colour White
 Required components:
 C15198_FLORENTINA-4X1-SHD-OPEN

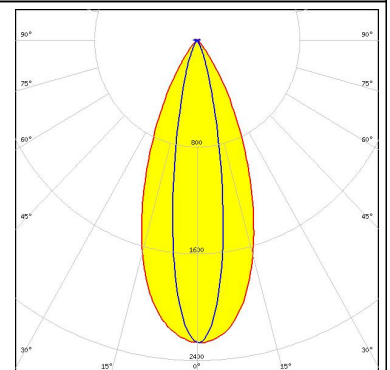
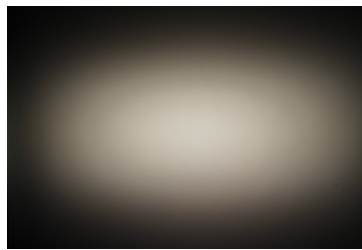

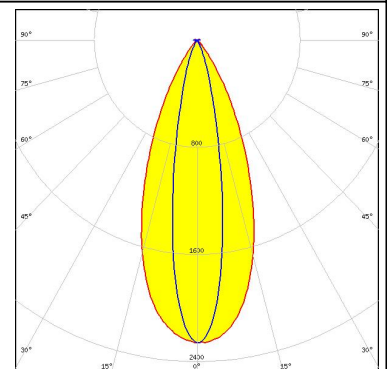
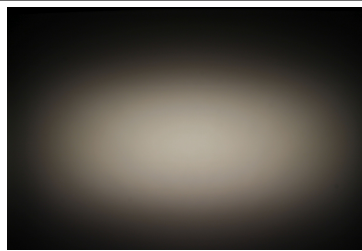

LED XP-L2
 FWHM 43.0 + 19.0°
 Efficiency 72 %
 Peak intensity 2.3 cd/lm
 LEDs/each optic 1
 Light colour White
 Required components:
 C15028_FLORENTINA-4X1-SHD

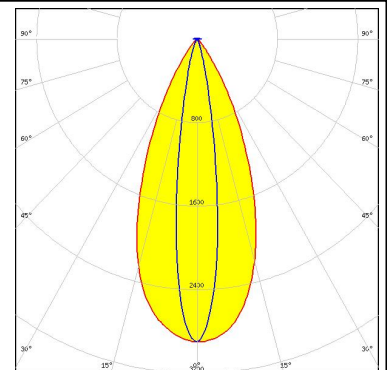

LED NVSxx19B/NVSxx19C
 FWHM 44.0 + 16.0°
 Efficiency 78 %
 Peak intensity 2.9 cd/lm
 LEDs/each optic 1
 Light colour White
 Required components:
 C15690_FLORENTINA-4X1-SHD-WHT

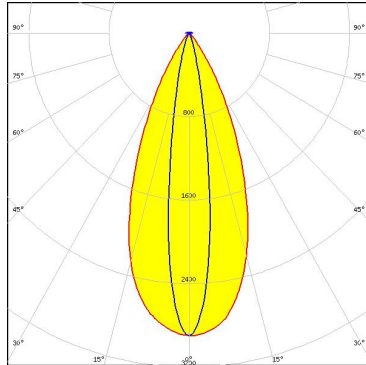
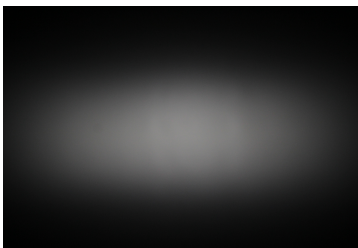
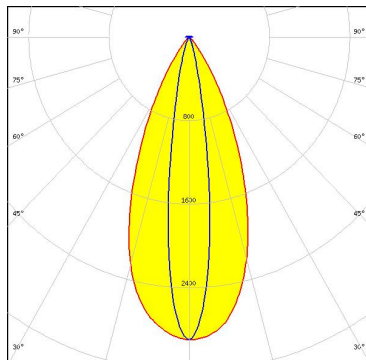

PHOTOMETRIC DATA (MEASURED):

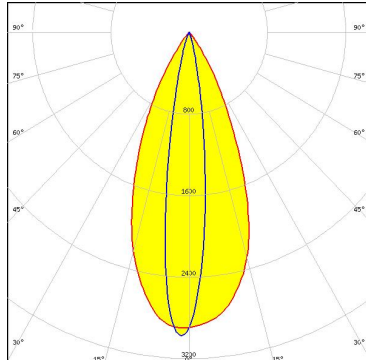
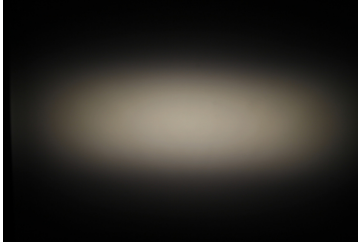
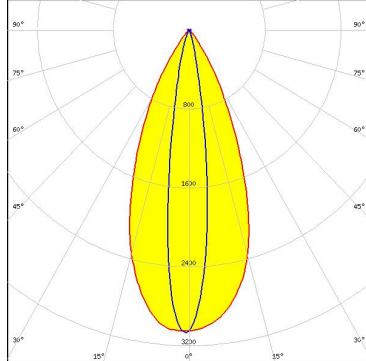
<p>NICHIA</p> <p>LED NVSxx19B/NVSxx19C FWHM 44.0 + 16.0° Efficiency 75 % Peak intensity 2.9 cd/lm LEDs/each optic 1 Light colour White Required components: C15198_FLORENTINA-4X1-SHD-OPEN</p>		
<p>NICHIA</p> <p>LED NVSxx19B/NVSxx19C FWHM 44.0 + 16.0° Efficiency 79 % Peak intensity 2.9 cd/lm LEDs/each optic 1 Light colour White Required components: C15028_FLORENTINA-4X1-SHD</p>		
<p>OSRAM <small>Opto Semiconductors</small></p> <p>LED OSLON Square CSSRM2/CSSRM3 FWHM 44.0 + 15.0° Efficiency 69 % Peak intensity 3 cd/lm LEDs/each optic 1 Light colour White Required components: C15198_FLORENTINA-4X1-SHD-OPEN</p>		
<p>OSRAM <small>Opto Semiconductors</small></p> <p>LED OSLON Square CSSRM2/CSSRM3 FWHM 44.0 + 15.0° Efficiency 74 % Peak intensity 3 cd/lm LEDs/each optic 1 Light colour White Required components: C15028_FLORENTINA-4X1-SHD</p>		

PHOTOMETRIC DATA (SIMULATED):



LED XP-L HD
FWHM 10.0 + 25.0°
Efficiency 198 %
Peak intensity 2.5 cd/lm
LEDs/each optic 1
Light colour White
Required components:
C15028_FLORENTINA-4X1-SHD

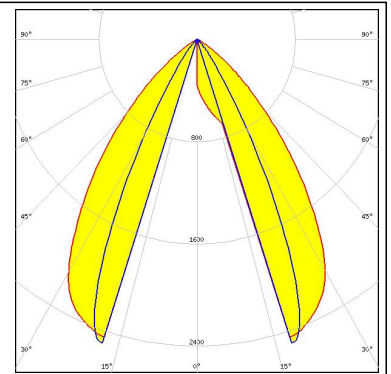

GENERAL INFORMATION:

NOTE: The typical beam angle will be changed by different color, chip size and chip position tolerance. The typical total beam angle is the full angle measured where the luminous intensity is half of the peak value.

MATERIALS:

As part of our continuous research and improvement processes, and to ensure the best possible quality and availability of our products, LEDiL reserves the right to change material grades without notice.

PRODUCT DATA USER AGREEMENT AND DISCLAIMER:

The measured data in the provided downloadable LEDiL Product Datasheets and Mechanical 2D-Drawings is rounded and provided as reference for planning. LEDiL Oy's optical specifications have been verified by conducting performance testing of the products in accordance with the company's quality system. The reported data are averaged results of multiple measurements with typical variation. LEDiL Oy reserves the right to without prior notification make changes and improvements to its products.

LEDiL Oy assumes neither warranty, nor guarantee nor any other liability of any kind for the contents and correctness of the provided data. The provided data has been generated with highest diligence but the provided data may in reality not represent the complete possible variation range of all intrinsic parameters. Therefore, in certain cases a deviation from the provided data could occur.

LEDiL Oy reserves the right to undertake technical changes of its products without further notification which could lead to changes in the provided data. LEDiL Oy assumes no liability of any kind for the possible deviation from any provided data or any other damage resulting from the usage of the provided data.

The user agrees to this disclaimer and user agreement with the download or usage of the provided files.

LEDiL Oy

Joensuunkatu 13
FI-24240 SALO
Finland

LEDiL Inc.

228 West Page Street
Suite D
Sycamore IL 60178
USA

Local sales and technical support

[www.ledil.com/
where_to_buy](http://www.ledil.com/where_to_buy)

Shipping locations

Salo, Finland
Hong Kong, China

Distribution Partners

[www.ledil.com/
where_to_buy](http://www.ledil.com/where_to_buy)

Компания «Океан Электроники» предлагает заключение долгосрочных отношений при поставках импортных электронных компонентов на взаимовыгодных условиях!

Наши преимущества:

- Поставка оригинальных импортных электронных компонентов напрямую с производств Америки, Европы и Азии, а так же с крупнейших складов мира;
- Широкая линейка поставок активных и пассивных импортных электронных компонентов (более 30 млн. наименований);
- Поставка сложных, дефицитных, либо снятых с производства позиций;
- Оперативные сроки поставки под заказ (от 5 рабочих дней);
- Экспресс доставка в любую точку России;
- Помощь Конструкторского Отдела и консультации квалифицированных инженеров;
- Техническая поддержка проекта, помощь в подборе аналогов, поставка прототипов;
- Поставка электронных компонентов под контролем ВП;
- Система менеджмента качества сертифицирована по Международному стандарту ISO 9001;
- При необходимости вся продукция военного и аэрокосмического назначения проходит испытания и сертификацию в лаборатории (по согласованию с заказчиком);
- Поставка специализированных компонентов военного и аэрокосмического уровня качества (Xilinx, Altera, Analog Devices, Intersil, Interpoint, Microsemi, Actel, Aeroflex, Peregrine, VPT, Syfer, Eurofarad, Texas Instruments, MS Kennedy, Miteq, Cobham, E2V, MA-COM, Hittite, Mini-Circuits, General Dynamics и др.);

Компания «Океан Электроники» является официальным дистрибьютором и эксклюзивным представителем в России одного из крупнейших производителей разъемов военного и аэрокосмического назначения «**JONHON**», а так же официальным дистрибьютором и эксклюзивным представителем в России производителя высокотехнологичных и надежных решений для передачи СВЧ сигналов «**FORSTAR**».



JONHON

«**JONHON**» (основан в 1970 г.)

Разъемы специального, военного и аэрокосмического назначения:

(Применяются в военной, авиационной, аэрокосмической, морской, железнодорожной, горно- и нефтедобывающей отраслях промышленности)

«**FORSTAR**» (основан в 1998 г.)

ВЧ соединители, коаксиальные кабели,
кабельные сборки и микроволновые компоненты:

(Применяются в телекоммуникациях гражданского и специального назначения, в средствах связи, РЛС, а так же военной, авиационной и аэрокосмической отраслях промышленности).



Телефон: 8 (812) 309-75-97 (многоканальный)

Факс: 8 (812) 320-03-32

Электронная почта: ocean@oceanchips.ru

Web: <http://oceanchips.ru/>

Адрес: 198099, г. Санкт-Петербург, ул. Калинина, д. 2, корп. 4, лит. А