

# R2A20111SP

R03DS0092EJ0401

Rev.4.01

Jan 08, 2016

## Power Factor Correction Controller IC

### Description

The R2A20111 is a power-factor correction (PFC) controller IC.

This IC adopts continuous conduction mode as PFC operation.

Various functions such as constant power limit, overvoltage detection, overcurrent detection, soft start, feedback-loop disconnection detection, and holding function of PFC operation through momentary outage (PFC hold function) are incorporated in a single chip. These functions reduce external circuitry.

The constant power limit function allows to eliminate a significant amount of coil noise which is generated due to overcurrent detection operation in case of conventional overload.

The PFC hold function enables quick recovery by continuing PFC operation after momentary outage. The hold time can be adjusted by an external capacitance.

Overcurrent detection pin is separately provided.

Latch mode shutdown function is incorporated.

A soft-start control pin provides for the easy adjustment of soft-start operation, and can be used to prevent overshooting of the output voltage.

### Features

- Maximum ratings
  - Power-supply voltage  $V_{cc}$ : 24 V
  - Junction temperature  $T_j$ : -40 to 125°C
- Electrical characteristics
  - VREF output voltage VREF: 5.0 V  $\pm$  3%
  - UVLO operation start voltage  $V_H$ : 10.5  $\pm$  0.9 V
  - UVLO operation stop voltage  $V_L$ : 9.0  $\pm$  0.7 V
  - PFC output maximum ON duty  $D_{max-out}$ : 95% (typ.)
- Functions
  - Constant power limit function
  - Continuous conduction mode
  - Hold function of PFC operation on momentary outage (PFC hold function)
  - Overvoltage detection
  - Overcurrent detection
  - Soft start
  - Feedback loop disconnection detection
  - IC shutdown function
  - Package lineup: SOP-16

### Applications

- Flat panel display
- Projector
- Desktop PC
- White goods

### Ordering Information

Part No.	Package Name	Package Code	Taping Spec.
R2A20111SPW0	FP-16DAV	PRSP0016DH-B	2000 pcs./one taping product



## Pin Arrangement

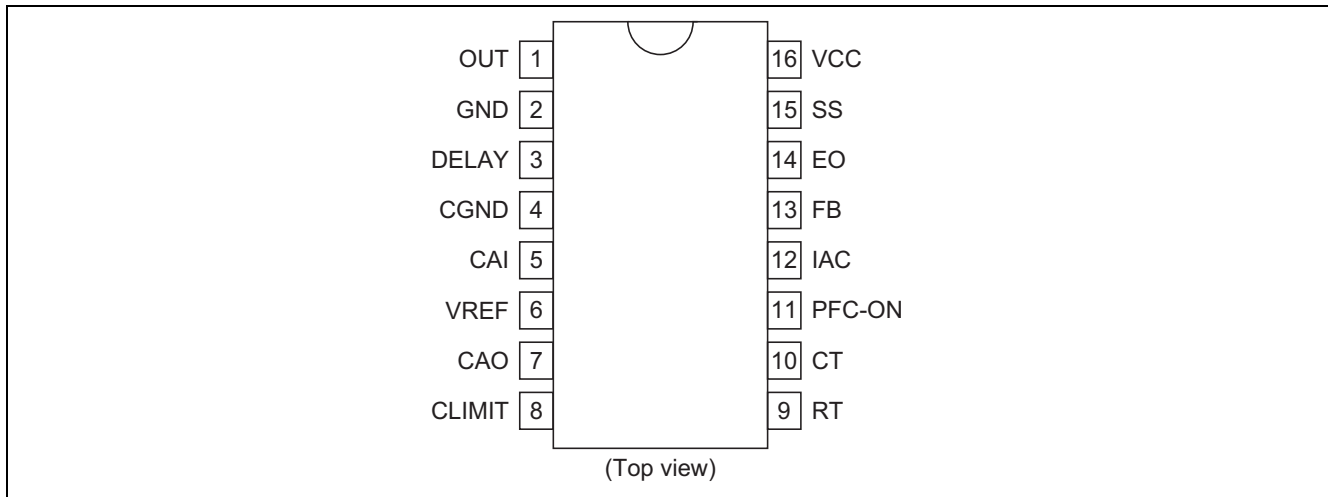

## Pin Description

Pin No.	Pin Name	I/O	Function
1	OUT	Output	Power MOS FET gate driver output
2	GND	—	Ground
3	DELAY	Input/Output	Hold time adjust and IC shutdown
4	CGND	Input	Non-inverting input of current amplifier
5	CAI	Input/Output	Inverting input of current amplifier and Current output for PFC control
6	VREF	Output	Reference voltage output
7	CAO	Output	Current amplifier output
8	CLIMIT	Input	Overcurrent detection
9	RT	Input/Output	Timing resistor for settings of operational frequency, and the maximum CAI pin and DELAY pin current
10	CT	Output	Timing capacitor for operational frequency adjust
11	PFC-ON	Input	Detection of input AC voltage level
12	IAC	Input	Detection of input AC waveform
13	FB	Input	Voltage amplifier input
14	EO	Output	Voltage amplifier output
15	SS	Output	Timing capacitor for soft-start time adjust
16	VCC	Input	Power supply voltage input

## Absolute Maximum Ratings

(Ta = 25°C)

Item	Symbol	Ratings	Unit	Note
Supply voltage	VCC	24	V	
OUT peak current	Ipk-out	±1.0	A	3
OUT DC current	Idc-out	±0.1	A	
Terminal voltage	Vi-group1	-0.3 to Vcc	V	4
	Vi-group2	-0.3 to Vref	V	5
CAO voltage	Vcao	-0.3 to Vcaoh	V	
EO voltage	Veo	-0.3 to Veoh	V	
DELAY voltage	Vdelay	-0.3 to +6.5	V	
CAI voltage	Vi-cs	-1.5 to +0.3	V	
RT current	Irt	-200	μA	
IAC current	Iiac	0.6	mA	
VREF current	Io-ref	-5	mA	
Power dissipation	Pt	1	W	6
Operating ambient temperature	Ta-opr	-40 to +105	°C	
Junction temperature	Tj	-40 to +125	°C	7
Storage temperature	Tstg	-55 to +150	°C	

- Notes: 1. Rated voltages are with reference to the GND pin.  
 2. For rated currents, inflow to the IC is indicated by (+), and outflow by (-).  
 3. The transient current when driving capacitive load.  
 4. This is the rated voltage for the following pin:  
 OUT.  
 5. This is the rated voltage for the following pins:  
 CGND, VREF, CLIMIT, RT, CT, PFC-ON, IAC, FB, SS  
 6. Thermal resistance of packages

Package	θja	θjc	Note
SOP16	120°C/W	—	40 × 40 × 1.6 [mm], Mounted on a glass epoxy printed board with 10% wiring density
	—	35°C/W	Infinite heat sink

7. Stresses exceeding the absolute maximum ratings may damage the device.  
 These are stress ratings only. Functional operation above the recommended operating ambient temperature range is not implied.  
 Extended exposure to stresses above the absolute maximum ratings may affect device reliability.

## Electrical Characteristics

(Ta = 25°C, VCC = 12 V, RT = 27 kΩ, CT = 1000 pF)

	Item	Symbol	Min	Typ	Max	Unit	Test Conditions
Supply	Start threshold	VH	9.6	10.5	11.4	V	
	Shutdown threshold	VL	8.3	9.0	9.7	V	
	UVLO hysteresis	dVUVL	1.0	1.5	2.0	V	
	Startup current	Is	140	200	260	μA	VCC = 9.5 V
	Is temperature stability	dIs/dTa	—	-0.3	—	%/°C	*1
	Operating current	Icc	3.45	4.5	6.45	mA	IAC = 0 A, CL = 0 F
VREF	Output voltage	Vref	4.85	5.00	5.15	V	Isource = 1 mA
	Line regulation	Vref-line	—	5	20	mV	Isource = 1 mA, VCC = 12 V to 23 V
	Load regulation	Vref-load	—	5	20	mV	Isource = 1 mA to 5 mA
	Temperature stability	dVref	—	±80	—	ppm/°C	Ta = -40 to 125°C *1
Oscillator	Initial accuracy	fout	58.5	65	71.5	kHz	Measured pin: OUT
	fout temperature stability	dfout/dTa	—	±0.1	—	%/°C	Ta = -40 to 125°C *1
	fout voltage stability	fout-line	-1.5	0.5	1.5	%	VCC = 12 V to 18 V
	CT peak voltage	Vct-H	—	3.6	4.0	V	*1
	Ramp valley voltage	Vct-L	—	0.65	—	V	*1
	RT voltage	Vrt	1.17	1.25	1.33	V	
Soft start	Sink current	Iss	15.0	25.0	35.0	μA	SS = 2 V
Current limit	Threshold voltage	VCL	1.222	1.3	1.378	V	
	Delay to output	td-CL	—	100	200	ns	CLIMIT = 2 to 0 V
VAMP	Feedback voltage	Vfb	2.40	2.50	2.60	V	FB-EO Short
	Input bias current	Ifb	-0.3	0	0.3	μA	Measured pin: FB
	Open loop gain	Av-v	—	53	—	dB	*1
	High voltage	Veoh	5.2	5.7	6.2	V	FB = 2.3 V, EO: Open
	Low voltage	Veol	—	0.1	0.3	V	FB = 2.7 V, EO: Open
	Source current	Isrc-eo	-180	-120	-90	μA	FB = 1.0 V, EO = 2.5 V
	Sink current	Isrc-eo	90	120	180	μA	FB = 4.0 V, EO = 2.5 V
	Transconductance	Gm-v	150	200	290	μA/V	FB = 2.5 V, EO = 2.5 V
CAMP	Input offset voltage	Vio-ca	—	(-10)	0	mV	*1
	Open loop gain	Av-ca	—	68	—	dB	*1
	High voltage	Vcaoh	5.2	5.7	6.2	V	
	Low voltage	Vcaol	—	0.1	0.3	V	
	Source current	Isrc-ca	-135	-90	-67	μA	CAO = 2.5 V
	Sink current	Isrc-ca	67	90	135	μA	CAO = 2.5 V
	Transconductance	Gm-c	530	700	1000	μA/V	*1

Note: 1. Design spec.

## Electrical Characteristics (cont.)

(Ta = 25°C, VCC = 12 V, RT = 27 kΩ, CT = 1000 pF)

Item		Symbol	Min	Typ	Max	Unit	Test Conditions
IAC/ Multiplier	IAC pin voltage	Viac	1.6	2.3	3.0	V	IAC = 100 μA
	Imo current 1	Imo1	-61.3	-51.5	-41	μA	EO = 2.5 V, IAC = 150 μA PFC-ON = 1.2 V
	Imo current 2	Imo2	-197.9	-165	-131.5	μA	EO = Vcaoh, IAC = 150 μA PFC-ON = 1.2 V
	Imo current 3	Imo3	-32.8	-27	-21.2	μA	EO = 2.5 V, IAC = 375 μA PFC-ON = 2.5 V
	Imo current 4	Imo4	-110.4	-92	-73.6	μA	EO = Vcaoh, IAC = 375 μA PFC-ON = 2.5 V
OUT	Minimum duty cycle	Dmin-out	—	—	0	%	CAO = 4.0 V
	Maximum duty cycle	Dmax-out	90	95	98	%	CAO = 0 V
	Rise time	tr-out	—	30	100	ns	CL = 1000 pF
	Fall time	tf-out	—	30	100	ns	CL = 1000 pF
	Low voltage	Vol1-out	—	0.05	0.2	V	Iout = 20 mA
		Vol2-out	—	0.5	2.0	V	Iout = 200 mA (Pulse test)
		Vol3-out	—	0.03	0.7	V	Iout = 10 mA, VCC = 5 V
High voltage	Voh1-out	11.5	11.9	—	V	Iout = -20 mA	
	Voh2-out	10.0	11.0	—	V	Iout = -200 mA (Pulse test)	
Shut down	Shut down voltage	Vshut	3.30	4.00	4.70	V	Input: DELAY
	Reset voltage	Vres	—	—	4.0	V	Input: Vcc
	Shut down current	Ishut	120	190	260	μA	VCC = 9 V
Supervisor	PFC enable voltage	Von-pfc	0.74	0.82	0.9	V	Input pin: PFC-ON
	PFC disable voltage	Voff-pfc	0.71	0.79	0.86	V	Input pin: PFC-ON
	PFC disable delay threshold voltage	Vd-pfc	1.05	1.20	1.30	V	Input pin: DELAY
	Input current	Ipfc-on	-1.0	-0.2	1	μA	PFC-ON = 2 V
	B+ OVP set voltage	dVovps	0.125	0.188	0.250	V	Input pin: FB *2
	B+ OVP reset voltage	dVovpr	0.075	0.138	0.200	V	Input pin: FB *2
	FB low set voltage	Vfbls	0.425	0.52	0.615	V	Input pin: FB
	DELAY source current	Isrc-delay	-47.5	-42.5	-38	μA	DELAY = 1 V RT = 27 kΩ
	DELAY sink current	Isrc-delay	—	770	—	μA	DELAY = 1 V RT = 27 kΩ *1

Notes: 1. Design spec.

2.  $dVovps = Vovps - Vref \times 0.5$   
 $dVovpr = Vovpr - Vref \times 0.5$

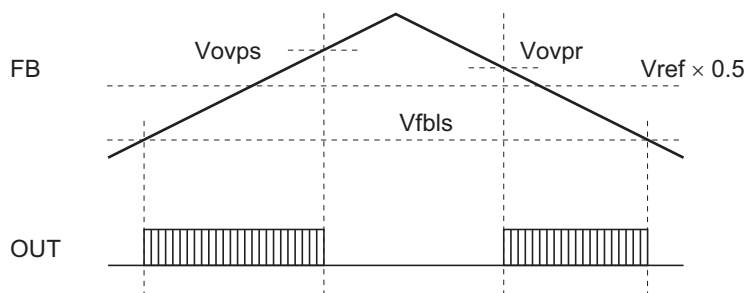

### Package Dimensions

JEITA Package Code	RENESAS Code	Previous Code	MASS[Typ.]
P-SOP16-5.5x10.06-1.27	PRSP0016DH-B	FP-16DAV	0.24g

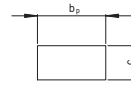
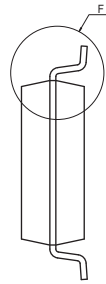
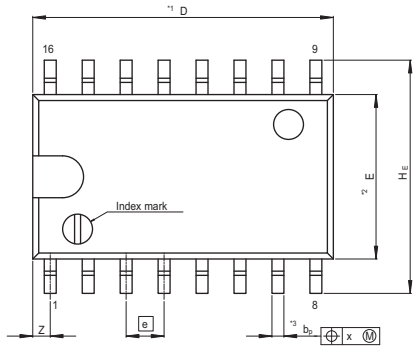

Terminal cross section  
( Ni/Pd/Au plating )

NOTE)  
1. DIMENSIONS\*\*1 (Nom)\*AND\*\*2\*  
DO NOT INCLUDE MOLD FLASH.  
2. DIMENSION\*\*3\*DOES NOT  
INCLUDE TRIM OFFSET.

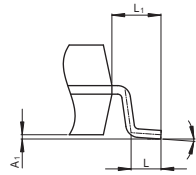
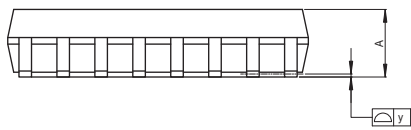

Detail F

Reference Symbol	Dimension in Millimeters		
	Min	Nom	Max
D	—	10.06	10.5
E	—	5.50	—
A <sub>2</sub>	—	—	—
A <sub>1</sub>	0.00	0.10	0.20
A	—	—	2.20
b <sub>p</sub>	0.34	0.40	0.46
b <sub>1</sub>	—	—	—
c	0.15	0.20	0.25
c <sub>1</sub>	—	—	—
θ	0°	—	8°
HE	7.50	7.80	8.00
⓪	—	1.27	—
x	—	—	0.12
y	—	—	0.15
Z	—	—	0.80
L	0.50	0.70	0.90
L <sub>1</sub>	—	1.15	—

## Notice

1. Descriptions of circuits, software and other related information in this document are provided only to illustrate the operation of semiconductor products and application examples. You are fully responsible for the incorporation of these circuits, software, and information in the design of your equipment. Renesas Electronics assumes no responsibility for any losses incurred by you or third parties arising from the use of these circuits, software, or information.
2. Renesas Electronics has used reasonable care in preparing the information included in this document, but Renesas Electronics does not warrant that such information is error free. Renesas Electronics assumes no liability whatsoever for any damages incurred by you resulting from errors in or omissions from the information included herein.
3. Renesas Electronics does not assume any liability for infringement of patents, copyrights, or other intellectual property rights of third parties by or arising from the use of Renesas Electronics products or technical information described in this document. No license, express, implied or otherwise, is granted hereby under any patents, copyrights or other intellectual property rights of Renesas Electronics or others.
4. You should not alter, modify, copy, or otherwise misappropriate any Renesas Electronics product, whether in whole or in part. Renesas Electronics assumes no responsibility for any losses incurred by you or third parties arising from such alteration, modification, copy or otherwise misappropriation of Renesas Electronics product.
5. Renesas Electronics products are classified according to the following two quality grades: "Standard" and "High Quality". The recommended applications for each Renesas Electronics product depends on the product's quality grade, as indicated below.  
"Standard": Computers; office equipment; communications equipment; test and measurement equipment; audio and visual equipment; home electronic appliances; machine tools; personal electronic equipment; and industrial robots etc.  
"High Quality": Transportation equipment (automobiles, trains, ships, etc.); traffic control systems; anti-disaster systems; anti-crime systems; and safety equipment etc.  
Renesas Electronics products are neither intended nor authorized for use in products or systems that may pose a direct threat to human life or bodily injury (artificial life support devices or systems, surgical implantations etc.), or may cause serious property damages (nuclear reactor control systems, military equipment etc.). You must check the quality grade of each Renesas Electronics product before using it in a particular application. You may not use any Renesas Electronics product for any application for which it is not intended. Renesas Electronics shall not be in any way liable for any damages or losses incurred by you or third parties arising from the use of any Renesas Electronics product for which the product is not intended by Renesas Electronics.
6. You should use the Renesas Electronics products described in this document within the range specified by Renesas Electronics, especially with respect to the maximum rating, operating supply voltage range, movement power voltage range, heat radiation characteristics, installation and other product characteristics. Renesas Electronics shall have no liability for malfunctions or damages arising out of the use of Renesas Electronics products beyond such specified ranges.
7. Although Renesas Electronics endeavors to improve the quality and reliability of its products, semiconductor products have specific characteristics such as the occurrence of failure at a certain rate and malfunctions under certain use conditions. Further, Renesas Electronics products are not subject to radiation resistance design. Please be sure to implement safety measures to guard them against the possibility of physical injury, and injury or damage caused by fire in the event of the failure of a Renesas Electronics product, such as safety design for hardware and software including but not limited to redundancy, fire control and malfunction prevention, appropriate treatment for aging degradation or any other appropriate measures. Because the evaluation of microcomputer software alone is very difficult, please evaluate the safety of the final products or systems manufactured by you.
8. Please contact a Renesas Electronics sales office for details as to environmental matters such as the environmental compatibility of each Renesas Electronics product. Please use Renesas Electronics products in compliance with all applicable laws and regulations that regulate the inclusion or use of controlled substances, including without limitation, the EU RoHS Directive. Renesas Electronics assumes no liability for damages or losses occurring as a result of your noncompliance with applicable laws and regulations.
9. Renesas Electronics products and technology may not be used for or incorporated into any products or systems whose manufacture, use, or sale is prohibited under any applicable domestic or foreign laws or regulations. You should not use Renesas Electronics products or technology described in this document for any purpose relating to military applications or use by the military, including but not limited to the development of weapons of mass destruction. When exporting the Renesas Electronics products or technology described in this document, you should comply with the applicable export control laws and regulations and follow the procedures required by such laws and regulations.
10. It is the responsibility of the buyer or distributor of Renesas Electronics products, who distributes, disposes of, or otherwise places the product with a third party, to notify such third party in advance of the contents and conditions set forth in this document, Renesas Electronics assumes no responsibility for any losses incurred by you or third parties as a result of unauthorized use of Renesas Electronics products.
11. This document may not be reproduced or duplicated in any form, in whole or in part, without prior written consent of Renesas Electronics.
12. Please contact a Renesas Electronics sales office if you have any questions regarding the information contained in this document or Renesas Electronics products, or if you have any other inquiries.

(Note 1) "Renesas Electronics" as used in this document means Renesas Electronics Corporation and also includes its majority-owned subsidiaries.

(Note 2) "Renesas Electronics product(s)" means any product developed or manufactured by or for Renesas Electronics.



### SALES OFFICES

Renesas Electronics Corporation

<http://www.renesas.com>

Refer to "<http://www.renesas.com/>" for the latest and detailed information.

#### Renesas Electronics America Inc.

2801 Scott Boulevard Santa Clara, CA 95050-2549, U.S.A.  
Tel: +1-408-588-6000, Fax: +1-408-588-6130

#### Renesas Electronics Canada Limited

9251 Yonge Street, Suite 8309 Richmond Hill, Ontario Canada L4C 9T3  
Tel: +1-905-237-2004

#### Renesas Electronics Europe Limited

Dukes Meadow, Millboard Road, Bourne End, Buckinghamshire, SL8 5FH, U.K.  
Tel: +44-1628-585-100, Fax: +44-1628-585-900

#### Renesas Electronics Europe GmbH

Arcadiastrasse 10, 40472 Düsseldorf, Germany  
Tel: +49-211-6503-0, Fax: +49-211-6503-1327

#### Renesas Electronics (China) Co., Ltd.

Room 1709, Quantum Plaza, No.27 ZhiChunLu Haidian District, Beijing 100191, P.R.China  
Tel: +86-10-8235-1155, Fax: +86-10-8235-7679

#### Renesas Electronics (Shanghai) Co., Ltd.

Unit 301, Tower A, Central Towers, 555 Langao Road, Putuo District, Shanghai, P. R. China 200333  
Tel: +86-21-2226-0888, Fax: +86-21-2226-0999

#### Renesas Electronics Hong Kong Limited

Unit 1601-1611, 16/F., Tower 2, Grand Century Place, 193 Prince Edward Road West, Mongkok, Kowloon, Hong Kong  
Tel: +852-2265-6688, Fax: +852 2886-9022

#### Renesas Electronics Taiwan Co., Ltd.

13F, No. 363, Fu Shing North Road, Taipei 10543, Taiwan  
Tel: +886-2-8175-9600, Fax: +886 2-8175-9670

#### Renesas Electronics Singapore Pte. Ltd.

80 Bendemeer Road, Unit #06-02 Hyflux Innovation Centre, Singapore 339949  
Tel: +65-6213-0200, Fax: +65-6213-0300

#### Renesas Electronics Malaysia Sdn.Bhd.

Unit 1207, Block B, Menara Amcorp, Amcorp Trade Centre, No. 18, Jln Persiaran Barat, 46050 Petaling Jaya, Selangor Darul Ehsan, Malaysia  
Tel: +60-3-7955-9390, Fax: +60-3-7955-9510

#### Renesas Electronics India Pvt. Ltd.

No.77C, 100 Feet Road, HAL II Stage, Indiranagar, Bangalore, India  
Tel: +91-80-67208700, Fax: +91-80-67208777

#### Renesas Electronics Korea Co., Ltd.

12F., 234 Teheran-ro, Gangnam-Gu, Seoul, 135-080, Korea  
Tel: +82-2-558-3737, Fax: +82-2-558-5141



# Mouser Electronics

Authorized Distributor

Click to View Pricing, Inventory, Delivery & Lifecycle Information:

[Renesas Electronics:](#)

[R2A20111SP#W0](#)

Компания «Океан Электроники» предлагает заключение долгосрочных отношений при поставках импортных электронных компонентов на взаимовыгодных условиях!

Наши преимущества:

- Поставка оригинальных импортных электронных компонентов напрямую с производств Америки, Европы и Азии, а так же с крупнейших складов мира;
- Широкая линейка поставок активных и пассивных импортных электронных компонентов (более 30 млн. наименований);
- Поставка сложных, дефицитных, либо снятых с производства позиций;
- Оперативные сроки поставки под заказ (от 5 рабочих дней);
- Экспресс доставка в любую точку России;
- Помощь Конструкторского Отдела и консультации квалифицированных инженеров;
- Техническая поддержка проекта, помощь в подборе аналогов, поставка прототипов;
- Поставка электронных компонентов под контролем ВП;
- Система менеджмента качества сертифицирована по Международному стандарту ISO 9001;
- При необходимости вся продукция военного и аэрокосмического назначения проходит испытания и сертификацию в лаборатории (по согласованию с заказчиком);
- Поставка специализированных компонентов военного и аэрокосмического уровня качества (Xilinx, Altera, Analog Devices, Intersil, Interpoint, Microsemi, Actel, Aeroflex, Peregrine, VPT, Syfer, Eurofarad, Texas Instruments, MS Kennedy, Miteq, Cobham, E2V, MA-COM, Hittite, Mini-Circuits, General Dynamics и др.);

Компания «Океан Электроники» является официальным дистрибьютором и эксклюзивным представителем в России одного из крупнейших производителей разъемов военного и аэрокосмического назначения «JONHON», а так же официальным дистрибьютором и эксклюзивным представителем в России производителя высокотехнологичных и надежных решений для передачи СВЧ сигналов «FORSTAR».



## JONHON

«JONHON» (основан в 1970 г.)

Разъемы специального, военного и аэрокосмического назначения:

(Применяются в военной, авиационной, аэрокосмической, морской, железнодорожной, горно- и нефтедобывающей отраслях промышленности)

«FORSTAR» (основан в 1998 г.)

ВЧ соединители, коаксиальные кабели, кабельные сборки и микроволновые компоненты:

(Применяются в телекоммуникациях гражданского и специального назначения, в средствах связи, РЛС, а так же военной, авиационной и аэрокосмической отраслях промышленности).



Телефон: 8 (812) 309-75-97 (многоканальный)

Факс: 8 (812) 320-03-32

Электронная почта: [ocean@oceanchips.ru](mailto:ocean@oceanchips.ru)

Web: <http://oceanchips.ru/>

Адрес: 198099, г. Санкт-Петербург, ул. Калинина, д. 2, корп. 4, лит. А