

RoHS (Pb) HF 16R Series

Description

Littelfuse 16R Series Radial Leaded PTCs are designed to provide resettable overcurrent protection serving a wide range of electronics applications. With maximum 16 volts and maximum 100-ampere short circuit rating, they offer an ideal solution for USB protection.

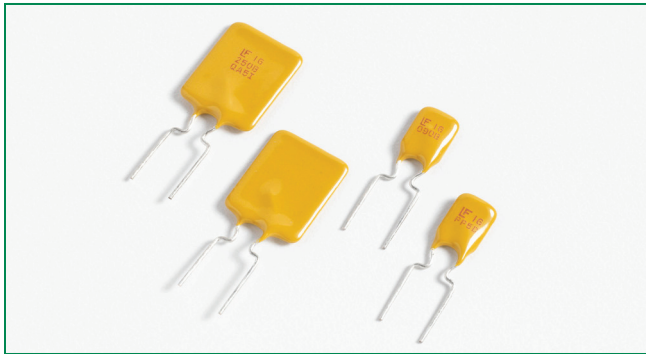

Features

- 100A short circuit rating
- 16V Operating voltages
- Fast time-to-trip
- Meets all USB protection requirements
- RoHS compliant, Lead-Free and Halogen-Free*



Applications

- Computers & peripherals
- Any USB application
- General Electronics

Agency Approvals

AGENCY	AGENCY FILE NUMBER
	E183209
	R50119318

Electrical Characteristics

Part Number	I_{hold} (A)	I_{trip} (A)	V_{max} (Vdc)	I_{max} (A)	P_d typ. (W)	Maximum Time To Trip		Resistance		Agency Approvals	
						Current (A)	Time (Sec.)	R_{min} (Ω)	R_{1max} (Ω)		
16R250G	2.5	4.7	16	100	1.0	12.5	5.0	0.0220	0.0530	X	X
16R300G	3.0	5.1	16	100	2.3	15.0	1.0	0.0380	0.0975	X	X
16R400G	4.0	6.8	16	100	2.4	20.0	1.7	0.0210	0.0600	X	X
16R500G	5.0	8.5	16	100	2.6	25.0	2.0	0.0150	0.0340	X	X
16R600G	6.0	10.2	16	100	2.8	30.0	3.3	0.0100	0.0280	X	X
16R700G	7.0	11.9	16	100	3.0	35.0	3.5	0.0077	0.0200	X	X
16R800G	8.0	13.6	16	100	3.0	40.0	5.0	0.0056	0.0175	X	X
16R900G	9.0	15.3	16	100	3.3	45.0	5.5	0.0047	0.0135	X	X
16R1000G	10.0	17.0	16	100	3.6	50.0	6.0	0.0040	0.0102	X	X
16R1100G	11.0	18.7	16	100	3.7	55.0	7.0	0.0037	0.0089	X	X
16R1200G	12.0	20.4	16	100	4.2	60.0	7.5	0.0033	0.0086	X	X
16R1400G	14.0	23.8	16	100	4.6	70.0	9.0	0.0026	0.0064	X	X

I_{hold} = Hold current: maximum current device will pass without tripping in 23°C still air.

I_{trip} = Trip current: minimum current at which the device will trip in 23°C still air.

V_{max} = Maximum voltage device can withstand without damage at rated current (I_{max})

I_{max} = Maximum fault current device can withstand without damage at rated voltage (V_{max})

P_d = Power dissipated from device when in the tripped state at 23°C still air.

R_{min} = Minimum resistance of device in initial (un-soldered) state.

R_{1max} = Maximum resistance of device at 23°C measured one hour after tripping.

Caution: Operation beyond the specified rating may result in damage and possible arcing and flame.

* Effective January 1, 2010, all 16R PTC products will be manufactured Halogen Free (HF). Existing Non-Halogen Free 16R PTC products may continue to be sold, until supplies are depleted.

Temperature Derating

Part Number	Ambient Operation Temperature								
	-40°C	-20°C	0°C	23°C	40°C	50°C	60°C	70°C	85°C
16R250G	3.7	3.3	2.9	2.5	2.2	2.0	1.8	1.6	1.3
16R300G	4.4	4.0	3.5	3.0	2.6	2.4	2.1	1.9	1.6
16R400G	5.9	5.3	4.7	4.0	3.5	3.2	2.9	2.6	2.1
16R500G	7.4	6.6	5.9	5.0	4.4	4.0	3.6	3.2	2.6
16R600G	8.9	8.0	7.1	6.0	5.2	4.8	4.3	3.9	3.2
16R700G	10.4	9.3	8.2	7.0	6.1	5.6	5.0	4.5	3.7
16R800G	11.8	10.6	9.4	8.0	7.0	6.3	5.7	5.1	4.2
16R900G	13.3	12.0	10.6	9.0	7.8	7.1	6.5	5.8	4.7
16R1000G	14.8	13.3	11.8	10.0	8.7	7.9	7.1	6.4	5.3
16R1100G	16.3	14.6	12.9	11.0	9.6	8.7	7.9	7.0	5.8
16R1200G	17.7	15.9	14.1	12.0	10.5	9.5	8.6	7.7	6.3
16R1400G	20.7	18.6	16.5	14.0	12.2	11.1	10.0	9.0	7.4

Average Time Current Curves

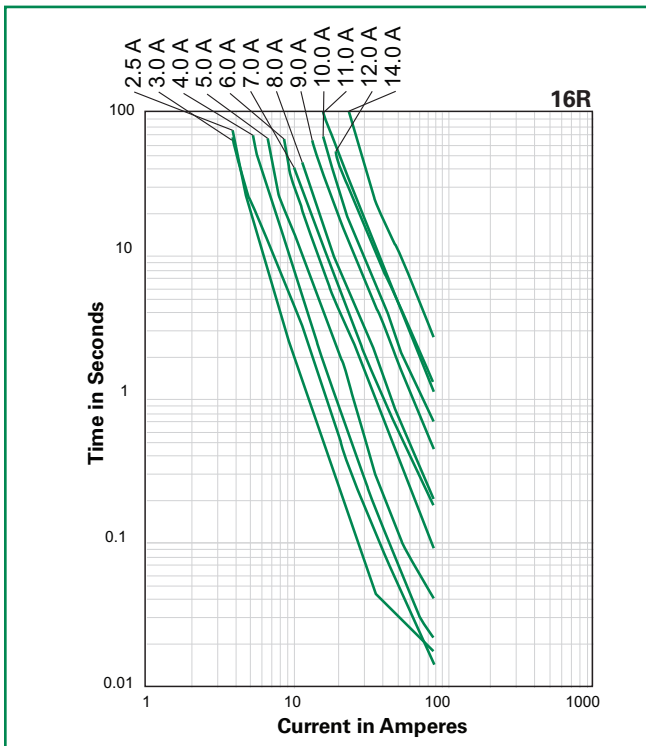

Temperature Derating Curve

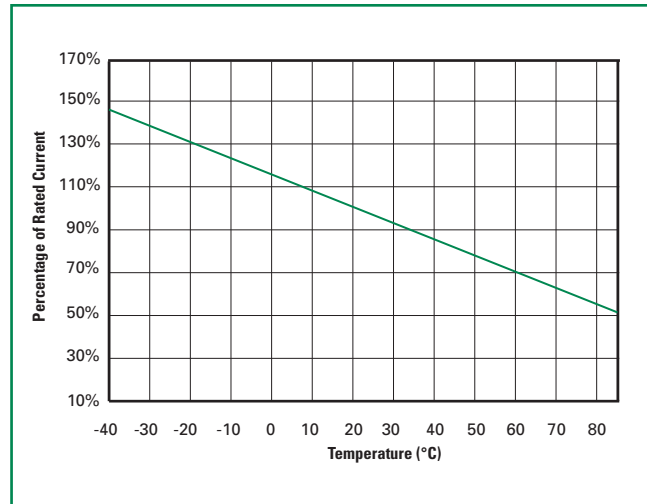

The average time current curves and Temperature Derating curve performance is affected by a number of variables, and these curves provided as guidance only. Customer must verify the performance in their application.

Soldering Parameters - Wave Soldering

Pre-Heating Zone	Refer to the condition recommended by the flux manufacturer. Max. ramping rate should not exceed 4°C/Sec.
Soldering Zone	Max. solder temperature should not exceed 260°C
Cooling Zone	Cooling by natural convection in air.

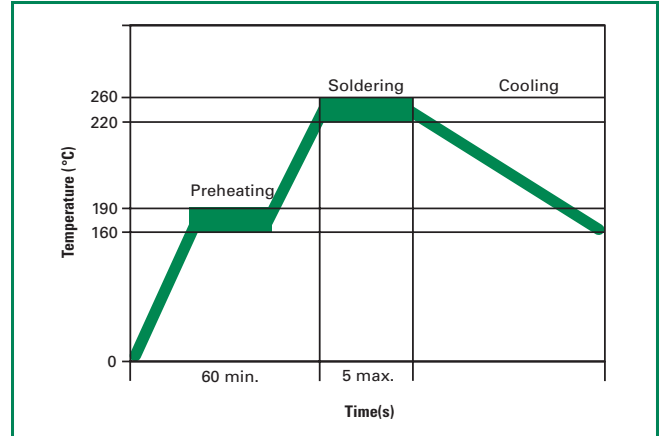

Physical Specifications

Lead Material	2.5A: Tin-plated Copper clad Steel 3.0 - 14.0A: Tin-plated Copper
Soldering Characteristics	Solderability per MIL-STD-202, Method 208E
Insulating Material	Cured, flame retardant epoxy polymer meets UL94V-0 requirements.
Device Labeling	Marked with 'LF', voltage, current rating, and date code.

Environmental Specifications

Operating/Storage Temperature	-40°C to +85°C
Maximum Device Surface Temperature in Tripped State	125°C
Passive Aging	+85°C, 1000 hours -/+ 5% typical resistance change
Humidity Aging	+85°C, 85% R.H., 1000 hours -/+ 5% typical resistance change
Thermal Shock	+85°C to -40°C 10 times -/+ 5% typical resistance change
Solvent Resistance	MIL-STD-202, Method 215F No change
Moisture Resistance Level	Level 1, J-STD-020C

Dimensions

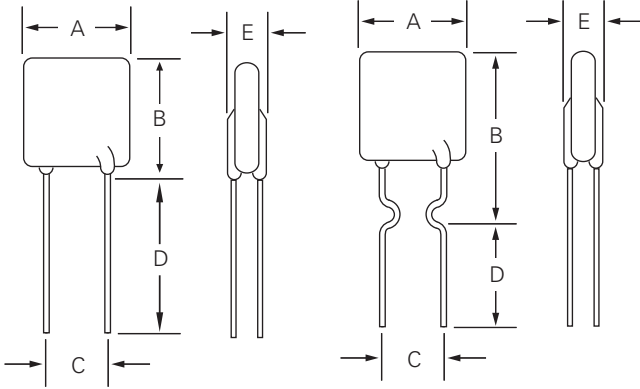
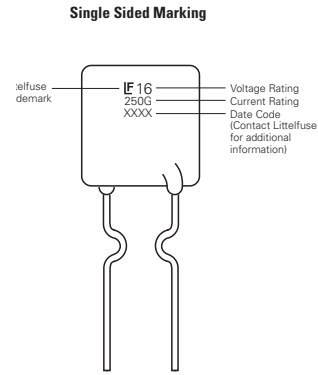

Figure 1

Figure 2

Part Marking System

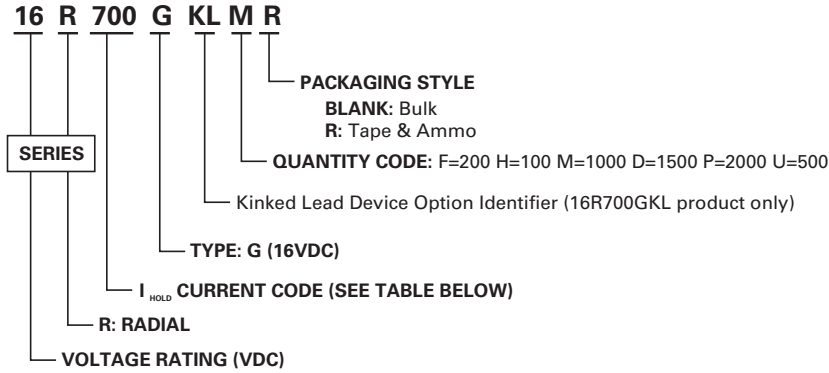

Part Number	Figure	A		B		C		D		E		Physical Characteristics		
		Inches	mm	Inches	mm	Inches	mm	Inches	mm	Inches	mm	Lead (dia)		Material
		Max.	Max.	Max.	Max.	Typ.	Typ.	Min.	Min.	Max.	Max.	Inches	mm	
16R250G	2	0.35	8.90	0.50	12.80	0.20	5.1	0.13	3.18	0.12	3.00	0.020	0.51	Sn/CuFe
16R300G	1	0.28	7.10	0.43	11.00	0.20	5.1	0.30	7.6	0.12	3.00	0.032	0.81	Sn/Cu
16R400G	1	0.35	8.90	0.50	12.80	0.20	5.1	0.30	7.6	0.12	3.00	0.032	0.81	Sn/Cu
16R500G	1	0.41	10.40	0.56	14.30	0.20	5.1	0.30	7.6	0.12	3.00	0.032	0.81	Sn/Cu
16R600G	1	0.42	10.70	0.67	17.10	0.20	5.1	0.30	7.6	0.12	3.00	0.032	0.81	Sn/Cu
16R700G	1	0.44	11.20	0.78	19.70	0.20	5.1	0.30	7.6	0.12	3.00	0.032	0.81	Sn/Cu
16R700GKL	2	0.44	11.20	0.93	23.70	0.20	5.1	0.30	7.6	0.12	3.00	0.032	0.81	Sn/Cu
16R800G	1	0.50	12.70	0.82	20.90	0.20	5.1	0.30	7.6	0.12	3.00	0.032	0.81	Sn/Cu
16R900G	1	0.55	14.00	0.85	21.70	0.20	5.1	0.30	7.6	0.12	3.00	0.032	0.81	Sn/Cu
16R1000G	1	0.65	16.50	0.99	25.20	0.20	5.1	0.30	7.6	0.12	3.00	0.032	0.81	Sn/Cu
16R1100G	1	0.69	17.50	1.02	26.00	0.20	5.1	0.30	7.6	0.12	3.00	0.032	0.81	Sn/Cu
16R1200G	1	0.69	17.50	1.10	28.00	0.40	10.2	0.30	7.6	0.14	3.50	0.039	1.00	Sn/Cu
16R1400G	1	0.93	23.50	1.10	27.90	0.40	10.2	0.30	7.6	0.14	3.50	0.039	1.00	Sn/Cu

Part Ordering Number System

Packaging Options

Part Number	Ordering Number	I _{hold} (A)	I _{hold} Code	Packaging Option	Quantity	Quantity & Packaging Codes
16R250G	16R250GU	2.50	250	Bulk	500	U
	16R250GPR			Tape and Ammo	2000	PR
16R300G	16R300GU	3.00	300	Bulk	500	U
	16R300GPR			Tape and Ammo	2000	PR
16R400G	16R400GU	4.00	400	Bulk	500	U
	16R400GPR			Tape and Ammo	2000	PR
16R500G	16R500GU	5.00	500	Bulk	500	U
	16R500GPR			Tape and Ammo	2000	PR
16R600G	16R600GU	6.00	600	Bulk	500	U
	16R600GDR			Tape and Ammo	1500	DR
16R700G	16R700GF	7.00	700	Bulk	200	F
	16R700GKLF			Tape and Ammo	1000	MR
	16R700GMR					
	16R700GKLMR					
16R800G	16R800GF	8.00	800	Bulk	200	F
	16R800GMR			Tape and Ammo	1000	MR
16R900G	16R900GF	9.00	900	Bulk	200	F
	16R900GMR			Tape and Ammo	1000	MR
16R1000G	16R1000GF	10.00	1000	Bulk	200	F
	16R1000GMR			Tape and Ammo	1000	MR
16R1100G	16R1100GF	11.00	1100	Bulk	200	F
	16R1100GMR			Tape and Ammo	1000	MR
16R1200G	16R1200GH	12.00	1200	Bulk	100	H
	16R1200GMR			Tape and Ammo	1000	MR
16R1400G	16R1400GH	14.00	1400	Bulk	100	H

Tape and Ammo Specifications

Devices taped using EIA468-B/IE286-2 standards. See table below and Figure 1 for details.

Dimension	EIA Mark	IEC Mark	Dimensions	
			Dim. (mm)	Tol. (mm)
Carrier tape width	W	W	18	-0.5 / +1.0
Hold down tape width:	W₄	W₀	11	min.
Top distance between tape edges	W₆	W₂	3	max.
Sprocket hole position	W₅	W₁	9	-0.5 / +0.75
Sprocket hole diameter*	D₀	D₀	4	-0.32 / +0.2
Abscissa to plane(straight lead)	H	H	18.5	-/+ 3.0
Abscissa to plane(kinked lead)	H₀	H₀	16	-/+ 0.5
Abscissa to top			45.0	max.
Overall width w/o lead protrusion			56	max.
Overall width w/ lead protrusion			57	max.
Lead protrusion	L₁	I₁	1.0	max.
Protrusion of cut out	L	L	11	max.
Protrusion beyond hold-down tape	I₂	I₂	Not specified	
Sprocket hole pitch	P₀	P₀	25.4	-/+ 0.5
Device pitch:			25.4	
Pitch tolerance			20 consecutive.	-/+ 1
Tape thickness	t	t	0.9	max.
Tape thickness with splice	t₁		2.0	max.
Splice sprocket hole alignment			0	-/+ 0.3
Body lateral deviation	Δh	Δh	0	-/+ 1.0
Body tape plane deviation	Δp	Δp	0	-/+ 1.3
Ordinate to adjacent component lead*	P₁	P₁	3.81	-/+ 0.7
Ordinate to adjacent component lead*			7.62	-/+ 0.7
Lead spacing:16R250G-16R1100G	F	F	5.08	-/+ 0.8
Lead spacing:16R1200G-16R1400G	F	F	10.18	-/+ 0.8

*Differs from EIA specification

Tape and Ammo Diagram

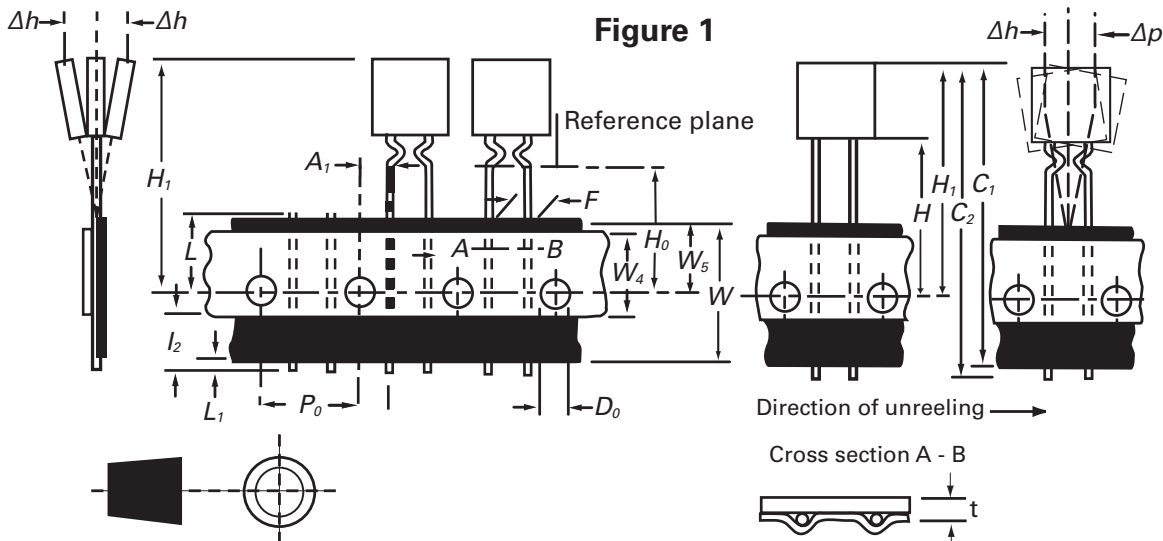

Компания «Океан Электроники» предлагает заключение долгосрочных отношений при поставках импортных электронных компонентов на взаимовыгодных условиях!

Наши преимущества:

- Поставка оригинальных импортных электронных компонентов напрямую с производств Америки, Европы и Азии, а так же с крупнейших складов мира;
- Широкая линейка поставок активных и пассивных импортных электронных компонентов (более 30 млн. наименований);
- Поставка сложных, дефицитных, либо снятых с производства позиций;
- Оперативные сроки поставки под заказ (от 5 рабочих дней);
- Экспресс доставка в любую точку России;
- Помощь Конструкторского Отдела и консультации квалифицированных инженеров;
- Техническая поддержка проекта, помощь в подборе аналогов, поставка прототипов;
- Поставка электронных компонентов под контролем ВП;
- Система менеджмента качества сертифицирована по Международному стандарту ISO 9001;
- При необходимости вся продукция военного и аэрокосмического назначения проходит испытания и сертификацию в лаборатории (по согласованию с заказчиком);
- Поставка специализированных компонентов военного и аэрокосмического уровня качества (Xilinx, Altera, Analog Devices, Intersil, Interpoint, Microsemi, Actel, Aeroflex, Peregrine, VPT, Syfer, Eurofarad, Texas Instruments, MS Kennedy, Miteq, Cobham, E2V, MA-COM, Hittite, Mini-Circuits, General Dynamics и др.);

Компания «Океан Электроники» является официальным дистрибьютором и эксклюзивным представителем в России одного из крупнейших производителей разъемов военного и аэрокосмического назначения «JONHON», а так же официальным дистрибьютором и эксклюзивным представителем в России производителя высокотехнологичных и надежных решений для передачи СВЧ сигналов «FORSTAR».



JONHON

«JONHON» (основан в 1970 г.)

Разъемы специального, военного и аэрокосмического назначения:

(Применяются в военной, авиационной, аэрокосмической, морской, железнодорожной, горно- и нефтедобывающей отраслях промышленности)

«FORSTAR» (основан в 1998 г.)

ВЧ соединители, коаксиальные кабели,
кабельные сборки и микроволновые компоненты:

(Применяются в телекоммуникациях гражданского и специального назначения, в средствах связи, РЛС, а так же военной, авиационной и аэрокосмической отраслях промышленности).



Телефон: 8 (812) 309-75-97 (многоканальный)

Факс: 8 (812) 320-03-32

Электронная почта: ocean@oceanchips.ru

Web: <http://oceanchips.ru/>

Адрес: 198099, г. Санкт-Петербург, ул. Калинина, д. 2, корп. 4, лит. А