

ISL71010B50

Ultra Low Noise, 5V Precision Voltage Reference

FN8961
Rev.1.00
Apr 12, 2018

The [ISL71010B50](#) is an ultra low noise, high DC accuracy precision voltage reference, with a wide input voltage range from 7.0V to 30V. The ISL71010B50 uses the dielectrically isolated PR40 process to achieve $4.2\mu\text{V}_{\text{P-P}}$ noise at 0.1Hz to 10Hz with an initial voltage accuracy of $\pm 0.05\%$.

The ISL71010B50 offers a 5.0V output voltage with $10\text{ppm}/^\circ\text{C}$ temperature coefficient and also provides excellent line and load regulation. The device is offered in an 8 Ld SOIC package.

The ISL71010B50 is ideal for high-end instrumentation, data acquisition, and processing applications requiring high DC precision where low noise performance is critical.

Applications

- Low Earth Orbit (LEO)
- High altitude avionics
- Precision instruments
- Data acquisition systems for space applications
- Strain and pressure gauges for space applications
- Active sources for sensors

Features

- Reference output voltage: $5.0\text{V} \pm 0.05\%$
- Accuracy over temperature/radiation: $\pm 0.15\%$
- Output voltage noise: $4.2\mu\text{V}_{\text{P-P}}$ typical (0.1Hz to 10Hz)
- Supply current: $930\mu\text{A}$ (typical)
- Temperature coefficient: $10\text{ppm}/^\circ\text{C}$ (maximum)
- Output current capability: 20mA
- Line regulation: $20\text{ppm}/\text{V}$ (maximum)
- Load regulation: $17\text{ppm}/\text{mA}$ (maximum)
- NiPdAu-Ag lead finish (Sn Free)
- Dielectrically isolated PR40 process
- Operating temperature range: -55°C to $+125^\circ\text{C}$
- Passes NASA Low Outgassing Specifications
- Characterized radiation level
 - Low dose rate (10mrad(Si): 30krad(Si)
 - Single event burnout LET: $43\text{MeV}\cdot\text{cm}^2/\text{mg}$

Related Literature

For a full list of related documents, visit our website

- [ISL71010B50](#) product page.

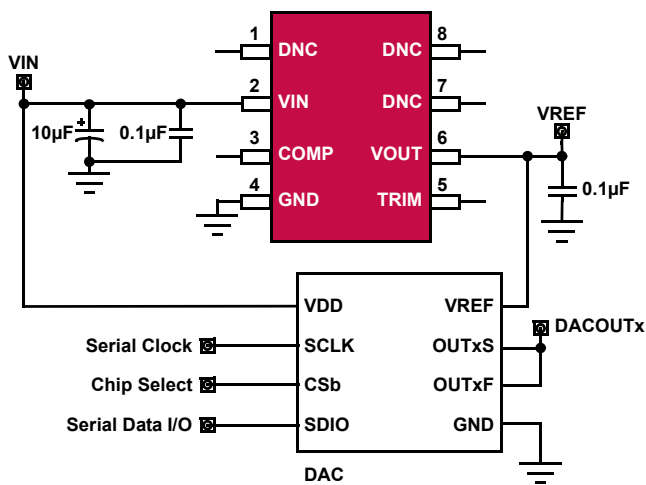

Figure 1. ISL71010B50 Typical Application Diagram

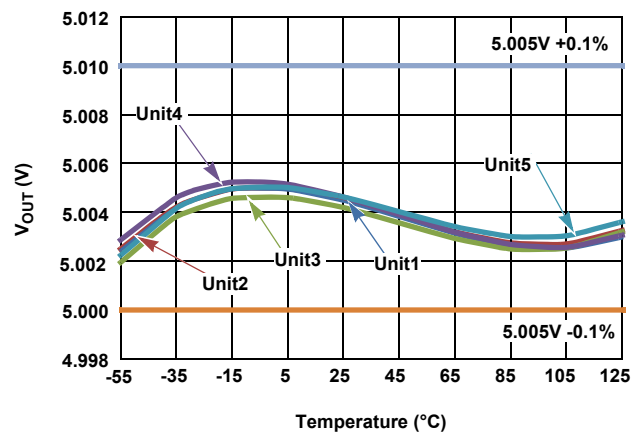

Figure 2. V_{OUT} vs Temperature

1. Overview

1.1 Functional Block Diagram

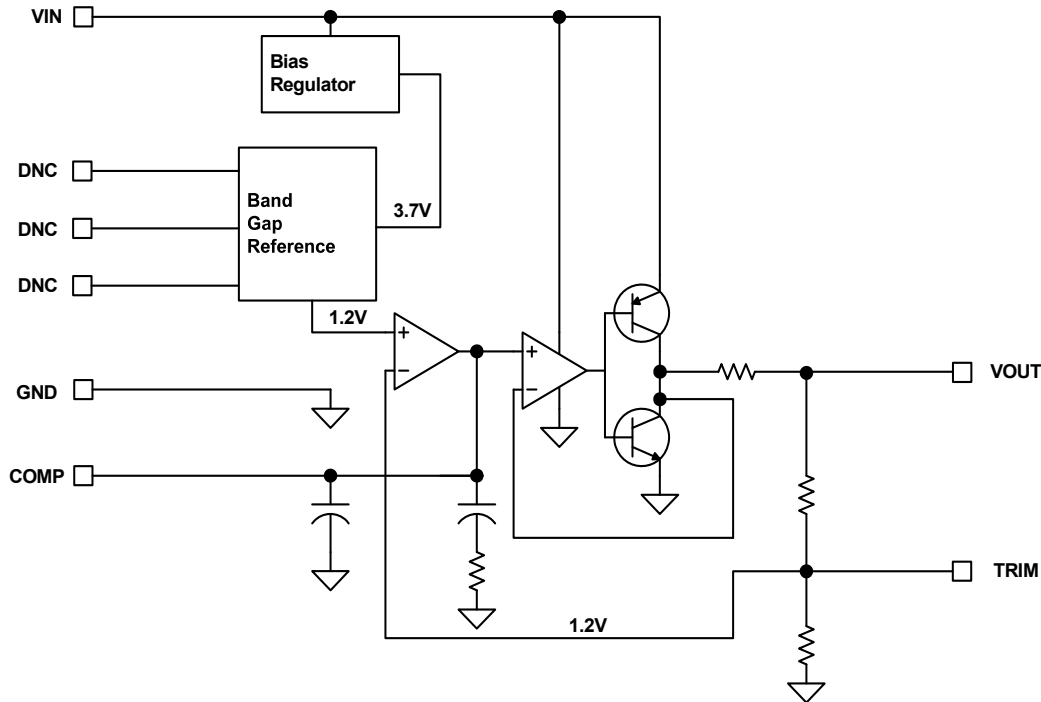

Figure 3. Functional Block Diagram

1.2 Ordering Information

Part Number (Notes 1, 2, 3)	Part Marking	V _{OUT} Option (V)	Accuracy (%)	Tempco (ppm/°C)	Temp Range (°C)	Tape and Reel (Units)	Package (RoHS Compliant)	Pkg. Dwg. #
ISL71010BMB50Z	71010 BMZ50	5.0	±0.05	10	-55 to +125	-	8 Ld SOIC	M8.15
ISL71010BMB50Z-TK (Note 1)	71010 BMZ50	5.0	±0.05	10	-55 to +125	1k	8 Ld SOIC	M8.15
ISL71010BM50EV1Z	Evaluation Board							

Notes:

1. Refer to [TB347](#) for details about reel specifications.
2. These Pb-free plastic packaged products employ special Pb-free material sets, molding compounds/die attach materials and NiPdAu-Ag plate -e4 termination finish, which is RoHS compliant and compatible with both SnPb and Pb-free soldering operations. Pb-free products are MSL classified at Pb-free peak reflow temperatures that meet or exceed the Pb-free requirements of IPC/JEDEC J STD-020.
3. For Moisture Sensitivity Level (MSL), see the [ISL71010B50](#) product information page. For more information about MSL, refer to [TB363](#).

1.3 Pin Configuration

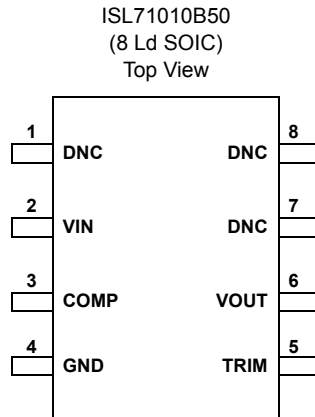

1.4 Pin Descriptions

Pin Number	Pin Name	ESD Circuit	Description
1, 7, 8	DNC	3	Do not connect. Internally terminated.
2	VIN	1	Input voltage connection
3	COMP	2	Compensation and noise reduction capacitor
4	GND	1	Ground connection.
5	TRIM	2	Voltage reference trim input
6	VOUT	2	Voltage reference output

ESD Circuit 1: VIN is connected to a diode (anode to VIN, cathode to GND) and a capacitively triggered clamp. The other side of the clamp is connected to GND.

ESD Circuit 2: VIN is connected to a diode (anode to VIN, cathode to GND) and another diode (anode to GND, cathode to VIN). Pins 3, 5, and 6 are connected to the node between the two diodes.

ESD Circuit 3: VIN is connected to a diode (anode to VIN, cathode to DNC) and another diode (anode to DNC, cathode to VIN). The other side of the second diode is connected to GND.

2. Specifications

2.1 Absolute Maximum Ratings

Parameter	Minimum	Maximum	Unit
Max Voltage			
V _{IN} to GND	-0.5	+40	V
V _{OUT} to GND (10s)	-0.5	V _{OUT} + 0.5	V
Voltage on any Pin to Ground	-0.5	+V _{OUT} + 0.5	V
Voltage on DNC pins	No connections permitted to these pins		
Input Voltage Slew Rate (Max)		0.1	V/μs
ESD Rating	Value		Unit
Human Body Model (Tested per JS-001-2014)	3		kV
Machine Model (Tested per JESD22-A115-C)	200		V
Charged Device Model (Tested per JS-002-2014)	2		kV
Latch-up (Tested per JESD-78E; Class 2, Level A, at +125°C)	±100		mA

CAUTION: Do not operate at or near the maximum ratings listed for extended periods of time. Exposure to such conditions may adversely impact product reliability and result in failures not covered by warranty.

2.2 Outgas Testing

Specification (Tested per ASTM E 595, 1.5)	Value	Unit
Total Mass Lost (Note 4)	0.06	%
Collected Volatile Condensable Material (Note 4)	<0.01	%
Water Vapor Recovered	0.03	%

Notes:

- Results meet NASA low outgassing requirements of "Total Mass Lost" of <1% and "Collected Volatile Condensable Material" of <0.1%.

2.3 Thermal Information

Thermal Resistance (Typical)	θ _{JA} (°C/W)	θ _{JC} (°C/W)
8 Ld SOIC Package (Notes 5, 6)	110	60

Notes:

- θ_{JA} is measured with the component mounted on a high-effective thermal conductivity test board in free air. See [TB379](#).
- For θ_{JC}, the "case temp" location is taken at the package top center.

Parameter	Minimum	Maximum	Unit
Continuous Power Dissipation (T _A = +125°C)		217	mW
Maximum Junction Temperature (T _{JMAX})		+150	°C
Storage Temperature Range	-65	+150	°C
Pb-Free Reflow Profile	Refer to TB493		

2.4 Recommended Operating Conditions

Parameter	Minimum	Maximum	Unit
V_{IN}	7.0	+30	V
Temperature Range	-55	+125	°C

2.5 Electrical Specifications

$V_{IN} = 10V$, $I_{OUT} = 0mA$, $C_{OUT} = 0.1\mu F$, $COMP = 1nF$ unless otherwise specified. **Boldface limits apply across the operating temperature range, -55°C to +125°C.**

Parameter	Symbol	Conditions	Min (Note 8)	Typ	Max (Note 8)	Unit
Output Voltage	V_{OUT}	$V_{IN} = 10V$		5.0		V
V_{OUT} Accuracy at $T_A = +25^\circ C$	V_{OA}	$V_{OUT} = 5.0V$, (Note 7)	-0.05		+0.05	%
V_{OUT} Accuracy at $T_A = -55^\circ C$ to $+125^\circ C$		$V_{OUT} = 5.0V$, (Note 7)	-0.15		+0.15	%
Output Voltage Temperature Coefficient (Note 9)	$TC V_{OUT}$				10	ppm/°C
Input Voltage Range	V_{IN}	$V_{OUT} = 5.0V$	7		30	V
Supply Current	I_{IN}			0.930	1.33	mA
Line Regulation	$\Delta V_{OUT} / \Delta V_{IN}$	$V_{IN} = 7V$ to $30V$, $V_{OUT} = 5.0V$		8	20	ppm/V
Load Regulation	$\Delta V_{OUT} / \Delta I_{OUT}$	Sourcing: $0mA \leq I_{OUT} \leq 20mA$		2.5	17	ppm/mA
		Sinking: $-10mA \leq I_{OUT} \leq 0mA$		2.5	17	ppm/mA
Dropout Voltage (Note 10)	V_D	$V_{OUT} = 5.0V$ at 10mA		1.1	1.7	V
Short-Circuit Current	I_{SC+}	$T_A = +25^\circ C$, V_{OUT} tied to GND		54	75	mA
Short-Circuit Current	I_{SC-}	$T_A = +25^\circ C$, V_{OUT} tied to V_{IN}	-100	-60		mA
Turn-On Settling Time	t_R	90% of final value, $C_L = 1.0\mu F$, $C_C = Open$		150		μs
Ripple Rejection		$f = 120Hz$		90		dB
Output Voltage Noise	e_{np-p}	$0.1Hz \leq f \leq 10Hz$, $V_{OUT} = 5.0V$		4.2		μV_{P-P}
Broadband Voltage Noise	V_n	$10Hz \leq f \leq 1kHz$, $V_{OUT} = 5.0V$		3.2		μV_{RMS}
Noise Voltage Density	e_n	$f = 1kHz$, $V_{OUT} = 5.0V$		100		nV/ \sqrt{Hz}
Long Term Stability	$\Delta V_{OUT} / \Delta t$	$T_A = +25^\circ C$		20		ppm

Notes:

- Post-reflow drift for the ISL71010B50 devices can exceed 100 μV to 1.0mV based on experimental results with devices on FR4 double sided boards. The system engineer must take this into account when considering the reference voltage after assembly.
- Compliance to datasheet limits is assured by one or more methods: production test, characterization, and/or design.
- Over the specified temperature range. Temperature coefficient is measured by the box method whereby the change in V_{OUT} is divided by the temperature range; in this case, $-55^\circ C$ to $+125^\circ C = +180^\circ C$. See "[Specifying Temperature Coefficient \(Box Method\)](#)" on page 11 for more information.
- Dropout Voltage is the minimum $V_{IN} - V_{OUT}$ differential voltage measured at the point where V_{OUT} drops 1mV from $V_{IN} = nominal$ at $T_A = +25^\circ C$.

3. Typical Performance Curves

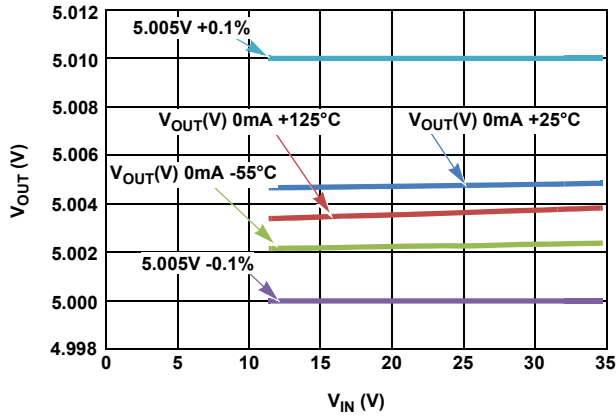

Figure 4. V_{OUT} Accuracy Over Temperature

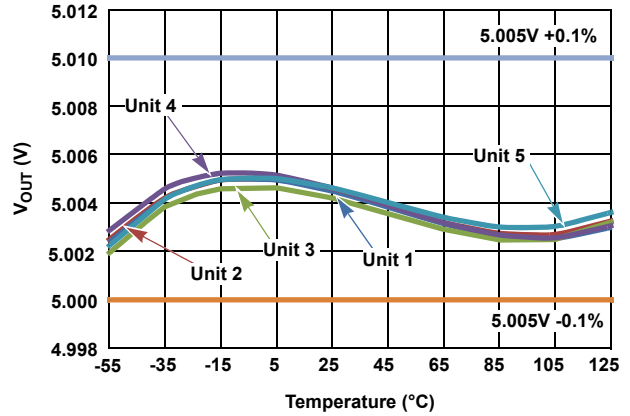

Figure 5. 5.005V V_{OUT} Limits Plot

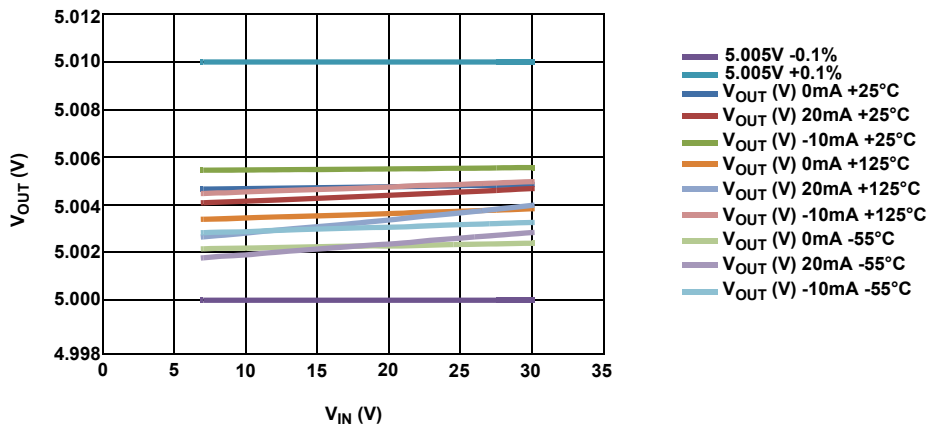

Figure 6. V_{OUT} vs V_{IN} AT 0mA, 20mA, and -10mA

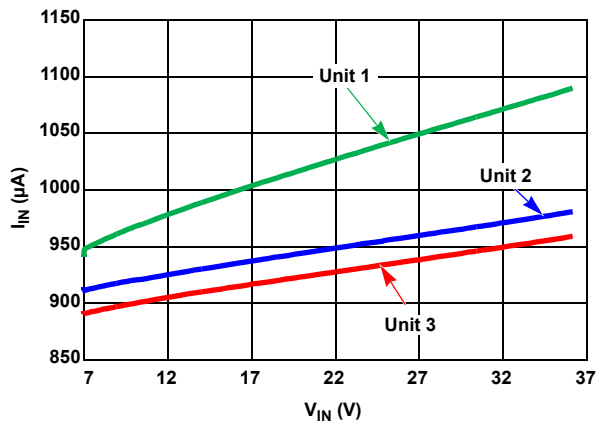

Figure 7. I_{IN} vs V_{IN} , Three Units

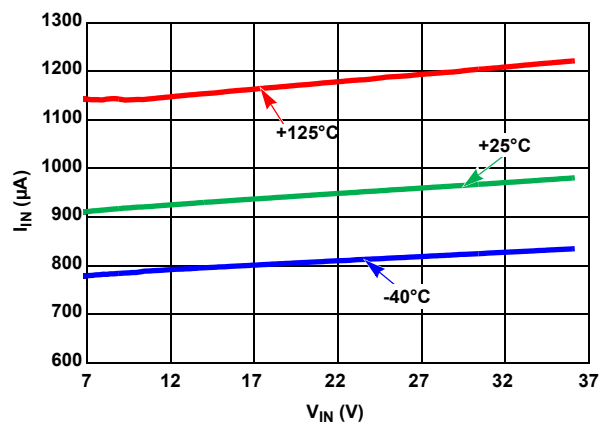

Figure 8. I_{IN} vs V_{IN} , Three Temperatures

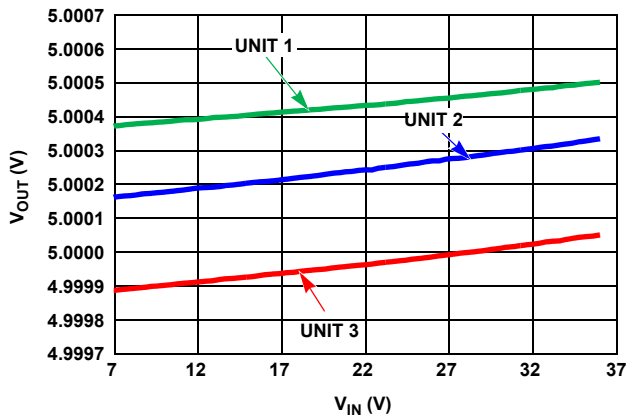

Figure 9. Line Regulation, Three Units

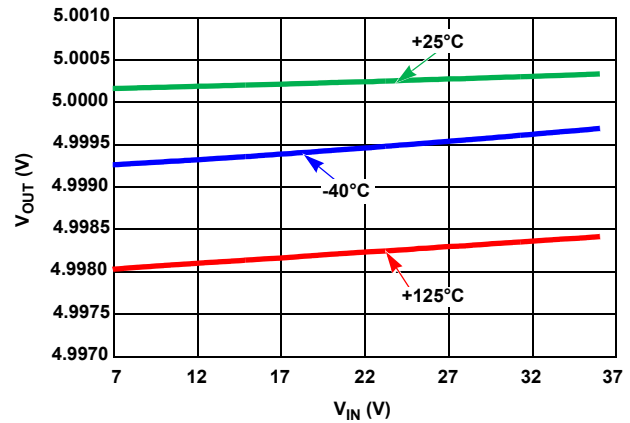

Figure 10. Line Regulation, Three Temperatures

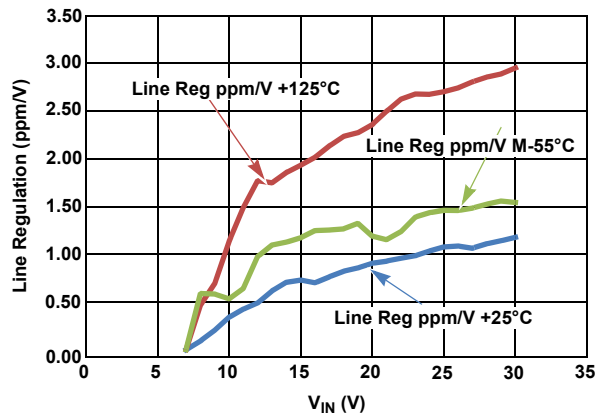

Figure 11. Line Regulation Over Temperature

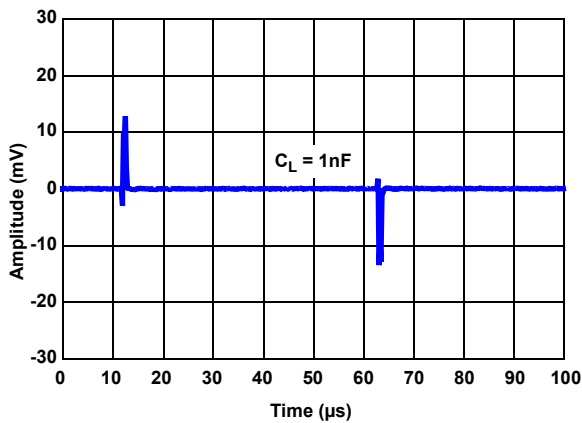

Figure 12. Line Transient with 1nF LOAD
($\Delta V_{IN} = \pm 500mV$)

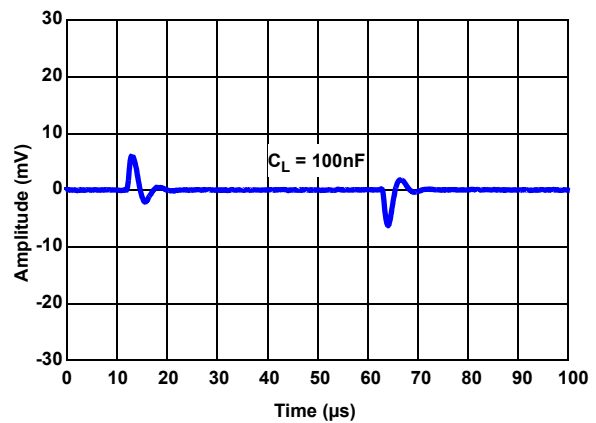

Figure 13. Line Transient with 100nF LOAD
($\Delta V_{IN} = \pm 500mV$)

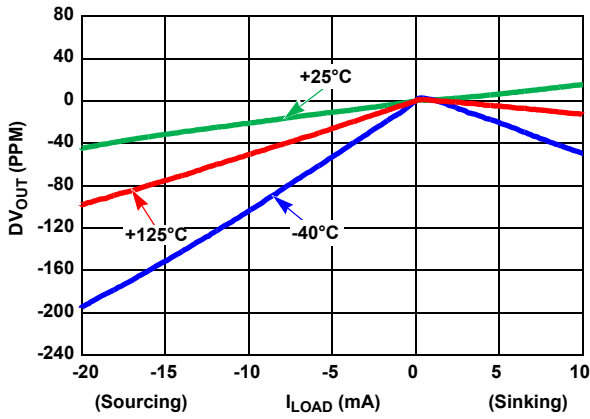

Figure 14. Load Regulation, Three Temperatures

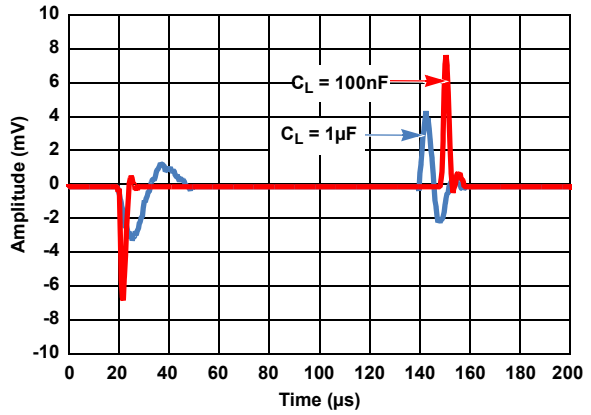

Figure 15. Load Transient ($\Delta I_{LOAD} = \pm 1mA$)

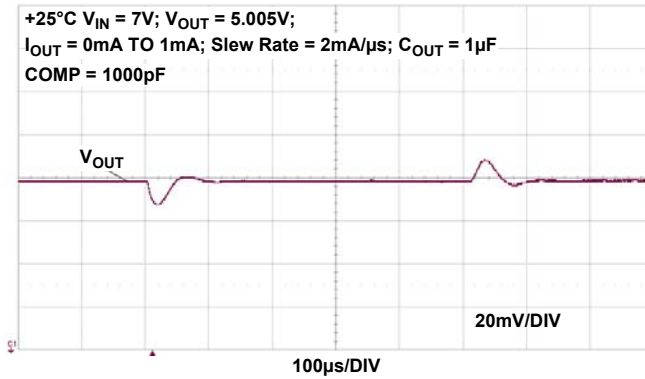

Figure 16. Load Transient (0mA to 1mA)

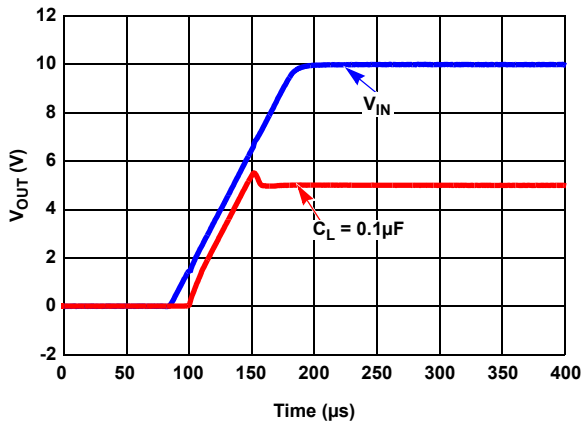

Figure 17. Turn-On Time with 0.1 μF

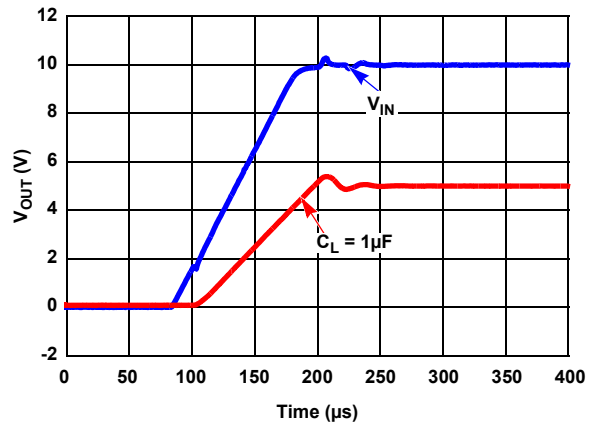

Figure 18. Turn-On Time with 1 μF

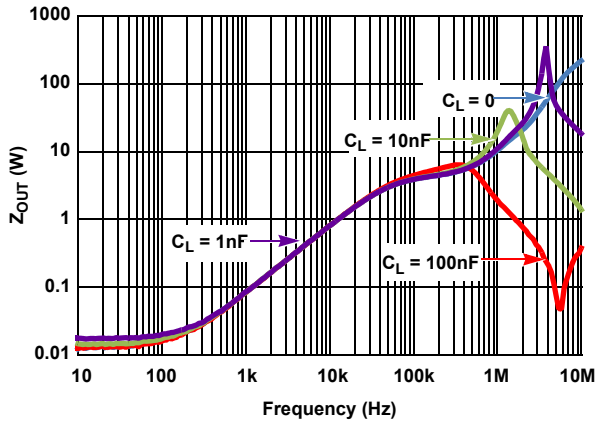

Figure 19. Z_{OUT} vs Frequency

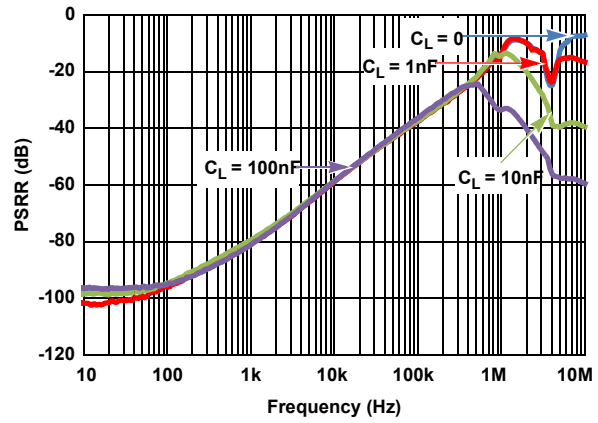

Figure 20. PSRR at Different Capacitive Loads

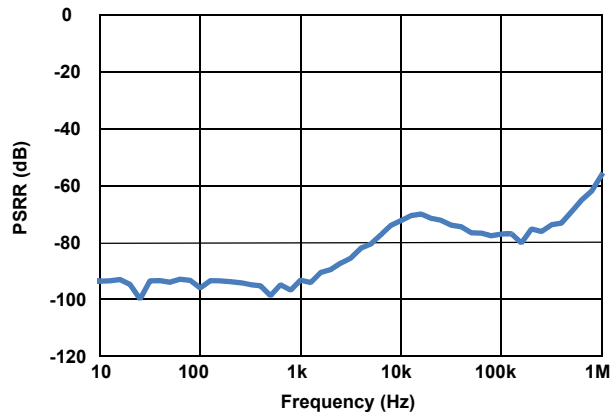

Figure 21. PSRR (+25°C, $V_{IN} = 7V$, $V_{OUT} = 5.005V$, $I_{OUT} = 0mA$, $C_{IN} = 0.1\mu F$, $C_{OUT} = 1.0\mu F$, $COMP = 1nF$, $V_{SIG} = 300mV_{P-P}$)

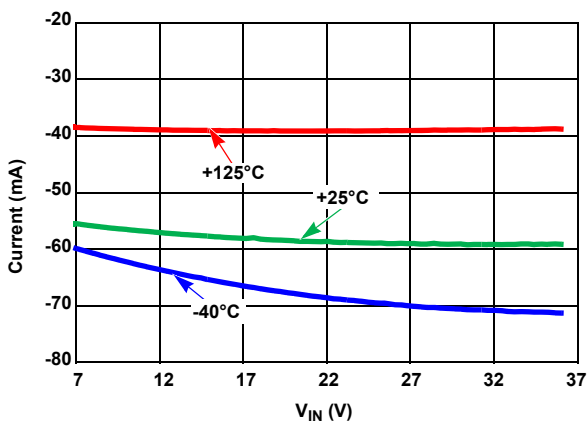

Figure 22. Short-Circuit to GND

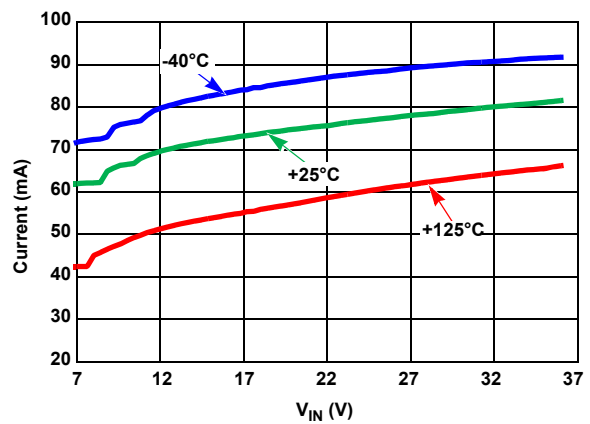

Figure 23. Short-Circuit to V_{IN}

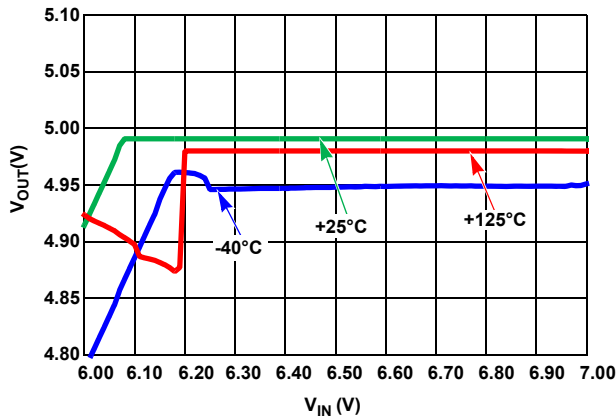

Figure 24. Dropout with -10mA Load

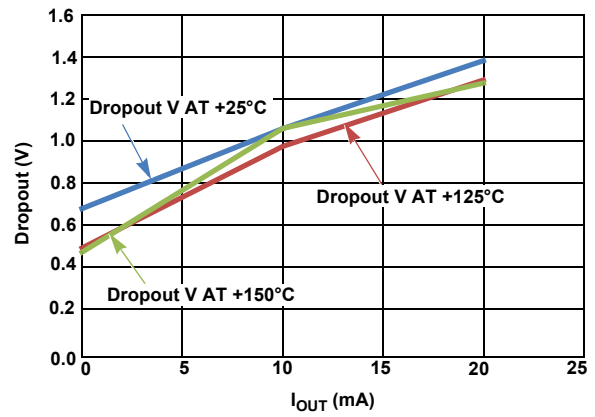

Figure 25. Dropout Voltage for 5.005V

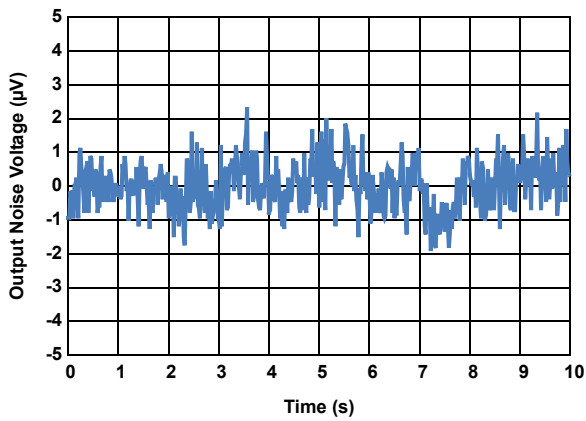

Figure 26. V_{OUT} vs Noise, 0.1Hz to 10Hz

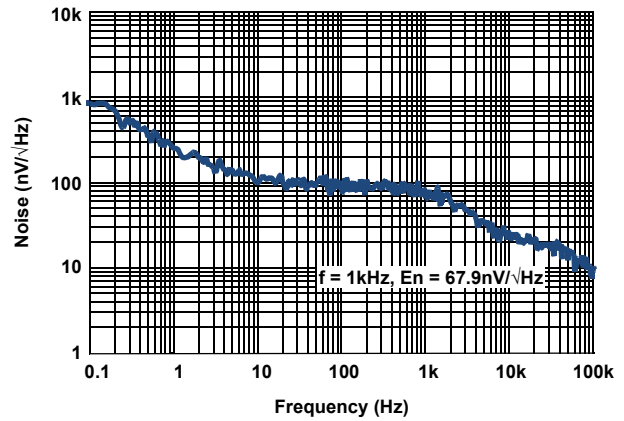

Figure 27. Noise Density vs Frequency ($V_{IN} = 7.1V$, $I_{OUT} = 0mA$, $C_{IN} = 0.1\mu F$, $C_{OUT} = 1\mu F$, $COMP = 1nF$)

4. Applications Information

4.1 Bandgap Precision Reference

The ISL71010B50 uses a bandgap architecture and special trimming circuitry to produce a temperature compensated, precision voltage reference with high input voltage capability and moderate output current drive.

4.2 Board Mounting Considerations

For applications requiring the highest accuracy, the board mounting location should be considered. The device uses a plastic SOIC package, which subjects the die to mild stresses when the Printed Circuit Board (PCB) is heated and cooled, which slightly changes the shape. Because of these die stresses, placing the device in areas subject to slight twisting can cause degradation of degrade the reference voltage accuracy. It is normally best to place the device near the edge of a board, or on the shortest side, because the axis of bending is most limited in that location. Mounting the device in a cutout also minimizes flex. Obviously, mounting the device on flexprint or extremely thin PC material will likewise cause loss of reference accuracy.

4.3 Board Assembly Considerations

Some PCB assembly precautions are necessary. Normal output voltage shifts of $100\mu\text{V}$ can be expected with Pb-free reflow profiles or wave solder on multi-layer FR4 PCBs. Precautions should be taken to avoid excessive heat or extended exposure to high reflow or wave solder temperatures.

4.4 Noise Performance and Reduction

The output noise voltage in a 0.1Hz to 10Hz bandwidth is typically $4.2\mu\text{V}_{\text{P-P}}$ ($V_{\text{OUT}} = 5.0\text{V}$). The noise measurement is made with a bandpass filter. The filter is made of a 1-pole high-pass filter, with a corner frequency at 0.1Hz, and a 2-pole low-pass filter, with a corner frequency (3dB) at 9.9Hz, to create a filter with a 9.9Hz bandwidth. Noise in the 10Hz to 1kHz bandwidth is approximately $3.2\mu\text{V}_{\text{RMS}}$, with 1 μF capacitance on the output. This noise measurement is made with a 2 decade bandpass filter. The filter is made of a 1-pole high-pass filter with a corner frequency at 10Hz of the center frequency, and 1-pole low-pass filter with a corner frequency at 1kHz. Load capacitance up to 10 μF can be added, but will result in only marginal improvements in output noise and transient response.

4.5 Turn-On Time

Normal turn-on time is typically 250 μs . The circuit designer must take this into account when looking at power-up delays or sequencing.

4.6 Specifying Temperature Coefficient (Box Method)

The limits stated for temperature coefficient (Tempco) are governed by the method of measurement. The overwhelming standard for specifying the temperature drift of a reference is to measure the reference voltage at two temperatures. Divide the total variation ($V_{\text{HIGH}} - V_{\text{LOW}}$) by the temperature extremes of measurement ($T_{\text{HIGH}} - T_{\text{LOW}}$). The result is divided by the nominal reference voltage (at $T = +25^{\circ}\text{C}$) and multiplied by 10^6 to yield ppm/ $^{\circ}\text{C}$. This is the “Box” method for specifying temperature coefficient.

4.7 Output Voltage Adjustment

The output voltage can be adjusted above and below the factory-calibrated value using the trim terminal. The trim terminal is the negative feedback divider point of the output operational amplifier. The voltage at the TRIM pin is set at approximately 1.216V by the internal bandgap and amplifier circuitry of the voltage reference.

The suggested method to adjust the output is to connect a 1M Ω external resistor directly to the trim terminal and connect the other end to the wiper of a potentiometer that has a 100k Ω resistance and with outer terminals that connect to V_{OUT} and ground. If a 1M Ω resistor is connected to trim, the output adjust range will be $\pm 6.3\text{mV}$. The TRIM pin should not have any capacitor tied to its output. Also it is important to minimize the capacitance on the trim terminal during layout to preserve output amplifier stability. It is also best to connect the series resistor

directly to the trim terminal, to minimize that capacitance and also to minimize noise injection. Small trim adjustments will not disturb the factory-set temperature coefficient of the reference, but trimming near the extreme values can.

4.8 Output Stage

The output stage of the device has a push pull configuration with a high-side PNP and a low-side NPN. This helps the device to act as a source and sink. The device can source 20mA.

4.9 Use of COMP Capacitors

The reference can be compensated for the C_{OUT} capacitors used by adding a capacitor from COMP pin to GND. See [Table 1](#) for recommended values of the COMP capacitor.

Table 1. COMP Capacitor Recommended Values

C_{OUT} (μ F)	C_{COMP} (nF)
0.1	1
1	1
10	10

5. Radiation Tolerance

The ISL71010B50 is a radiation tolerant device for commercial space applications, Low Earth Orbit (LEO) applications, high altitude avionics, launch vehicles, and other harsh environments. This device's response to Total Ionizing Dose (TID) radiation effects and Single-Event Effects (SEE) has been measured, characterized, and reported in the following sections. However, TID performance is not guaranteed through radiation acceptance testing, nor is the SEE characterized performance guaranteed.

5.1 Total Ionizing Dose (TID) Testing

5.1.1 Introduction

This test was conducted to determine the sensitivity of the part to the total dose environment. Down points were 0krad(Si), 10krad(Si), and 30krad(Si). Reference the [ISL71010B25](#) datasheet for additional down point and anneal results.

Total dose testing was performed using a Hopewell Designs N40 panoramic ^{60}Co irradiator. The irradiations were performed at 0.00875rad(Si)/s. A PbAl box was used to shield the test fixture and devices under test against low energy secondary gamma radiation.

The characterization matrix consisted of four samples irradiated under bias and four samples irradiated with all pins grounded. Four control units were used to ensure repeatable data. Two different wafers were used. The bias configuration is shown in [Figure 28](#).

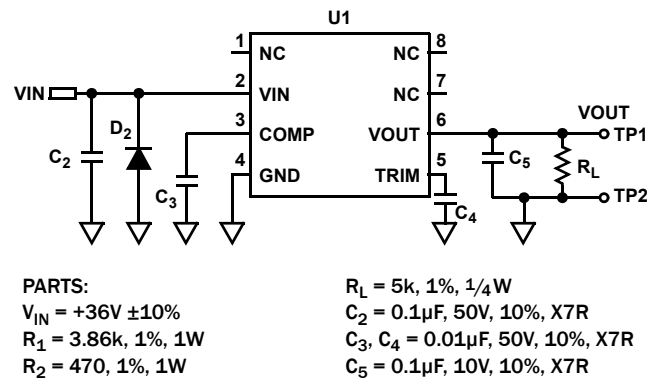

Figure 28. Irradiation Bias Configuration and Power Supply Sequencing for the ISL71010B50

All electrical testing was performed outside the irradiator using the production Automated Test Equipment (ATE), with data logging at each down point. Downpoint electrical testing was performed at room temperature.

5.1.2 Results

Table 2 summarizes the attributes data. “Bin 1” indicates a device that passes all datasheet specification limits.

Table 2. ISL71010B50 Total Dose Test Attributes Data

Dose Rate (mrad(Si)/s)	Bias	Sample Size	Down Point	Bin 1	Rejects
8.75	Figure 28	4	Pre-rad	4	0
			10krad(Si)	4	0
			30krad(Si)	4	0
8.75	Grounded	4	Pre-rad	4	0
			10krad(Si)	4	0
			30krad(Si)	4	0

The plots in Figures 29 through 34 show data for key parameters at all down points. The plots show the average as a function of total dose for each of the irradiation conditions. All parts showed excellent stability over irradiation.

Table 3 on page 16 shows the average of the key parameters with respect to total dose in tabular form.

5.1.3 Data Plots

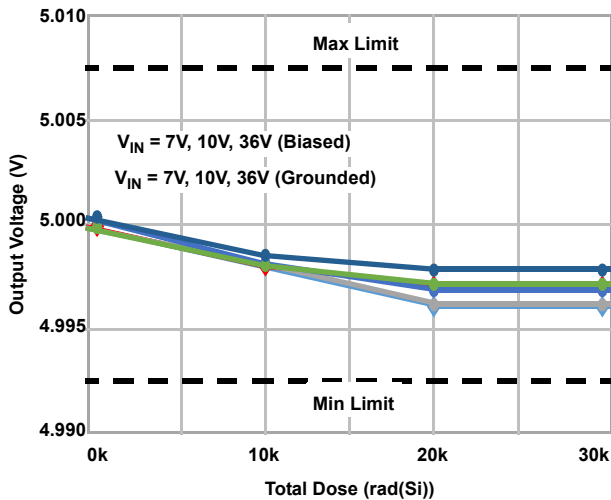

Figure 29. VREF Output Voltage vs TID

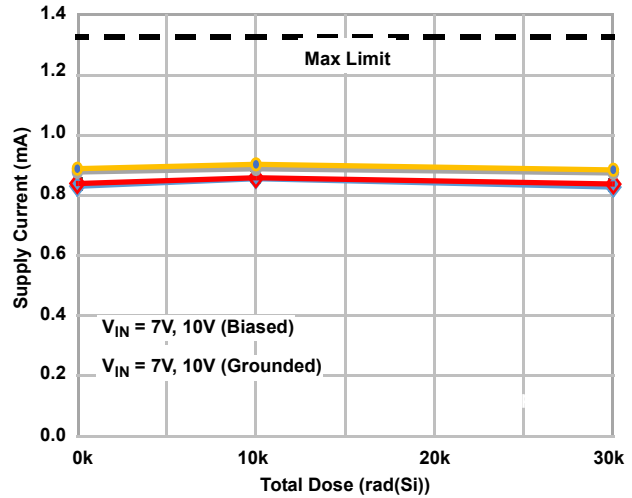

Figure 30. Supply Current vs TID

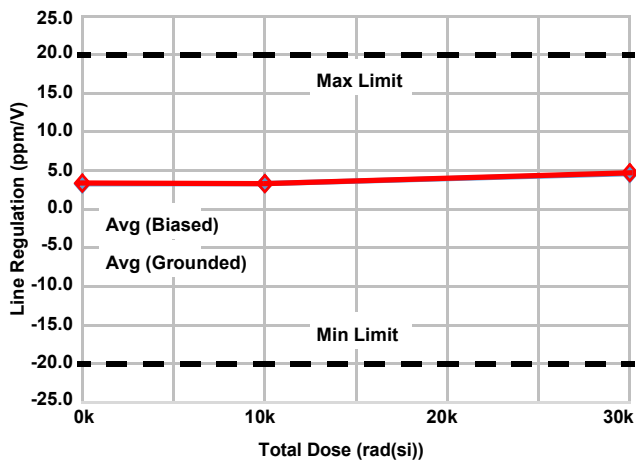

Figure 31. Line Regulation vs TID

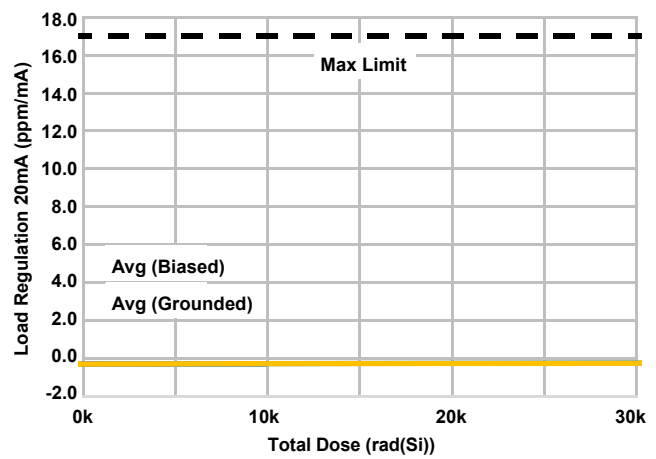

Figure 32. Load Regulation 20mA Sourcing vs TID

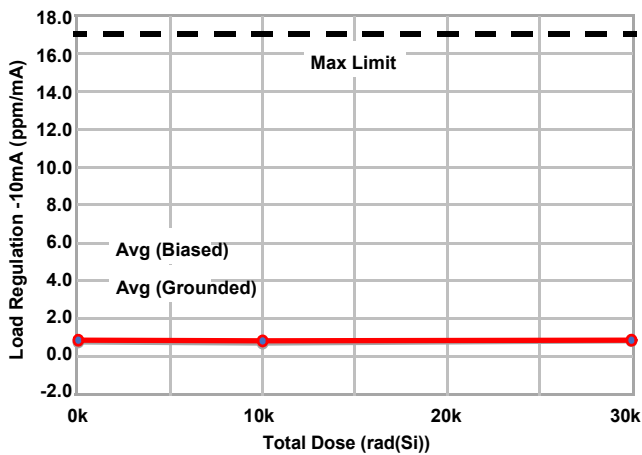

Figure 33. Load Regulation -10mA Sinking vs TID

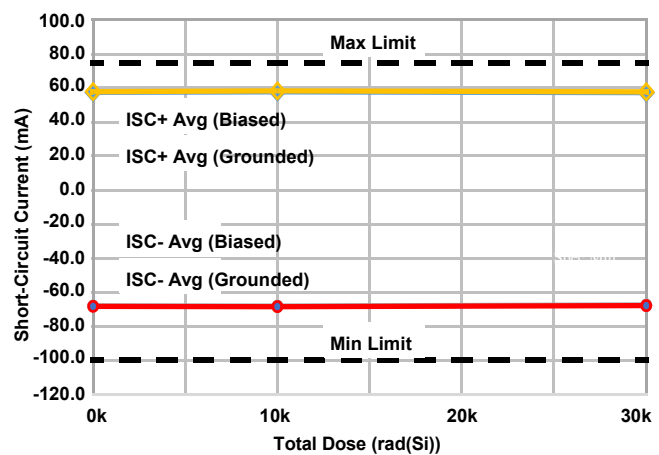

Figure 34. Short-Circuit Current vs TID

5.1.4 Conclusion

ATE characterization testing showed no rejects to the datasheet limits at all down points. Variables data for selected parameters is presented in [Figures 29](#) through [34](#). No differences between biased and unbiased irradiation were noted, and the part is not considered bias sensitive.

Table 3. ISL71010B50 Response of Key Parameters vs TID

Parameter	Symbol	Condition	Bias	0krad(Si)	10krad(Si)	30krad(Si)	Unit
Output Voltage	V_{OUT}	$V_{IN} = 10V$	Biased	4.999938	4.998027	4.996072	V
			Grounded	4.999922	4.998032	4.997056	
		$V_{IN} = 7V$	Biased	4.999885	4.998147	4.996166	
			Grounded	4.999873	4.998045	4.997138	
		$V_{IN} = 36V$	Biased	5.000362	4.998147	4.996840	
			Grounded	5.000366	4.998528	4.997825	
Supply Current	I_{IN}	$V_{CC} = 7V$	Biased	0.831391	0.0857090	0.829327	mA
			Grounded	0.840696	0.859878	0.839203	
		$V_{CC} = 10V$	Biased	0.879245	0.889788	0.876051	
			Grounded	0.889907	0.904760	0.886532	
Line Regulation	$\frac{\Delta V_{OUT}}{\Delta V_{IN}}$	$V_{IN} = 4V \text{ to } 30V, V_{OUT} = 2.5V$	Biased	3.295899	3.327616	4.641101	ppm/V
			Grounded	3.395929	3.326168	4.734789	
Load Regulation	$\frac{\Delta V_{OUT}}{\Delta I_{OUT}}$	20mA Sourcing	Biased	-0.271452	-0.273517	-0.222634	ppm/mA
			Grounded	-0.295225	-0.274575	-0.251689	
		-10mA Sinking	Biased	0.783360	0.720432	0.843916	
			Grounded	0.869870	0.840889	0.877108	
Short-Circuit Current	I_{SC+}	$V_{OUT} = GND$	Biased	57.370250	57.725323	57.320213	mA
			Grounded	57.804173	58.303010	57.731275	
	I_{SC-}	$V_{OUT} = V_{IN}$	Biased	-68.033388	-68.090658	-67.492365	
			Grounded	-68.297205	-68.480183	-67.858910	

5.2 Single Event Effects Testing

5.2.1 Introduction

The intense heavy ion environment encountered in space applications can cause a variety of Single-Event Effects (SEE). SEE can lead to system-level performance issues including disruption, degradation, and destruction. For predictable and reliable space system operation, individual electronic components should be characterized to determine their SEE response. The following is a summary of the ISL71010B50 SEE testing.

5.2.2 SEE Test Setup

Testing was performed at the Texas A&M University (TAMU) Cyclotron Institute heavy ion facility.

A schematic of the ISL71010B50 SEE test circuit is shown in [Figure 39 on page 19](#). The test circuit is configured to accept an input voltage from 7V to 30V and generate the 5.0V nominal output voltage. The output current of the reference was adjusted using fixed load resistors on a test board. The output capacitor, C_4 , and the compensation capacitor C_2 were 0.1 μ F and 10nF, respectively.

Digital multimeters were used to monitor input voltage (V_{IN}), output voltage (V_{OUT}), and input current (I_{IN}). A LeCroy waveRunner digital oscilloscope was used to monitor, capture, and store key signal waveforms. The scope was configured to trigger with V_{OUT} signal levels of $\pm 50mV$.

5.2.3 SEB Testing Results

For the SEB tests, conditions were selected to maximize the electrical and thermal stresses on the Device Under Test (DUT), thus insuring worst-case conditions. The input voltage (V_{IN}) was initially set to 35V and then increased in 1V increments. The capacitors were set to $C_{OUT} = 0.1\mu\text{F}$ and $C_{COMP} = 1\text{nF}$. SEB testing was conducted with the ISL71010B25. Output current (I_{OUT}) was set to 20mA which is the maximum recommended current rating for load regulation of the device. Case temperature was maintained at +125°C by controlling the current flowing into a resistor heater bonded to the underside of the DUT. Four DUTs were irradiated with Ag ions at a normal incident angle, resulting in an effective LET of 43MeV•cm²/mg.

The failure criterion for destructive SEE was an increase in operating input current (I_{IN}) greater than 5% measured at 20mA output current. I_{IN} is defined as the total current drawn by the device. Failed devices were not further irradiated.

From a design perspective, the ISL71010B25 and the ISL71010B50 are exactly the same in silicon. The output voltages, even though they are different values, are produced the same way and trimmed through a resistor ladder network. All the parts are built in the same process and are functionally equivalent. Therefore, the ISL71010B25 SEB results are applicable to the ISL71010B50.

Four parts passed irradiation to 1×10^7 ions/cm² with 43MeV•cm²/mg at 39V and +125°C case temperature.

5.2.4 Single Event Transient (SET) Testing

SET testing was done on four samples of the ISL71010B50, which were irradiated at room temperature at LETs of 2.7MeV•cm²/mg and 28MeV•cm²/mg to observe SET performance. Samples were separately tested to V_{IN} of 7V and 30V. The parts were configured with a 0.1μF output capacitor, 10nF compensation capacitor, and a 20mA load current to set up the worst conditions for negative going transients. [Table 4](#) shows the SET summary giving the cross section for each input voltage and LET level.

[Figures 35](#) through [38](#) represent output waveform responses of the DUTs at the respective bias conditions and LET levels. The plots are composites of all the transients captured on the scope.

The SET exhibited by the ISL71010B50 fall into two basic categories; fast negative spike and slow negative ramp. The fast spikes can be as large as 500mV for LET 28 and $V_{IN} = 30\text{V}$. Under the same conditions, the slow (20μs) negative ramp can reach 300mV. The slow ramp disturbances can take significantly over 160μs to recover. Even at LET = 8.5MeV•cm²/mg ([Figures 35 and 36](#)), there are SET of approximately 200mV.

Table 4. SET Summary of Fully Functional ISL71010B50

Supply Voltage (V)	LET (MeV•cm ² /mg)	Fluence (Particles/cm ²)	Events (±50mV)	Events CS (cm ²)
7	8.5	8.00E+06	375	4.69E-05
30	8.5	8.00E+06	442	5.53E-05
7	28	8.00E+06	743	9.29E-05
30	28	8.00E+06	1073	1.34E-04

Note: Samples at 7.0V and 30V input voltage. trigger level for the output voltage SET to ±50mV.

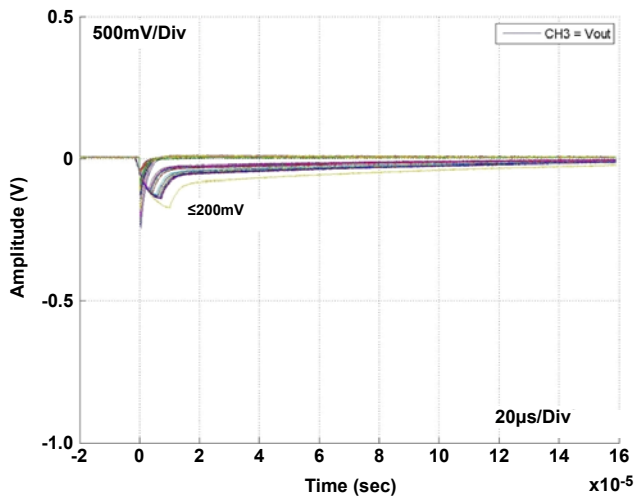

Figure 35. Composite SET Plot for ISL71010B50 at LET 8.5 $V_{IN} = 7V$, $I_{OUT} = 20mA$, $C_{OUT} = 0.1\mu F$, $C_{COMP} = 10nF$

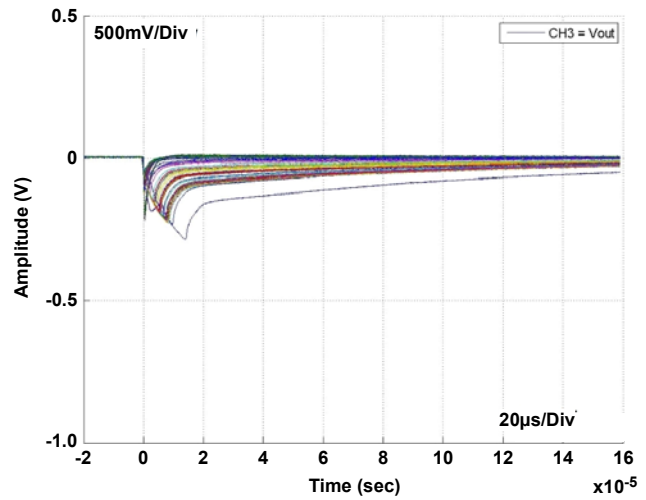

Figure 36. Composite SET Plot for ISL71010B50 at LET 8.5 $V_{IN} = 30V$, $I_{OUT} = 20mA$, $C_{OUT} = 0.1\mu F$, $C_{COMP} = 10nF$

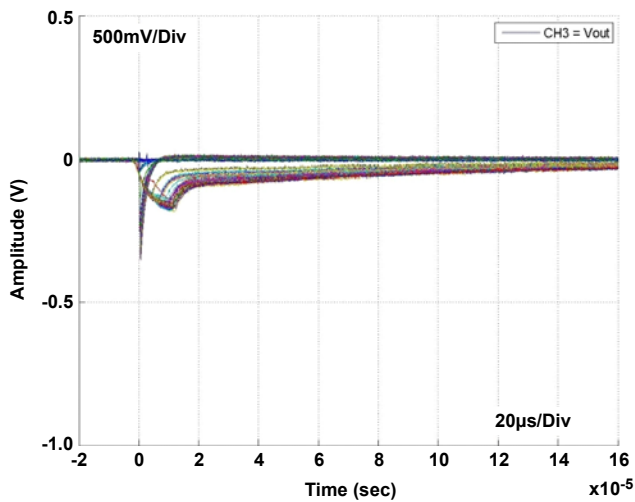

Figure 37. Composite SET Plot for ISL71010B50 at LET 28 $V_{IN} = 7V$, $I_{OUT} = 20mA$, $C_{OUT} = 0.1\mu F$, $C_{COMP} = 10nF$

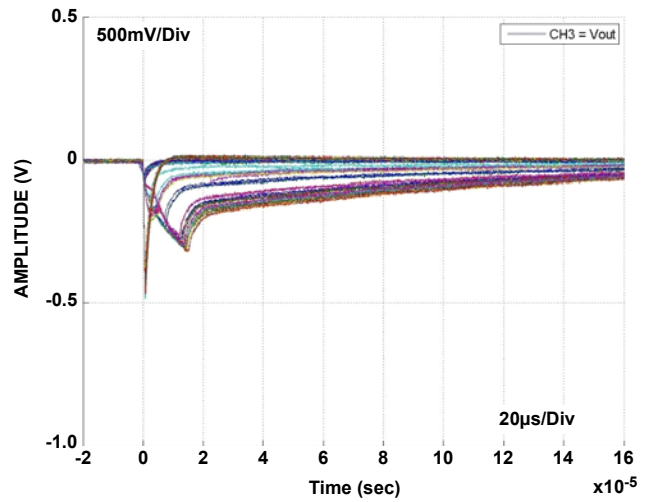

Figure 38. Composite SET Plot for ISL71010B50 at LET 28 $V_{IN} = 30V$, $I_{OUT} = 20mA$, $C_{OUT} = 0.1\mu F$, $C_{COMP} = 10nF$

6. Conclusion

SEE testing has demonstrated that the ISL71010B50 is not susceptible to Single Event Burnout (SEB) at an LET of $43\text{MeV}\cdot\text{cm}^2/\text{mg}$ with an input voltage of 39V and a load current of 20mA. This represents conditions that are over 30% above the recommended input voltage of 30V and 100% of the load regulation drive capability of the IC (20mA).

SET testing demonstrated that all transients are negative and the higher the LET level the greater the magnitude of the negative transient. At $\text{LET} = 28\text{MeV}\cdot\text{cm}^2/\text{mg}$ and $V_{\text{IN}} = 30\text{V}$ with $C_{\text{OUT}} = 0.10\mu\text{F}$, showed a 500mV fast negative transient and a 300mV slow (20us) negative transient during an SET event. The slow transient can take over 160 μs to recovery. At $\text{LET} = 8.5\text{MeV}\cdot\text{cm}^2/\text{mg}$ there are SET of approximately 200mV.

A larger C_{OUT} capacitance value will suppress the SET magnitude but the SET disturbance duration will stretch out. Capacitor selection represents a compromise between SET magnitude and recovery duration.

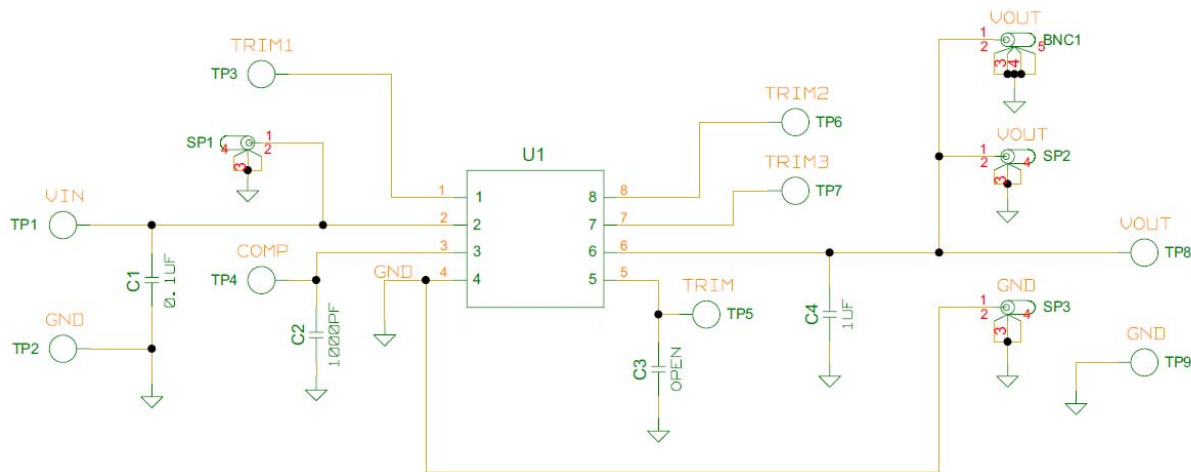

Figure 39. SEE Testing Schematic for the ISL71010B50

7. Revision History

Rev.	Date	Description
1.00	Apr 12, 2018	Added Outgassing Feature bullet. Updated Ordering information by adding -TK part to table and updated Note 1. Added Outgassing specification information. Removed About Intersil and updated disclaimer.
0.00	Sep 29, 2017	Initial release

8. Package Outline Drawing

For the most recent package outline drawing, see [M8.15](#).

M8.15
 8 LEAD NARROW BODY SMALL OUTLINE PLASTIC PACKAGE
 Rev 4, 1/12

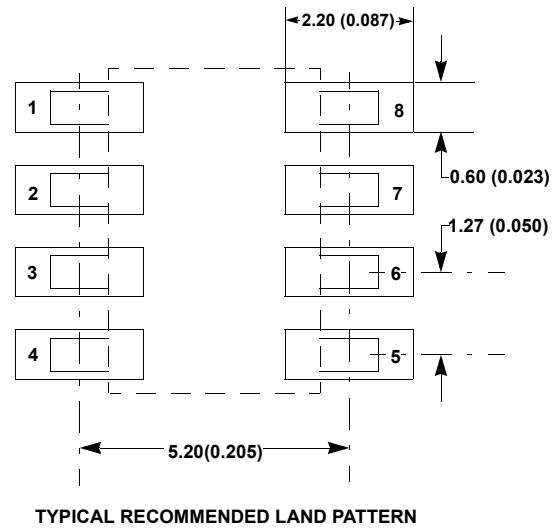
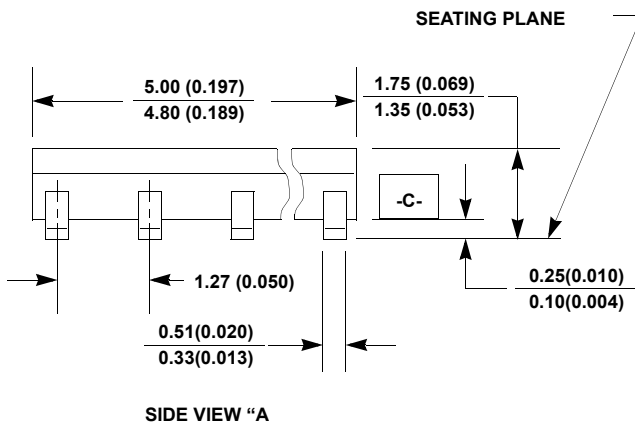
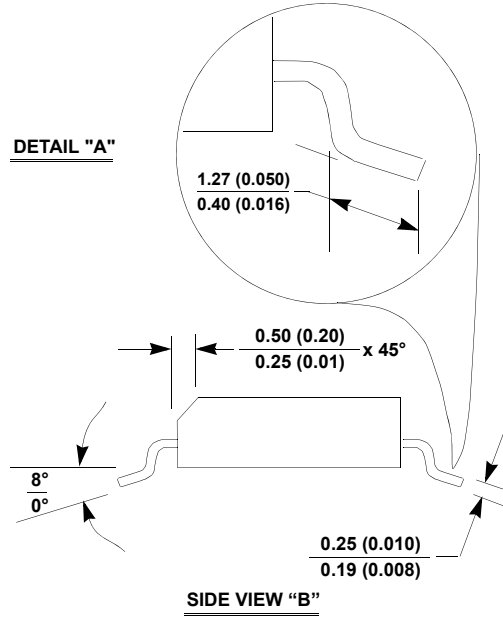
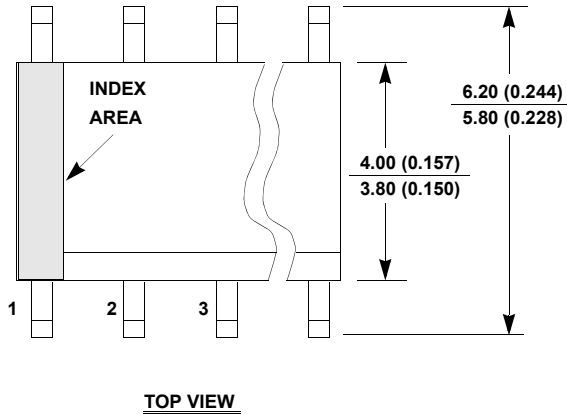

NOTES:

1. Dimensioning and tolerancing per ANSI Y14.5M-1994.
2. Package length does not include mold flash, protrusions or gate burrs. Mold flash, protrusion and gate burrs shall not exceed 0.15mm (0.006 inch) per side.
3. Package width does not include interlead flash or protrusions. Interlead flash and protrusions shall not exceed 0.25mm (0.010 inch) per side.
4. The chamfer on the body is optional. If it is not present, a visual index feature must be located within the crosshatched area.
5. Terminal numbers are shown for reference only.
6. The lead width as measured 0.36mm (0.014 inch) or greater above the seating plane, shall not exceed a maximum value of 0.61mm (0.024 inch).
7. Controlling dimension: MILLIMETER. Converted inch dimensions are not necessarily exact.
8. This outline conforms to JEDEC publication MS-012-AA ISSUE C.

IMPORTANT NOTICE AND DISCLAIMER

RENESAS ELECTRONICS CORPORATION AND ITS SUBSIDIARIES (“RENESAS”) PROVIDES TECHNICAL SPECIFICATIONS AND RELIABILITY DATA (INCLUDING DATASHEETS), DESIGN RESOURCES (INCLUDING REFERENCE DESIGNS), APPLICATION OR OTHER DESIGN ADVICE, WEB TOOLS, SAFETY INFORMATION, AND OTHER RESOURCES “AS IS” AND WITH ALL FAULTS, AND DISCLAIMS ALL WARRANTIES, EXPRESS OR IMPLIED, INCLUDING, WITHOUT LIMITATION, ANY IMPLIED WARRANTIES OF MERCHANTABILITY, FITNESS FOR A PARTICULAR PURPOSE, OR NON-INFRINGEMENT OF THIRD PARTY INTELLECTUAL PROPERTY RIGHTS.

These resources are intended for developers skilled in the art designing with Renesas products. You are solely responsible for (1) selecting the appropriate products for your application, (2) designing, validating, and testing your application, and (3) ensuring your application meets applicable standards, and any other safety, security, or other requirements. These resources are subject to change without notice. Renesas grants you permission to use these resources only for development of an application that uses Renesas products. Other reproduction or use of these resources is strictly prohibited. No license is granted to any other Renesas intellectual property or to any third party intellectual property. Renesas disclaims responsibility for, and you will fully indemnify Renesas and its representatives against, any claims, damages, costs, losses, or liabilities arising out of your use of these resources. Renesas' products are provided only subject to Renesas' Terms and Conditions of Sale or other applicable terms agreed to in writing. No use of any Renesas resources expands or otherwise alters any applicable warranties or warranty disclaimers for these products.

(Rev.1.0 Mar 2020)

Corporate Headquarters

TOYOSU FORESIA, 3-2-24 Toyosu,
Koto-ku, Tokyo 135-0061, Japan
www.renesas.com

Contact Information

For further information on a product, technology, the most up-to-date version of a document, or your nearest sales office, please visit:
www.renesas.com/contact/

Trademarks

Renesas and the Renesas logo are trademarks of Renesas Electronics Corporation. All trademarks and registered trademarks are the property of their respective owners.

Компания «Океан Электроники» предлагает заключение долгосрочных отношений при поставках импортных электронных компонентов на взаимовыгодных условиях!

Наши преимущества:

- Поставка оригинальных импортных электронных компонентов напрямую с производств Америки, Европы и Азии, а так же с крупнейших складов мира;
- Широкая линейка поставок активных и пассивных импортных электронных компонентов (более 30 млн. наименований);
- Поставка сложных, дефицитных, либо снятых с производства позиций;
- Оперативные сроки поставки под заказ (от 5 рабочих дней);
- Экспресс доставка в любую точку России;
- Помощь Конструкторского Отдела и консультации квалифицированных инженеров;
- Техническая поддержка проекта, помощь в подборе аналогов, поставка прототипов;
- Поставка электронных компонентов под контролем ВП;
- Система менеджмента качества сертифицирована по Международному стандарту ISO 9001;
- При необходимости вся продукция военного и аэрокосмического назначения проходит испытания и сертификацию в лаборатории (по согласованию с заказчиком);
- Поставка специализированных компонентов военного и аэрокосмического уровня качества (Xilinx, Altera, Analog Devices, Intersil, Interpoint, Microsemi, Actel, Aeroflex, Peregrine, VPT, Syfer, Eurofarad, Texas Instruments, MS Kennedy, Miteq, Cobham, E2V, MA-COM, Hittite, Mini-Circuits, General Dynamics и др.);

Компания «Океан Электроники» является официальным дистрибьютором и эксклюзивным представителем в России одного из крупнейших производителей разъемов военного и аэрокосмического назначения «JONHON», а так же официальным дистрибьютором и эксклюзивным представителем в России производителя высокотехнологичных и надежных решений для передачи СВЧ сигналов «FORSTAR».



JONHON

«JONHON» (основан в 1970 г.)

Разъемы специального, военного и аэрокосмического назначения:

(Применяются в военной, авиационной, аэрокосмической, морской, железнодорожной, горно- и нефтедобывающей отраслях промышленности)

«FORSTAR» (основан в 1998 г.)

ВЧ соединители, коаксиальные кабели, кабельные сборки и микроволновые компоненты:

(Применяются в телекоммуникациях гражданского и специального назначения, в средствах связи, РЛС, а так же военной, авиационной и аэрокосмической отраслях промышленности).



Телефон: 8 (812) 309-75-97 (многоканальный)

Факс: 8 (812) 320-03-32

Электронная почта: ocean@oceanchips.ru

Web: <http://oceanchips.ru/>

Адрес: 198099, г. Санкт-Петербург, ул. Калинина, д. 2, корп. 4, лит. А