



MULTILAYER CERAMIC DIPPED AXIAL AND RADIAL CAPACITORS
for Automotive Applications



Multilayer Ceramic Dipped Axial and Radial
Capacitors for Automotive Applications



Capacitors - AEC-Q200 Approved

TABLE OF CONTENTS

- Applications..... 2
- General Information 3
- Ordering Information 4
- Electrical Data and Dielectric Characteristics 5
- Dimensions Data 6
- Marking..... 7
 - Mono-Axial Marking Code Description 7
 - Mono-Kap 8
- Packaging..... 9
 - Mono-Axial 9
 - Mono-Kap 11
- Product Range 13
 - Mono-Axial C0G Dielectric..... 13
 - Mono-Axial X7R Dielectric 14
 - Mono-Axial X8R Dielectric 16
 - Mono-Kap C0G Dielectric 17
 - Mono-Kap X7R Dielectric..... 18
 - Mono-Axial X8R Dielectric 20

One of the World's Largest Manufacturers of
Discrete Semiconductors and Passive Components





MULTILAYER CERAMIC DIPPED AXIAL AND RADIAL CAPACITORS

for Automotive Applications



Applications



Capacitors - AEC-Q200 Approved

Powertrain

- Engine Control Unit
- Common Rail Diesel Electrical Control
- Turbo Charger Control Unit
- Piezoelectric-Injection Driver
- Engine Sensors
- Electrical Fan Control
- Electrical Water Pump
- Ignition Electrical Drive
- Board Load-Control Unit
- Integrated Starter Generator
- Boardnet Management

Lighting Systems

- Headlight Leveling Control and Advanced Front Lighting Cleaning System
- Sensors for Night Vision Systems and Fog Detection
- LED Lighting
- Ambient Lighting
- HID Electrical

Chassis

- Active Safety
- Sensors
- EAGA, Electrical Catalytic Converter, Diesel Particle Filter
- Electrical Transmission
- Electric Park Brake
- Active Suspension
- Electrical Power Steering
- Electrical Hydraulic Power Steering
- Tire Pressure Monitoring

Body and Comfort

- Sensors
- Climate Control
- Seat Adjust and Memory
- Immobilizer and Security Systems
- Dashboard and Interior Illumination
- HVAC—Heating, Ventilating, Air Conditioning
- Multimedia Systems
- Passive Safety
- Reversible Wiper Drives
- Keyless or Passive Entry
- Door / Window / Sunroof Control

Driver Information

- Driver Information System
- GPS Car Navigation and Audio System
- SDARS / Antenna / Amplifier System
- Bluetooth Communication
- Lidar Sensor



MULTILAYER CERAMIC DIPPED AXIAL AND RADIAL CAPACITORS for Automotive Applications



General Information

For more than 20 years, Vishay Vitramon has supported the automotive industry with robust, highly reliable MLCCs that have made it a leader in this segment. All Vishay Vitramon MLCCs are manufactured in precious metal technology (PMT/NME) with a wet build process. They are qualified according to AEC-Q200 with PPAP available on request.

These chips are used in the automotive-grade Mono-Axial and Mono-Kap series from Vishay BCcomponents. They feature coppery steel wire lead terminations with a 100 % tin plate matte finish. Their epoxy coating provides mechanical strength for assembly extended-life environmental protection.



RoHS COMPLIANT



Capacitors - AEC-Q200 Approved

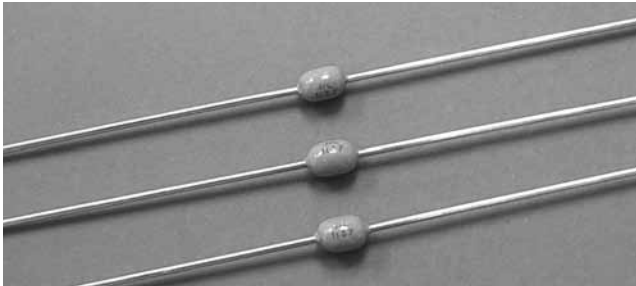
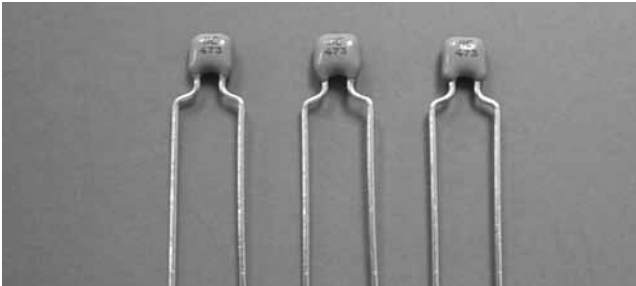

Table with 2 columns: C0G (NP0) Dielectric and X7R, X8R Dielectric. Rows include Note, Operating Temperature, Capacitance Range, Temperature Coefficient of Capacitance (TCC), Dissipation Factor (DF), Voltage Range, Insulating Resistance, Aging, and Dielectric Withstanding Voltage (DWV).



MULTILAYER CERAMIC DIPPED AXIAL AND RADIAL CAPACITORS for Automotive Applications



Ordering Information

Mono-Axial

A	103	K	15	X7R	F	5	TAA	V
Product Type	Capacitance Code	Cap. Tolerance	Size Code	Temp. Char.	Rated Voltage	Lead Dia.	Packaging	Automotive Application
A = Mono-Axial	Two significant digits followed by the number of zeros. Example: 103 = 10 000 pF	J = ± 5 % K = ± 10 % M = ± 20 %	Ref. mechanical spec.	C0G X7R X8R	F = 50 V H = 100 V K = 200 V	5 = 0.5 mm (0.20")	TAA = T&R UAA = AMMO	AEC Q200 Qualified for Automotive Grade Product

Ordering Example: A-103-K-15-X7R-F-5-TAA-V

Mono-Kap

K	102	K	15	X7R	F	5	3	H	5	V
Product Type	Capacitance Code	Cap. Tolerance	Size Code	Temp. Char.	Rated Voltage	Lead Dia.	Packaging	Lead Style	Lead Spacing	Automotive Application
A = Mono-Kap	Two significant digits followed by the number of zeros. Example: 102 = 1000 pF	J = ± 5 % K = ± 10 % M = ± 20 %	Ref. mechanical spec.	C0G X7R X8R	F = 50 V H = 100 V K = 200 V	5 = 0.5 mm (0.20")	3 = BULK, with lead length of 30 ± 5.0 mm (1.25") T = Tape and reel U = AMMO	L = Straight lead H = Hight seated assy	2 = 2.5 mm (0.1") 5 = 5.0 mm (0.2")	AEC Q200 Qualified for Automotive Grade Product

Ordering Example: K-473-K-15-X7R-F-5-3-H-5-V

Capacitors - AEC-Q200 Approved



Electrical Data and Dielectric Characteristics

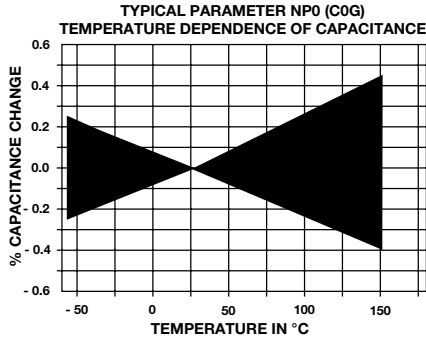

Remark: NP0 and X7R are defined temperature up to + 125 °C

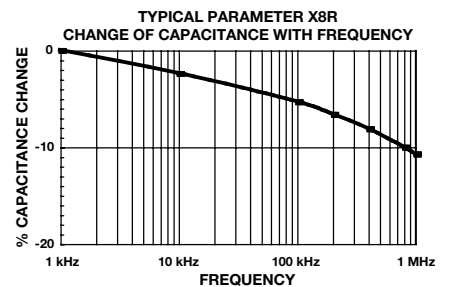
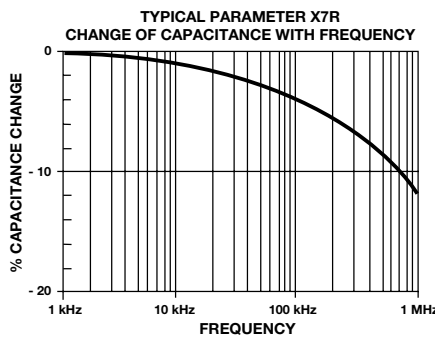
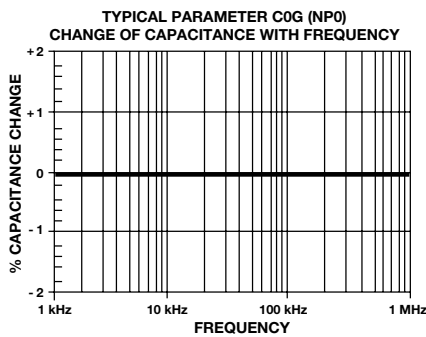
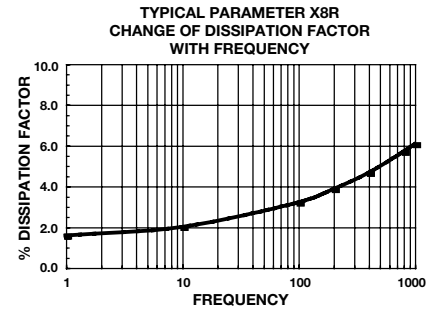
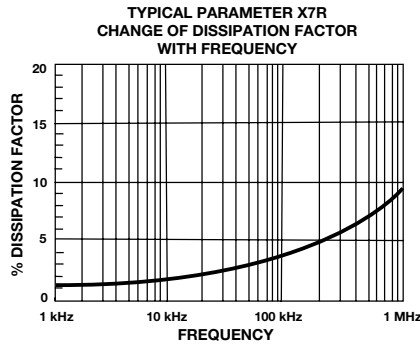
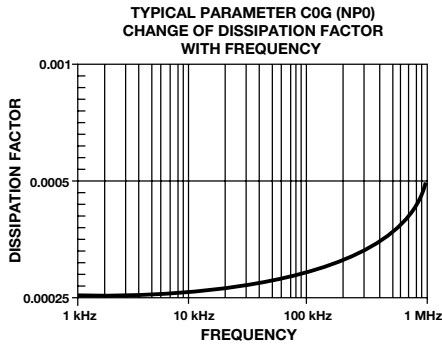

Capacitors - AEC-Q200 Approved

Dimensions Data

Mono-Axial

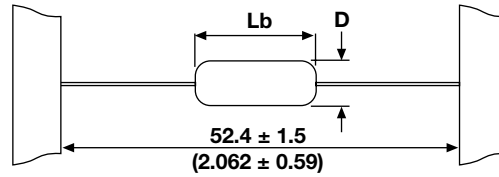

Capacitor Dimensions and Weight				
Size Code	$Lb_{max}^{(1)}$	$\varnothing D_{max}^{(1)}$	Lead diameter (mm)	Weight (g)
15	0.15 (3.8)	0.10 (2.5)	0.5 ± 0.05	≈ 0.14
20	0.20 (5.0)	0.12 (3.0)	0.5 ± 0.05	≈ 0.15

Note: 1. Dimensions between parentheses are in millimeters.
 2. If inserted with 1210 chip, then $\varnothing d_{max}$ is 4.5 mm (0.18").

Mono-Kap

L2
 Component outline for
 Lead spacing 2.5 ± 0.8 mm
 (straight leads)

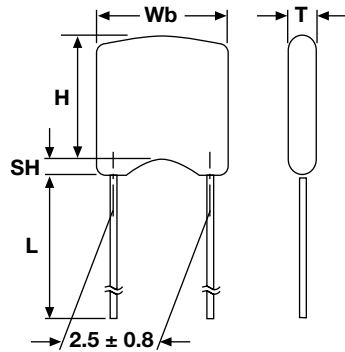

H5
 Component outline for
 Lead spacing 5.0 ± 0.8 mm
 (flat bent leads)

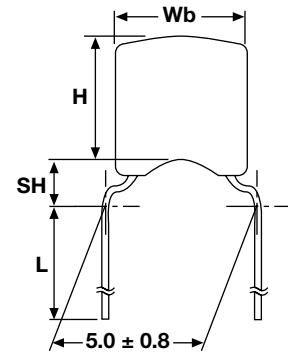

L2 and H5 are preferred styles

K2
 Component outline for
 Lead spacing 2.5 ± 0.8 mm
 (outside kink)

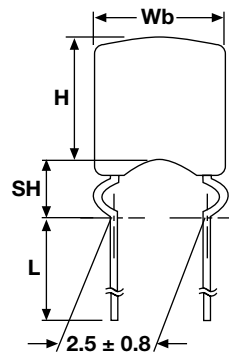

K5
 Component outline for
 Lead spacing 2.5 ± 0.8 mm
 (outside kink)

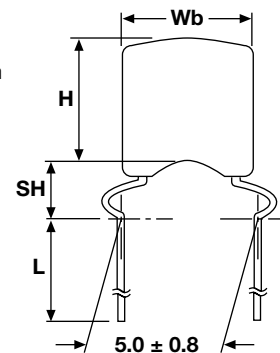

CAPACITOR DIMENSIONS (Unit: mm)

SIZE CODE	Wb	H	T	Lead Diameter	MAX. SEATING HEIGHT (SH)			
					L2	H5	K2	K5
15	3.0-3.8	2.0-3.8	1.6-2.6	0.5 ± 0.05	1.6	2.6	3.5	3.5
20	4.3-5.1	2.5-5.1	1.9-3.2	0.5 ± 0.05	1.6	2.6	3.5	3.5



MULTILAYER CERAMIC DIPPED AXIAL AND RADIAL CAPACITORS
for Automotive Applications



Marking

Mono-Axial Marking Code Description

DDD Date Code	XXX Capacitance Code	t Tolerance Code	V Voltage Code	T T.C. Code
The first digit is the year, the last two digits are the week Examples: 309 = 2003, 9th week 317 = 2003, 17th week	Two significant digits followed by one digit for the multiplier as given below. 0=x 1 2=x 100 4=x 10 000 1=x 10 3=x 1000 5=x 100 000	J = ± 5 % K = ± 10 % M = ± 20 %	1 = 100 V 2 = 200 V 5 = 50 V	A = C0G(NP0) C = X7R R = X8R

Capacitors - AEC-Q200 Approved

Capacitance Value < 100 pF



Capacitance Value ≥ 100 pF

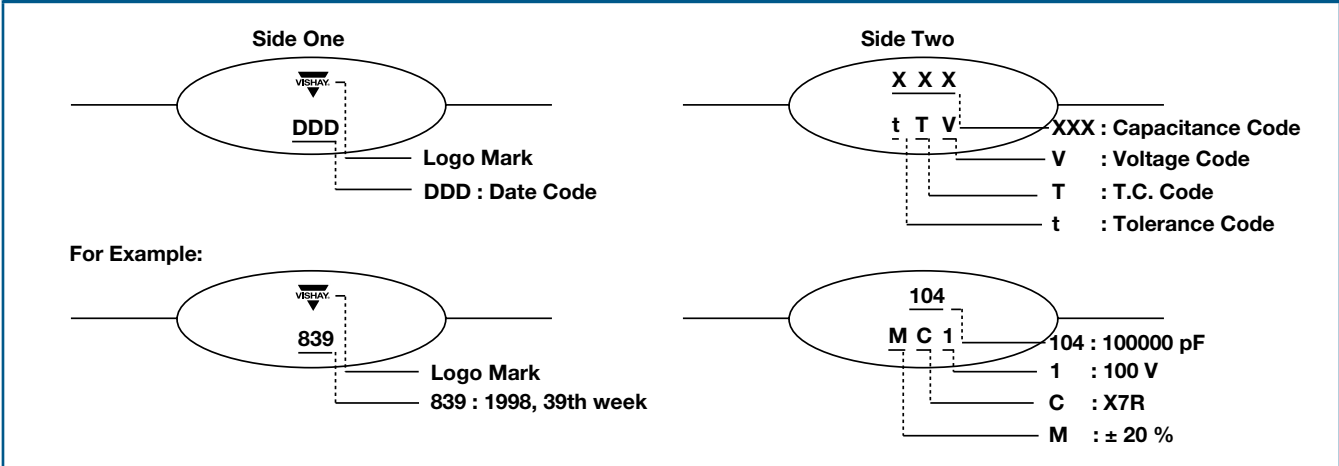

Note: VISHAY or BCcomponents logo can be marked on the products body.



MULTILAYER CERAMIC DIPPED AXIAL AND RADIAL CAPACITORS for Automotive Applications



Capacitors - AEC-Q200 Approved

Marking

Mono-Kap

Size 15 Capacitance Value < 100 pF

Vishay logo or BC logo

t : Tolerance code

XX : Capacitance code

For example

Vishay logo or BC logo

J : ± 5 %

82 : 82 pF

Size 15 Capacitance Value ≥ 100 pF

Vishay logo or BC logo

XXX : Capacitance code

For example

Vishay logo or BC logo

102 : 1000 pF

Size 20 Capacitance Value ≥ 100 pF

Vishay logo or BC logo

t : Tolerance code

XXX : Capacitance code

For example

Vishay logo or BC logo

M : ± 20 %

104 : 100000 pF



MULTILAYER CERAMIC DIPPED AXIAL AND RADIAL CAPACITORS
for Automotive Applications



Capacitors - AEC-Q200 Approved

Packaging

Mono-Axial

Reel Data

- A maximum of 0.5 % of the total number of capacitors per reel may be missing.
- A maximum of 1 consecutive vacant positions is followed by 6 consecutive components.
- Tape begins and ends with a minimum of 4 empty positions (50 mm tape).
- Maximum of 5 splicers per reel.

Ammopack Data

- A maximum of 0.5 % of the total number of capacitors per reel may be missing.
- A maximum of 1 consecutive vacant positions is followed by 6 consecutive components.
- Tape begins and ends with a minimum of 4 empty positions (180 mm tape).
- Maximum of 5 splicers per reel.
- The cumulative pitch tolerance over 20 consecutive units is not to exceed ± 1.0 mm.
- Lead space (F) shall be measured at (3.6 ± 0.5) mm from the capacitor seating plane.

Labelling

- Each reel is provided with a label showing the following details:
- Manufacturer, A style, capacitance, tolerance, batch number, quantity of components, rated voltage, dielectric.
- On special request other designations can be shown.
- See example.

Reel and Reel Dimensions

REEL SIZE		(mm)
A	Outer Dia.	355.6 Max
L	Hole Dia.	28 ± 1.5
K	Core Dia.	90
H ₁	Internal Width	69.9 ± 1.5

Ammopack

Labelling Example

>>



Packaging

Mono-Axial (continued)

Packaging Quantities and Box Dimensions

Packaging	Size Code	Smallest Packaging Quantity (SPQ)	Box Dimensions L x W x H (mm)
Tape on reel	15; 20	7000	370 x 370 x 90
Ammopack	15; 20	4000	265 x 85 x 95

Capacitors on Bandolier

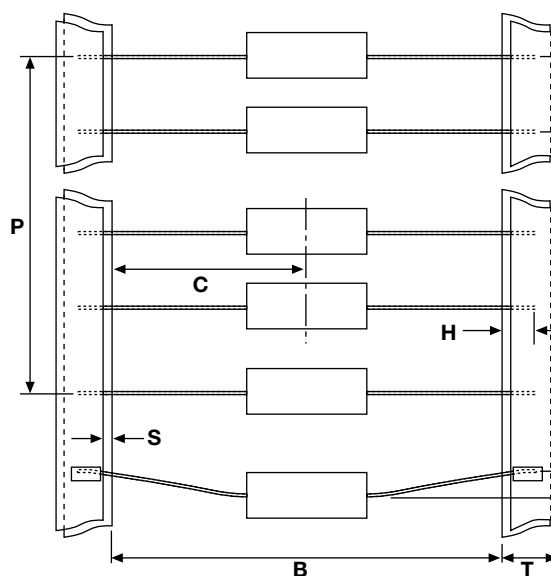

Symbol	Parameter	Dimensions	
		mm	inch
B ⁽¹⁾	Inside tape spacing	52.4 ± 1.5	2.062 ± 0.059
C	Centre to tape spacing	± 0.8	± 0.031
P	Cumulative pitch, 6 consecutive components	± 1.5	± 0.059
A	Components pitch	5 ± 0.5	0.197 ± 0.015
M	Lead bend	< 1.2	< 0.047
S	Exposed adhesive	< 0.51	> 0.020
T	Tape width	6.35	0.25
H	Lead sandwich	> 3.96	> 0.156

Note:

1. Inside tape spacing 26.0 + 1.51/- 0.0 is available on request

Capacitors - AEC-Q200 Approved



MULTILAYER CERAMIC DIPPED AXIAL AND RADIAL CAPACITORS

for Automotive Applications



Capacitors - AEC-Q200 Approved

Packaging

Mono-Kap

Reel Data

- A maximum of 0.5 % of the total number of capacitors per reel may be missing.
- A maximum of 1 consecutive vacant positions is followed by 6 consecutive components.
- Tape begins and ends with a minimum of 4 empty positions (50 mm tape).
- Maximum of 5 splicers per reel.

Ammopack Data

- A maximum of 0.5 % of the total number of capacitors per reel may be missing.
- A maximum of 1 consecutive vacant positions is followed by 6 consecutive components.
- Tape begins and ends with a minimum of 4 empty positions (50 mm tape).
- Maximum of 5 splicers per reel.
- The cumulative pitch tolerance over 20 consecutive units is not to exceed ± 1.0 mm.
- Lead space (F) shall be measured at (3.6 ± 0.5) mm from the capacitor seating plane.

Labelling

- Each reel is provided with a label showing the following details:
- Manufacturer, K style, capacitance, tolerance, batch number, quantity of components, rated voltage, dielectric.
- On special request other designations can be shown.
- See example.

Labelling Example



Reel and Reel Dimensions

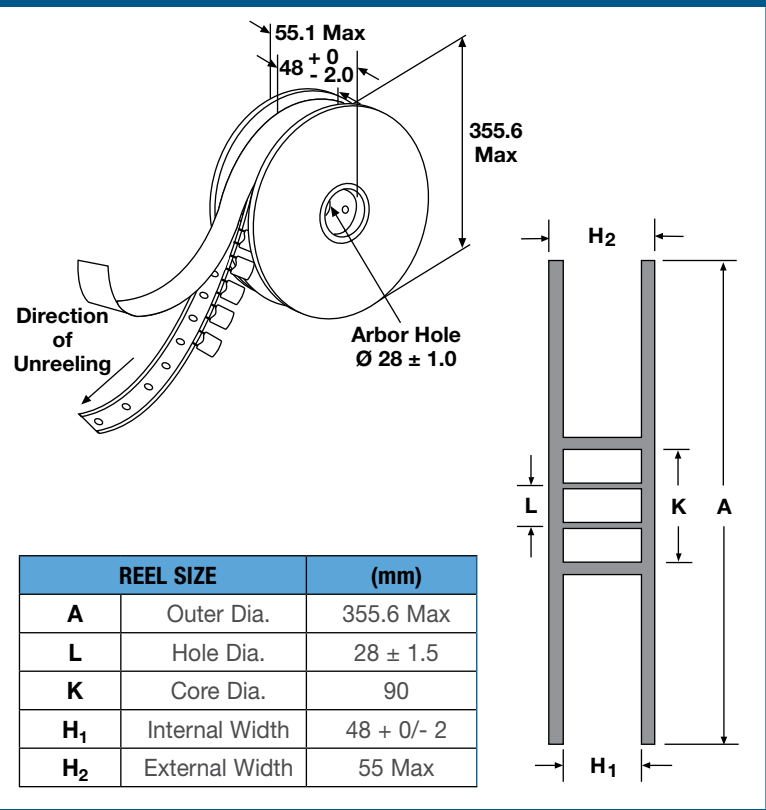

Ammopack

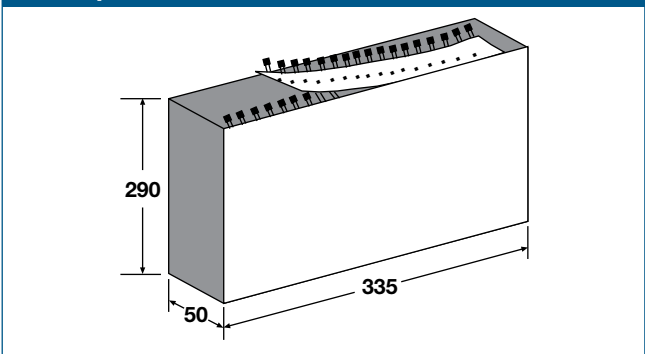

Packaging Quantities and Box Dimensions

Packaging	Size Code	Smallest Packaging Quantity (SPQ)	Box Dimensions L x W x H (mm)
Tape on reel	15	4000	370 x 370 x 60
	20	3000	
Ammopack	15; 20	2500	335 x 290 x 50
Bulk (Note 1)	15; 20	5000	245 x 120 x 65

Note:
1. SPQ contains one or a multiple of poly-bags, 1000 units per bag.

Packaging

Mono-Kap (continued)

Capacitors on Tape



Symbol	Parameter	Dimensions	
		mm	inch
L	Cut of length	≤ 11	≤ 0.443
L ₁	Lead end protrusion	≤ 1	≤ 0.039
H	Height to seating plane (straight leads)	≥ 18	≥ 0.709
H ₀	Height to seating plane (crimp leads)	16.0 ± 0.5	0.630 ± 0.020
H ₁	Top of Component height	≤ 32	≤ 1.26
Δh	Body inclination	0.0 ± 1.0	0 ± 0.039
W	Carrier tape width	18.0 + 1.0/- 0.5	0.709 + 0.039/- 0.02
W ₀	Hold down tape width	15.0 ref. (Note 2)	0.591 ref. (Note 2)
W ₁	Sprocket hole position	9 + 0.075/- 0.5	0.354 + 0.03/- 0.02
F	1e lead space (Note 3)	2.5 + 0.60/- 0.40	0.10 + 0.024/- 0.016
	2e lead space (Note 3)	5.0 + 0.60/- 0.40	0.20 + 0.024/- 0.016
P ₀	Sprocket hole pitch	12.7 ± 0.3	0.50 ± 0.012
P ₁	1e sprocket hole centre to lead centre	5.08 ± 0.7	0.20 ± 0.028
	2e sprocket hole centre to lead centre	3.85 ± 0.7	0.015 ± 0.028
D ₀	Sprocket hole diameter	4.0 ± 0.30	0.157 ± 0.012
t	Overall tape thickness	≤ 0.9	≤ 0.035
d	Wire lead diameter	0.50 ± 0.05	0.02 ± 0.002
P	Taping pitch	12.7 ref.	0.50 ref.

Note:

2. Tape width of 6 mm (0.236 inch) permissible.

3. e = 2.54 mm.



MULTILAYER CERAMIC DIPPED AXIAL AND RADIAL CAPACITORS

for Automotive Applications



Product Range

Mono-Axial C0G Dielectric

C	Tol. (%)	Lb Max (mm)	ØD Max (mm)	Clear Text Code without Lead configuration and Packaging ⁽¹⁾		
50 Vdc						
100 pF	5	3.81	2.54	A101J15C0GF□□□□V		
150 pF				A151J15C0GF□□□□V		
220 pF				A221J15C0GF□□□□V		
330 pF				A331J15C0GF□□□□V		
470 pF				A471J15C0GF□□□□V		
680 pF				A681J15C0GF□□□□V		
1000 pF				A102J15C0GF□□□□V		
1500 pF				A152J15C0GF□□□□V		
2200 pF				A222J15C0GF□□□□V		
3300 pF				A332J15C0GF□□□□V		
3900 pF				A392J15C0GF□□□□V		
4700 pF	5	5.08	3.05	A472J20C0GF□□□□V		
6800 pF				A682J20C0GF□□□□V		
0.01 µF				A103J20C0GF□□□□V		
100 Vdc						
100 pF	5	3.81	3.81	A101J15C0GH□□□□V		
150 pF				A151J15C0GH□□□□V		
220 pF				A221J15C0GH□□□□V		
330 pF				A331J15C0GH□□□□V		
470 pF				A471J15C0GH□□□□V		
680 pF				A681J15C0GH□□□□V		
1000 pF				A102J15C0GH□□□□V		
1500 pF		A152J15C0GH□□□□V				
1800 pF		A182J15C0GH□□□□V				
2200 pF		5.08	3.05	A222J20C0GH□□□□V		
3300 pF				A332J20C0GH□□□□V		
4700 pF				A472J20C0GH□□□□V		
6800 pF				A682J20C0GH□□□□V		
0.01 µF				A103J20C0GH□□□□V		
200 Vdc						
100 pF	5			3.81	2.54	A101J15C0GK□□□□V
150 pF		A151J15C0GK□□□□V				
220 pF		A221J15C0GK□□□□V				
330 pF		A331J15C0GK□□□□V				
470 pF		A471J15C0GK□□□□V				
680 pF		A681J15C0GK□□□□V				
1000 pF		A102J15C0GK□□□□V				

Note:

1. The four blank digits are filled with lead configuration and packaging, and please refer to ordering information

MULTILAYER CERAMIC DIPPED AXIAL AND RADIAL CAPACITORS
for Automotive Applications

Product Range
Mono-Axial X7R Dielectric

C	Tol. (%)	Lb Max (mm)	ØD Max (mm)	Clear Text Code without Lead configuration and Packaging ⁽¹⁾
50 Vdc				
470 pF	10	3.81	2.54	A471K15X7RF□□□□V
680 pF				A681K15X7RF□□□□V
1000 pF				A102K15X7RF□□□□V
1500 pF				A152K15X7RF□□□□V
2200 pF				A222K15X7RF□□□□V
3300 pF				A332K15X7RF□□□□V
4700 pF				A472K15X7RF□□□□V
6800 pF				A682K15X7RF□□□□V
0.010 µF				A103K15X7RF□□□□V
0.015 µF				A153K15X7RF□□□□V
0.022 µF				A223K15X7RF□□□□V
0.033 µF				A333K15X7RF□□□□V
0.047 µF				A473K15X7RF□□□□V
0.068 µF				A683K15X7RF□□□□V
0.10 µF				A104K15X7RF□□□□V
0.15 µF				A154K15X7RF□□□□V
0.22 µF	10	5.08	3.05	A224K20X7RF□□□□V
0.33 µF				A334K20X7RF□□□□V
0.47 µF				A474K20X7RF□□□□V
0.68 µF		5.08	4.5 ⁽²⁾	A684K20X7RF□□□□V
1.0 µF		A105K20X7RF□□□□V		
100 Vdc				
470 pF	10	3.81	3.81	A471K15X7RH□□□□V
680 pF				A681K15X7RH□□□□V
1000 pF				A102K15X7RH□□□□V
1500 pF				A152K15X7RH□□□□V
2200 pF				A222K15X7RH□□□□V
3300 pF				A332K15X7RH□□□□V
4700 pF				A472K15X7RH□□□□V
6800 pF				A682K15X7RH□□□□V
0.010 µF				A103K15X7RH□□□□V
0.015 µF				A153K15X7RH□□□□V
0.022 µF				A223K15X7RH□□□□V
0.033 µF				A333K15X7RH□□□□V
0.047 µF				A473K15X7RH□□□□V
0.068 µF				A683K15X7RH□□□□V
0.10 µF				A104K15X7RH□□□□V

Note:

1. The four blank digits are filled with lead configuration and packaging, and please refer to ordering information
2. Inserted with 1210 chip





MULTILAYER CERAMIC DIPPED AXIAL AND RADIAL CAPACITORS

for Automotive Applications



Product Range

Mono-Axial X7R Dielectric

(continued)

C	Tol. (%)	Lb Max (mm)	ØD Max (mm)	Clear Text Code without Lead configuration and Packaging ⁽¹⁾
100 Vdc (continued)				
0.15 µF	10	5.08	3.05	A154K20X7RH□□□□V
0.22 µF				A224K20X7RH□□□□V
0.33 µF		5.08	4.5 ⁽²⁾	A334K20X7RH□□□□V
0.47 µF				A474K20X7RH□□□□V
200 Vdc				
330 pF	10	3.81	3.81	A331K15X7RK□□□□V
470 pF				A471K15X7RK□□□□V
680 pF				A681K15X7RK□□□□V
1000 pF				A102K15X7RK□□□□V
1500 pF				A152K15X7RK□□□□V
2200 pF				A222K15X7RK□□□□V
3300 pF				A332K15X7RK□□□□V
4700 pF				A472K15X7RK□□□□V
6800 pF				A682K15X7RK□□□□V
0.010 µF				A103K15X7RK□□□□V
0.015 µF		A153K15X7RK□□□□V		
0.022 µF		A223K15X7RK□□□□V		
0.033 µF		5.08	3.05	A333K20X7RK□□□□V
0.047 µF				A473K20X7RK□□□□V
0.068 µF				A683K20X7RK□□□□V
0.10 µF				A683K20X7RK□□□□V

Note:

1. The four blank digits are filled with lead configuration and packaging, and please refer to ordering information
2. Inserted with 1210 chip

Capacitors - AEC-Q200 Approved



MULTILAYER CERAMIC DIPPED AXIAL AND RADIAL CAPACITORS
for Automotive Applications



Product Range

Mono-Axial X8R Dielectric

C	Tol. (%)	Lb Max (mm)	ØD Max (mm)	Clear Text Code without Lead configuration and Packaging ⁽¹⁾
50 Vdc				
470 pF	10	3.81	2.54	A471K15X8RF□□□□V
680 pF				A681K15X8RF□□□□V
1000 pF				A102K15X8RF□□□□V
1500 pF				A152K15X8RF□□□□V
2200 pF				A152K15X8RF□□□□V
3300 pF				A332K15X8RF□□□□V
4700 pF				A472K15X8RF□□□□V
6800 pF				A682K15X8RF□□□□V
0.010 µF				A103K15X8RF□□□□V
0.015 µF				A153K15X8RF□□□□V
0.022 µF		A223K15X8RF□□□□V		
0.033 µF		A333K15X8RF□□□□V		
0.047 µF		A473K15X8RF□□□□V		
0.056 µF		A563K15X8RF□□□□V		
0.068 µF		5.08	3.05	A683K20X8RF□□□□V
0.10 µF				A104K20X8RF□□□□V
0.15 µF		5.08	4.5 ⁽²⁾	A154K20X8RF□□□□V
0.22 µF				A224K20X8RF□□□□V
0.33 µF			A334K20X8RF□□□□V	

- Note:
1. The four blank digits are filled with lead configuration and packaging, and please refer to ordering information
 2. Inserted with 1210 chip

Capacitors - AEC-Q200 Approved



MULTILAYER CERAMIC DIPPED AXIAL AND RADIAL CAPACITORS

for Automotive Applications



Product Range

Mono-Kap C0G Dielectric

C	Tol. (%)	W _b Max (mm)	H Max (mm)	T Max (mm)	Clear Text Code without Lead configuration and Packaging ⁽¹⁾	
50 Vdc						
100 pF	5	3.81	3.81	2.54	K101J15C0GF□□□□V	
150 pF					K151J15C0GF□□□□V	
220 pF					K221J15C0GF□□□□V	
330 pF					K331J15C0GF□□□□V	
470 pF					K471J15C0GF□□□□V	
680 pF					K681J15C0GF□□□□V	
1000 pF					K102J15C0GF□□□□V	
1500 pF					K152J15C0GF□□□□V	
2200 pF					K222J15C0GF□□□□V	
3300 pF					K332J15C0GF□□□□V	
3900 pF					K392J15C0GF□□□□V	
4700 pF	5	5.08	5.08	3.18	K472J20C0GF□□□□V	
6800 pF					K682J20C0GF□□□□V	
0.01 μF					K103J20C0GF□□□□V	
100 Vdc						
100 pF	5	3.81	3.81	2.54	K101J15C0GH□□□□V	
150 pF					K151J15C0GH□□□□V	
220 pF					K221J15C0GH□□□□V	
330 pF					K331J15C0GH□□□□V	
470 pF					K471J15C0GH□□□□V	
680 pF					K681J15C0GH□□□□V	
1000 pF					K102J15C0GH□□□□V	
1500 pF		K152J15C0GH□□□□V				
1800 pF		K182J15C0GH□□□□V				
2200 pF		5.08	5.08	5.08	3.18	K222J20C0GH□□□□V
3300 pF						K332J20C0GH□□□□V
4700 pF						K472J20C0GH□□□□V
6800 pF						K682J20C0GH□□□□V
0.01 μF						K103J20C0GH□□□□V
200 Vdc						
100 pF	5	3.81	3.81	2.54	K101J15C0GK□□□□V	
150 pF					K151J15C0GK□□□□V	
220 pF					K221J15C0GK□□□□V	
330 pF					K331J15C0GK□□□□V	
470 pF					K471J15C0GK□□□□V	
680 pF					K681J15C0GK□□□□V	
1000 pF					K102J15C0GK□□□□V	

Note: 1. The four blank digits are filled with lead configuration and packaging, and please refer to ordering information

Capacitors - AEC-Q200 Approved



MULTILAYER CERAMIC DIPPED AXIAL AND RADIAL CAPACITORS

for Automotive Applications



Product Range

Mono-Kap X7R Dielectric

C	Tol. (%)	W _b Max (mm)	H Max (mm)	T Max (mm)	Clear Text Code without Lead configuration and Packaging ⁽¹⁾
50 Vdc					
470 pF	10	3.81	3.81	2.54	K471K15X7RF□□□□V
680 pF					K681K15X7RF□□□□V
1000 pF					K102K15X7RF□□□□V
1500 pF					K152K15X7RF□□□□V
2200 pF					K222K15X7RF□□□□V
3300 pF					K332K15X7RF□□□□V
4700 pF					K472K15X7RF□□□□V
6800 pF					K682K15X7RF□□□□V
0.010 μF					K103K15X7RF□□□□V
0.015 μF					K153K15X7RF□□□□V
0.022 μF					K223K15X7RF□□□□V
0.033 μF					K333K15X7RF□□□□V
0.047 μF					K473K15X7RF□□□□V
0.068 μF					K683K15X7RF□□□□V
0.10 μF					K104K15X7RF□□□□V
0.15 μF	K154K15X7RF□□□□V				
0.22 μF	10	5.08	5.08	3.18	K224K20X7RF□□□□V
0.33 μF					K334K20X7RF□□□□V
0.47 μF					K474K20X7RF□□□□V
0.68 μF					K684K20X7RF□□□□V
1.0 μF					K105K20X7RF□□□□V
100 Vdc					
470 pF	10	3.81	3.81	2.54	K471K15X7RH□□□□V
680 pF					K681K15X7RH□□□□V
1000 pF					K102K15X7RH□□□□V
1500 pF					K152K15X7RH□□□□V
2200 pF					K222K15X7RH□□□□V
3300 pF					K332K15X7RH□□□□V
4700 pF					K472K15X7RH□□□□V
6800 pF					K682K15X7RH□□□□V
0.010 μF					K103K15X7RH□□□□V
0.015 μF					K153K15X7RH□□□□V
0.022 μF					K223K15X7RH□□□□V
0.033 μF					K333K15X7RH□□□□V
0.047 μF					K473K15X7RH□□□□V
0.068 μF					K683K15X7RH□□□□V
0.10 μF					K104K15X7RH□□□□V

Note:

1. The four blank digits are filled with lead configuration and packaging, and please refer to ordering information



Capacitors - AEC-Q200 Approved

MULTILAYER CERAMIC DIPPED AXIAL AND RADIAL CAPACITORS
for Automotive Applications

Product Range
Mono-Kap X7R Dielectric
(continued)

C	Tol. (%)	W _b Max (mm)	H Max (mm)	T Max (mm)	Clear Text Code without Lead configuration and Packaging ⁽¹⁾
100 Vdc (continued)					
0.15 μF	10	5.08	5.08	3.18	K154K20X7RH□□□□V
0.22 μF					K224K20X7RH□□□□V
0.33 μF					K334K20X7RH□□□□V
0.47 μF					K474K20X7RH□□□□V
200 Vdc					
330 pF	10	3.81	3.81	2.54	K331K15X7RK□□□□V
470 pF					K471K15X7RK□□□□V
680 pF					K681K15X7RK□□□□V
1000 pF					K102K15X7RK□□□□V
1500 pF					K152K15X7RK□□□□V
2200 pF					K222K15X7RK□□□□V
3300 pF					K332K15X7RK□□□□V
4700 pF					K472K15X7RK□□□□V
6800 pF					K682K15X7RK□□□□V
0.010 μF					K103K15X7RK□□□□V
0.015 μF		K153K15X7RK□□□□V			
0.022 μF		K223K15X7RK□□□□V			
0.033 μF		5.08	5.08	3.18	K333K20X7RK□□□□V
0.047 μF					K473K20X7RK□□□□V
0.068 μF	K683K20X7RK□□□□V				
0.10 μF	K104K20X7RK□□□□V				

Note:

1. The four blank digits are filled with lead configuration and packaging, and please refer to ordering information

Capacitors - AEC-Q200 Approved



MULTILAYER CERAMIC DIPPED AXIAL AND RADIAL CAPACITORS
for Automotive Applications



Product Range

Mono-Axial X8R Dielectric

C	Tol. (%)	W _b Max (mm)	H Max (mm)	T Max (mm)	Clear Text Code without Lead configuration and Packaging ⁽¹⁾
50 Vdc					
470 pF	10	3.81	3.81	2.54	K471K15X8RF□□□□V
680 pF					K681K15X8RF□□□□V
1000 pF					K102K15X8RF□□□□V
1500 pF					K152K15X8RF□□□□V
2200 pF					K222K15X8RF□□□□V
3300 pF					K332K15X8RF□□□□V
4700 pF					K472K15X8RF□□□□V
6800 pF					K682K15X8RF□□□□V
0.010 μF					K103K15X8RF□□□□V
0.015 μF					K153K15X8RF□□□□V
0.022 μF					K223K15X8RF□□□□V
0.033 μF					K333K15X8RF□□□□V
0.047 μF					K473K15X8RF□□□□V
0.056 μF					K563K15X8RF□□□□V
0.068 μF	10	5.08	5.08	3.18	K683K20X8RF□□□□V
0.10 μF					K104K20X8RF□□□□V
0.15 μF					K154K20X8RF□□□□V
0.22 μF					K224K20X8RF□□□□V
0.33 μF					K334K20X8RF□□□□V

Note:
1. The four blank digits are filled with lead configuration and packaging, and please refer to ordering information

Capacitors - AEC-Q200 Approved

MULTILAYER CERAMIC DIPPED AXIAL AND RADIAL CAPACITORS
for Automotive Applications

WORLDWIDE SALES CONTACTS
THE AMERICAS
UNITED STATES

VISHAY AMERICAS
 ONE GREENWICH PLACE
 SHELTON, CT 06484
 UNITED STATES
 PH: +1-402-563-6866
 FAX: +1-402-563-6296

ASIA
SINGAPORE

VISHAY INTERTECHNOLOGY ASIA PTE LTD.
 37A TAMPINES STREET 92 #07-00
 SINGAPORE 528886
 PH: +65-6788-6668
 FAX: +65-6788-0988

P.R. CHINA

VISHAY CHINA CO., LTD.
 15D, SUN TONG INFOPORT PLAZA
 55 HUAI HAI WEST ROAD
 SHANGHAI 200030
 P.R. CHINA
 PH: +86-21-5258 5000
 FAX: +86-21-5258 7979

JAPAN

VISHAY JAPAN CO., LTD.
 SHIBUYA PRESTIGE BLDG. 4F
 3-12-22, SHIBUYA
 SHIBUYA-KU
 TOKYO 150-0002
 JAPAN
 PH: +81-3-5466-7150
 FAX: +81-3-5466-7160

EUROPE
GERMANY

VISHAY ELECTRONIC GMBH
 DR.-FELIX-ZANDMAN-PLATZ 1
 95100 SELB
 GERMANY
 PH: +49-9287-71-0
 FAX: +49-9287-70435

FRANCE

VISHAY S.A.
 199, BD DE LA MADELEINE
 06003 NICE, CEDEX 1
 FRANCE
 PH: +33-4-9337-2727
 FAX: +33-4-9337-2726

UNITED KINGDOM

VISHAY LTD.
 SUITE 6C, TOWER HOUSE
 ST. CATHERINE'S COURT
 SUNDERLAND ENTERPRISE PARK
 SUNDERLAND SR5 3XJ
 UNITED KINGDOM
 PH: +44-191-516-8584
 FAX: +44-191-549-9556

Capacitors - AEC-Q200 Approved

Компания «Океан Электроники» предлагает заключение долгосрочных отношений при поставках импортных электронных компонентов на взаимовыгодных условиях!

Наши преимущества:

- Поставка оригинальных импортных электронных компонентов напрямую с производств Америки, Европы и Азии, а так же с крупнейших складов мира;
- Широкая линейка поставок активных и пассивных импортных электронных компонентов (более 30 млн. наименований);
- Поставка сложных, дефицитных, либо снятых с производства позиций;
- Оперативные сроки поставки под заказ (от 5 рабочих дней);
- Экспресс доставка в любую точку России;
- Помощь Конструкторского Отдела и консультации квалифицированных инженеров;
- Техническая поддержка проекта, помощь в подборе аналогов, поставка прототипов;
- Поставка электронных компонентов под контролем ВП;
- Система менеджмента качества сертифицирована по Международному стандарту ISO 9001;
- При необходимости вся продукция военного и аэрокосмического назначения проходит испытания и сертификацию в лаборатории (по согласованию с заказчиком);
- Поставка специализированных компонентов военного и аэрокосмического уровня качества (Xilinx, Altera, Analog Devices, Intersil, Interpoint, Microsemi, Actel, Aeroflex, Peregrine, VPT, Syfer, Eurofarad, Texas Instruments, MS Kennedy, Miteq, Cobham, E2V, MA-COM, Hittite, Mini-Circuits, General Dynamics и др.);

Компания «Океан Электроники» является официальным дистрибьютором и эксклюзивным представителем в России одного из крупнейших производителей разъемов военного и аэрокосмического назначения «JONHON», а так же официальным дистрибьютором и эксклюзивным представителем в России производителя высокотехнологичных и надежных решений для передачи СВЧ сигналов «FORSTAR».



JONHON

«JONHON» (основан в 1970 г.)

Разъемы специального, военного и аэрокосмического назначения:

(Применяются в военной, авиационной, аэрокосмической, морской, железнодорожной, горно- и нефтедобывающей отраслях промышленности)

«FORSTAR» (основан в 1998 г.)

ВЧ соединители, коаксиальные кабели,
кабельные сборки и микроволновые компоненты:

(Применяются в телекоммуникациях гражданского и специального назначения, в средствах связи, РЛС, а так же военной, авиационной и аэрокосмической отраслях промышленности).



Телефон: 8 (812) 309-75-97 (многоканальный)

Факс: 8 (812) 320-03-32

Электронная почта: ocean@oceanchips.ru

Web: <http://oceanchips.ru/>

Адрес: 198099, г. Санкт-Петербург, ул. Калинина, д. 2, корп. 4, лит. А