

# N-Series

## Hydraulic Magnetic Circuit Breaker

### Product Highlights:

- 240 VAC, 277 VAC, 120/240 VAC
- UL 489 Compliant Sliding Terminal Barriers
- 22,000 Amps Max Interrupting Capacity
- 1 – 30 Amps Current Rating
- Optional Current Transformer
- EN60947-2 Certified

### Typical Applications:

- Telecom/Datacom
  - Power Distribution Units
  - Data Servers
  - Data Storage



### Resources:

#### Download 3D CAD Files

[IGS >](#) [STP >](#)

#### Watch Product Video



The high-performance N-Series hydraulic-magnetic circuit breaker is ideally suited for the rigors and confined spaces of telecom and datacom power distribution units and rack systems. Its innovative, low profile design features easily accessible load and line terminals and sliding barriers for effortless installation.

The optional current transformer allows for remote outlet metering and monitoring of power usage thus facilitating load adjustments and maximizing efficiency.

A patent pending, flush-rocker actuator and push-to-reset guard offer additional protection against accidental switching.



**Carling Technologies™**

Innovative Designs. Powerful Solutions.

**Carling Technologies, Inc.**

60 Johnson Avenue, Plainville, CT 06062

Email: [sales@carlingtech.com](mailto:sales@carlingtech.com)

Application Support: [team2@carlingtech.com](mailto:team2@carlingtech.com)

Phone: 860.793.9281 Fax: 860.793.9231

[www.carlingtech.com](http://www.carlingtech.com)

# N-Series Circuit Breaker

## DESIGN FEATURES

### CURRENT TRANSFORMER

Remote current sensing via molex connector

### UPPER ARC RUNNER

Optional, for 277 VAC rated breakers

### GRIDS (5x)

Arc deionizing splitter plates that increase arc voltage for quick interrupt

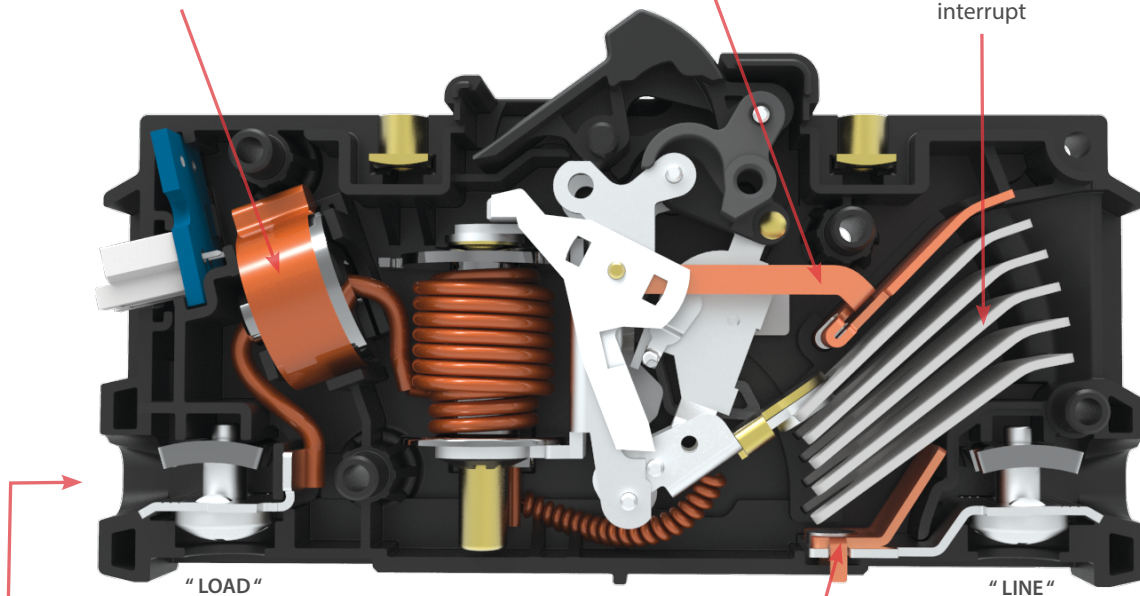

### TERMINAL

Allows for easy hook-up of wires on both sides of the breaker

### LOWER ARC RUNNER

Motivates arc off of the stationary contact

### SLIDING TERMINAL BARRIERS

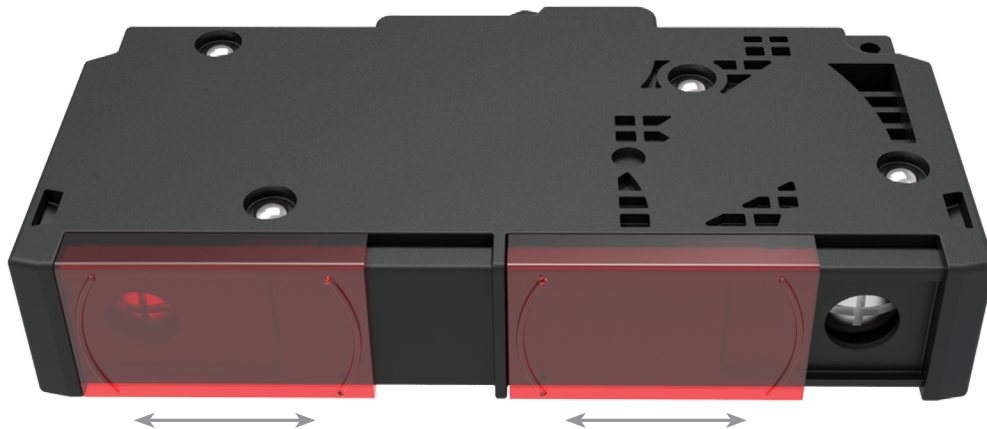

## Electrical Tables

**Table 1:** Voltage and Current Ratings

N-SERIES TABLE 1: ELECTRICAL RATINGS						
VOLTAGE	CURRENT (AMPS)	NUMBER OF POLES	INTERRUPT CAPACITY (AMPS)			
			UL 489		EN60947-2 (Ics & Icu)	
			1-20 A	21-30 A	1-20 A	21-30 A
120/240 VAC	1 - 30	2	10000	5000	5000	5000
240 VAC	1 - 20	1	22000	N/A	5000	5000
277 VAC	1 - 20	1	10000	N/A	N/A	N/A

**Table 2:** Time Delay

N-SERIES TABLE 2: TIME DELAY OPTIONS		
DELAY CURVE NUMBER	VOLTAGE	DESCRIPTION
21	50/60 Hz	Ultrashort
22	50/60 Hz	Short
24	50/60 Hz	Medium
26	50/60 Hz	Long
42	50/60 Hz	Hi-inrush, Short
44	50/60 Hz	Hi-inrush, Medium
46	50/60 Hz	Hi-inrush, Long

### Electrical: Impedance / Resistance

#### RESISTANCE, IMPEDANCE VALUES

Across Line and Load Terminals

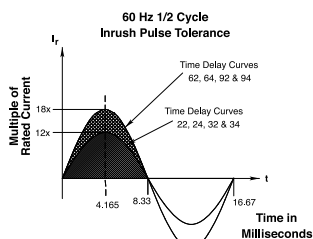
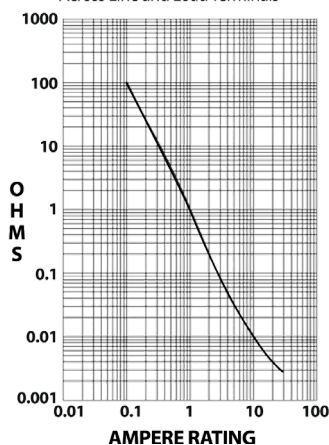

Current (amps)	Tolerance (%)
0.1 - 5.0	+/-15
5.1 - 30.0	+/-25

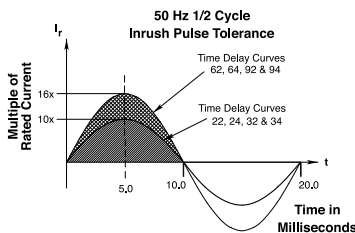

## Electrical

### Current Metering

Integrated current transformer.  
 Measurement range: 1-30 Amps.  
 Voltage output: 10mV per Amp according to the formula below:  
 $2 \text{ (Amp)} \leq I \leq 30 \text{ (Amp)}$   
 $V = 0.01 \cdot I \pm 2\%$

$$\left| \frac{\frac{V}{I} - \frac{V_{10}}{I_{10}}}{\frac{V_{10}}{I_{10}}} \right| \leq 0.85\%$$

Where V=CT output in volts  
 $V_{10}$ =CT output in volts with  $I=I_{10}=10 \text{ (A)}$ ;  $I$ =primary current in amperage (50/60 Hz). Phase shift between primary current and CT output is  $0.25 \pm 0.25^\circ$ . Maximum crest factor of primary current is 1.73. R1 shall be integrated in the breaker. R2 and R3 are provided by end user and external to the breaker.  
 Connection: below Load Terminal.  
 2-pin connector, Molex 35362-0250.  
 Mating Connector housing – Molex PN35507-0200.  
 (Current metering is available on AC rated devices only)

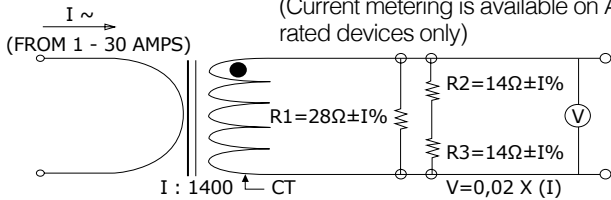

### Dielectric Strength

UL, CSA-1960V 50/60 Hz for one minute between all electrically isolated terminals. Comply with the 8mm spacing and 3750V 50/60 Hz dielectric requirements from hazardous voltage to operator accessible surfaces and between main circuits of adjacent poles per Publications EN 60950 and VDE 0805

### Insulation Resistance Overload

Minimum of 100 Megohms @ 500VDC  
 50 operations @ 600% of rated current for AC rated devices

### Interrupt Capacity

See table 1

## Mechanical

### Endurance

10,000 "On-Off" operations @ 6 per minute; with rated current & voltage  
 Trips on overload even when actuator is forcibly held in the "On" position

### Trip Free

The operating actuator moves positively to the "Off" position when an overload causes the breaker to trip

### Trip Indication

## Environmental

### Environmental Operating Temperature Vibration

MIL-PRF-55629 and MIL-STD-202G  
 -40°C to +85°C  
 Withstands 0.06" excursion from 10-55 Hz and 10Gs 55-500 Hz at rated current per MIL-PRF-55629 and MIL-STD-202G, Method 204D, Test Condition A. Instantaneous and ultra-short curves tested at 90% of rated current

### Shock

Withstands 50 Gs, 6 ms saw tooth while carrying rated current per MIL-PRF-55629 and MIL-STD-202G, Method 213B, test condition "I". Instantaneous and ultra short curves tested at 90% of rated current

### Thermal Shock

MIL-PRF-55629 and MIL-STD-202G, Method 107G, Condition A (5-cycles at -55°C to +25°C to +85°C to +25°C)

### Moisture Resistance

MIL-PRF-55629 and MIL-STD-202G, Method 106G, i.e., Ten 24-hour cycles at +25°C to +65°C, 80-98% RH Method 101, Condition A (90-95% RH @ 5% NaCl Solution, 96hrs)

### Salt Spray

## Physical

### Number of Poles Termination

1 - 2 poles  
 Wire ready and touch proof wire clamp (See Figure 1). Accepts up to (2) #10 AWG wires per terminal. Designed for use with solid, stranded and flexible stranded wires, with or without ferrule or pin terminals. Also accepts straight fork and flanged fork terminals.

### Termination Torque Termination Barrier

15-20 in-lbs (Line & Load terminals)  
 Integral sliding barrier to comply with spacing requirements (See figure 1)

### Mounting

Threaded Insert: #6-32 UNC-2B, or M3X0.5-6H B ISO (2 per Pole)

### Insert Termination Torque Actuator

7-9 in-lbs  
 Rocker, with or without guard (See figures 1, 2, and 4)

### Internal Circuit Config. Materials

Series Trip  
 Housing - Glass Filled Polyester  
 Rocker - Nylon  
 Line/Load Terminals - Copper Alloy; Bright Acid Tin Plated

### Weight Standard Color

~107 grams (~3.76 ounces) per pole  
 Housing - Black. Rocker - Several (See ordering scheme for colors)

## Agency Approvals

UL 489, cUL, TUV EN60947-2

\*Manufacturer reserves the right to change product specification without prior notice.



Form & Fit

Figure 1. N-Series 1-Pole Construction

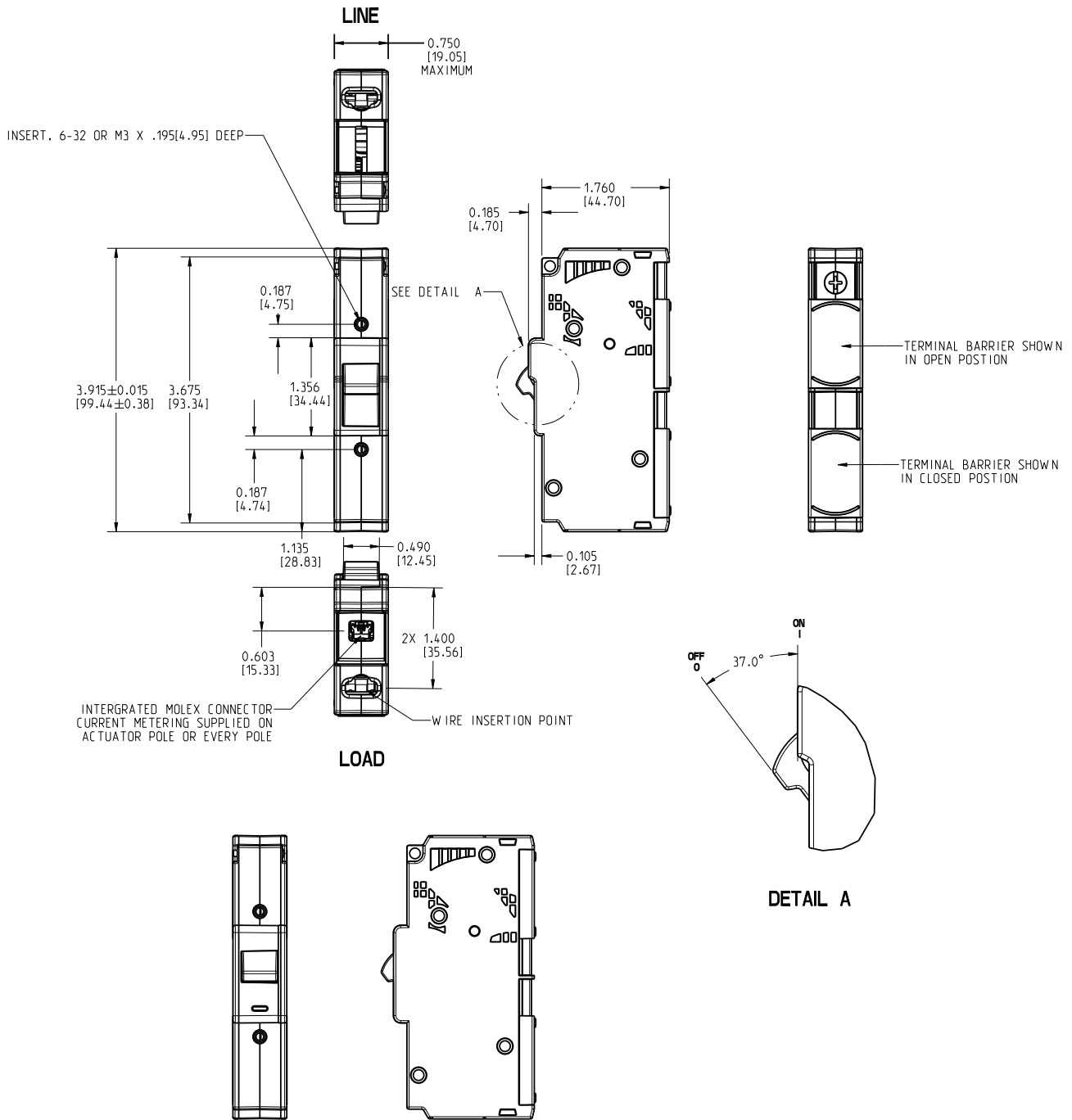

PUSH TO RESET  
ACTUATOR

Notes:

- 1 All dimensions are in inches [millimeters].
- 2 Tolerance  $\pm 0.020$  [.51] unless otherwise specified.

Form & Fit

Figure 2. N-Series 2-Pole Construction

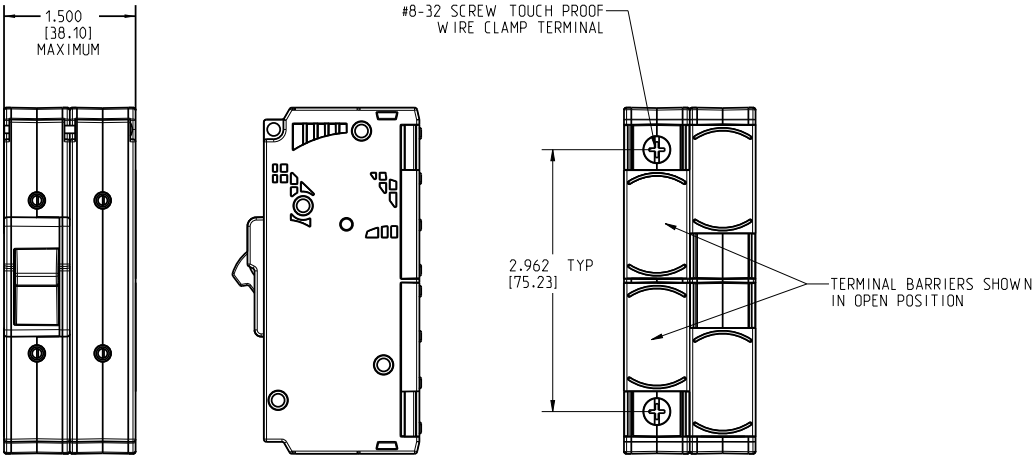
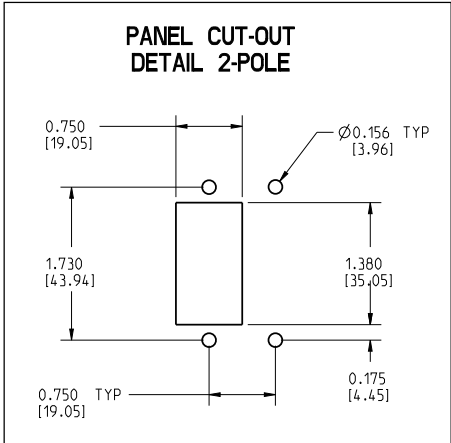

Figure 3. N-Series Panel Cut-Out



- Notes:
- 1 All dimensions are in inches [millimeters].
  - 2 Tolerance  $\pm 0.020$  [.51] unless otherwise specified.

## Time Delay Curves

**Ultrashort - AC 21**

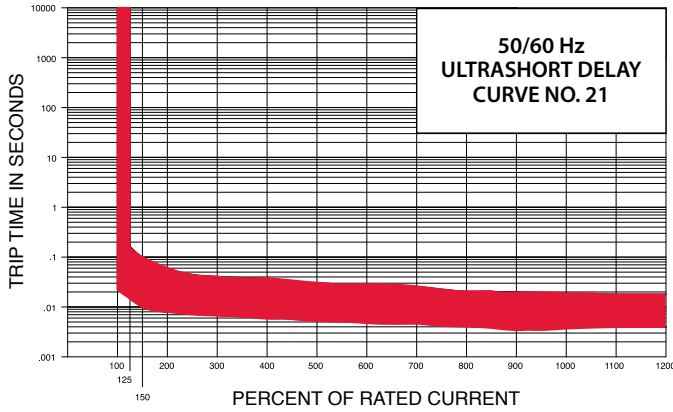

**Short - AC 22**

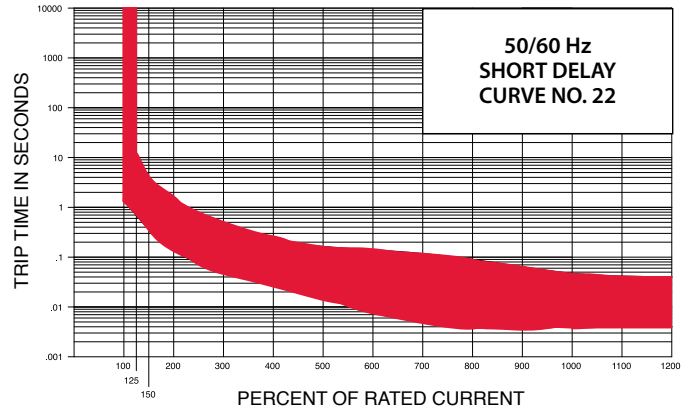

**Medium - AC 24**

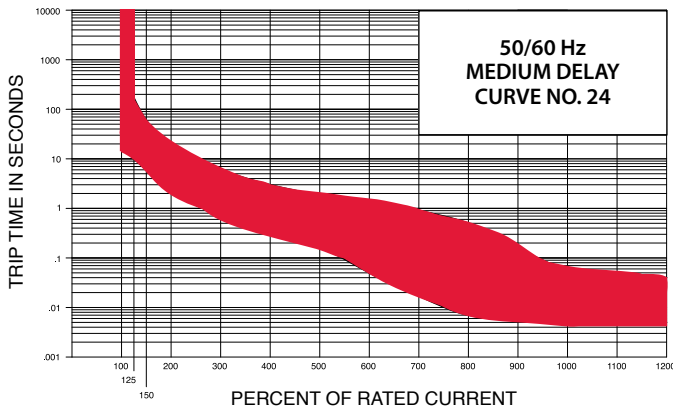

**Long - AC 26**

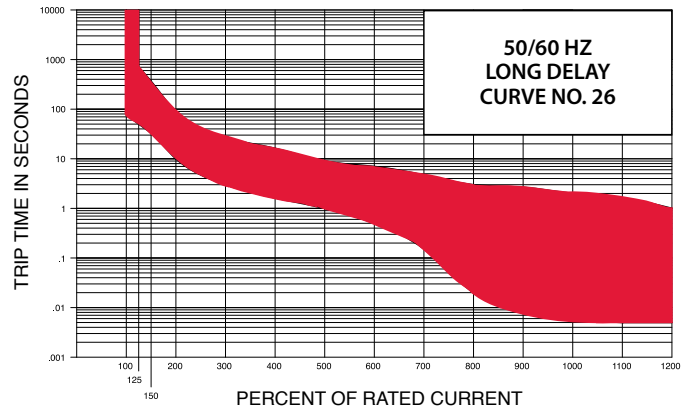



## Time Delay Curves

**Hi-Inrush Short - AC 42**

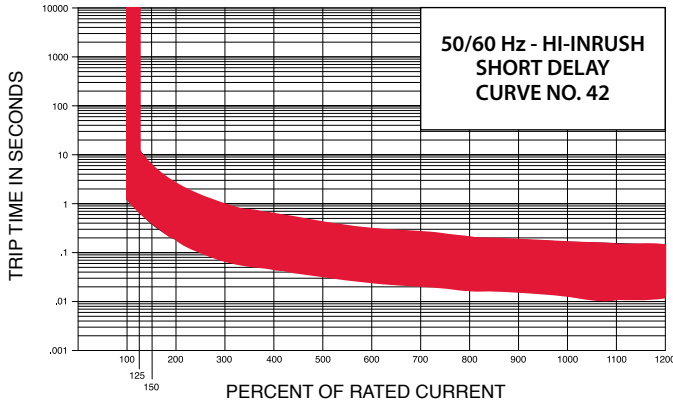

**Hi-Inrush Medium - AC 44**

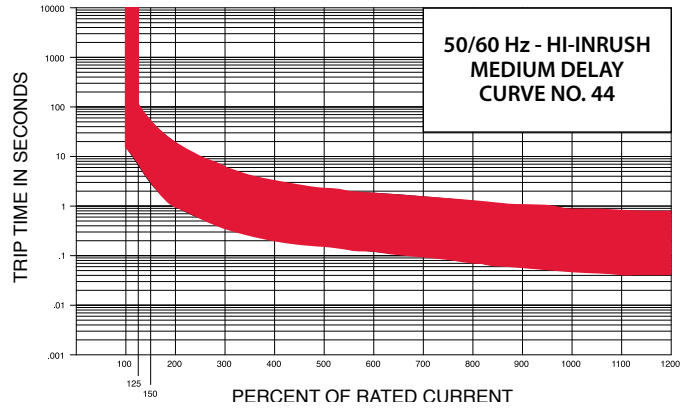

**Hi-Inrush Long - AC 46**

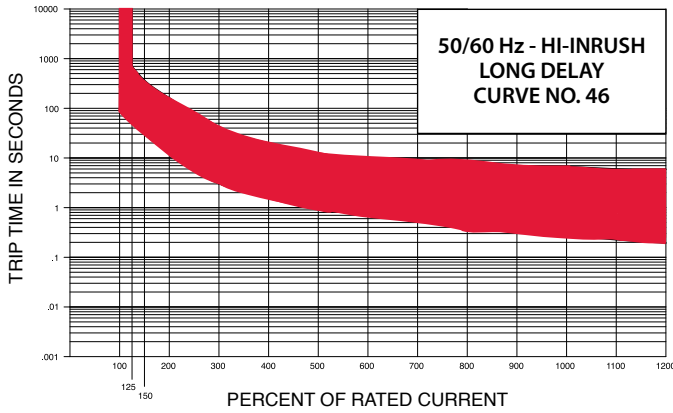

## Authorized Sales Representatives

Click on the group name on the map below to find your local representative or visit [www.carlingtech.com/findarep](http://www.carlingtech.com/findarep).

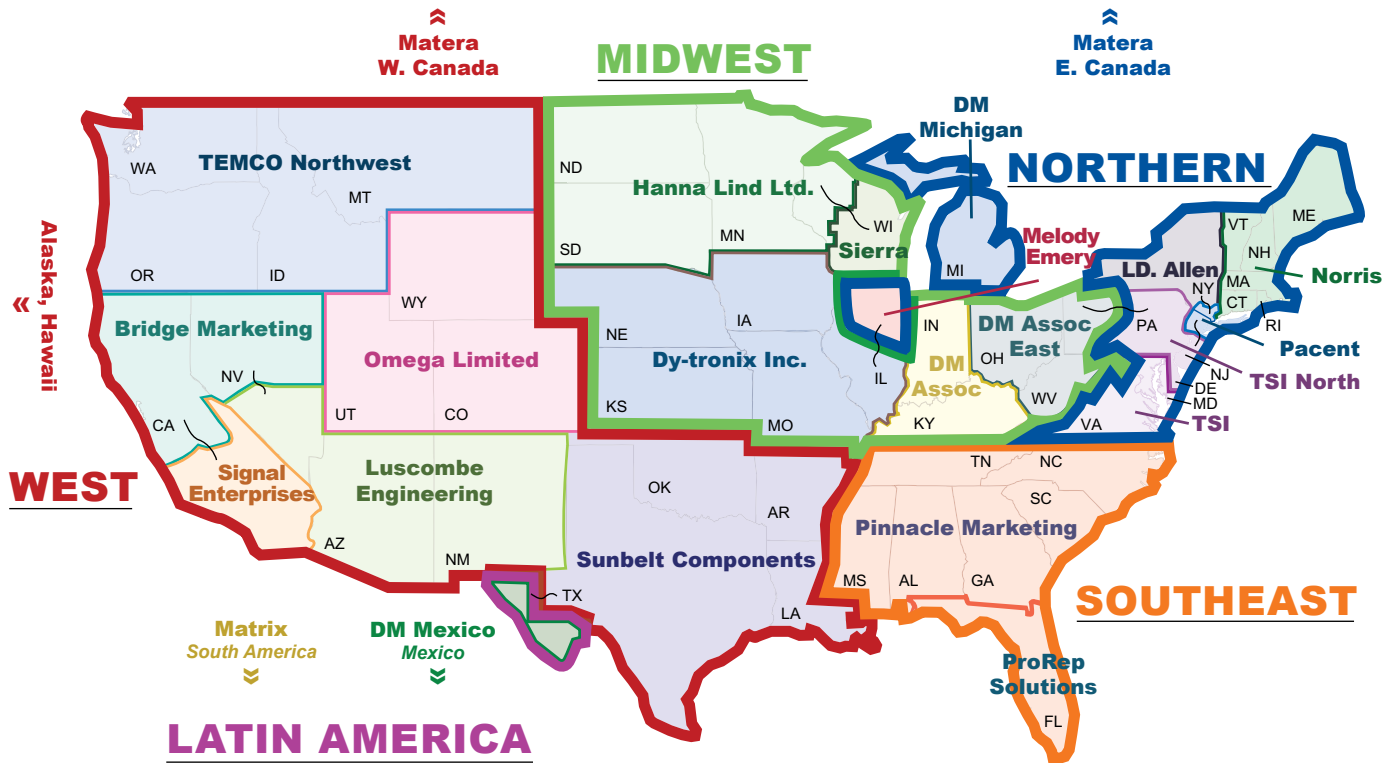

Americas



Europe  
Middle East  
Africa



Asia-Pacific  
Oceania

## About Carling

Founded in 1920, Carling Technologies is a leading manufacturer of electrical and electronic switches and assemblies, circuit breakers, electronic controls, power distribution units, and multiplexed power distribution systems. With four ISO registered manufacturing facilities and technical sales offices worldwide, Carling Technologies Sales, Service and Engineering teams do much more than manufacture electrical components, they engineer powerful solutions! To learn more about Carling please visit [www.carlingtech.com/company-profile](http://www.carlingtech.com/company-profile).

To view all of Carling’s environmental, quality, health & safety certifications please visit [www.carlingtech.com/environmental-certifications](http://www.carlingtech.com/environmental-certifications)



## **Worldwide Headquarters**

Carling Technologies, Inc.  
60 Johnson Avenue, Plainville, CT 06062  
**Phone:** 860.793.9281 **Fax:** 860.793.9231  
**Email:** sales@carlingtech.com

**Northern Region Sales Office:** nrsm@carlingtech.com  
**Southeast Region Sales Office:** sersm@carlingtech.com  
**Midwest Region Sales Office:** mrsms@carlingtech.com  
**West Region Sales Office:** wrsm@carlingtech.com  
**Latin America Sales Office:** larsm@carlingtech.com

## **Asia-Pacific Headquarters**

Carling Technologies, Asia-Pacific Ltd.,  
Kowloon, Hong Kong  
**Phone:** Int + 852-2737-2277 **Fax:** Int + 852-2736-9332  
**Email:** sales@carlingtech.com.hk

**Shenzhen, China:** shenzhen@carlingtech.com  
**Shanghai, China:** shanghai@carlingtech.com  
**Pune, India:** india@carlingtech.com  
**Kaohsiung, Taiwan:** taiwan@carlingtech.com  
**Yokohama, Japan:** japan@carlingtech.com

## **Europe | Middle East | Africa Headquarters**

Carling Technologies LTD  
4 Airport Business Park, Exeter Airport,  
Clyst Honiton, Exeter, Devon, EX5 2UL, UK  
**Phone:** Int + 44 1392.364422 **Fax:** Int + 44 1392.364477  
**Email:** ltd.sales@carlingtech.com

**Germany:** gmbh@carlingtech.com  
**France:** sas@carlingtech.com



**Carling Technologies™**

Innovative Designs. Powerful Solutions.

Компания «Океан Электроники» предлагает заключение долгосрочных отношений при поставках импортных электронных компонентов на взаимовыгодных условиях!

Наши преимущества:

- Поставка оригинальных импортных электронных компонентов напрямую с производств Америки, Европы и Азии, а так же с крупнейших складов мира;
- Широкая линейка поставок активных и пассивных импортных электронных компонентов (более 30 млн. наименований);
- Поставка сложных, дефицитных, либо снятых с производства позиций;
- Оперативные сроки поставки под заказ (от 5 рабочих дней);
- Экспресс доставка в любую точку России;
- Помощь Конструкторского Отдела и консультации квалифицированных инженеров;
- Техническая поддержка проекта, помощь в подборе аналогов, поставка прототипов;
- Поставка электронных компонентов под контролем ВП;
- Система менеджмента качества сертифицирована по Международному стандарту ISO 9001;
- При необходимости вся продукция военного и аэрокосмического назначения проходит испытания и сертификацию в лаборатории (по согласованию с заказчиком);
- Поставка специализированных компонентов военного и аэрокосмического уровня качества (Xilinx, Altera, Analog Devices, Intersil, Interpoint, Microsemi, Actel, Aeroflex, Peregrine, VPT, Syfer, Eurofarad, Texas Instruments, MS Kennedy, Miteq, Cobham, E2V, MA-COM, Hittite, Mini-Circuits, General Dynamics и др.);

Компания «Океан Электроники» является официальным дистрибьютором и эксклюзивным представителем в России одного из крупнейших производителей разъемов военного и аэрокосмического назначения «JONHON», а так же официальным дистрибьютором и эксклюзивным представителем в России производителя высокотехнологичных и надежных решений для передачи СВЧ сигналов «FORSTAR».



## JONHON

«JONHON» (основан в 1970 г.)

Разъемы специального, военного и аэрокосмического назначения:

(Применяются в военной, авиационной, аэрокосмической, морской, железнодорожной, горно- и нефтедобывающей отраслях промышленности)

«FORSTAR» (основан в 1998 г.)

ВЧ соединители, коаксиальные кабели, кабельные сборки и микроволновые компоненты:

(Применяются в телекоммуникациях гражданского и специального назначения, в средствах связи, РЛС, а так же военной, авиационной и аэрокосмической отраслях промышленности).



Телефон: 8 (812) 309-75-97 (многоканальный)

Факс: 8 (812) 320-03-32

Электронная почта: [ocean@oceanchips.ru](mailto:ocean@oceanchips.ru)

Web: <http://oceanchips.ru/>

Адрес: 198099, г. Санкт-Петербург, ул. Калинина, д. 2, корп. 4, лит. А