STEP-UP DC/DC CONTROLLER

NO.EA-109-0607

OUTLINE

The R1212D Series are CMOS-based PWM step-up DC/DC converter controllers with low supply current.

Each of the R1212D Series consists of an oscillator, a PWM comparator circuit, a reference voltage unit, an error amplifier, a reference current unit, a protection circuit, and an under voltage lockout (UVLO) circuit. A low ripple, high efficiency step-up DC/DC converter can be composed of this IC with some external components, or an inductor, a diode, a power MOSFET, divider resistors, and capacitors.

Maximum duty cycle and the soft start time are easily adjustable with external resistors and capacitors. In terms of maximum duty cycle, with or without internal limit can be set by mask options. As for the protection circuit, after the soft-starting time, if the maximum duty cycle is continued for a certain period, the R1212D Series latch the external driver with its off state, or the latch-type protection circuit works.

The delay time for latch the state can be set with an external capacitor.

To release the protection circuit, restart with power-on (Voltage supplier is equal or less than UVLO detector threshold level).

FEATURES

- Input Voltage Range 2.2V to 5.5V
- Built-in Latch-type Protection Function (Output Delay Time can be set with an external capacitor)
- Two Options of Basic Oscillator Frequency 700kHz, 1.4MHz, 300kHz
- Maximum Duty Cycle/Soft-start time Adjustable with external capacitors
(If internal limit is set by version, Typ. 90% or Typ. 91.5%)
- High Reference Voltage Accuracy $\pm 1.5\%$
- U.V.L.O. Threshold level Typ. 1.9V/2.1V/2.8V by mask option
- Small Temperature Coefficient of Reference Voltage ... Typ. $\pm 150\text{ppm}/^\circ\text{C}$
- Package SON-8 (t=Max. 0.9mm)

APPLICATIONS

- Constant Voltage Power Source for portable equipment.
- Constant Voltage Power Source for LCD and CCD.

BLOCK DIAGRAM

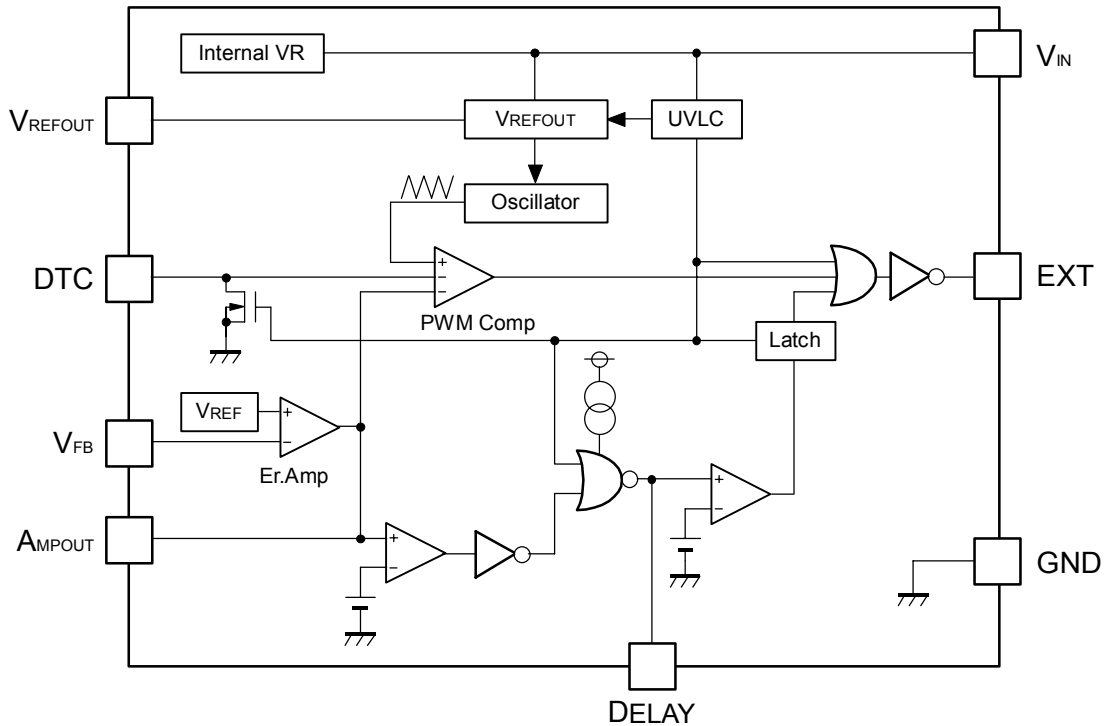

SELECTION GUIDE

In the R1212D Series, the oscillator frequency, UVLO detector threshold, and with/without internal limit of maximum duty cycle can be selected at the user's request.

The selection can be made with designating the part number as shown below;

R1212D10xx-TR-x ←Part Number
 ↑ ↑
 a b

Code	Contents		
a	Oscillator Frequency	UVLO Detector Threshold	Internal Maximum Duty Limit
0A	Typ. 700kHz	Typ. 1.9V	No
0B	Typ. 1.4MHz	Typ. 1.9V	No
1A	Typ. 700kHz	Typ. 2.1V	Typ. 90%
1C	Typ. 300kHz	Typ. 2.1V	Typ. 91.5%
2A	Typ. 700kHz	Typ. 2.8V	Typ. 90%
2C	Typ. 300kHz	Typ. 2.8V	Typ. 91.5%
b	Designation of composition of pin plating -F: Lead free plating		

PIN CONFIGURATION

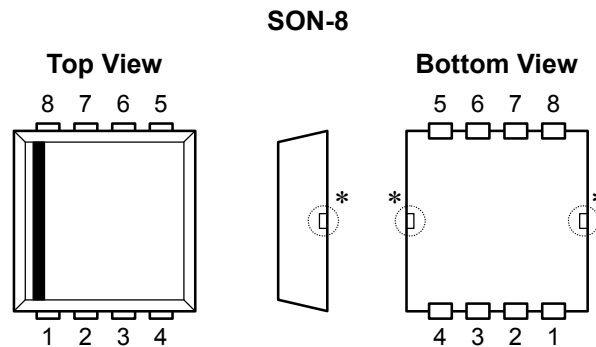

PIN DESCRIPTION

Pin No	Symbol	Description
1	EXT	External FET Drive Pin (CMOS Output)
2	GND	Ground Pin
3	DTC	Pin for Setting Maximum Duty Cycle and Soft start time
4	DELAY	Pin for External Capacitor (for Setting Output Delay of Protection)
5	V_{FB}	Feedback Pin for monitoring Output Voltage
6	V_{REFOUT}	Reference Voltage Output Pin
7	AMPOUT	Amplifier Output Pin
8	V_{IN}	Power Supply Pin for the IC

ABSOLUTE MAXIMUM RATINGS

(GND=0V)

Symbol	Item	Rating	Unit
V_{IN}	V_{IN} Pin Voltage	6.5	V
V_{EXT}	EXT Pin Output Voltage	$-0.3 \sim V_{IN}+0.3$	V
V_{DLY}	DELAY Pin Voltage	$-0.3 \sim V_{IN}+0.3$	V
V_{REFOUT}	V_{REFOUT} Pin Voltage	$-0.3 \sim V_{IN}+0.3$	V
V_{AMP}	AMPOUT Pin Voltage	$-0.3 \sim V_{IN}+0.3$	V
V_{DTC}	DTC Pin Voltage	$-0.3 \sim V_{IN}+0.3$	V
V_{FB}	V_{FB} Pin Voltage	$-0.3 \sim V_{IN}+0.3$	V
I_{AMP}	AMPOUT Pin Current	± 10	V
I_{ROUT}	V_{REFOUT} Pin Current	30	mA
I_{EXT}	EXT Pin Inductor Drive Output Current	± 80	mA
P_D	Power Dissipation (SON-8)* ¹	480	mW
T_{opt}	Operating Temperature Range	$-40 \sim +85$	°C
T_{stg}	Storage Temperature Range	$-55 \sim +125$	°C

*1) For Power Dissipation, please refer to PACKAGE INFORMATION to be described.

ELECTRICAL CHARACTERISTICS

• R1212D100A

T_{opt}=25°C

Symbol	Item	Conditions	Min.	Typ.	Max.	Unit
V _{IN}	Operating Input Voltage		2.2		5.5	V
V _{FB}	V _{FB} Voltage Tolerance	V _{IN} =3.3V	0.985	1.000	1.015	V
ΔV _{FB} /ΔV _{IN}	V _{FB} Voltage Line Regulation	V _{IN} : from 2.2V to 5.5V		3		mV
ΔV _{FB} /ΔT _{opt}	V _{FB} Voltage Temperature Coefficient	-40°C ≤ T _{opt} ≤ 85°C		±150		ppm/°C
I _{FB}	V _{FB} Input Current	V _{IN} =5.5V, V _{FB} =0V or 5.5V	-0.1		0.1	μA
A _v	Open Loop Voltage Gain	V _{IN} =3.3V		100		dB
f _r	Unity Gain Frequency Band	V _{IN} =3.3V, A _v =0		1.0		MHz
f _{osc}	Oscillator Frequency	V _{IN} =3.3V, V _{DLY} =V _{FB} =0V	595	700	805	KHz
Δf _{osc} /ΔV _{IN}	Oscillator Frequency Line Regulation	V _{IN} : from 2.2V to 5.5V		50		KHz
Δf _{osc} /ΔT _{opt}	Oscillator Frequency Temperature Coefficient	-40°C ≤ T _{opt} ≤ 85°C		±1.0		KHz/°C
I _{DD1}	Supply Current 1	V _{IN} =5.5V, V _{DLY} =V _{FB} =0V EXT at no load		600	1000	μA
V _{REFOUT}	V _{REFOUT} Voltage	V _{IN} =3.3V, I _{ROUT} =1mA	1.478	1.500	1.522	V
I _{OUT}	V _{REFOUT} Maximum Output Current	V _{IN} =3.3V	10			mA
ΔV _{REFOUT} /ΔV _{IN}	V _{REFOUT} Line Regulation	V _{IN} : from 2.2V to 5.5V		5	10	mV
ΔV _{REFOUT} /ΔI _{ROUT}	V _{REFOUT} Load Regulation	V _{IN} =3.3V, I _{ROUT} : from 0.1mA to 5.0mA		6	15	mV
I _{lim}	V _{REFOUT} Short Current Limit	V _{IN} =3.3V, V _{REFOUT} =0V		20		mA
ΔV _{REFOUT} /ΔT _{opt}	V _{REFOUT} Voltage Temperature Coefficient	-40°C ≤ T _{opt} ≤ 85°C		±150		ppm/°C
R _{EXTH}	EXT "H" ON Resistance	V _{IN} =3.3V, I _{EXT} =-50mA		2.5	6.0	Ω
R _{EXTL}	EXT "L" ON Resistance	V _{IN} =3.3V, I _{EXT} =50mA		1.5	4.0	Ω
t _r	EXT Rising Time	V _{IN} =3.3V, C _L =1000pF		12		ns
t _f	EXT Falling Time	V _{IN} =3.3V, C _L =1000pF		8		ns
I _{DLY1}	DELAY Pin Charge Current	V _{IN} =3.3V, V _{DLY} =V _{FB} =0V	3.0	5.5	8.0	μA
I _{DLY2}	DELAY Pin Discharge Current	V _{IN} =V _{FB} =2.2V, V _{DLY} =0.1V	0.08	0.20	0.36	mA
V _{DLY}	DELAY Pin Detector Threshold	V _{IN} =3.3V, V _{FB} =0V, V _{DLY} =0V to 2V	0.95	1.00	1.05	V
V _{UVLO1}	UVLO Detector Threshold	V _{IN} =3.3V to 0V, V _{DLY} =V _{FB} =0V	1.8	1.9	2.0	V
V _{UVLO2}	UVLO Released Voltage	V _{IN} =0V to 3.3V, V _{DLY} =V _{FB} =0V		V _{UVLO1} + 0.2	2.2	V
V _{DTC0}	Duty=0% DTC Pin Voltage	V _{IN} =3.3V	0.05	0.18	0.25	V
V _{DTC20}	Duty=20% DTC Pin Voltage	V _{IN} =3.3V		0.3		V
V _{DTC80}	Duty=80% DTC Pin Voltage	V _{IN} =3.3V		0.75		V
V _{DTC100}	Duty=100% DTC Pin Voltage	V _{IN} =3.3V	0.80	0.87	1.00	V
I _{AMPH}	AMP "H" Output Current	V _{IN} =3.3V, V _{AMP} =1.0V, V _{FB} =0.9V	0.5	1.0	1.8	mA
I _{AMPL}	AMP "L" Output Current	V _{IN} =3.3V, V _{AMP} =1.0V, V _{FB} =1.1V	60	100	160	μA

● R1212D100B

T_{opt}=25°C

Symbol	Item	Conditions	Min.	Typ.	Max.	Unit
V _{IN}	Operating Input Voltage		2.2		5.5	V
V _{FB}	V _{FB} Voltage Tolerance	V _{IN} =3.3V	0.985	1.000	1.015	V
ΔV _{FB} /ΔV _{IN}	V _{FB} Voltage Line Regulation	V _{IN} : from 2.2V to 5.5V		3		mV
ΔV _{FB} /ΔT _{opt}	V _{FB} Voltage Temperature Coefficient	-40°C ≤ T _{opt} ≤ 85°C		±150		ppm/°C
I _{FB}	V _{FB} Input Current	V _{IN} =5.5V, V _{FB} =0V or 5.5V	-0.1		0.1	μA
A _v	Open Loop Voltage Gain	V _{IN} =3.3V		100		dB
f _r	Unity Gain Frequency Band	V _{IN} =3.3V, A _v =0		1.0		MHz
f _{osc}	Oscillator Frequency	V _{IN} =3.3V, V _{DLY} =V _{FB} =0V	1.19	1.40	1.61	MHz
Δf _{osc} /ΔV _{IN}	Oscillator Frequency Line Regulation	V _{IN} : from 2.2V to 5.5V		100		KHz
Δf _{osc} /ΔT _{opt}	Oscillator Frequency Temperature Coefficient	-40°C ≤ T _{opt} ≤ 85°C		±2.0		KHz/°C
I _{DD1}	Supply Current 1	V _{IN} =5.5V, V _{DLY} =V _{FB} =0V EXT at no load		900	1800	μA
V _{REFOUT}	V _{REFOUT} Voltage	V _{IN} =3.3V, I _{ROUT} =1mA	1.478	1.500	1.522	V
I _{OUT}	V _{REFOUT} Maximum Output Current	V _{IN} =3.3V	10			mA
ΔV _{REFOUT} /ΔV _{IN}	V _{REFOUT} Line Regulation	V _{IN} : from 2.2V to 5.5V		5	10	mV
ΔV _{REFOUT} /ΔI _{ROUT}	V _{REFOUT} Load Regulation	V _{IN} =3.3V, I _{ROUT} : from 0.1mA to 5.0mA		6	15	mV
I _{lim}	V _{REFOUT} Short Current Limit	V _{IN} =3.3V, V _{REFOUT} =0V		20		mA
ΔV _{REFOUT} /ΔT _{opt}	V _{REFOUT} Voltage Temperature Coefficient	-40°C ≤ T _{opt} ≤ 85°C		±150		ppm/°C
R _{EXTH}	EXT "H" ON Resistance	V _{IN} =3.3V, I _{EXT} =-50mA		2.5	6.0	Ω
R _{EXTL}	EXT "L" ON Resistance	V _{IN} =3.3V, I _{EXT} =50mA		1.5	4.0	Ω
t _r	EXT Rising Time	V _{IN} =3.3V, C _L =1000pF		12		ns
t _f	EXT Falling Time	V _{IN} =3.3V, C _L =1000pF		8		ns
I _{DLY1}	DELAY Pin Charge Current	V _{IN} =3.3V, V _{DLY} =V _{FB} =0V	3.0	5.5	8.0	μA
I _{DLY2}	DELAY Pin Discharge Current	V _{IN} =V _{FB} =2.2V, V _{DLY} =0.1V	0.08	0.20	0.36	mA
V _{DLY}	DELAY Pin Detector Threshold	V _{FB} =0V, V _{DLY} =0V to 2V	0.95	1.00	1.05	V
V _{UVLO1}	UVLO Detector Threshold	V _{IN} =3.3V to 0V, V _{DLY} =V _{FB} =0V	1.8	1.9	2.0	V
V _{UVLO2}	UVLO Released Voltage	V _{IN} =0V to 3.3V, V _{DLY} =V _{FB} =0V		V _{UVLO1} +0.2	2.2	V
V _{DTC0}	Duty=0% DTC Pin Voltage	V _{IN} =3.3V	0.05	0.18	0.25	V
V _{DTC20}	Duty=20% DTC Pin Voltage	V _{IN} =3.3V		0.3		V
V _{DTC80}	Duty=80% DTC Pin Voltage	V _{IN} =3.3V		0.75		V
V _{DTC100}	Duty=100% DTC Pin Voltage	V _{IN} =3.3V	0.80	0.87	1.00	V
I _{AMPH}	AMP "H" Output Current	V _{IN} =3.3V, V _{AMP} =1.0V, V _{FB} =0.9V	0.5	1.0	1.8	mA
I _{AMPL}	AMP "L" Output Current	V _{IN} =3.3V, V _{AMP} =1.0V, V _{FB} =1.1V	60	100	160	μA

R1212D

• R1212D101A

T_{opt}=25°C

Symbol	Item	Conditions	Min.	Typ.	Max.	Unit
V _{IN}	Operating Input Voltage		2.2		5.5	V
V _{FB}	V _{FB} Voltage Tolerance	V _{IN} =3.3V	0.985	1.000	1.015	V
ΔV _{FB} /ΔV _{IN}	V _{FB} Voltage Line Regulation	V _{IN} : from 2.2V to 5.5V		3		mV
ΔV _{FB} /ΔT _{opt}	V _{FB} Voltage Temperature Coefficient	-40°C ≤ T _{opt} ≤ 85°C		±150		ppm/°C
I _{FB}	V _{FB} Input Current	V _{IN} =5.5V, V _{FB} =0V or 5.5V	-0.1		0.1	μA
A _v	Open Loop Voltage Gain	V _{IN} =3.3V		100		dB
f _r	Unity Gain Frequency Band	V _{IN} =3.3V, A _v =0		1.0		MHz
f _{osc}	Oscillator Frequency	V _{IN} =3.3V, V _{DLY} =V _{FB} =0V	595	700	805	KHz
Δf _{osc} /ΔV _{IN}	Oscillator Frequency Line Regulation	V _{IN} : from 2.2V to 5.5V		50		KHz
Δf _{osc} /ΔT _{opt}	Oscillator Frequency Temperature Coefficient	-40°C ≤ T _{opt} ≤ 85°C		±1.0		KHz/°C
I _{DD1}	Supply Current 1	V _{IN} =5.5V, V _{DLY} =V _{FB} =0V EXT at no load		600	1000	μA
V _{REFOUT}	V _{REFOUT} Voltage	V _{IN} =3.3V, I _{ROUT} =1mA	1.478	1.500	1.522	V
I _{OUT}	V _{REFOUT} Maximum Output Current	V _{IN} =3.3V	10			mA
ΔV _{REFOUT} /ΔV _{IN}	V _{REFOUT} Line Regulation	V _{IN} : from 2.2V to 5.5V		5	10	mV
ΔV _{REFOUT} /ΔI _{ROUT}	V _{REFOUT} Load Regulation	V _{IN} =3.3V, I _{ROUT} : from 0.1mA to 5.0mA		6	15	mV
I _{lim}	V _{REFOUT} Short Current Limit	V _{IN} =3.3V, V _{REFOUT} =0V		20		mA
ΔV _{REFOUT} /ΔT _{opt}	V _{REFOUT} Voltage Temperature Coefficient	-40°C ≤ T _{opt} ≤ 85°C		±150		ppm/°C
R _{EXTH}	EXT "H" ON Resistance	V _{IN} =3.3V, I _{EXT} =-50mA		2.5	6.0	Ω
R _{EXTL}	EXT "L" ON Resistance	V _{IN} =3.3V, I _{EXT} =50mA		1.5	4.0	Ω
t _r	EXT Rising Time	V _{IN} =3.3V, C _L =1000pF		12		ns
t _f	EXT Falling Time	V _{IN} =3.3V, C _L =1000pF		8		ns
I _{DLY1}	DELAY Pin Charge Current	V _{IN} =3.3V, V _{DLY} =V _{FB} =0V	3.0	5.5	8.0	μA
I _{DLY2}	DELAY Pin Discharge Current	V _{IN} =V _{FB} =2.2V, V _{DLY} =0.1V	0.08	0.20	0.36	mA
V _{DLY}	DELAY Pin Detector Threshold	V _{IN} =3.3V, V _{FB} =0V, V _{DLY} =0V to 2V	0.95	1.00	1.05	V
V _{UVLO1}	UVLO Detector Threshold	V _{IN} =3.3V to 0V, V _{DLY} =V _{FB} =0V	2.0	2.1	2.2	V
V _{UVLO2}	UVLO Released Voltage	V _{IN} =0V to 3.3V, V _{DLY} =V _{FB} =0V		V _{UVLO1} +0.2	2.45	V
V _{DTC0}	Duty=0% DTC Pin Voltage	V _{IN} =3.3V	0.05	0.18	0.25	V
V _{DTC20}	Duty=20% DTC Pin Voltage	V _{IN} =3.3V		0.3		V
V _{DTC80}	Duty=80% DTC Pin Voltage	V _{IN} =3.3V		0.75		V
Maxduty	Maximum Duty Cycle	V _{IN} =3.3V	84	90	96	%
I _{AMPH}	AMP "H" Output Current	V _{IN} =3.3V, V _{AMP} =1.0V, V _{FB} =0.9V	0.5	1.0	1.8	mA
I _{AMPL}	AMP "L" Output Current	V _{IN} =3.3V, V _{AMP} =1.0V, V _{FB} =1.1V	60	100	160	μA

● R1212D101C

T_{opt}=25°C

Symbol	Item	Conditions	Min.	Typ.	Max.	Unit
V _{IN}	Operating Input Voltage		2.2		5.5	V
V _{FB}	V _{FB} Voltage Tolerance	V _{IN} =3.3V	0.985	1.000	1.015	V
ΔV _{FB} /ΔV _{IN}	V _{FB} Voltage Line Regulation	V _{IN} : from 2.2V to 5.5V		3		mV
ΔV _{FB} /ΔT _{opt}	V _{FB} Voltage Temperature Coefficient	-40°C ≤ T _{opt} ≤ 85°C		±150		ppm/°C
I _{FB}	V _{FB} Input Current	V _{IN} =5.5V, V _{FB} =0V or 5.5V	-0.1		0.1	μA
A _v	Open Loop Voltage Gain	V _{IN} =3.3V		100		dB
f _t	Unity Gain Frequency Band	V _{IN} =3.3V, A _v =0		1.0		MHz
f _{osc}	Oscillator Frequency	V _{IN} =3.3V, V _{DLY} =V _{FB} =0V	240	300	360	KHz
Δf _{osc} /ΔV _{IN}	Oscillator Frequency Line Regulation	V _{IN} : from 2.2V to 5.5V		25		KHz
Δf _{osc} /ΔT _{opt}	Oscillator Frequency Temperature Coefficient	-40°C ≤ T _{opt} ≤ 85°C		±0.5		KHz/°C
I _{DD1}	Supply Current 1	V _{IN} =5.5V, V _{DLY} =V _{FB} =0V EXT at no load		400	800	μA
V _{REFOUT}	V _{REFOUT} Voltage	V _{IN} =3.3V, I _{ROUT} =1mA	1.478	1.500	1.522	V
I _{OUT}	V _{REFOUT} Maximum Output Current	V _{IN} =3.3V	10			mA
ΔV _{REFOUT} /ΔV _{IN}	V _{REFOUT} Line Regulation	V _{IN} : from 2.2V to 5.5V		5	10	mV
ΔV _{REFOUT} /ΔI _{ROUT}	V _{REFOUT} Load Regulation	V _{IN} =3.3V, I _{ROUT} : from 0.1mA to 5.0mA		6	15	mV
I _{lim}	V _{REFOUT} Short Current Limit	V _{IN} =3.3V, V _{REFOUT} =0V		20		mA
ΔV _{REFOUT} /ΔT _{opt}	V _{REFOUT} Voltage Temperature Coefficient	-40°C ≤ T _{opt} ≤ 85°C		±150		ppm/°C
R _{EXTH}	EXT "H" ON Resistance	V _{IN} =3.3V, I _{EXT} =-50mA		2.5	6.0	Ω
R _{EXTL}	EXT "L" ON Resistance	V _{IN} =3.3V, I _{EXT} =50mA		1.5	4.0	Ω
t _r	EXT Rising Time	V _{IN} =3.3V, C _L =1000pF		12		ns
t _f	EXT Falling Time	V _{IN} =3.3V, C _L =1000pF		8		ns
I _{DLY1}	DELAY Pin Charge Current	V _{IN} =3.3V, V _{DLY} =V _{FB} =0V	2.0	4.5	7.0	μA
I _{DLY2}	DELAY Pin Discharge Current	V _{IN} =V _{FB} =2.2V, V _{DLY} =0.1V	0.08	0.20	0.36	mA
V _{DLY}	DELAY Pin Detector Threshold	V _{IN} =3.3V, V _{FB} =0V, V _{DLY} =0V to 2V	0.95	1.00	1.05	V
V _{UVLO1}	UVLO Detector Threshold	V _{IN} =3.3V to 0V, V _{DLY} =V _{FB} =0V	2.0	2.1	2.2	V
V _{UVLO2}	UVLO Released Voltage	V _{IN} =0V to 3.3V, V _{DLY} =V _{FB} =0V		V _{UVLO1} +0.2	2.45	V
V _{DTC0}	Duty=0% DTC Pin Voltage	V _{IN} =3.3V	0.05	0.18	0.25	V
V _{DTC20}	Duty=20% DTC Pin Voltage	V _{IN} =3.3V		0.3		V
V _{DTC80}	Duty=80% DTC Pin Voltage	V _{IN} =3.3V		0.75		V
Maxduty	Maximum Duty Cycle	V _{IN} =3.3V	85.5	91.5	97.5	%
I _{AMPH}	AMP "H" Output Current	V _{IN} =3.3V, V _{AMP} =1.0V, V _{FB} =0.9V	0.5	1.0	1.8	mA
I _{AMPL}	AMP "L" Output Current	V _{IN} =3.3V, V _{AMP} =1.0V, V _{FB} =1.1V	50	90	150	μA

R1212D

• R1212D102A

T_{opt}=25°C

Symbol	Item	Conditions	Min.	Typ.	Max.	Unit
V _{IN}	Operating Input Voltage		3.3		5.5	V
V _{FB}	V _{FB} Voltage Tolerance	V _{IN} =3.3V	0.985	1.000	1.015	V
ΔV _{FB} /ΔV _{IN}	V _{FB} Voltage Line Regulation	V _{IN} : from 2.2V to 5.5V		3		mV
ΔV _{FB} /ΔT _{opt}	V _{FB} Voltage Temperature Coefficient	-40°C ≤ T _{opt} ≤ 85°C		±150		ppm/°C
I _{FB}	V _{FB} Input Current	V _{IN} =5.5V, V _{FB} =0V or 5.5V	-0.1		0.1	μA
A _v	Open Loop Voltage Gain	V _{IN} =3.3V		100		dB
f _t	Unity Gain Frequency Band	V _{IN} =3.3V, A _v =0		1.0		MHz
f _{osc}	Oscillator Frequency	V _{IN} =3.3V, V _{DLY} =V _{FB} =0V	595	700	805	KHz
Δf _{osc} /ΔV _{IN}	Oscillator Frequency Line Regulation	V _{IN} : from 2.2V to 5.5V		50		KHz
Δf _{osc} /ΔT _{opt}	Oscillator Frequency Temperature Coefficient	-40°C ≤ T _{opt} ≤ 85°C		±1.0		KHz/°C
I _{DD1}	Supply Current 1	V _{IN} =5.5V, V _{DLY} =V _{FB} =0V EXT at no load		600	1000	μA
V _{REFOUT}	V _{REFOUT} Voltage	V _{IN} =3.3V, I _{ROUT} =1mA	1.478	1.500	1.522	V
I _{OUT}	V _{REFOUT} Maximum Output Current	V _{IN} =3.3V	10			mA
ΔV _{REFOUT} /ΔV _{IN}	V _{REFOUT} Line Regulation	V _{IN} : from 2.2V to 5.5V		5	10	mV
ΔV _{REFOUT} /ΔI _{ROUT}	V _{REFOUT} Load Regulation	V _{IN} =3.3V, I _{ROUT} : from 0.1mA to 5.0mA		6	15	mV
I _{lim}	V _{REFOUT} Short Current Limit	V _{IN} =3.3V, V _{REFOUT} =0V		20		mA
ΔV _{REFOUT} /ΔT _{opt}	V _{REFOUT} Voltage Temperature Coefficient	-40°C ≤ T _{opt} ≤ 85°C		±150		ppm/°C
R _{EXTH}	EXT "H" ON Resistance	V _{IN} =3.3V, I _{EXT} =-50mA		2.5	6.0	Ω
R _{EXTL}	EXT "L" ON Resistance	V _{IN} =3.3V, I _{EXT} =50mA		1.5	4.0	Ω
t _r	EXT Rising Time	V _{IN} =3.3V, C _L =1000pF		12		ns
t _f	EXT Falling Time	V _{IN} =3.3V, C _L =1000pF		8		ns
I _{DLY1}	DELAY Pin Charge Current	V _{IN} =3.3V, V _{DLY} =V _{FB} =0V	3.0	5.5	8.0	μA
I _{DLY2}	DELAY Pin Discharge Current	V _{IN} =V _{FB} =2.2V, V _{DLY} =0.1V	0.08	0.20	0.36	mA
V _{DLY}	DELAY Pin Detector Threshold	V _{IN} =3.3V, V _{FB} =0V, V _{DLY} =0V to 2V	0.95	1.00	1.05	V
V _{UVLO1}	UVLO Detector Threshold	V _{IN} =3.3V to 0V, V _{DLY} =V _{FB} =0V	2.6	2.8	3.0	V
V _{UVLO2}	UVLO Released Voltage	V _{IN} =0V to 3.3V, V _{DLY} =V _{FB} =0V		V _{UVLO1} + 0.25	3.3	V
V _{DTC0}	Duty=0% DTC Pin Voltage	V _{IN} =3.3V	0.05	0.18	0.25	V
V _{DTC20}	Duty=20% DTC Pin Voltage	V _{IN} =3.3V		0.3		V
V _{DTC80}	Duty=80% DTC Pin Voltage	V _{IN} =3.3V		0.75		V
Maxduty	Maximum Duty Cycle	V _{IN} =3.3V	84	90	96	%
I _{AMPH}	AMP "H" Output Current	V _{IN} =3.3V, V _{AMP} =1.0V, V _{FB} =0.9V	0.5	1.0	1.8	mA
I _{AMPL}	AMP "L" Output Current	V _{IN} =3.3V, V _{AMP} =1.0V, V _{FB} =1.1V	60	100	160	μA

• R1212D102C

T_{opt}=25°C

Symbol	Item	Conditions	Min.	Typ.	Max.	Unit
V _{IN}	Operating Input Voltage		3.3		5.5	V
V _{FB}	V _{FB} Voltage Tolerance	V _{IN} =3.3V	0.985	1.000	1.015	V
ΔV _{FB} /ΔV _{IN}	V _{FB} Voltage Line Regulation	V _{IN} : from 2.2V to 5.5V		3		mV
ΔV _{FB} /ΔT _{opt}	V _{FB} Voltage Temperature Coefficient	-40°C ≤ T _{opt} ≤ 85°C		±150		ppm/°C
I _{FB}	V _{FB} Input Current	V _{IN} =5.5V, V _{FB} =0V or 5.5V	-0.1		0.1	μA
A _v	Open Loop Voltage Gain	V _{IN} =3.3V		100		dB
f _t	Unity Gain Frequency Band	V _{IN} =3.3V, A _v =0		1.0		MHz
f _{osc}	Oscillator Frequency	V _{IN} =3.3V, V _{DLY} =V _{FB} =0V	240	300	360	KHz
Δf _{osc} /ΔV _{IN}	Oscillator Frequency Line Regulation	V _{IN} : from 2.2V to 5.5V		25		KHz
Δf _{osc} /ΔT _{opt}	Oscillator Frequency Temperature Coefficient	-40°C ≤ T _{opt} ≤ 85°C		±0.5		KHz/°C
I _{DD1}	Supply Current 1	V _{IN} =5.5V, V _{DLY} =V _{FB} =0V EXT at no load		400	800	μA
V _{REFOUT}	V _{REFOUT} Voltage	V _{IN} =3.3V, I _{ROUT} =1mA	1.478	1.500	1.522	V
I _{OUT}	V _{REFOUT} Maximum Output Current	V _{IN} =3.3V	10			mA
ΔV _{REFOUT} /ΔV _{IN}	V _{REFOUT} Line Regulation	V _{IN} : from 2.2V to 5.5V		5	10	mV
ΔV _{REFOUT} /ΔI _{ROUT}	V _{REFOUT} Load Regulation	V _{IN} =3.3V, I _{ROUT} : from 0.1mA to 5.0mA		6	15	mV
I _{lim}	V _{REFOUT} Short Current Limit	V _{IN} =3.3V, V _{REFOUT} =0V		20		mA
ΔV _{REFOUT} /ΔT _{opt}	V _{REFOUT} Voltage Temperature Coefficient	-40°C ≤ T _{opt} ≤ 85°C		±150		ppm/°C
R _{EXTH}	EXT "H" ON Resistance	V _{IN} =3.3V, I _{EXT} =-50mA		2.5	6.0	Ω
R _{EXTL}	EXT "L" ON Resistance	V _{IN} =3.3V, I _{EXT} =50mA		1.5	4.0	Ω
t _r	EXT Rising Time	V _{IN} =3.3V, C _L =1000pF		12		ns
t _f	EXT Falling Time	V _{IN} =3.3V, C _L =1000pF		8		ns
I _{DLY1}	DELAY Pin Charge Current	V _{IN} =3.3V, V _{DLY} =V _{FB} =0V	2.0	4.5	7.0	μA
I _{DLY2}	DELAY Pin Discharge Current	V _{IN} =V _{FB} =2.2V, V _{DLY} =0.1V	0.08	0.20	0.36	mA
V _{DLY}	DELAY Pin Detector Threshold	V _{IN} =3.3V, V _{FB} =0V, V _{DLY} =0V to 2V	0.95	1.00	1.05	V
V _{UVLO1}	UVLO Detector Threshold	V _{IN} =3.3V to 0V, V _{DLY} =V _{FB} =0V	2.6	2.8	3.0	V
V _{UVLO2}	UVLO Released Voltage	V _{IN} =0V to 3.3V, V _{DLY} =V _{FB} =0V		V _{UVLO1} + 0.25	3.30	V
V _{DTC0}	Duty=0% DTC Pin Voltage	V _{IN} =3.3V	0.05	0.18	0.25	V
V _{DTC20}	Duty=20% DTC Pin Voltage	V _{IN} =3.3V		0.3		V
V _{DTC80}	Duty=80% DTC Pin Voltage	V _{IN} =3.3V		0.75		V
Maxduty	Maximum Duty Cycle	V _{IN} =3.3V	85.5	91.5	97.5	%
I _{AMPH}	AMP "H" Output Current	V _{IN} =3.3V, V _{AMP} =1.0V, V _{FB} =0.9V	0.5	1.0	1.8	mA
I _{AMPL}	AMP "L" Output Current	V _{IN} =3.3V, V _{AMP} =1.0V, V _{FB} =1.1V	50	90	150	μA

TYPICAL APPLICATIONS AND TECHNICAL NOTES

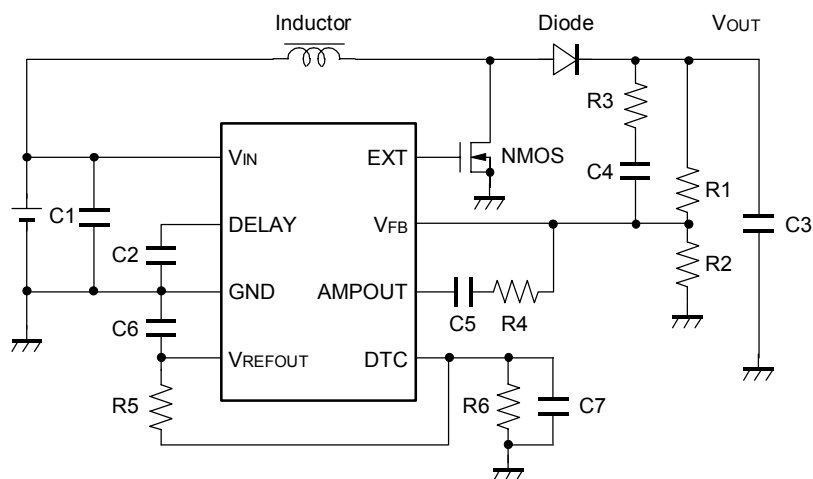

Inductor	LDR655312T-100(TDK) [R1212DxxxA]				
	LDR655312T-4R7(TDK) [R1212DxxxB]				
	LDR655312T-220(TDK) [R1212DxxxC]				
NMOS	CPH6415 (Sanyo)				
Diode	CRS02 (Toshiba)				
C1	2.2 μ F	C6	0.1 μ F		
C2	1 μ F	C7	0.1 μ F		
C3	1.5 μ F	Set V	5V	10V	15V
C4	1000pF[R1212DxxxA]	R1	120k Ω	180k Ω	140k Ω
	680pF[R1212DxxxB]	R2	30k Ω	20k Ω	10k Ω
	1500pF[R1212DxxxC]	R3	1k Ω		
C5	1000pF[R1212DxxxA]	R4	4.7k Ω		
	680pF[R1212DxxxB]	R5	240k Ω		
	1500pF[R1212DxxxC]	R6	300k Ω		

Use a 1 μ F or more capacitance value of bypass capacitor between V_{IN} pin and GND, C1 as shown in the typical application above. Connect the capacitor as short as possible to the IC.

- In terms of the capacitor for setting delay time of the latch protection, C2 is shown in typical application above. Latch delay time depends on this C2 value. Refer to the Latch Protection Operation Timing Chart.
- Connect a 1 μ F or more value of capacitor between V_{OUT} and GND, C3 as shown in typical application above. (Recommended value is from 10 μ F to 22 μ F.) If the operation of the composed DC/DC converter may be unstable, use a tantalum type capacitor instead of ceramic type
- Connect a capacitor between V_{REFOUT} and GND, C6 as shown in typical application of the previous page. The capacitance value of C6 is between 0.1 μ F and 1.0 μ F.

• Output Voltage Setting Method and Phase Compensation Making Method

- The feedback voltage is controlled into 1.0V. The output voltage can be set with divider resistors for voltage setting, R1 and R2 as shown in typical application of the previous page. Refer to the next formula.

$$\text{Output Voltage} = V_{FB} \times (R1+R2)/R2$$

Output Voltage is adjustable with setting various resistor values combination.

R1+R2 should be equal or less than 500kΩ

As for the DC/DC converter, depending on the load current and external components such as L and C, phase may loss around 180°. In such case, phase margin becomes less and may be unstable. To avoid this situation, make the phase margin more. The pole is made with external components L and C.

$$F_{\text{pole}} \sim 1 / \{ 2 \times \pi \times \sqrt{L \times C3} \}$$

C4, C5, R3, and R4 shown in the diagram are for making phase compensation. The gain of the system can be set with using these resistors and capacitors. Each value in the diagram is just an example.

R4 and C5 make zero (the backward phase).

$$F_{\text{zero}} \sim 1 / (2 \times \pi \times R4 \times C5)$$

Choose the R4 and C5 value so as to make the cutoff frequency of this zero point close to the cutoff frequency of the pole by external components, L and C.

For example, supposed that L=10μH and C_{OUT} (C3) =10μF, the cutoff frequency of the pole is approximately 16kHz. Therefore make the cutoff frequency of the zero point close to 16kHz. Then R4=4.7kΩ and C5=1000pF are appropriate values.

As for setting the gain, the ratio of the composite resistor (RT: RT=R1×R2/(R1+R2)) to R4 is the key.

If the R4 against the composite resistor, R_T, is large, the gain becomes also large. If the gain is large, the response characteristic is improved, however, too large gain makes the system be unstable.

If the spike noise of V_{OUT} may be large, the spike noise may be picked into V_{FB} pin, and the unstable operation may result. In this case, a resistor R3, shown in typical application of the previous page. The recommended resistance value of R3 is in the range from 1kΩ to 5kΩ. Then, noise level will be decreased.

Further, R1 and C4 makes another zero point (the backward phase).

$$F_{\text{zero}} \sim 1 / (2 \times \pi \times R1 \times C4)$$

Make the cutoff frequency of this zero point be lower than the cutoff frequency of the pole by external components, or, L and C. Herein, R1=180kΩ and C4=1000pF are appropriate values.

- Select the Power MOSFET, the diode, capacitors and the inductor within ratings (Voltage, Current, Power) of this IC. Choose the power MOSFET with low threshold voltage depending on the input voltage to be able to turn on the FET completely. Choose the diode with low V_F such as Schottky type with low reverse current I_R, and with fast switching speed. When an external transistor is switching, spike voltage may be generated caused by an inductor, therefore recommended voltage tolerance of capacitor connected to V_{OUT} is twice as much as the setting voltage or more.
- The soft-start time and the maximum duty cycle setting method
The soft-start time and the maximum duty cycle can be set with R5, R6, and C7 values connected to the V_{REFOUT} pin and the DTC pin. (Refer to the timing chart: Soft-start operation.)

Output Current and Selection of External Components

<Basic Circuit>

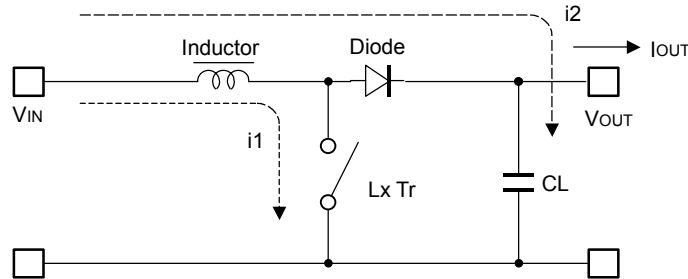

<Circuit through L>

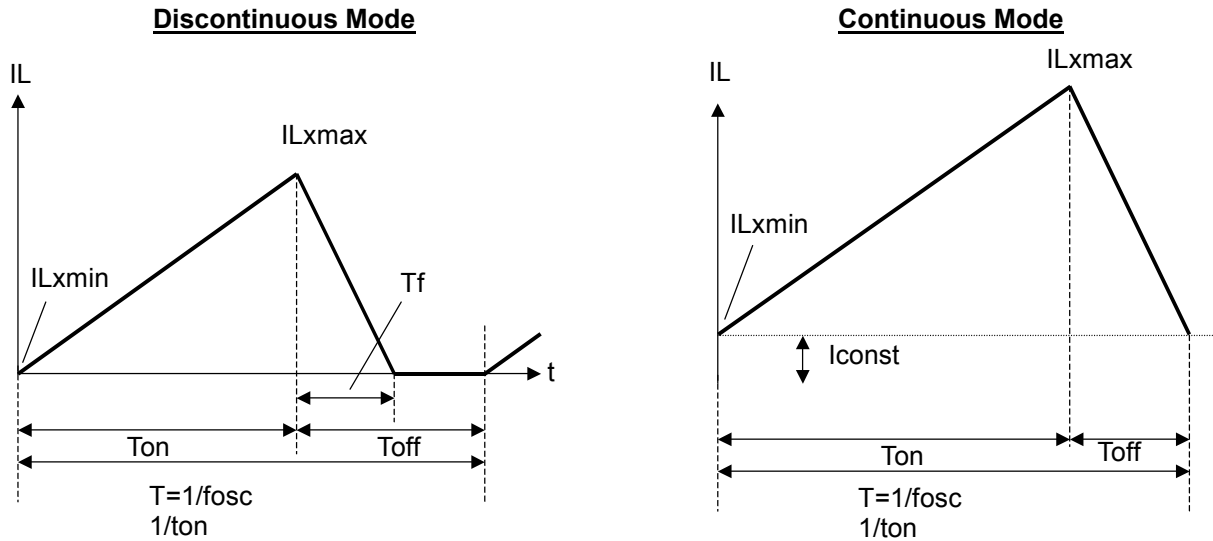

There are two modes, or discontinuous mode and continuous mode for the PWM step-up switching regulator depending on the continuous characteristic of inductor current.

During on time of the transistor, when the voltage added on to the inductor is described as V_{IN} , the current is $V_{IN} \times t/L$. Therefore, the electric power, P_{ON} , which is supplied with input side, can be described as in next formula.

$$P_{ON} = \int_0^{T_{on}} V_{IN}^2 \times t/L \, dt \dots\dots\dots \text{Formula 1}$$

With the step-up circuit, electric power is supplied from power source also during off time. In this case, input current is described as $(V_{OUT} - V_{IN}) \times t/L$, therefore electric power, P_{OFF} is described as in next formula.

$$P_{OFF} = \int_0^{T_f} V_{IN} \times (V_{OUT} - V_{IN}) \times t/L \, dt \dots\dots\dots \text{Formula 2}$$

In this formula, T_f means the time of which the energy saved in the inductance is being emitted. Thus average electric power, or P_{AV} is described as in the next formula.

$$P_{AV} = 1/(T_{ON} + T_{OFF}) \times \left\{ \int_0^{T_{on}} V_{IN}^2 \times t/L \, dt + \int_0^{T_f} V_{IN} \times (V_{OUT} - V_{IN}) \times t/L \, dt \right\} \dots\dots\dots \text{Formula 3}$$

In PWM control, when $T_f = T_{off}$ is true, the inductor current becomes continuous, then the operation of switching regulator becomes continuous mode.

In the continuous mode, the deviation of the current is equal between on time and off time.

$$V_{IN} = T_{ON}/L = (V_{OUT} - V_{IN}) \times T_{OFF} / L \dots\dots\dots \text{Formula 4}$$

Further, the electric power, P_{AV} is equal to output electric power, $V_{OUT} \times I_{OUT}$, thus,

$$I_{OUT} = f_{OSC} \times V_{IN}^2 \times T_{ON}^2 / \{2 \times L \times (V_{OUT} - V_{IN})\} = V_{IN}^2 \times T_{ON} / (2 \times L \times V_{OUT}) \dots\dots\dots \text{Formula 5}$$

When I_{OUT} becomes more than formula 5, the current flows through the inductor, then the mode becomes continuous. The continuous current through the inductor is described as I_{CONST} , then,

$$I_{OUT} = f_{OSC} \times V_{IN}^2 \times T_{ON}^2 / \{2 \times L \times (V_{OUT} - V_{IN})\} + V_{IN} \times I_{CONST} / V_{OUT} \dots\dots\dots \text{Formula 6}$$

In this moment, the peak current, I_{LXMAX} flowing through the inductor and the driver T_r is described as follows:

$$I_{LXMAX} = I_{CONST} + V_{IN} \times T_{ON} / L \dots\dots\dots \text{Formula 7}$$

With the formula 4,6, and I_{LXMAX} is,

$$I_{LXMAX} = V_{OUT} / V_{IN} \times I_{OUT} + V_{IN} \times T_{ON} / (2 \times L) \dots\dots\dots \text{Formula 8}$$

Therefore, peak current is more than I_{OUT} . Considering the value of I_{LXMAX} , the condition of input and output, and external components should be selected.

In the formula 7, peak current I_{LXMAX} at discontinuous mode can be calculated. Put $I_{CONST}=0$ in the formula.

The explanation above is based on the ideal calculation, and the loss caused by L_x switch and external components is not included. The actual maximum output current is between 50% and 80% of the calculation. Especially, when the I_{LX} is large, or V_{IN} is low, the loss of V_{IN} is generated with the on resistance of the switch. As for V_{OUT} , V_f (as much as 0.3V) of the diode should be considered.

TIMING CHART

<Soft-start Operation>

The timing chart below describes the state of each pin from the power-on until the IC entering the stable operation.

By raising the voltage of the DTC pin slowly, the switching duty cycle is limited, and prevent the drastic voltage rising (over-shoot) and inrush current.

When the V_{IN} voltage becomes equal or more than the UVLO released voltage ($V_{UVLO}+V_{HYS}$), V_{REFOUT} operation starts. Following with the increase of the voltage level of V_{REFOUT} , the internal oscillator begins to operate, then the DTC voltage is also rising, then, soft-start operation starts. When the DTC voltage crosses the chopping wave level inside the IC, EXT pin starts switching, then, step-up operation begins. During this term, the output voltage does not reach the set output voltage. Therefore the output of the amplifier is "H". Besides, the protection circuit may work and the IC charges the DELAY pin. Because of this, the soft-start time should be set shorter than the latch protection delay time.

After the initial stage, when the output voltage reaches the set output voltage, the level of AMPOUT becomes the normal state. In other words, the level is determined with the input voltage, the output voltage, and the output current. When the level of AMPOUT becomes falling, charging the DELAY pin stops and discharges to the GND. The soft-start time (the time for the DTC pin voltage becoming to V_{DTC} level) can be estimated with the next formula.

$$T \cong 1/\alpha \times \ln(V_{DTC} \times \alpha / \beta + 1), \text{ herein, } \alpha = -1/C7 \times (1/R5 + 1/R6), \text{ and } \beta = V_{REFOUT} / (C7 \times R5).$$

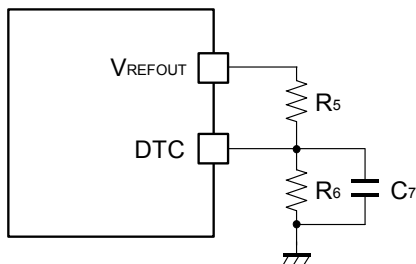
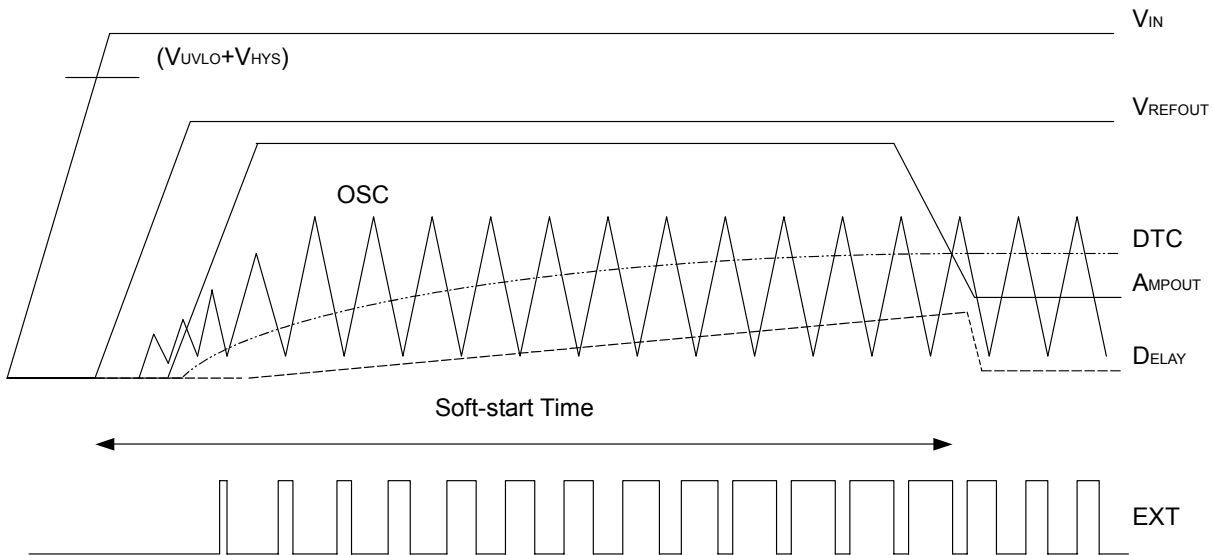

<Latch Protection Operation>

The operation of Latch protection circuit is as follows: When AMPOUT becomes "H" and the IC detects maximum duty cycle, charge to an external capacitor, C2 of DELAY pin starts. The maximum duty cycle continues and the voltage of DELAY pin reaches delay voltage detector threshold, V_{DLY}, outputs "L" to EXT pin and turns off the external power MOSFET.

To release the latch protection operation, make the supply voltage down to UVLO detector threshold or lower, and make it rise up to the normal input voltage.

Once after becoming the maximum duty cycle, if the duty cycle decreases before latch operation works, the charging the capacitor stops immediately, and the DELAY pin voltage is fixed at GND level with I_{DLY2}.

The delay time of latch protection can be calculated with C2, V_{DLY}, and the delay pin charge current, I_{DLY1}, as in the next formula.

$$t=C2 \times V_{DLY}/I_{DLY1}$$

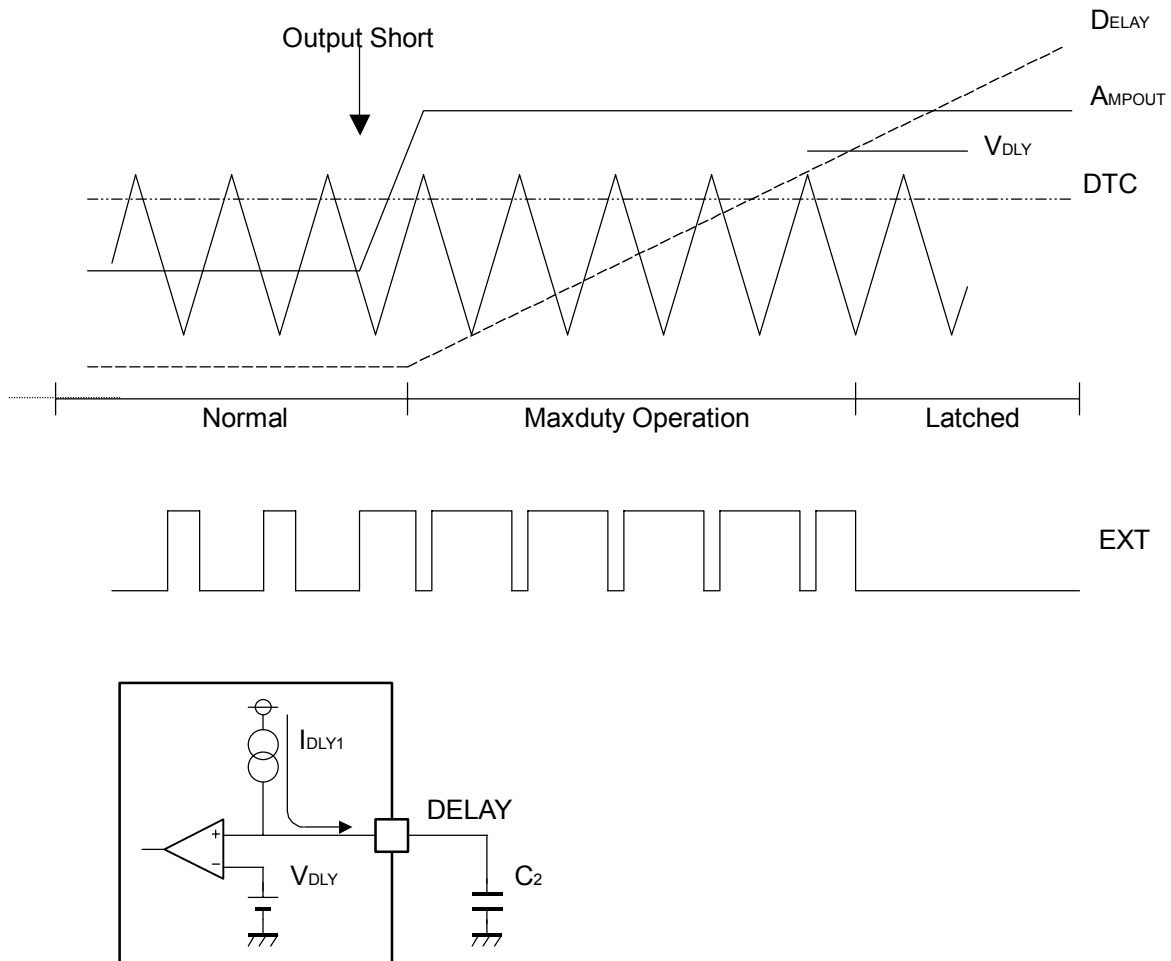

TEST CIRCUITS

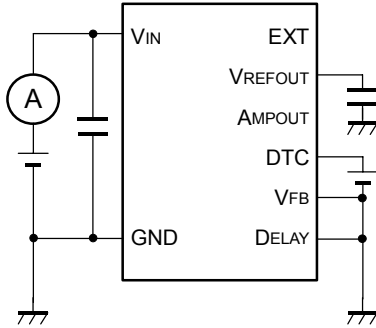

Fig.1 Consumption Current Test Circuit

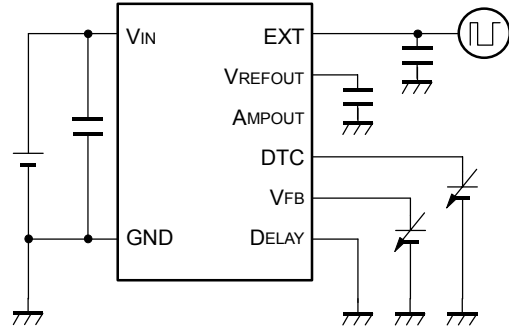

Fig.2 Oscillator Frequency, V_{FB} Voltage, Duty Cycle, EXT rising time/falling time Test Circuit

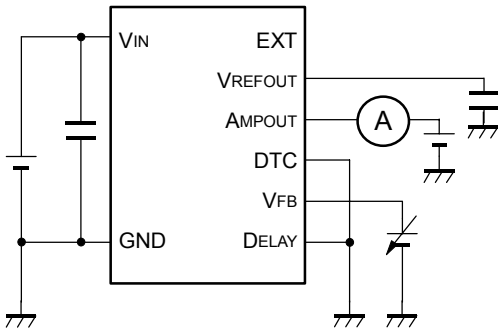

Fig.3 AMP "L" Output Current/ "H" Output Current Test Circuit

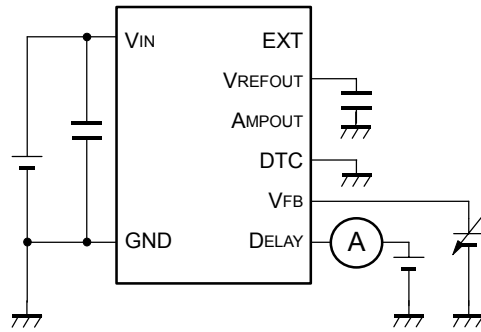

Fig.4 DELAY Pin Charge Current/ Discharge Current Test Circuit

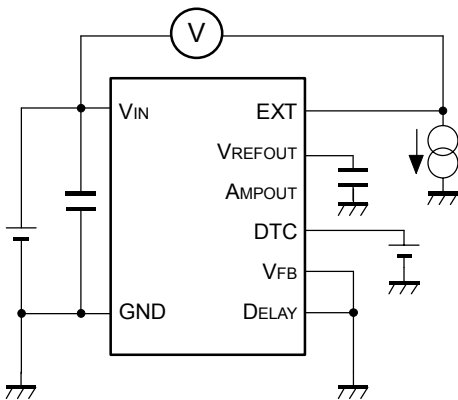

Fig.5 EXT "H" ON Resistance Test Circuit

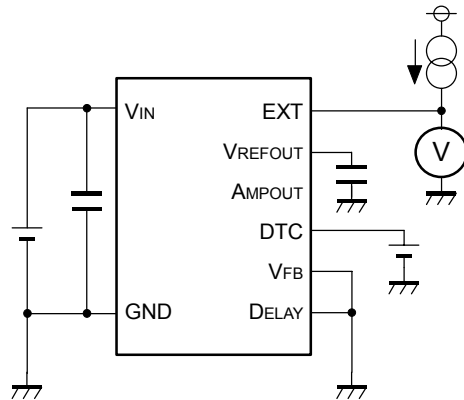

Fig.6 EXT "L" ON Resistance Test Circuit

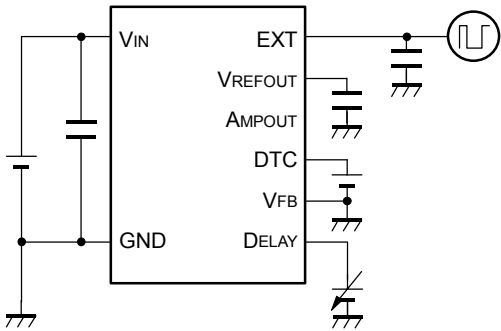

Fig. 7 DELAY Pin Detector Threshold Test Circuit

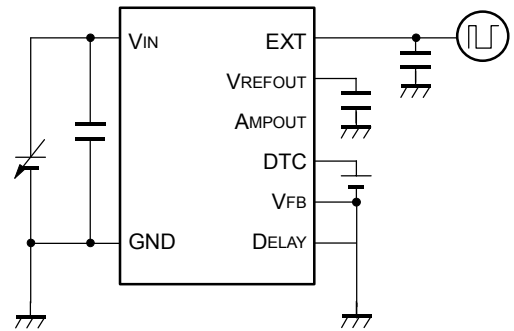

Fig. 8 UVLO Detector Threshold/Released Voltage Test Circuit

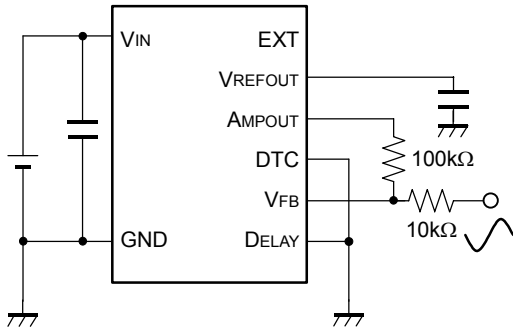

Fig. 9 Error AMP Gain/Phase Test Circuit

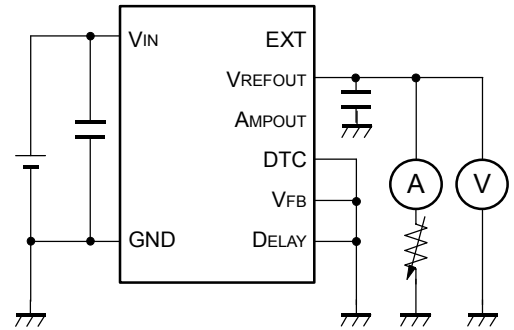

Fig. 10 VREFOUT Voltage Test Current

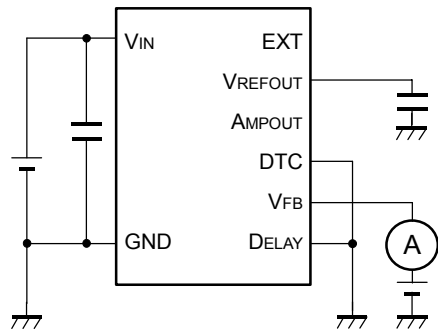

Fig. 11 VFB Leakage Current Test Circuit

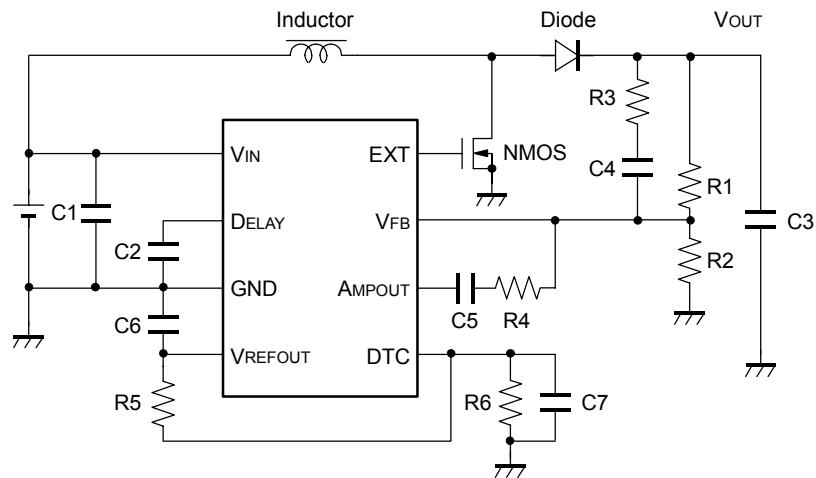
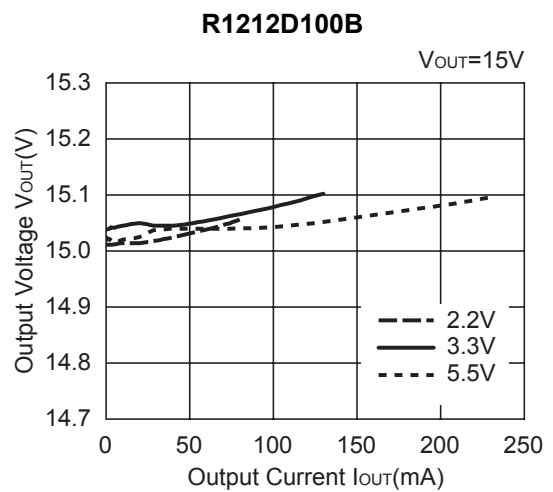
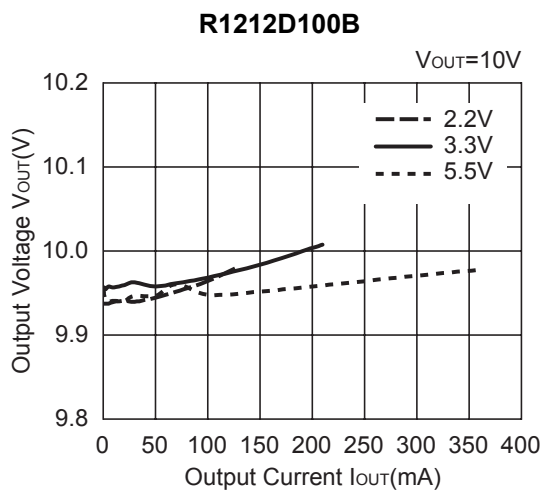
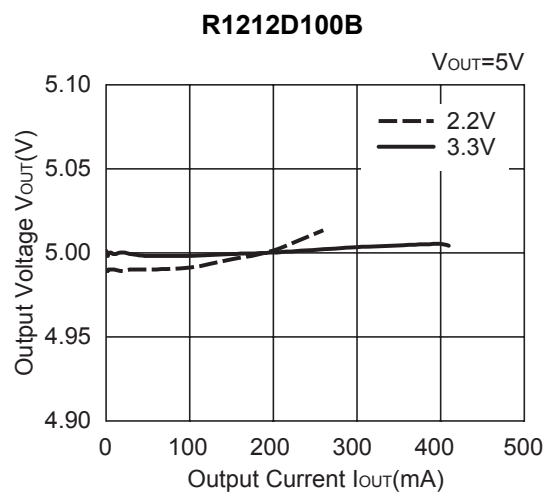
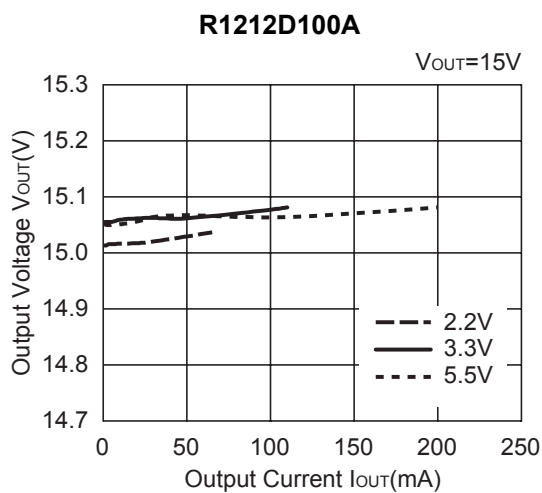
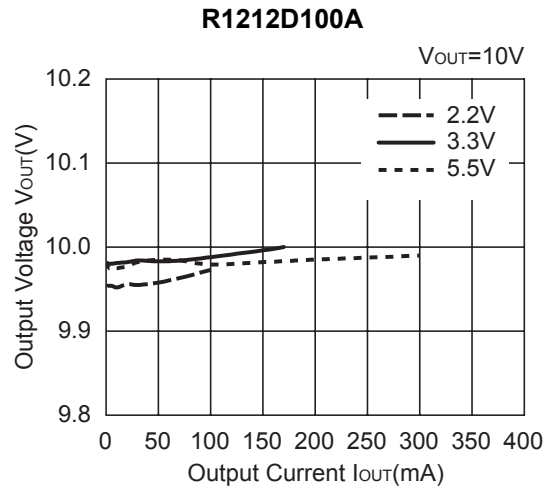
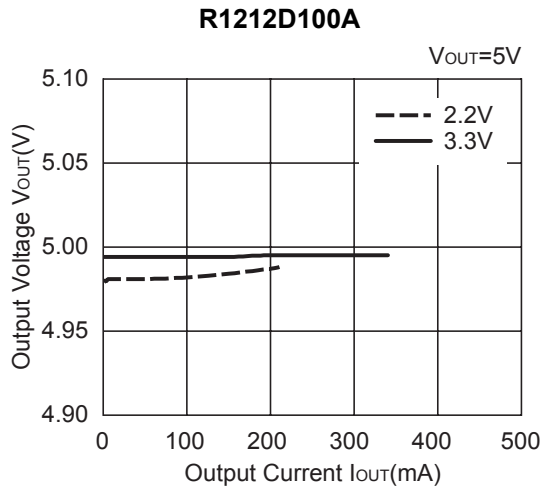

Fig.12 Output Current vs. Output Voltage/Efficiency, Response Characteristics Test Circuit

Inductor	LDR655312T-100(TDK) [R1212DxxxA]					
	LDR655312T-4R7(TDK) [R1212DxxxB]					
	LDR655312T-220(TDK) [R1212DxxxC]					
NMOS	CPH6415 (Sanyo)					
Diode	CRS02 (Toshiba)					
C1	2.2 μ F	C6	0.1 μ F			
C2	1 μ F	C7	0.1 μ F			
C3	15 μ F	SetV	5V	10V	15V	
C4	1000pF[R1212DxxxA]	R1	120k Ω	180k Ω	140k Ω	
	680pF[R1212DxxxB]	R2	30k Ω	20k Ω	10k Ω	
	1500pF[R1212DxxxC]	R3	1k Ω			
C5	1000pF[R1212DxxxA]	R4	4.7k Ω			
	680pF[R1212DxxxB]	R5	240k Ω			
	1500pF[R1212DxxxC]	R6	300k Ω			

TYPICAL CHARACTERISTICS

1) Output Voltage vs. Output Current (Topt=25°C)



R1212D101C

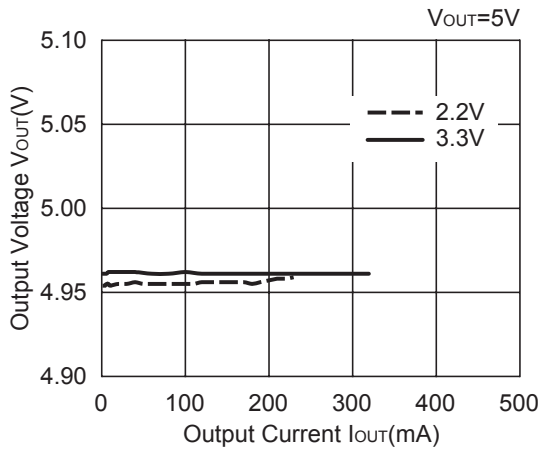

R1212D101C

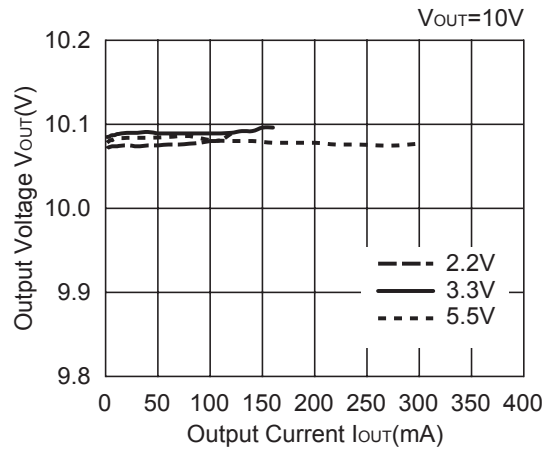

R1212D101C

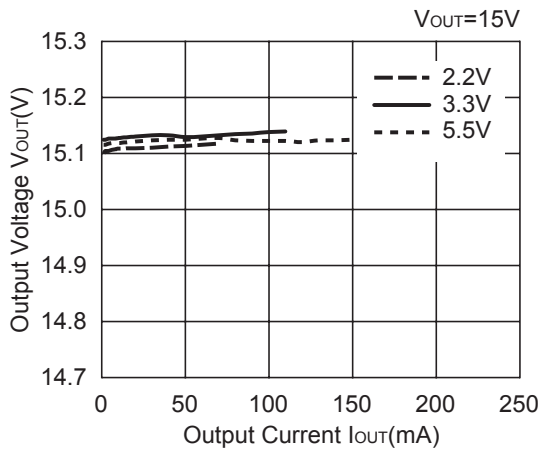

2) Efficiency vs. Output Current (T_{opt}=25°C)

R1212D100A

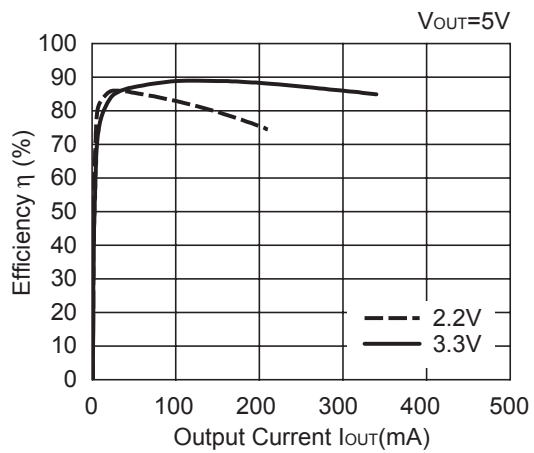

R1212D100A

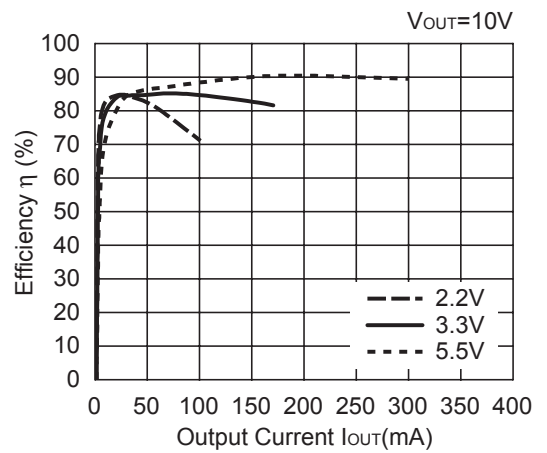

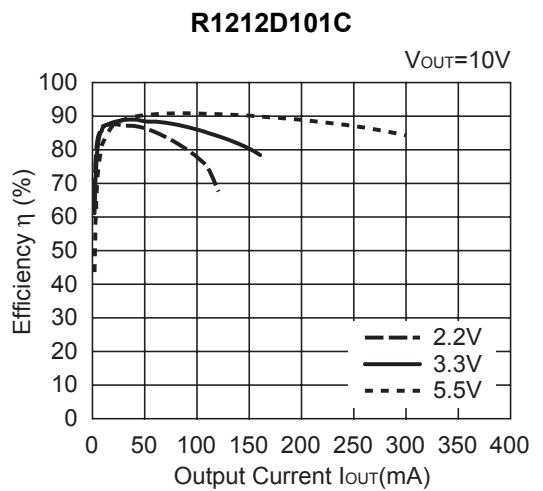
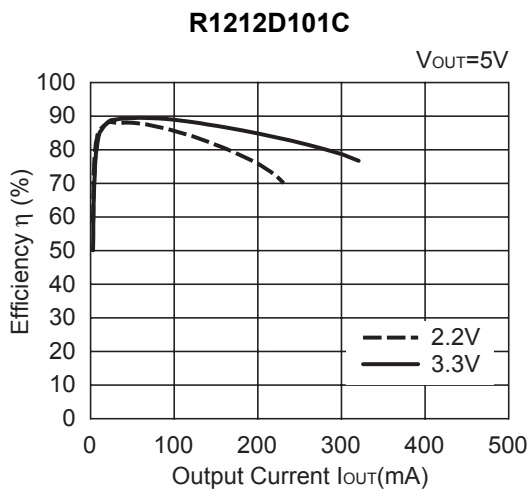
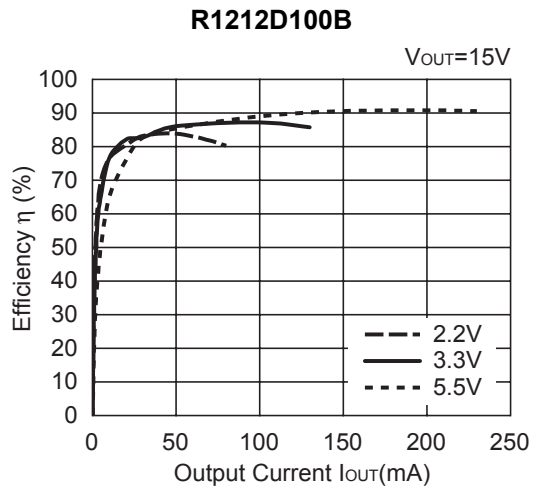
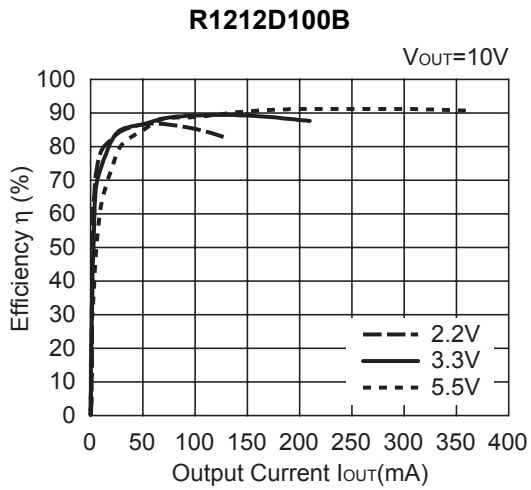
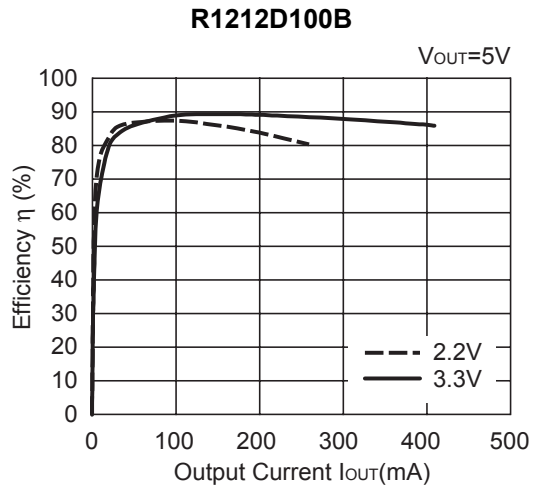
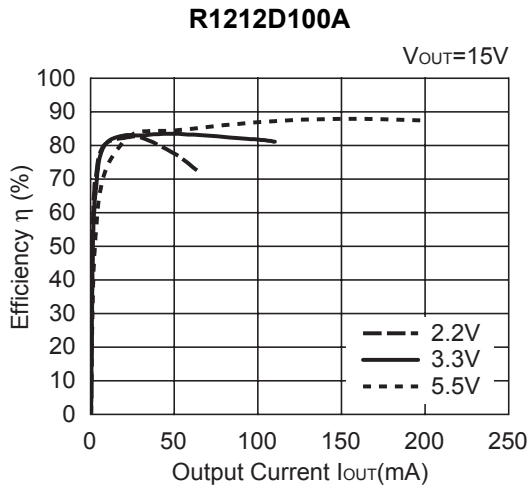

R1212D101C

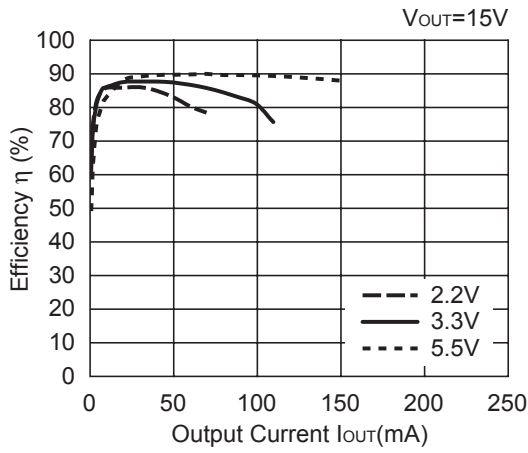

3) V_{FB} Voltage vs. Input Voltage ($T_{opt} = 25^{\circ}C$)

R1212D100x

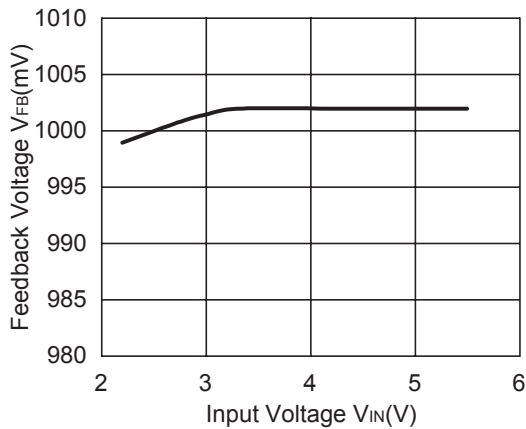

4) V_{FB} Voltage vs. Temperature

R1212D100x

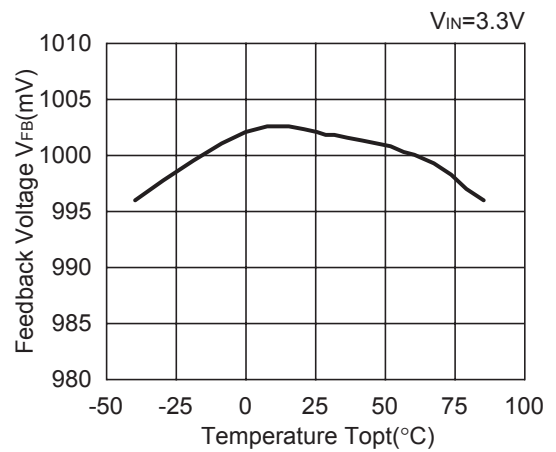

5) Oscillator Frequency vs. Input Voltage ($T_{opt}=25^{\circ}C$)

R1212D100A

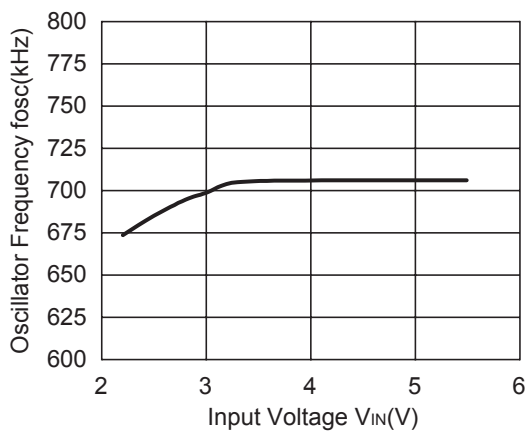

R1212D100B

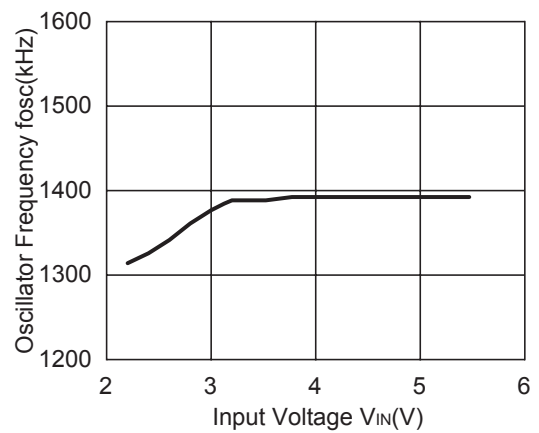

R1212D101C

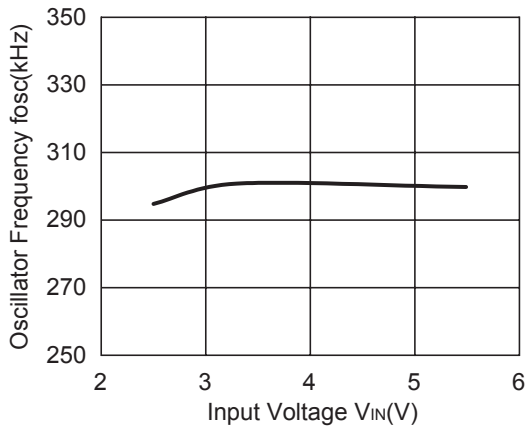

6) Oscillator Frequency vs. Temperature

R1212D10xA

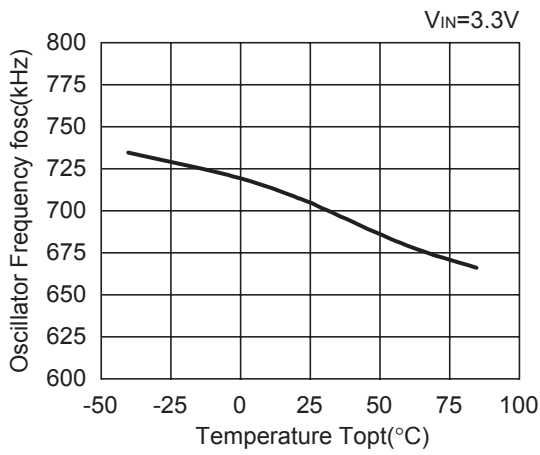

R1212D10xB

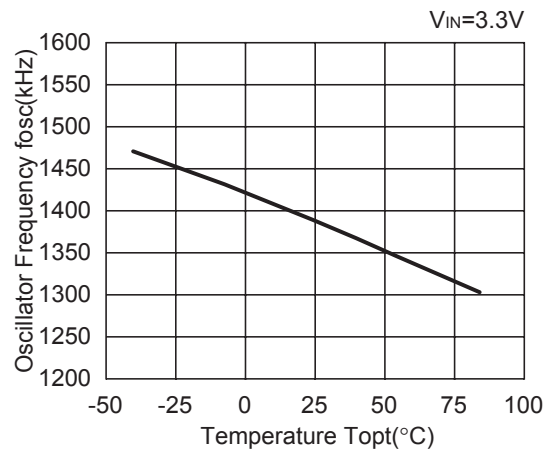

R1212D10xC

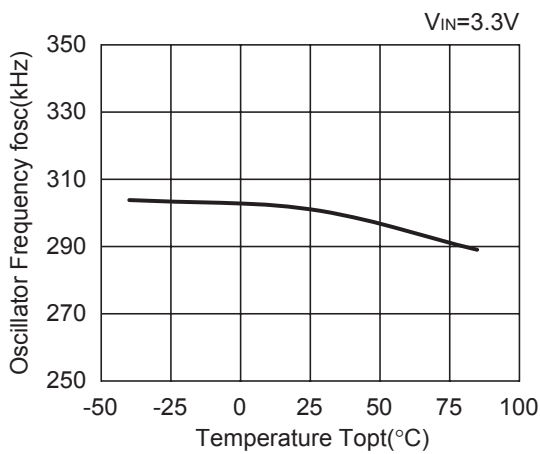

7) Supply Current vs. Input Voltage ($T_{opt} = -25^{\circ}\text{C}$ at no load)

R1212D100A

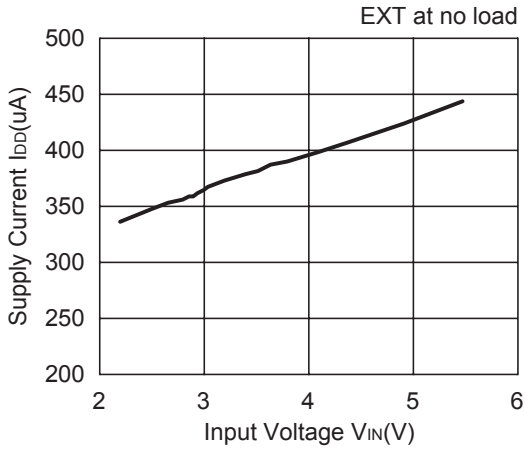

R1212D100B

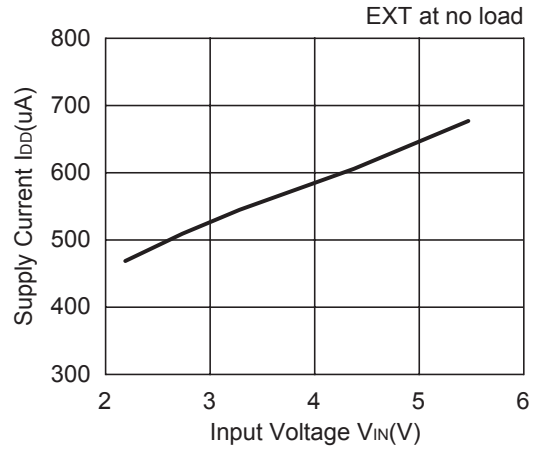

R1212D101C

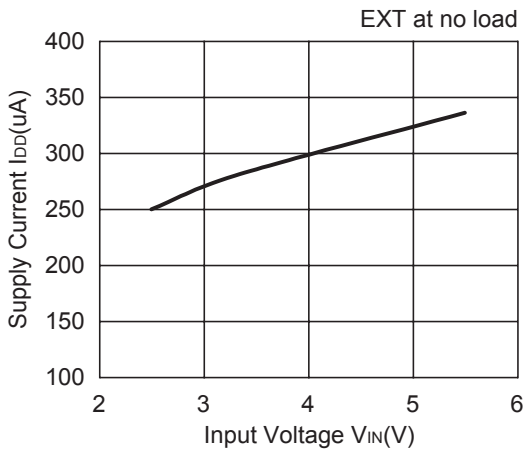

8) Supply Current vs. Temperature

R1212D10xA

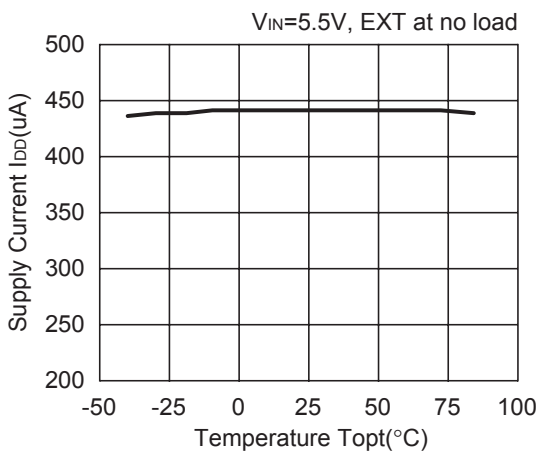

R1212D10xB

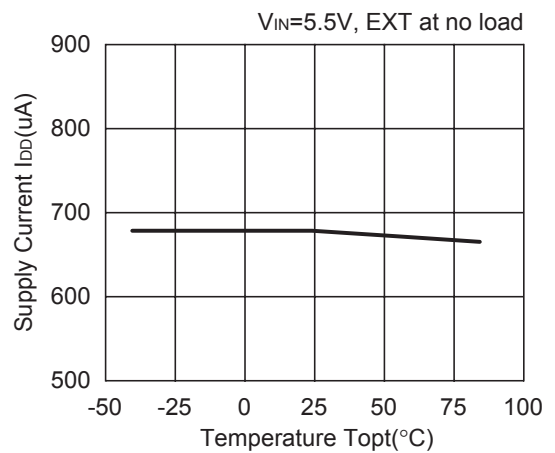

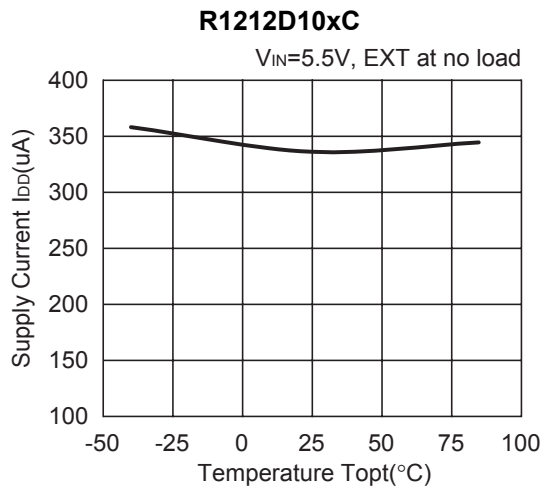

9) EXT "L" ON Resistance vs. Temperature

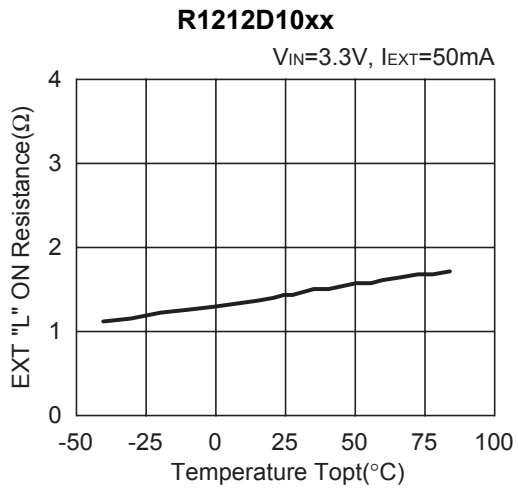

10) EXT "H" ON Resistance vs. Temperature

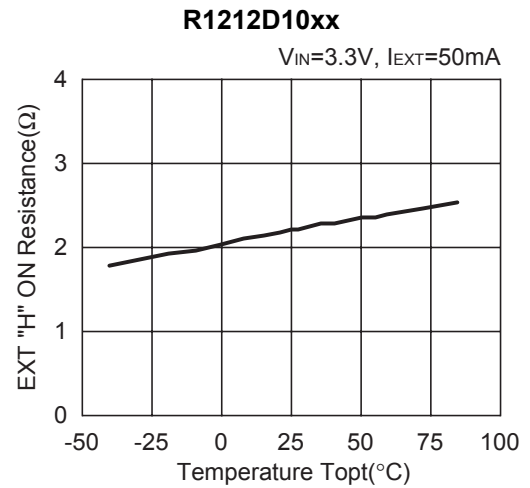

11) EXT Rising Time vs. Temperature

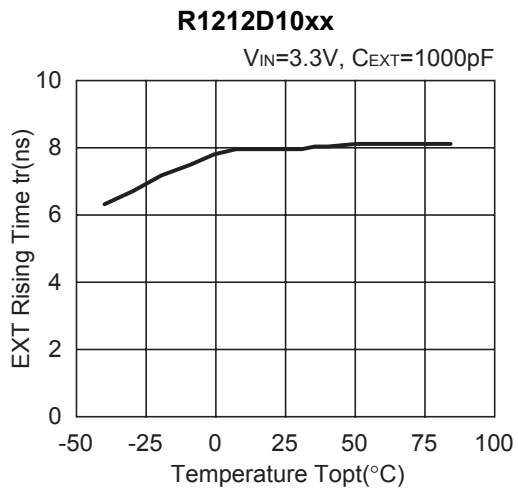

12) EXT Falling Time vs. Temperature

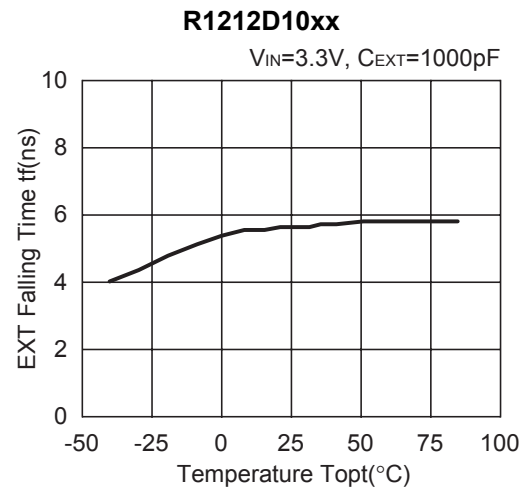

R1212D

13) Duty Cycle vs. DTC Voltage (0% to 100%) (Topt=25°C)

R1212D100A

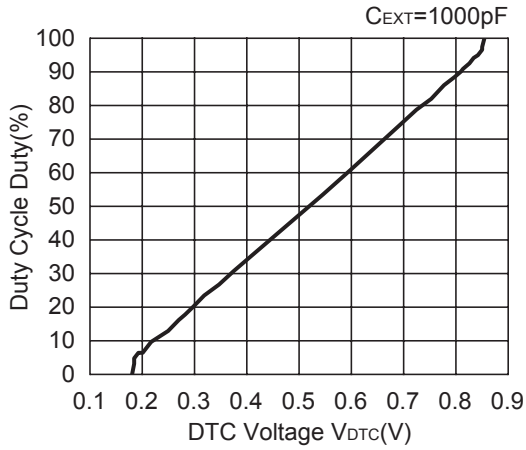

R1212D100B

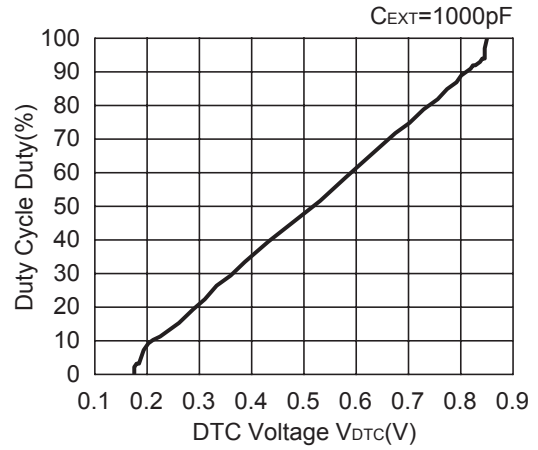

R1212D101A

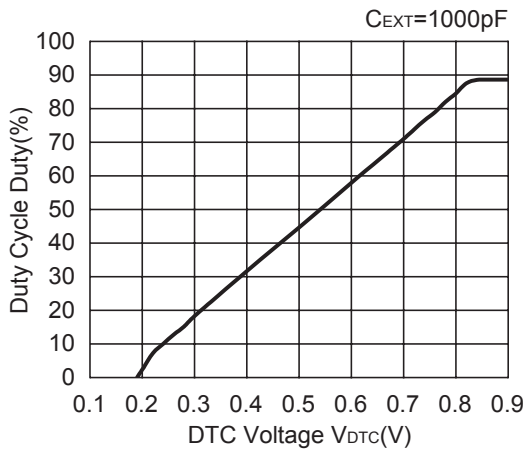

R1212D101C

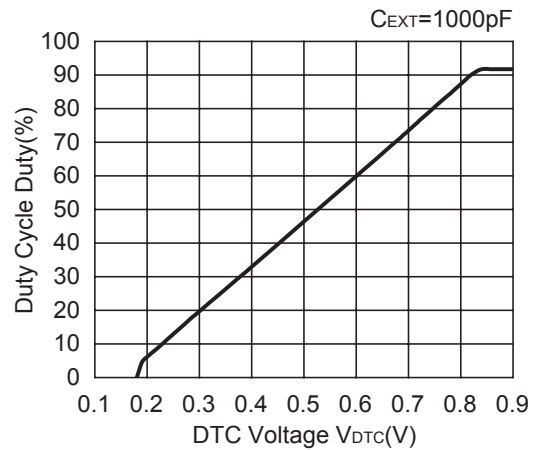

14) Duty Cycle vs. Temperature

R1212D100A

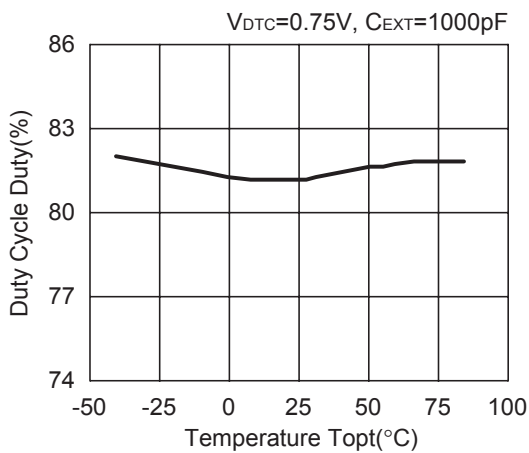

R1212D100B

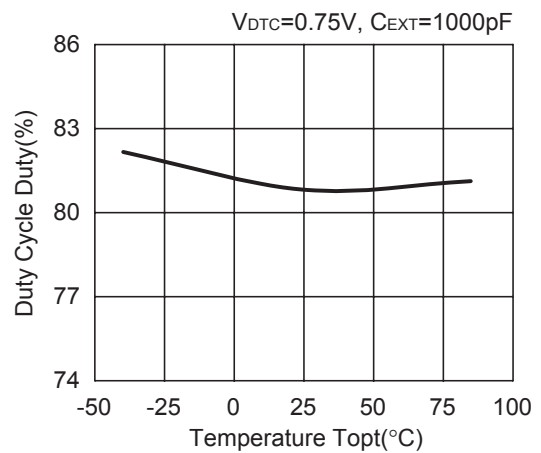

15) Maxduty vs. Temperature

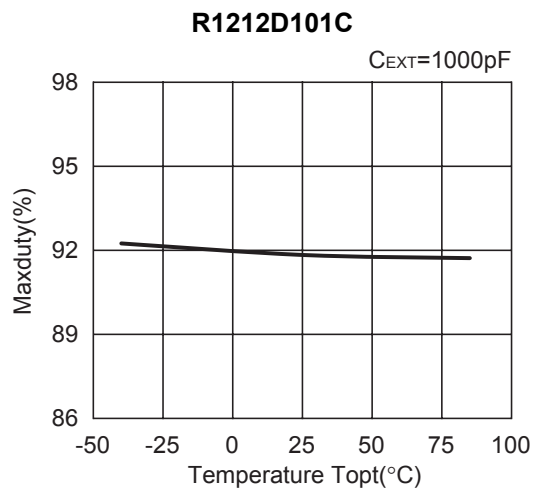
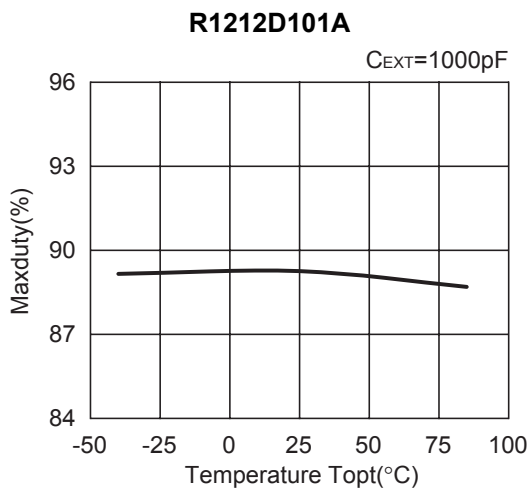

16) AMP "L" Output Current vs. Temperature

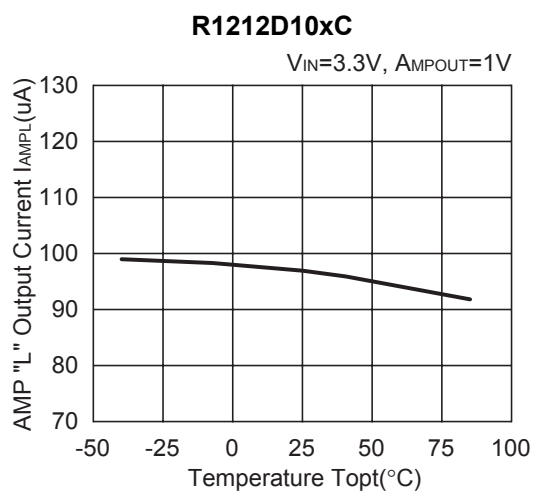
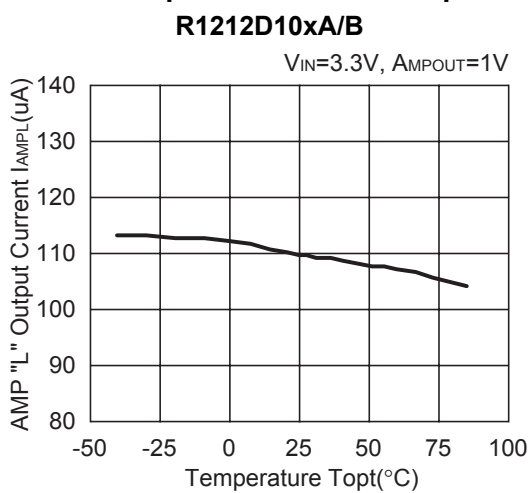

17) AMP "H" Output Current vs. Temperature

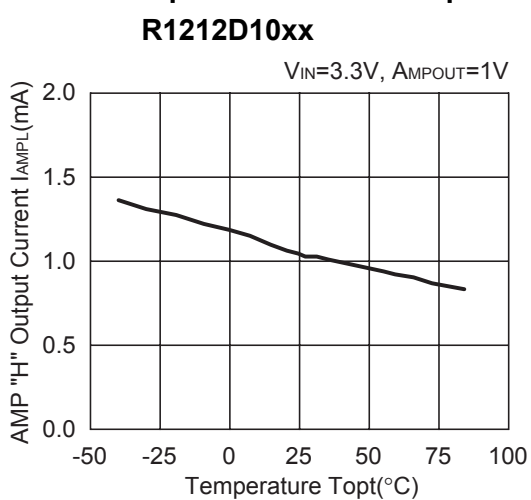

18) UVLO Detector Threshold UVLO Released Voltage vs. Temperature

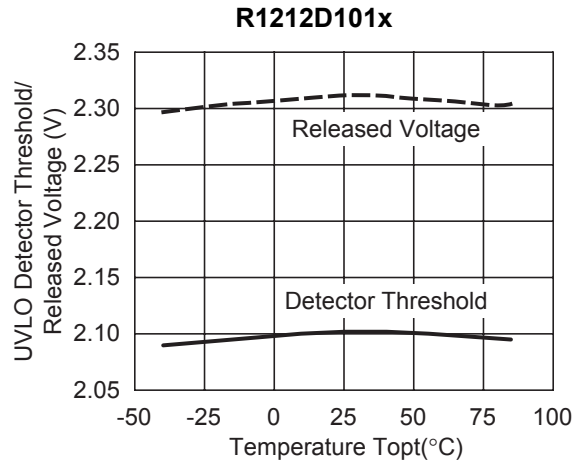
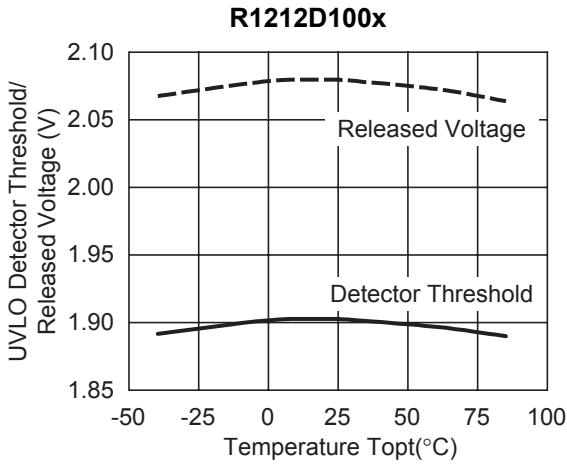

19) DELAY Pin Detector Threshold vs. Temperature

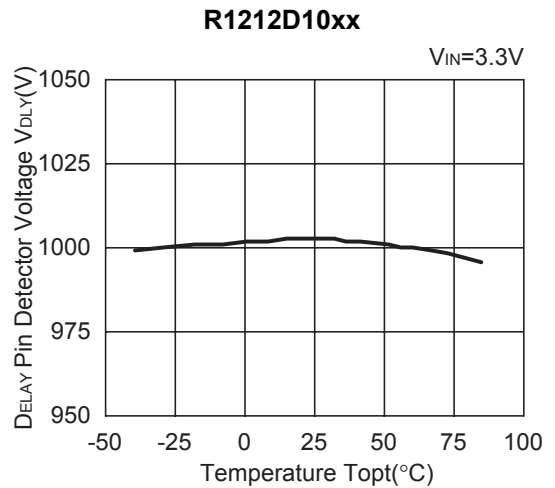
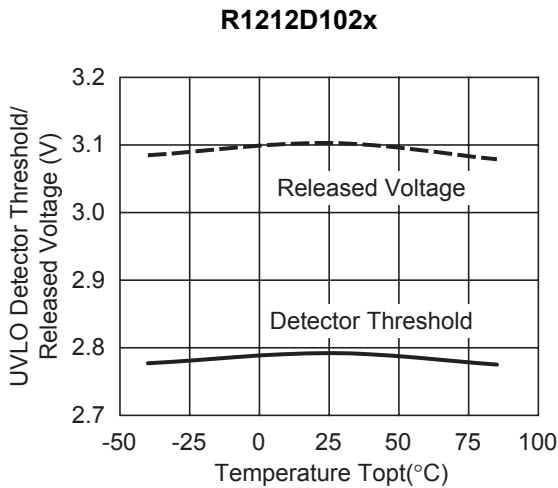

20) DELAY Pin Charge Current vs. Temperature

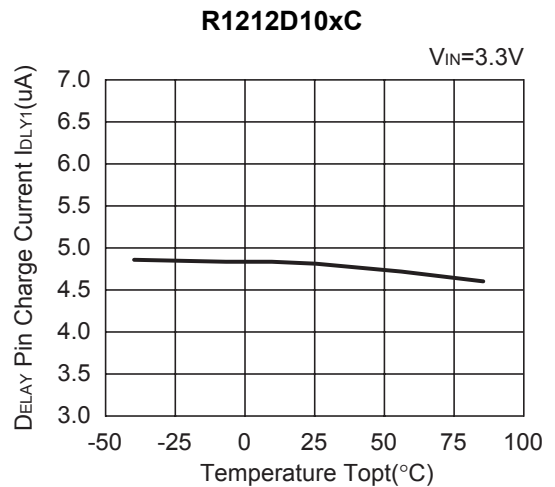
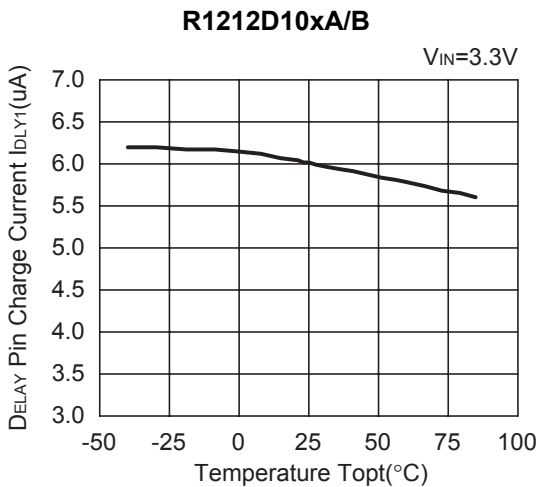

21) I_{DELAY} Pin Discharge Current vs. Temperature
R1212D10xx

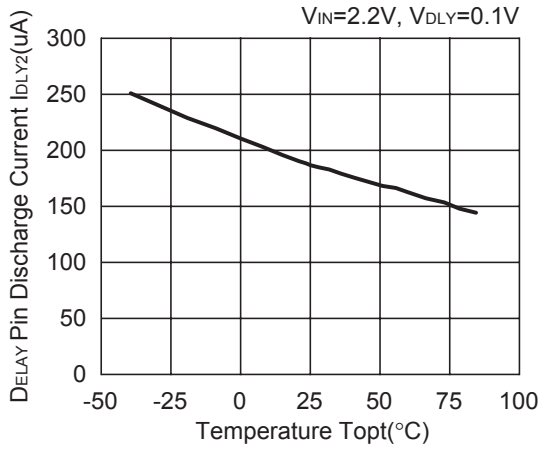

22) V_{REFOUT} Voltage vs. Temperature
R1212D10xx

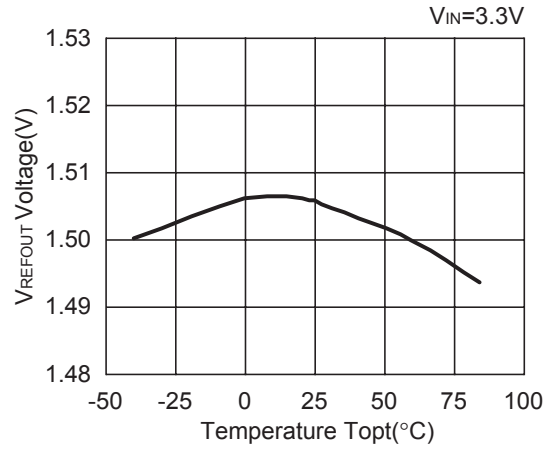

23) V_{REFOUT} Voltage vs. Input Voltage ($T_{\text{opt}}=25^{\circ}\text{C}$) 24) V_{REFOUT} Voltage vs. Output Current (1) ($T_{\text{opt}}=25^{\circ}\text{C}$)
R1212D10xx

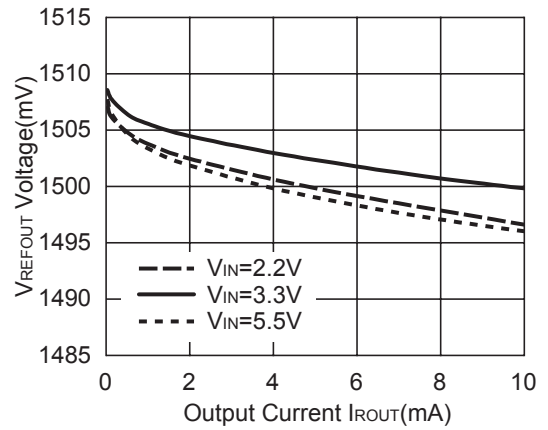
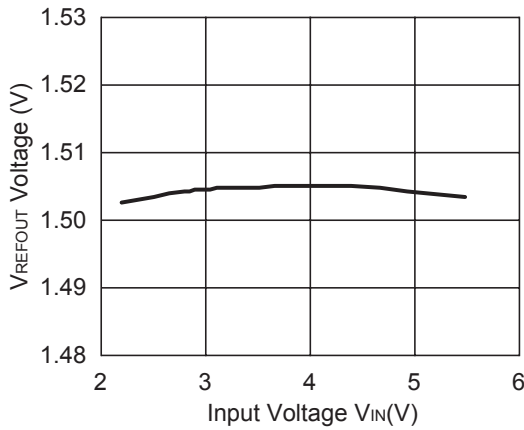

25) V_{REFOUT} Voltage vs. Output Current (2) ($T_{\text{opt}}=25^{\circ}\text{C}$) 26) Error Amplifier Gain/Phase vs. Frequency ($T_{\text{opt}}=25^{\circ}\text{C}$)
R1212D10xx

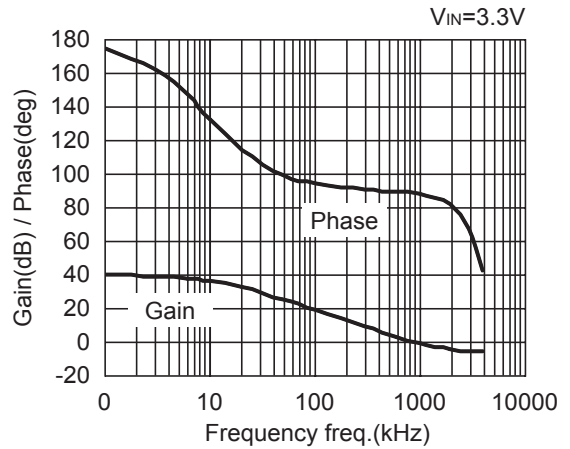
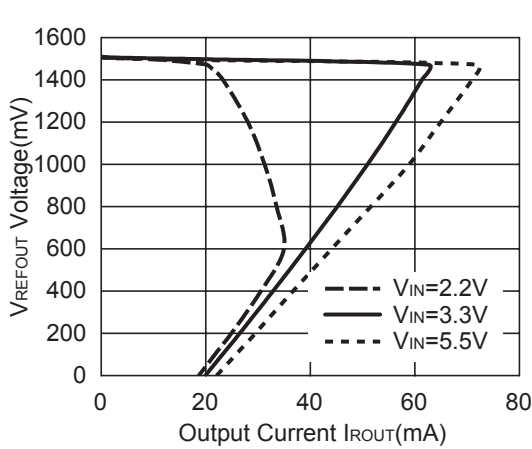

27) Power-on Response ($V_{IN}=3.3V$, $T_{opt}=25^{\circ}C$)

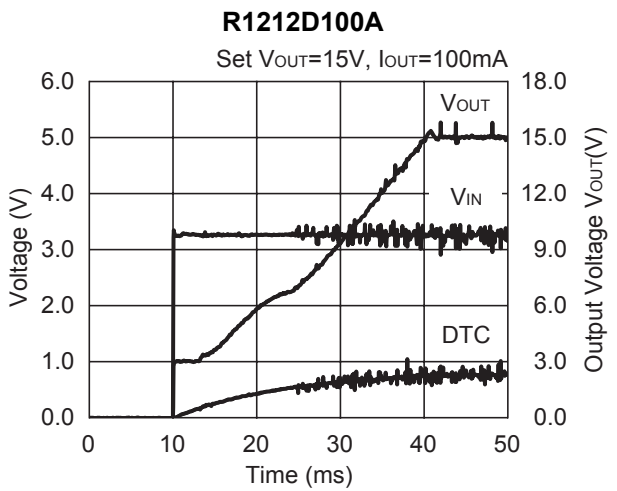
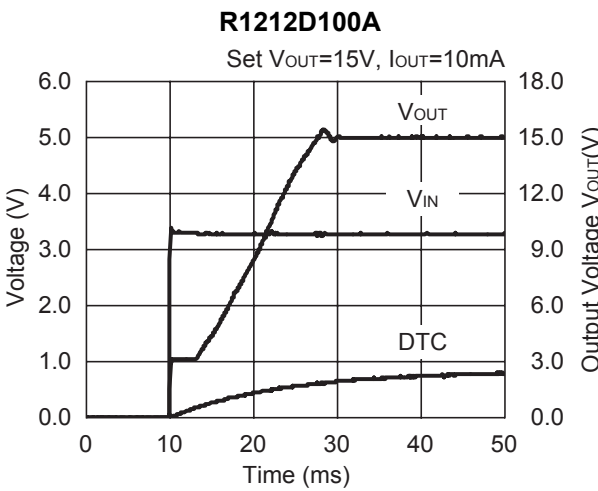
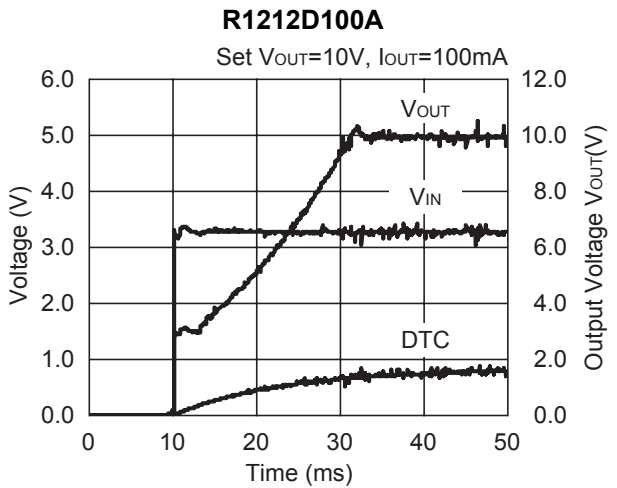
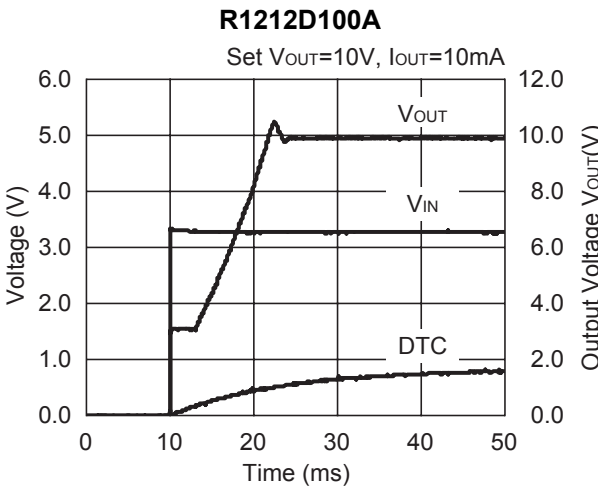
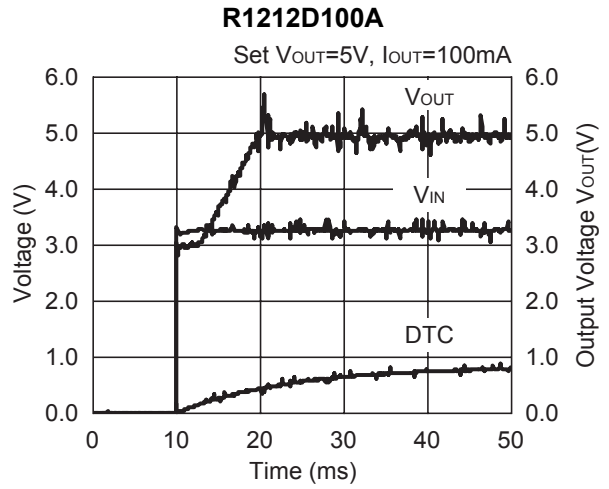
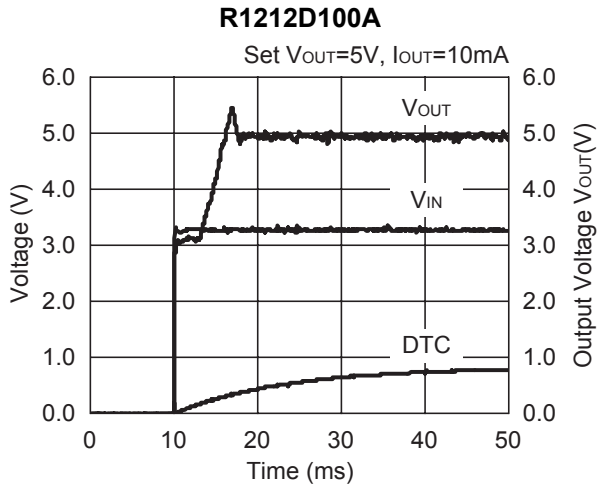

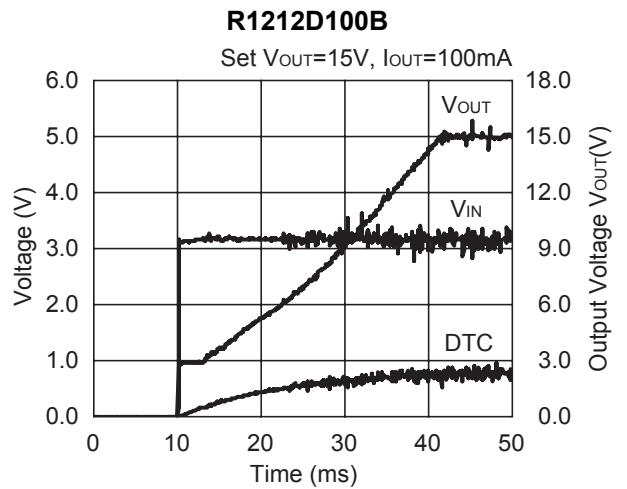
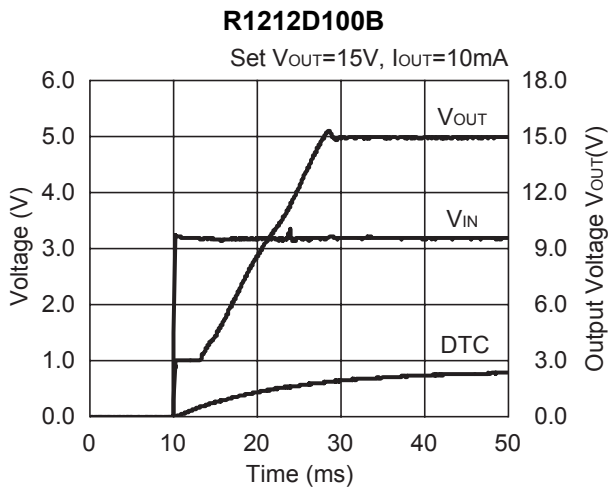
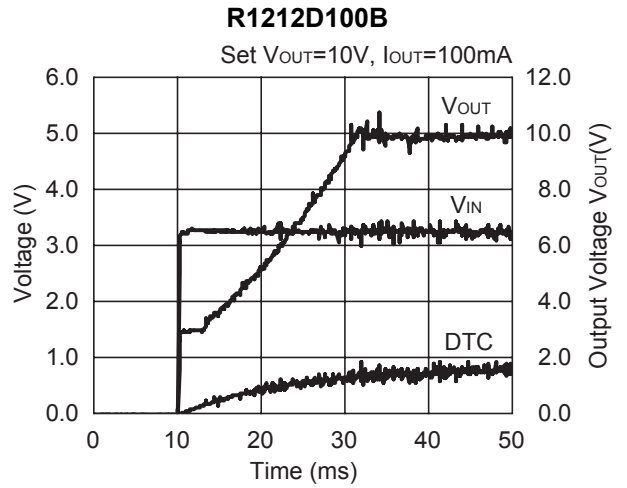
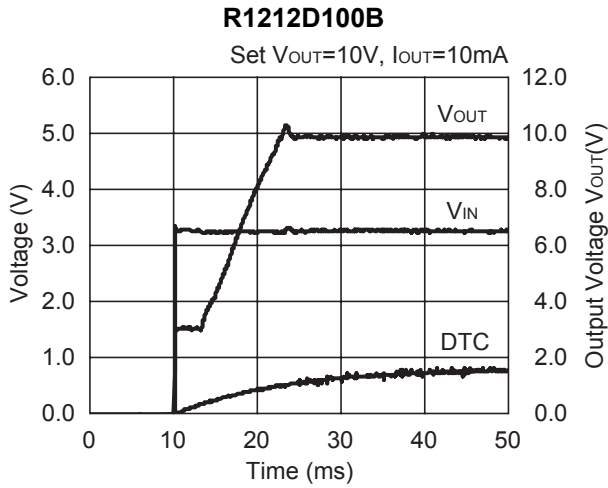
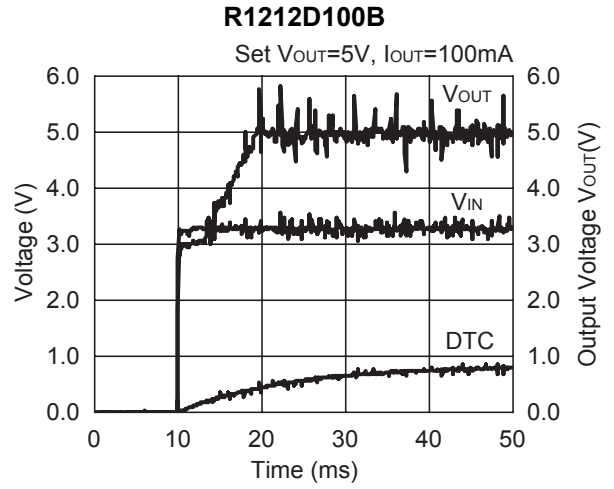
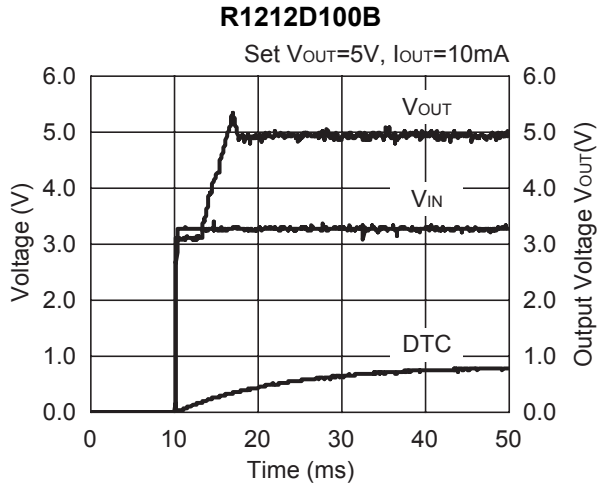

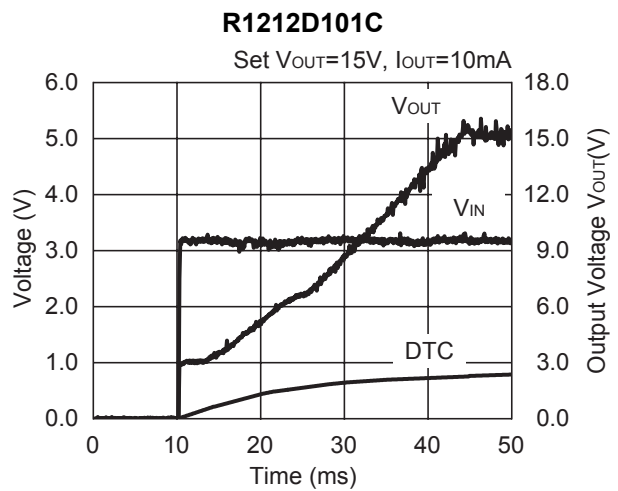
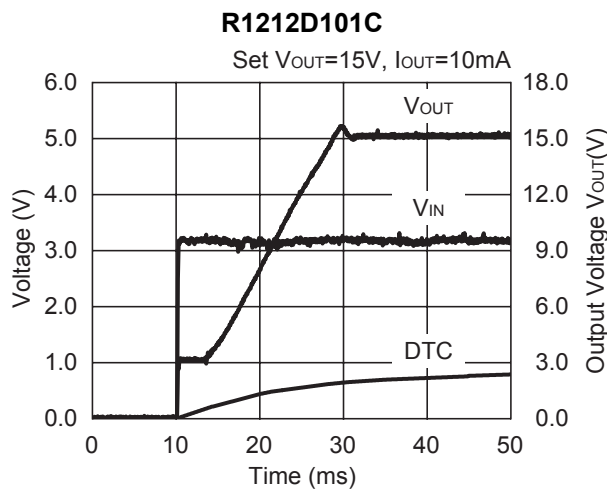
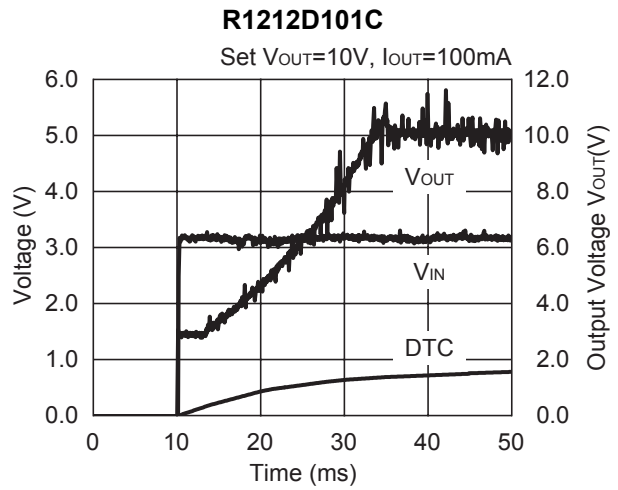
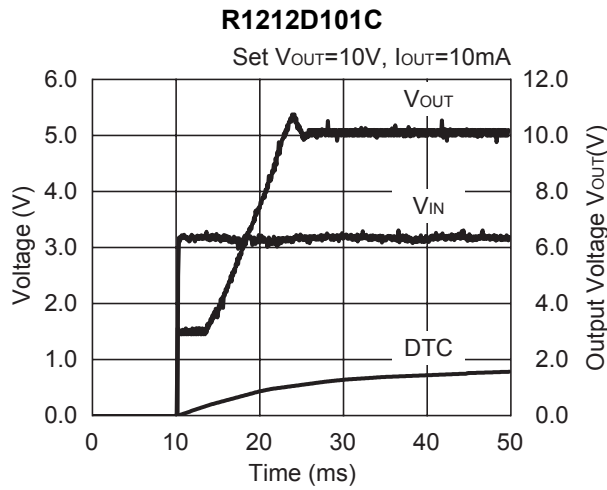
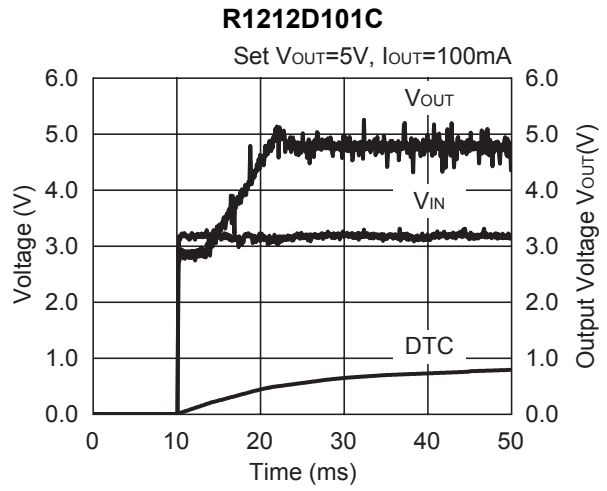
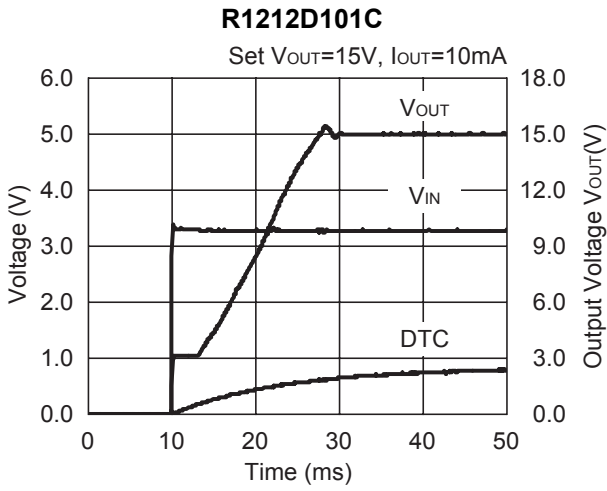

28) Load Transient Response ($V_{IN}=3.3V$, $T_{opt}=25^{\circ}C$)

R1212D100A

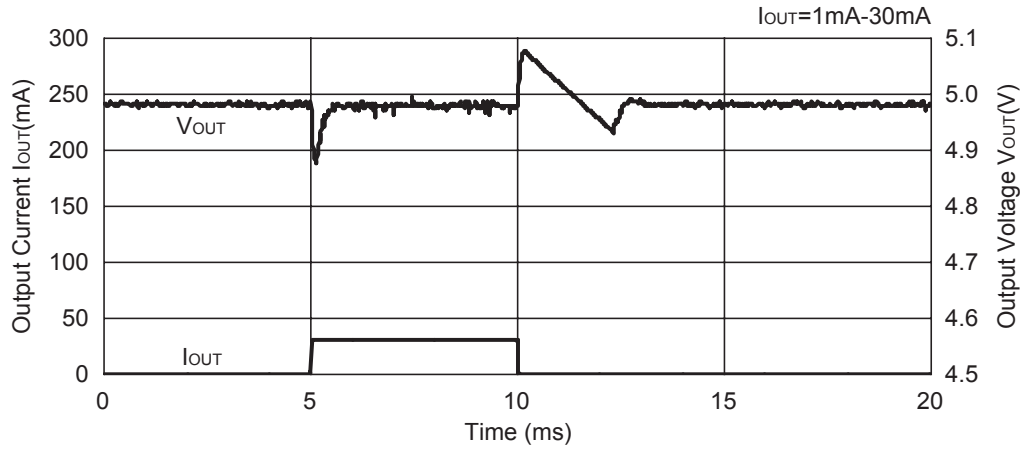

R1212D100A

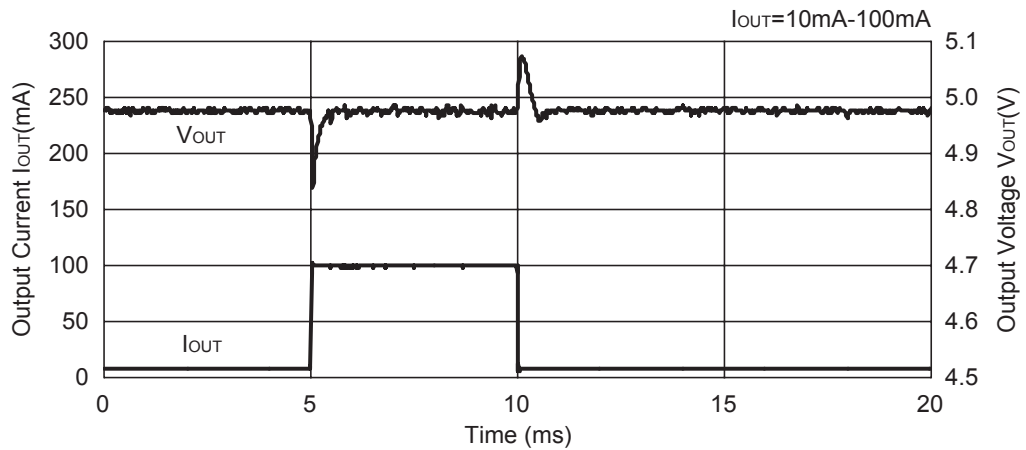

R1212D100A

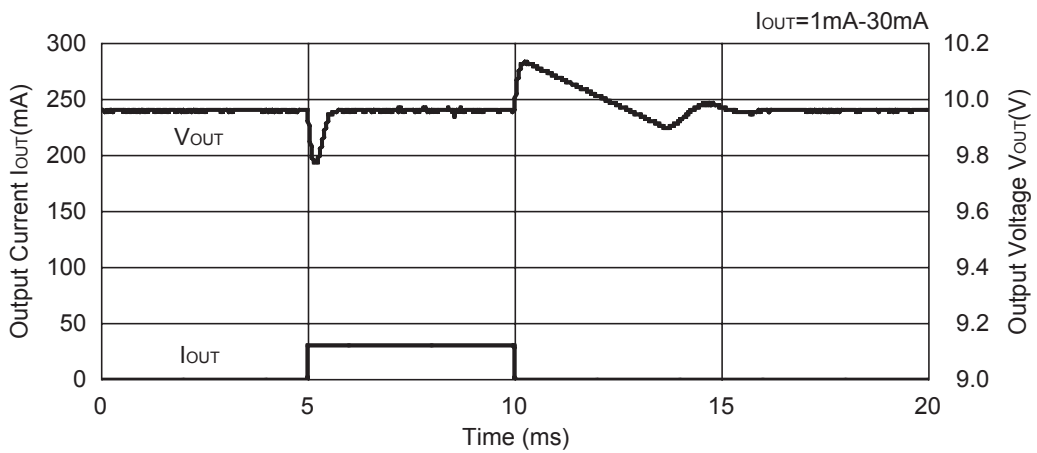

R1212D100A

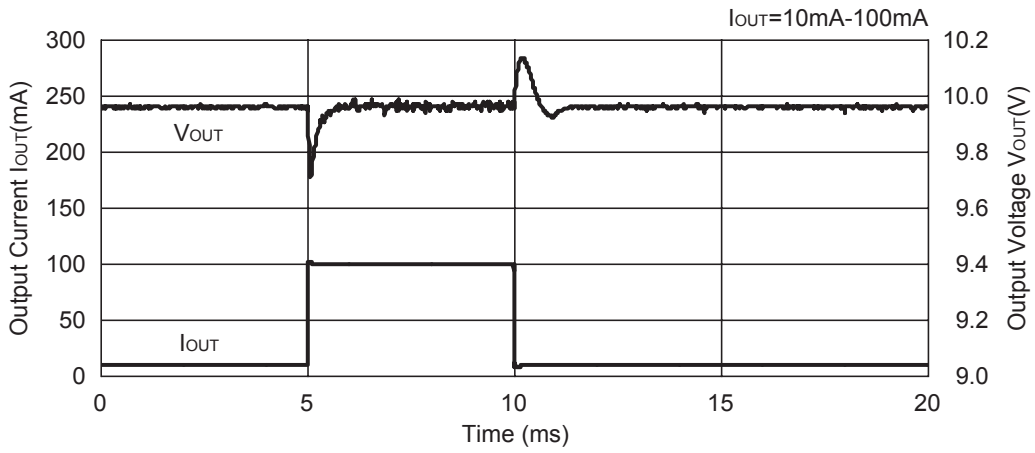

R1212D100A

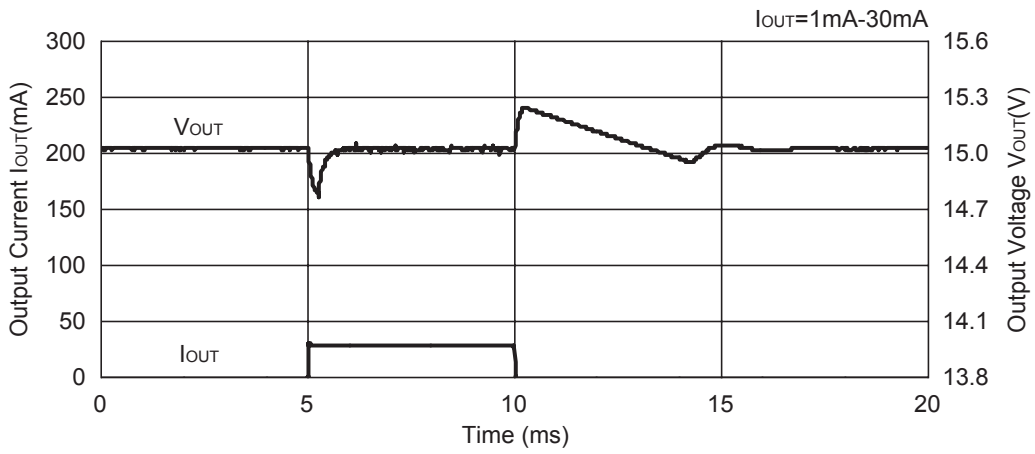

R1212D100A

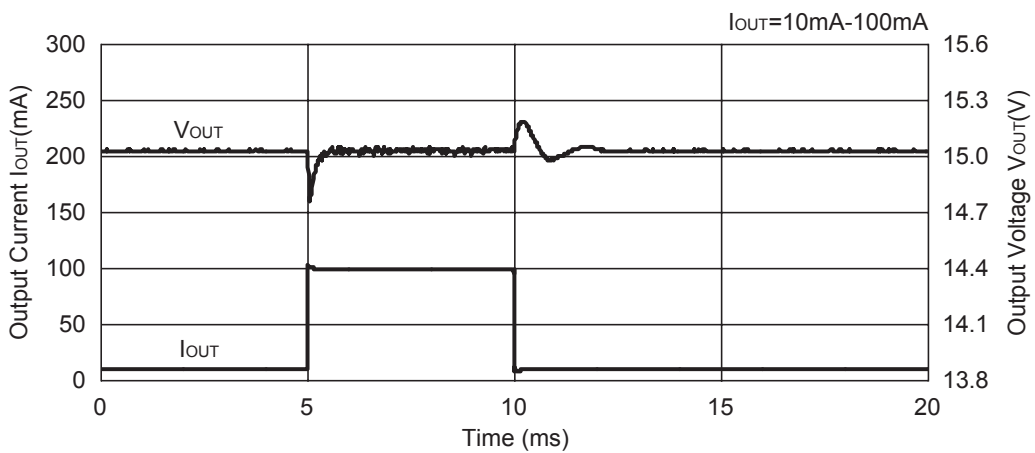

R1212D100B

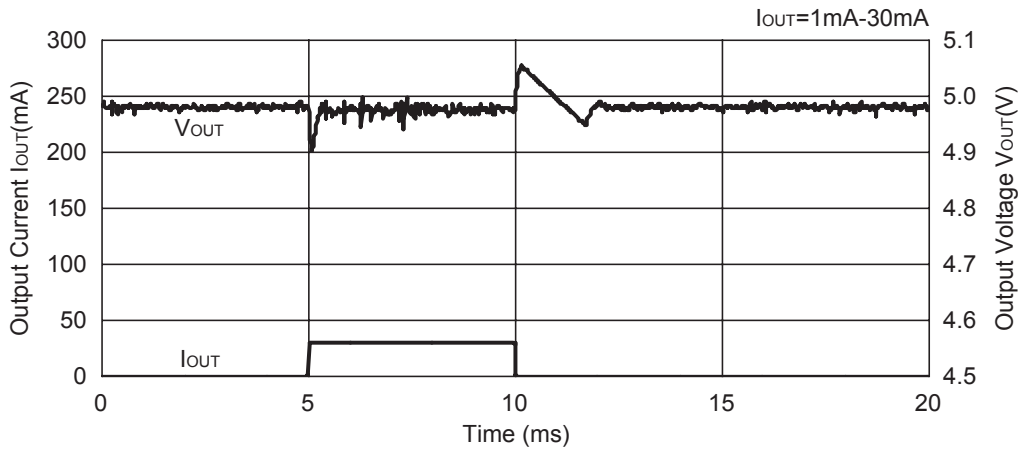

R1212D100B

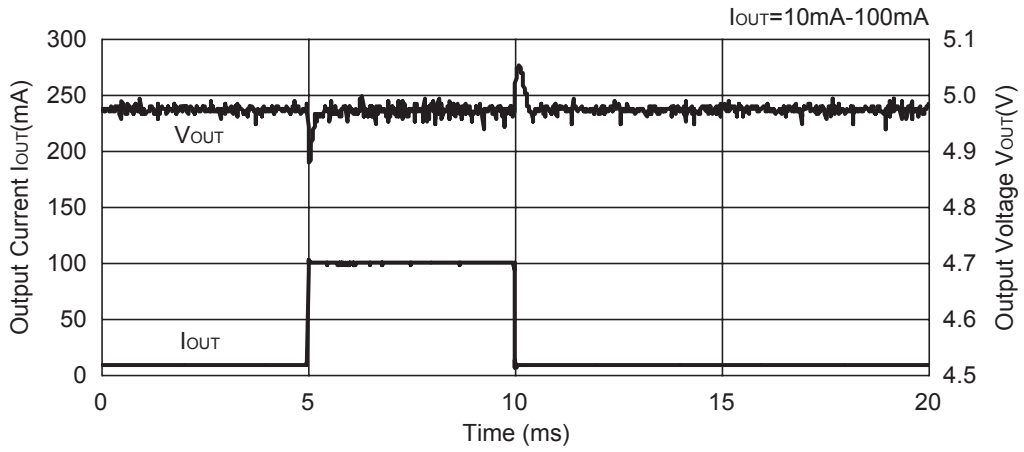

R1212D100B

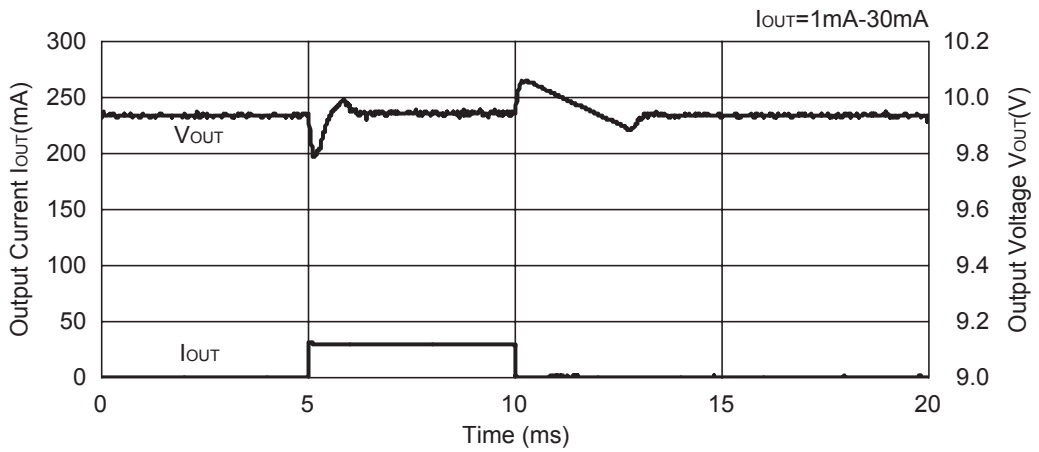

R1212D100B

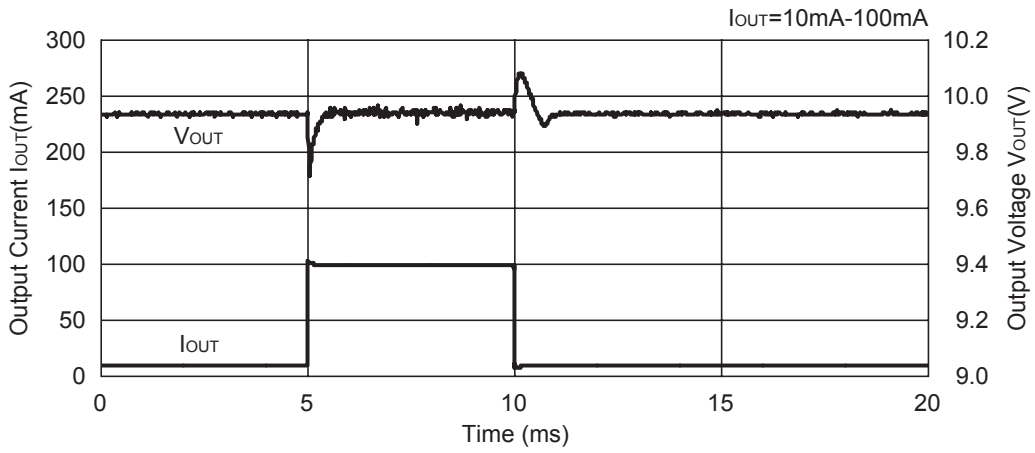

R1212D100B

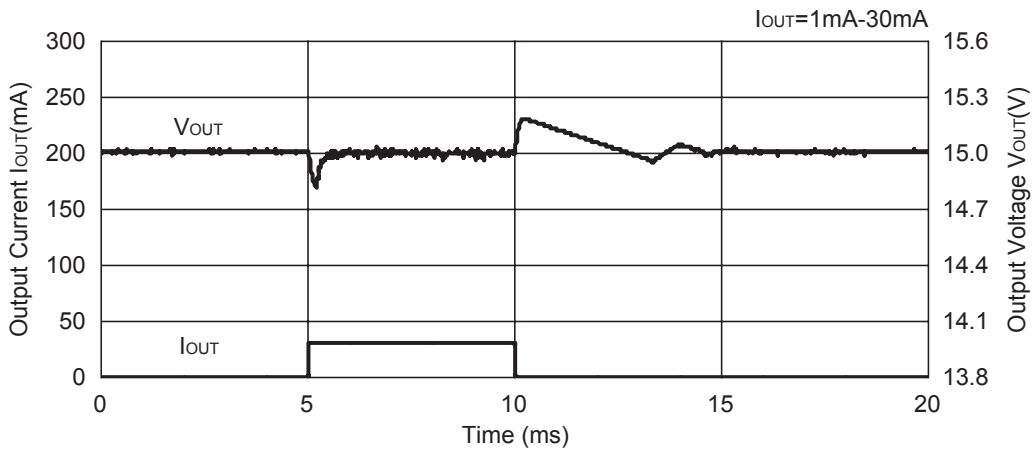

R1212D100B

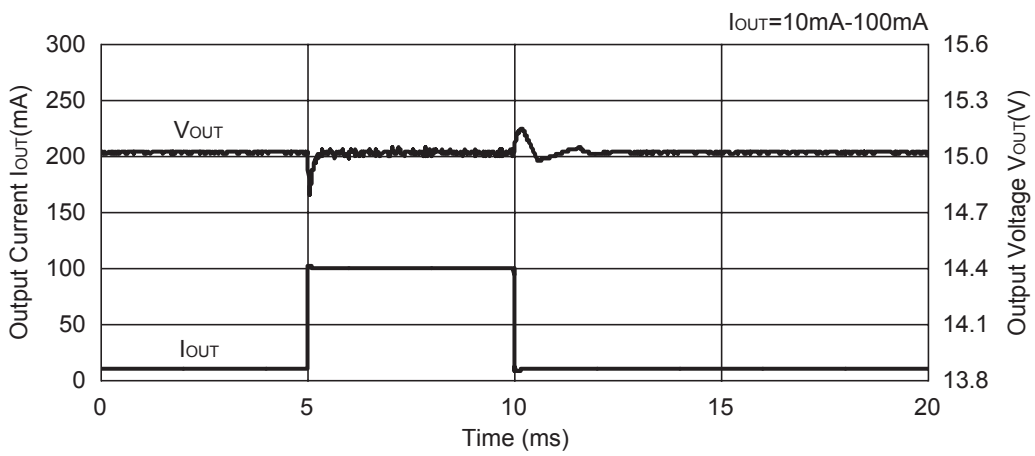

R1212D101C

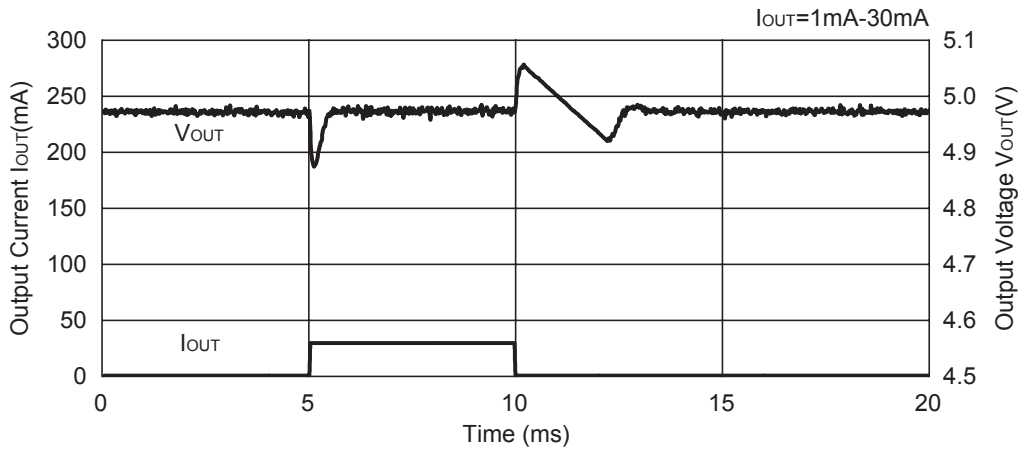

R1212D101C

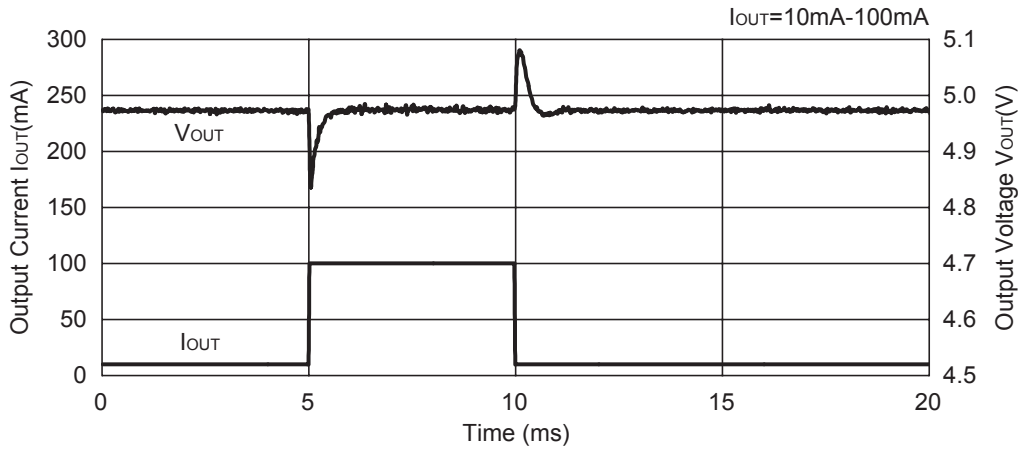

R1212D101C

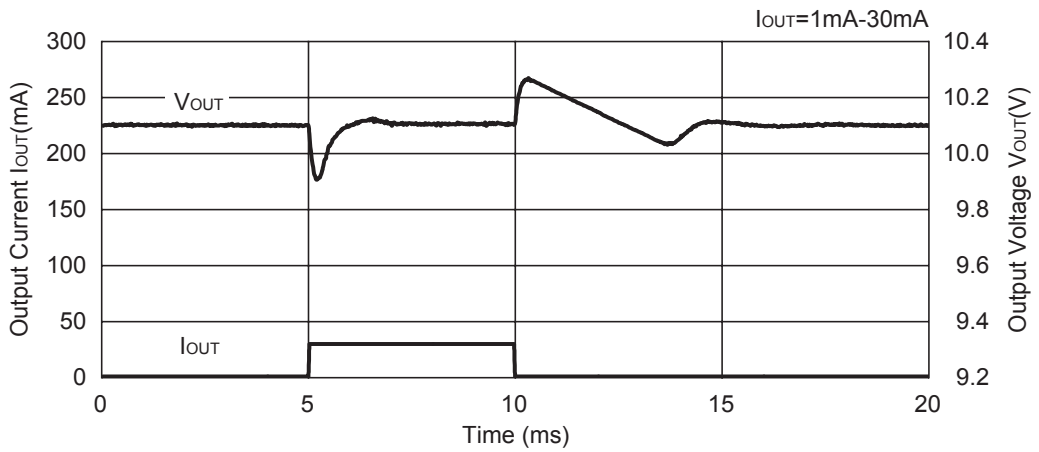

R1212D101C

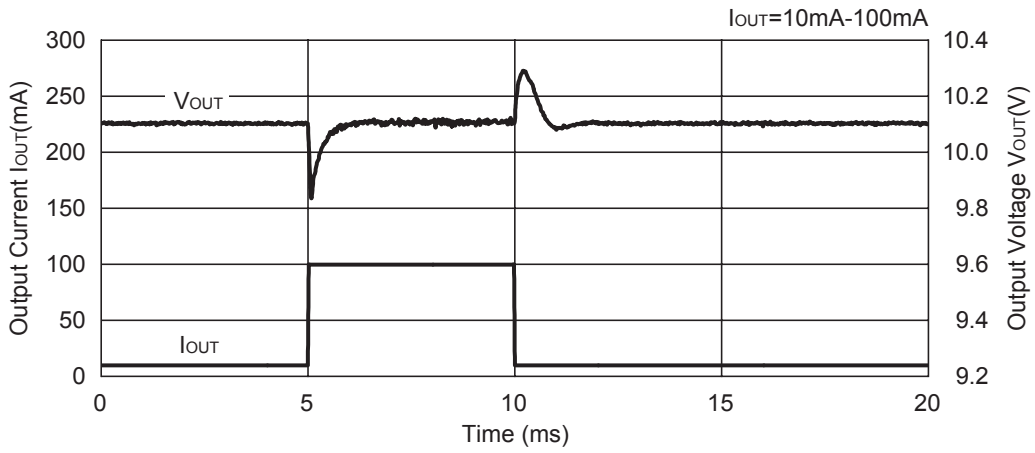

R1212D101C

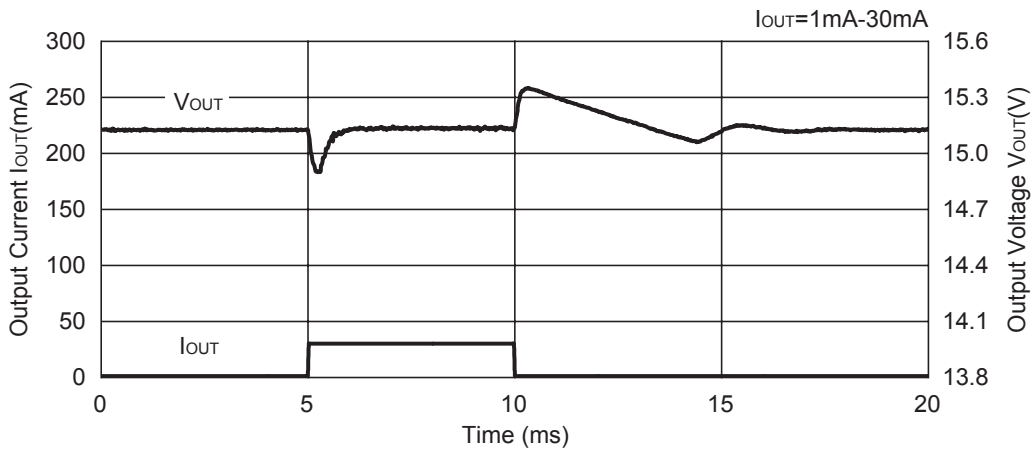

R1212D101C

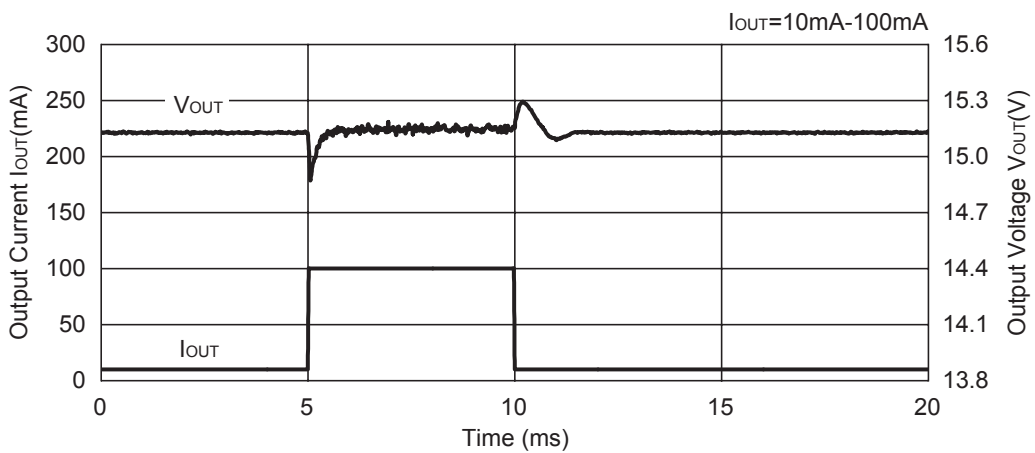

• SON-8

Unit: mm

PACKAGE DIMENSIONS

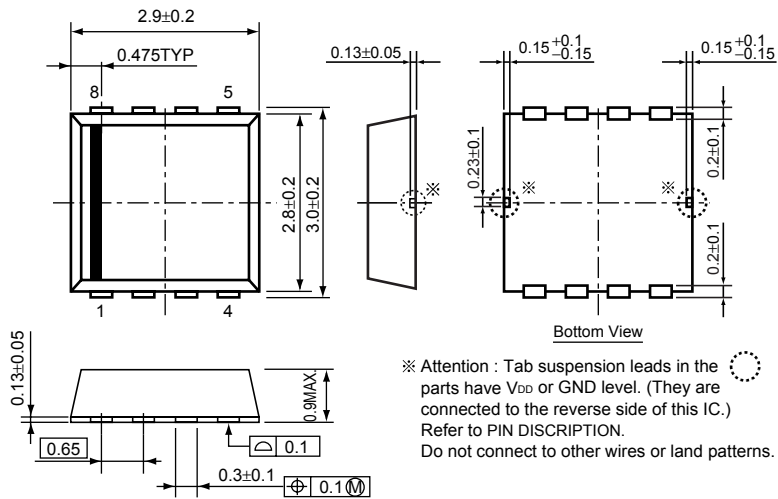

TAPING SPECIFICATION

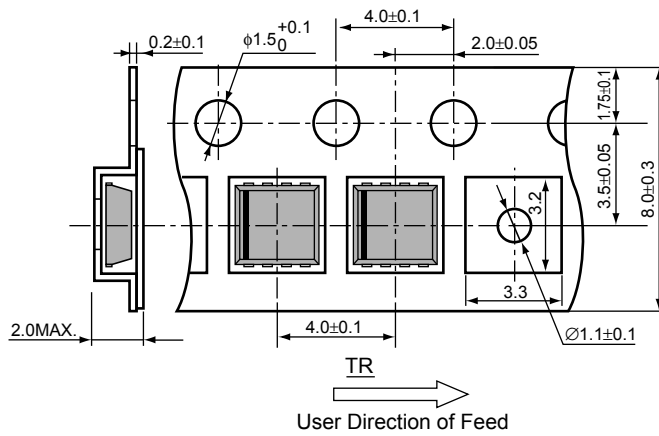

TAPING REEL DIMENSIONS

(1 reel=3000 pcs)

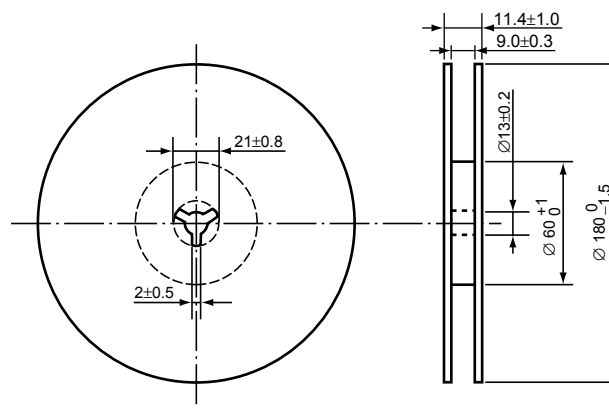

POWER DISSIPATION (SON-8)

This specification is at mounted on board. Power Dissipation (P_D) depends on conditions of mounting on board. This specification is based on the measurement at the condition below:

Measurement Conditions

	Standard Land Pattern
Environment	Mounting on Board (Wind velocity=0m/s)
Board Material	Glass cloth epoxy plactic (Double sided)
Board Dimensions	40mm × 40mm × 1.6mm
Copper Ratio	Top side : Approx. 50% , Back side : Approx. 50%
Through-hole	φ0.5mm × 44pcs

Measurement Result

($T_{opt}=25^{\circ}C, T_{jmax}=125^{\circ}C$)

	Standard Land Pattern	Free Air
Power Dissipation	480mW	300mW
Thermal Resistance	$\theta_{ja}=(125-25^{\circ}C)/0.48W=208^{\circ}C/W$	333 $^{\circ}C/W$

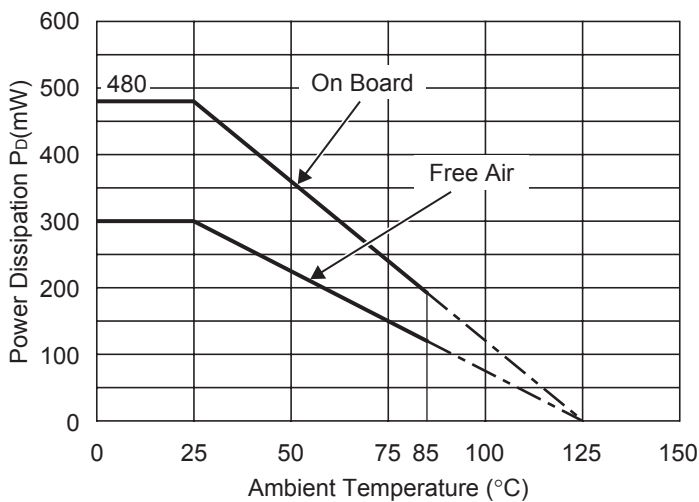

Power Dissipation

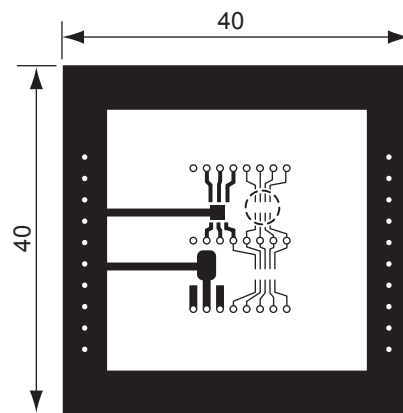

Measurement Board Pattern

○ IC Mount Area (Unit : mm)

RECOMMENDED LAND PATTERN

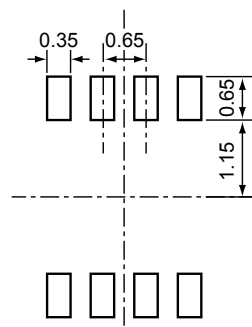

(Unit: mm)

R1212D SERIES MARK SPECIFICATION

• SON-8

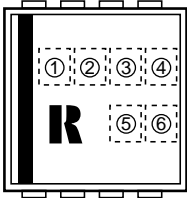

① to ④ : Product Code (refer to Part Number vs. Product Code)
 ⑤, ⑥ : Lot Number

• Part Number vs. Product Code

Part Number	Product Code			
	①	②	③	④
R1212D002A	F	0	2	A
R1212D100A	F	1	0	A
R1212D100B	F	1	0	B
R1212D101A	F	1	1	A
R1212D102A	F	1	2	A
R1212D101C	F	1	1	C
R1212D102C	F	1	2	C

Компания «Океан Электроники» предлагает заключение долгосрочных отношений при поставках импортных электронных компонентов на взаимовыгодных условиях!

Наши преимущества:

- Поставка оригинальных импортных электронных компонентов напрямую с производств Америки, Европы и Азии, а так же с крупнейших складов мира;
- Широкая линейка поставок активных и пассивных импортных электронных компонентов (более 30 млн. наименований);
- Поставка сложных, дефицитных, либо снятых с производства позиций;
- Оперативные сроки поставки под заказ (от 5 рабочих дней);
- Экспресс доставка в любую точку России;
- Помощь Конструкторского Отдела и консультации квалифицированных инженеров;
- Техническая поддержка проекта, помощь в подборе аналогов, поставка прототипов;
- Поставка электронных компонентов под контролем ВП;
- Система менеджмента качества сертифицирована по Международному стандарту ISO 9001;
- При необходимости вся продукция военного и аэрокосмического назначения проходит испытания и сертификацию в лаборатории (по согласованию с заказчиком);
- Поставка специализированных компонентов военного и аэрокосмического уровня качества (Xilinx, Altera, Analog Devices, Intersil, Interpoint, Microsemi, Actel, Aeroflex, Peregrine, VPT, Syfer, Eurofarad, Texas Instruments, MS Kennedy, Miteq, Cobham, E2V, MA-COM, Hittite, Mini-Circuits, General Dynamics и др.);

Компания «Океан Электроники» является официальным дистрибьютором и эксклюзивным представителем в России одного из крупнейших производителей разъемов военного и аэрокосмического назначения «JONHON», а так же официальным дистрибьютором и эксклюзивным представителем в России производителя высокотехнологичных и надежных решений для передачи СВЧ сигналов «FORSTAR».



JONHON

«JONHON» (основан в 1970 г.)

Разъемы специального, военного и аэрокосмического назначения:

(Применяются в военной, авиационной, аэрокосмической, морской, железнодорожной, горно- и нефтедобывающей отраслях промышленности)

«FORSTAR» (основан в 1998 г.)

ВЧ соединители, коаксиальные кабели,
кабельные сборки и микроволновые компоненты:

(Применяются в телекоммуникациях гражданского и специального назначения, в средствах связи, РЛС, а так же военной, авиационной и аэрокосмической отраслях промышленности).



Телефон: 8 (812) 309-75-97 (многоканальный)

Факс: 8 (812) 320-03-32

Электронная почта: ocean@oceanchips.ru

Web: <http://oceanchips.ru/>

Адрес: 198099, г. Санкт-Петербург, ул. Калинина, д. 2, корп. 4, лит. А