

**DUAL COMPLEMENTARY PRE-BIASED TRANSISTOR**
**Features**

- Epitaxial Planar Die Construction
- Built-In Biasing Resistors
- **Available in Lead Free/RoHS Compliant Version (Note 1)**
- **“Green” Device (Note 2)**

Part Number	R1	R2	Marking
DCX124EK	22K $\Omega$	22K $\Omega$	C17
DCX144EK	47K $\Omega$	47K $\Omega$	C20
DCX114YK	10K $\Omega$	47K $\Omega$	C14
DCX123JK	2.2K $\Omega$	47K $\Omega$	C06
DCX114EK	10K $\Omega$	10K $\Omega$	C13
DCX115EK	100K $\Omega$	100K $\Omega$	C15
DCX143TK	4.7K $\Omega$	-	C07
DCX114TK	10K $\Omega$	-	C12

**Mechanical Data**

- Case: SC-74R (Note 3)
- Case Material: Molded Plastic, “Green” Molding Compound. UL Flammability Classification Rating 94V-0
- Moisture Sensitivity: Level 1 per J-STD-020D
- Terminals: Matte Tin Finish annealed over Copper leadframe (Lead Free Plating) Solderable per MIL-STD-202, Method 208
- Terminal Connections: See Diagram
- Marking Information: See Table and Page 11
- Ordering Information: See Page 11
- Weight: 0.015 grams (approximate)

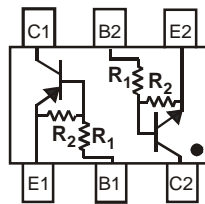

R1, R2 Device Schematic

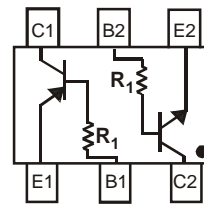

R1 only Device Schematic

**Maximum Ratings NPN Section** @ $T_A = 25^\circ\text{C}$  unless otherwise specified

Characteristic	Symbol	Value	Unit	
Supply Voltage	$V_{CC}$	50	V	
Input Voltage	$V_{IN}$	DCX124EK	-10 to +40	
		DCX144EK	-10 to +40	
		DCX114YK	-6 to +40	
		DCX123JK	-5 to +12	
		DCX114EK	-10 to +40	
		DCX115EK	-10 to +40	
		DCX143TK	-5V max	
		DCX114TK	-5V max	
Output Current	$I_O$	DCX124EK	30	
		DCX144EK	30	
		DCX114YK	70	
		DCX123JK	100	
		DCX114EK	50	
		DCX115EK	20	
		DCX143TK	100	
		DCX114TK	100	
Output Current	All	$I_{C(MAX)}$	100	mA

**Thermal Characteristics NPN Section**

Characteristic	Symbol	Value	Unit
Power Dissipation (Total) (Note 4)	$P_D$	300	mW
Thermal Resistance, Junction to Ambient Air (Note 4)	$R_{\theta JA}$	417	$^\circ\text{C/W}$
Operating and Storage Temperature Range	$T_J, T_{STG}$	-55 to +150	$^\circ\text{C}$

- Notes:
1. No purposefully added lead.
  2. Diodes Inc.'s "Green" policy can be found on our website at [http://www.diodes.com/products/lead\\_free/index.php](http://www.diodes.com/products/lead_free/index.php).
  3. SC-74R and SOT-26 have identical dimensions and the only difference is the location of the pin one indicator. Please see the individual device datasheets for exact details regarding the location of the pin one indicator.
  4. Mounted on FR4 PC Board with recommended pad layout at <http://www.diodes.com/datasheets/ap02001.pdf>. 200mW per element must not be exceeded.

**Maximum Ratings PNP Section** @T<sub>A</sub> = 25°C unless otherwise specified

Characteristic	Symbol	Value	Unit	
Supply Voltage	V <sub>CC</sub>	50	V	
Input Voltage	V <sub>IN</sub>	DCX124EK	+10 to -40	
		DCX144EK	+10 to -40	
		DCX114YK	+6 to -40	
		DCX123JK	+5 to -12	
		DCX114EK	+10 to -40	
		DCX115EK	+10 to -40	
		DCX143TK DCX114TK	+5V max +5V max	
Output Current	I <sub>O</sub>	DCX124EK	-30	
		DCX144EK	-30	
		DCX114YK	-70	
		DCX123JK	-100	
		DCX114EK	-50	
		DCX115EK	-20	
		DCX143TK DCX114TK	-100 -100	
Output Current	All	I <sub>C(MAX)</sub>	-100	mA

**Thermal Characteristics PNP Section**

Characteristic	Symbol	Value	Unit
Power Dissipation (Total) (Note 4)	P <sub>D</sub>	300	mW
Thermal Resistance, Junction to Ambient Air (Note 4)	R <sub>θJA</sub>	833	°C/W
Operating and Storage Temperature Range	T <sub>J</sub> , T <sub>STG</sub>	-55 to +150	°C

**Electrical Characteristics NPN Section** @T<sub>A</sub> = 25°C unless otherwise specified

Characteristic (DDC143TK & DDC114TK only)	Symbol	Min	Typ	Max	Unit	Test Condition
Collector-Base Breakdown Voltage	BV <sub>CBO</sub>	50	—	—	V	I <sub>C</sub> = 50μA
Collector-Emitter Breakdown Voltage	BV <sub>CEO</sub>	50	—	—	V	I <sub>C</sub> = 1mA
Emitter-Base Breakdown Voltage	BV <sub>EBO</sub>	5	—	—	V	I <sub>E</sub> = 50μA
Collector Cutoff Current	I <sub>CBO</sub>	—	—	0.5	μA	V <sub>CB</sub> = 50V
Emitter Cutoff Current	I <sub>EBO</sub>	—	—	0.5	μA	V <sub>EB</sub> = 4V
Collector-Emitter Saturation Voltage	V <sub>CE(SAT)</sub>	—	—	0.3	V	I <sub>C</sub> /I <sub>B</sub> = 2.5mA / 0.25mA – DCX143TK I <sub>C</sub> /I <sub>B</sub> = 1mA / 0.1mA – DCX114TK
DC Current Transfer Ratio	h <sub>FE</sub>	100	250	600	—	I <sub>C</sub> = 1mA, V <sub>CE</sub> = 5V
Input Resistor (R <sub>1</sub> ) Tolerance	ΔR <sub>1</sub>	-30	—	+30	%	—
Gain-Bandwidth Product*	f <sub>T</sub>	—	250	—	MHz	V <sub>CE</sub> = 10V, I <sub>E</sub> = -5mA, f = 100MHz

\* Transistor - For Reference Only

**Electrical Characteristics NPN Section (continued)** @T<sub>A</sub> = 25°C unless otherwise specified

Characteristic		Symbol	Min	Typ	Max	Unit	Test Condition
Input Voltage	DCX124EK DCX144EK DCX114YK DCX123JK DCX114EK DCX115EK	V <sub>I(OFF)</sub>	0.5 0.5 0.3 0.5 0.5 0.5	1.1 1.1 — — 1.1 1.1	—	V	V <sub>CC</sub> = 5V, I <sub>O</sub> = 100μA
	DCX124EK DCX144EK DCX114YK DCX123JK DCX114EK DCX115EK		V <sub>I(ON)</sub>	—	1.65 1.9 — — 1.9 1.9	3.0 3.0 1.4 1.1 3.0 3.0	V
Output Voltage	DCX124EK DCX144EK DCX114YK DCX123JK DCX114EK DCX115EK	V <sub>O(ON)</sub>		—	0.1	0.3	V
Input Current	DCX124EK DCX144EK DCX114YK DCX123JK DCX114EK DCX115EK	I <sub>I</sub>	—	—	0.36 0.18 0.88 3.6 0.88 0.15	mA	V <sub>I</sub> = 5V
Output Current		I <sub>O(OFF)</sub>	—	—	0.5	μA	V <sub>CC</sub> = 50V, V <sub>I</sub> = 0V
DC Current Gain	DCX124EK DCX144EK DCX114YK DCX123JK DCX114EK DCX115EK	G <sub>I</sub>	80 68 68 80 30 82	—	—	—	V <sub>O</sub> = 5V, I <sub>O</sub> = 5mA V <sub>O</sub> = 5V, I <sub>O</sub> = 5mA V <sub>O</sub> = 5V, I <sub>O</sub> = 10mA V <sub>O</sub> = 5V, I <sub>O</sub> = 10mA V <sub>O</sub> = 5V, I <sub>O</sub> = 5mA V <sub>O</sub> = 5V, I <sub>O</sub> = 5mA
Input Resistor (R <sub>1</sub> ) Tolerance		ΔR <sub>1</sub>	-30	—	+30	%	—
Resistance Ratio Tolerance		R <sub>2</sub> /R <sub>1</sub>	-20	—	+20	%	—
Gain-Bandwidth Product*		f <sub>T</sub>	—	250	—	MHz	V <sub>CE</sub> = 10V, I <sub>E</sub> = -5mA, f = 100MHz

\* Transistor - For Reference Only

**Electrical Characteristics PNP Section** @T<sub>A</sub> = 25°C unless otherwise specified

Characteristic (DCX143TK & DCX114TK only)		Symbol	Min	Typ	Max	Unit	Test Condition
Collector-Base Breakdown Voltage		BV <sub>CB0</sub>	-50	—	—	V	I <sub>C</sub> = -50μA
Collector-Emitter Breakdown Voltage		BV <sub>CEO</sub>	-50	—	—	V	I <sub>C</sub> = -1mA
Emitter-Base Breakdown Voltage		BV <sub>EBO</sub>	-5	—	—	V	I <sub>E</sub> = -50μA
Collector Cutoff Current		I <sub>CB0</sub>	—	—	-0.5	μA	V <sub>CB</sub> = -50V
Emitter Cutoff Current		I <sub>EBO</sub>	—	—	-0.5	μA	V <sub>EB</sub> = -4V
Collector-Emitter Saturation Voltage		V <sub>CE(SAT)</sub>	—	—	-0.3	V	I <sub>C</sub> /I <sub>B</sub> = -2.5mA / -0.25mA - DCX143TK I <sub>C</sub> /I <sub>B</sub> = -1mA / -0.1mA - DCX114TK
DC Current Transfer Ratio		h <sub>FE</sub>	100	250	600	—	I <sub>C</sub> = -1mA, V <sub>CE</sub> = -5V
Input Resistor (R <sub>1</sub> ) Tolerance		ΔR <sub>1</sub>	-30	—	+30	%	—
Gain-Bandwidth Product*		f <sub>T</sub>	—	250	—	MHz	V <sub>CE</sub> = -10V, I <sub>E</sub> = 5mA, f = 100MHz

\* Transistor - For Reference Only

**Electrical Characteristics PNP Section (Continued)** @T<sub>A</sub> = 25°C unless otherwise specified

Characteristic		Symbol	Min	Typ	Max	Unit	Test Condition
Input Voltage	DCX124EK DCX144EK DCX114YK DCX123JK DCX114EK DCX115EK	V <sub>I(OFF)</sub>	-0.5 -0.5 -0.3 -0.5 -0.5 -0.5	-1.1 -1.1 — — -1.1 -1.1	— — — — — —	V	V <sub>CC</sub> = -5V, I <sub>O</sub> = -100μA
	DCX124EK DCX144EK DCX114YK DCX123JK DCX114EK DCX115EK	V <sub>I(ON)</sub>	— — — — -1.9 -1.9	-1.9 -1.9 — — -3.0 -3.0	-3.0 -3.0 -1.4 -1.1 -3.0 -3.0	V	V <sub>O</sub> = -0.3V, I <sub>O</sub> = -5mA V <sub>O</sub> = -0.3V, I <sub>O</sub> = -2mA V <sub>O</sub> = -0.3V, I <sub>O</sub> = -1mA V <sub>O</sub> = -0.3V, I <sub>O</sub> = -5mA V <sub>O</sub> = -0.3V, I <sub>O</sub> = -10mA V <sub>O</sub> = -0.3V, I <sub>O</sub> = -1mA
Output Voltage	DCX124EK DCX144EK DCX114YK DCX123JK DCX114EK DCX115EK	V <sub>O(ON)</sub>	—	-0.1	-0.3	V	I <sub>O</sub> /I <sub>I</sub> = -10mA / -0.5mA I <sub>O</sub> /I <sub>I</sub> = -10mA / -0.5mA I <sub>O</sub> /I <sub>I</sub> = -5mA / -0.25mA I <sub>O</sub> /I <sub>I</sub> = -5mA / -0.25mA I <sub>O</sub> /I <sub>I</sub> = -10mA / -0.5mA I <sub>O</sub> /I <sub>I</sub> = -5mA / -0.25mA
Input Current	DCX124EK DCX144EK DCX114YK DCX123JK DCX114EK DCX115EK	I <sub>I</sub>	—	—	-0.36 -0.18 -0.88 -3.6 -0.88 -0.15	mA	V <sub>I</sub> = -5V
Output Current		I <sub>O(OFF)</sub>	—	—	-0.5	μA	V <sub>CC</sub> = 50V, V <sub>I</sub> = 0V
DC Current Gain	DCX124EK DCX144EK DCX114YK DCX123JK DCX114EK DCX115EK	G <sub>I</sub>	80 68 68 80 30 82	—	—	—	V <sub>O</sub> = -5V, I <sub>O</sub> = -5mA V <sub>O</sub> = -5V, I <sub>O</sub> = -5mA V <sub>O</sub> = -5V, I <sub>O</sub> = -10mA V <sub>O</sub> = -5V, I <sub>O</sub> = -10mA V <sub>O</sub> = -5V, I <sub>O</sub> = -5mA V <sub>O</sub> = -5V, I <sub>O</sub> = -5mA
Input Resistor (R <sub>1</sub> ) Tolerance		ΔR <sub>1</sub>	-30	—	+30	%	—
Resistance Ratio Tolerance		R <sub>2</sub> /R <sub>1</sub>	-20	—	+20	%	—
Gain-Bandwidth Product*		f <sub>T</sub>	—	250	—	MHZ	V <sub>CE</sub> = -10V, I <sub>E</sub> = -5mA, f = 100MHZ

\*Transistor - For Reference Only

**Typical Curves – Total Device**

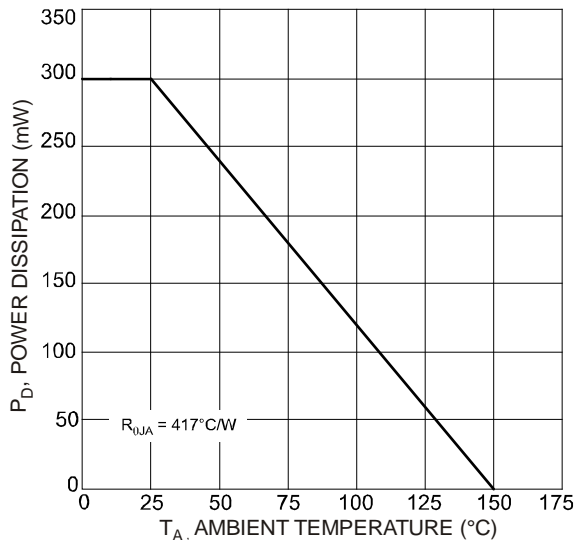

Fig. 1 Power Dissipation vs. Ambient Temperature

**Typical Curves – DCX124EK PNP Section**

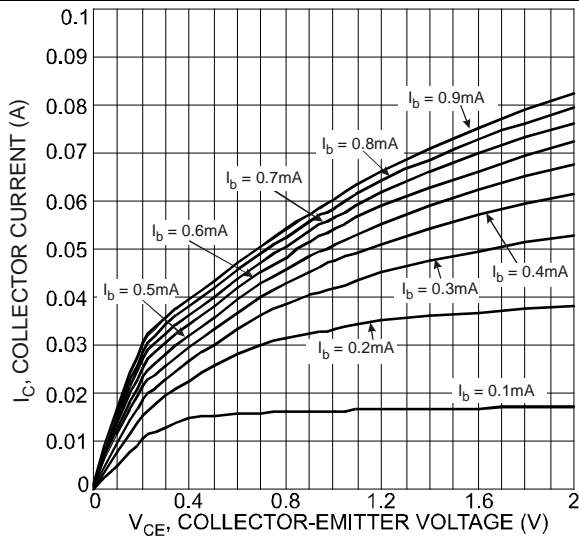

Fig. 2 Typical Collector Current vs. Collector-Emitter Voltage

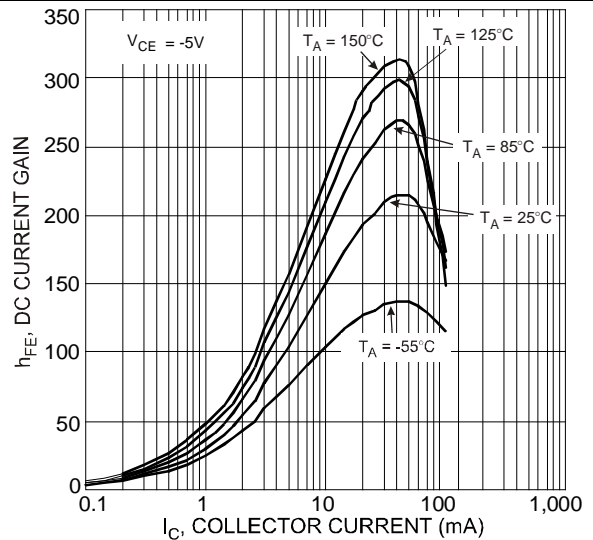

Fig. 3 Typical DC Current Gain vs. Collector Current

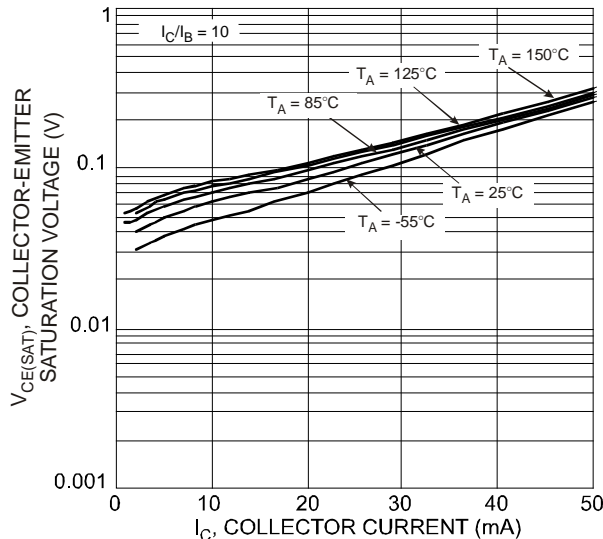

Fig. 4 Typical Collector-Emitter Saturation Voltage vs. Collector Current

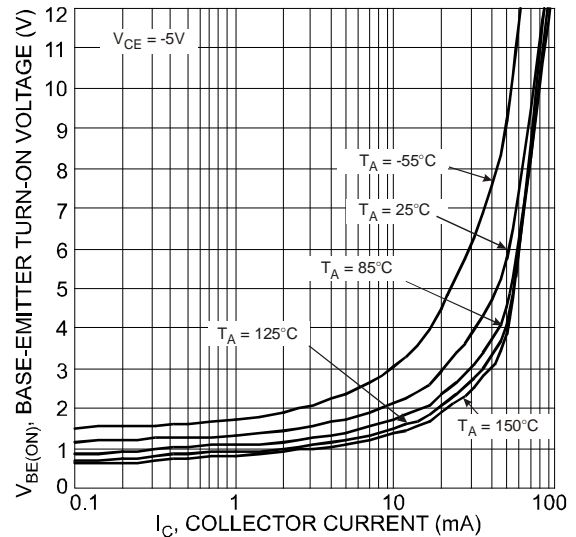

Fig. 5 Typical Base-Emitter Turn-On Voltage vs. Collector Current

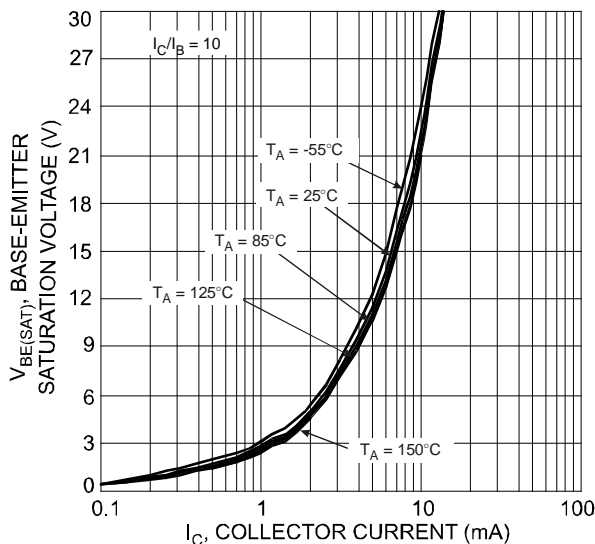

Fig. 6 Typical Base-Emitter Saturation Voltage vs. Collector Current

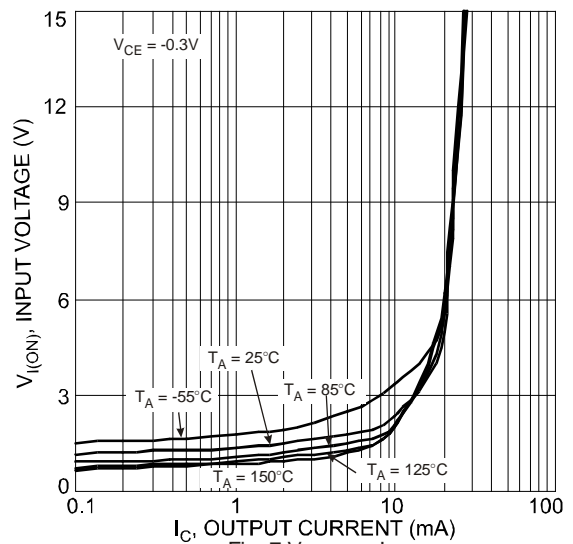

Fig. 7  $V_{I(ON)}$  vs.  $I_C$

**Typical Curves – DCX124EK NPN Section**

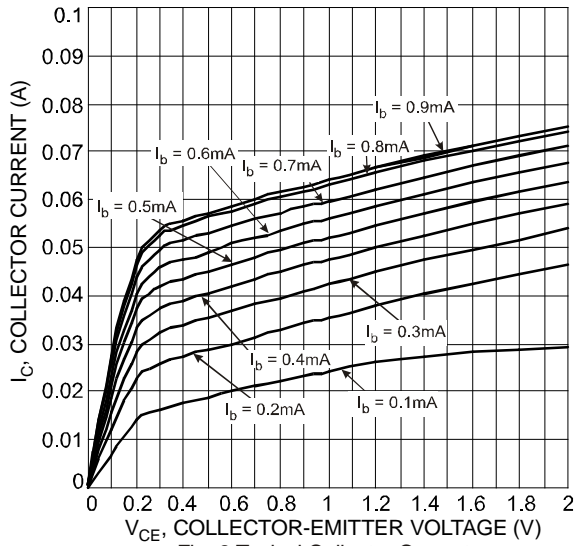

Fig. 8 Typical Collector Current vs. Collector-Emitter Voltage

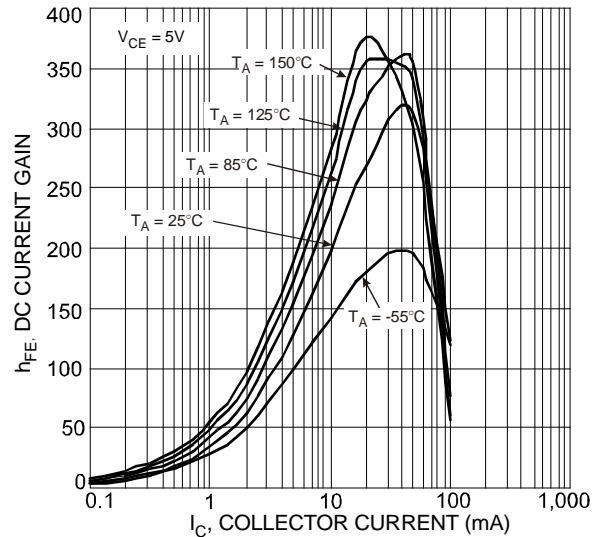

Fig. 9 Typical DC Current Gain vs. Collector Current

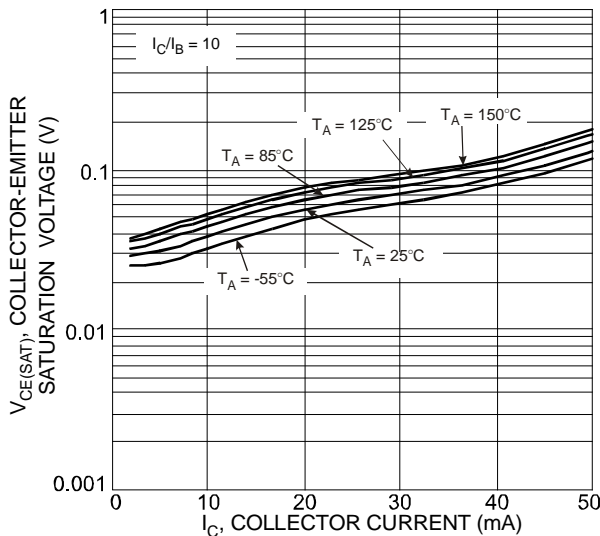

Fig. 10 Collector-Emitter Saturation Voltage vs. Collector Current

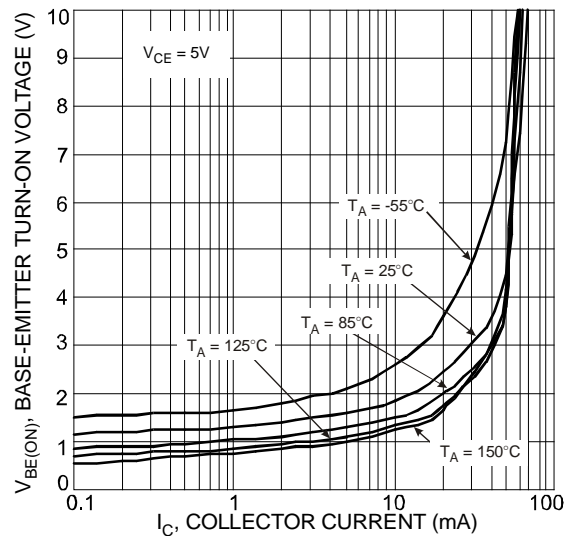

Fig. 11 Base-Emitter Turn-On Voltage vs. Collector Current

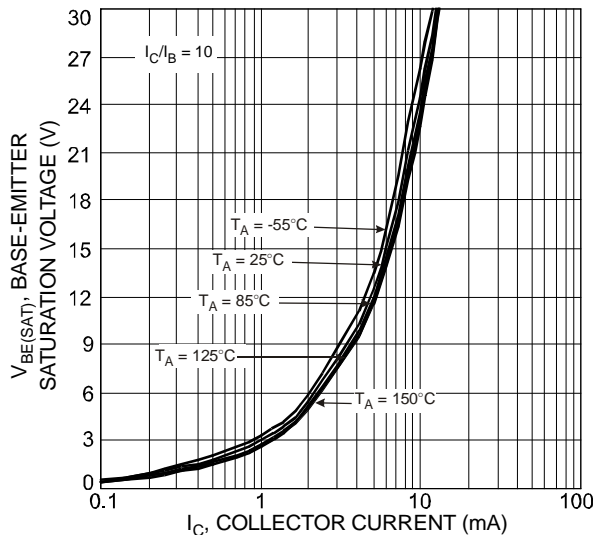

Fig. 12 Typical Base-Emitter Saturation Voltage vs. Collector Current

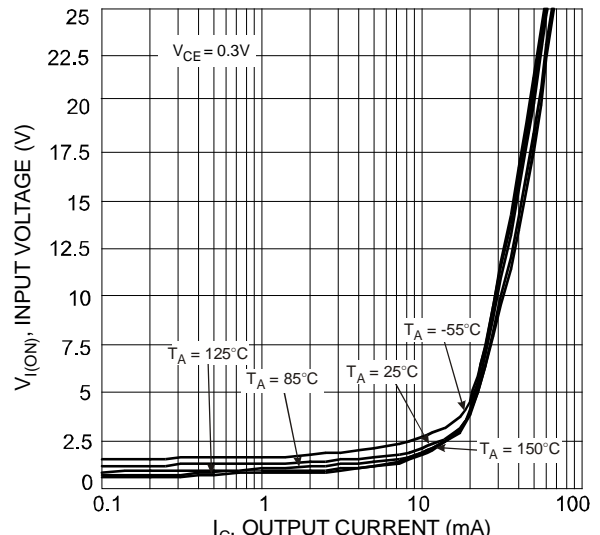

Fig. 13  $V_{I(ON)}$  vs.  $I_C$

Typical Curves – DCX123JK PNP Section

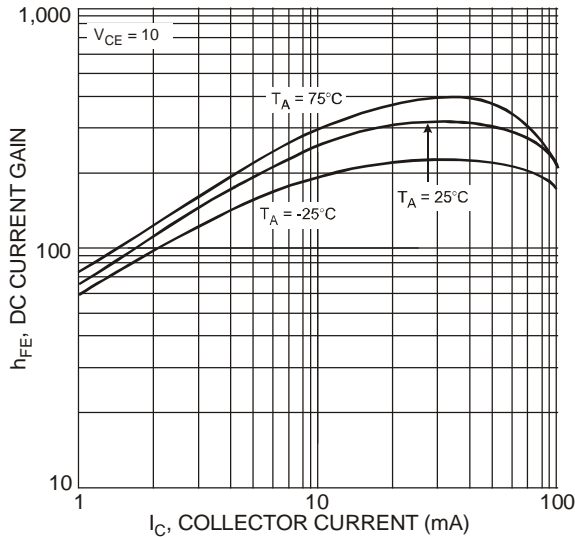

Fig. 14 Typical DC Current Gain vs. Collector Current

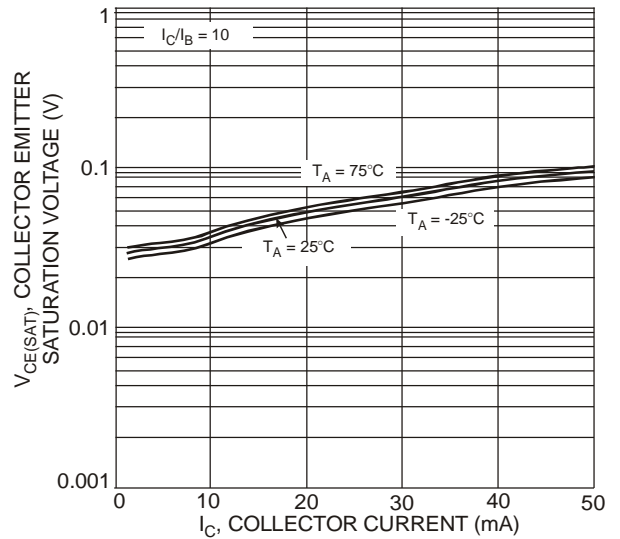

Fig. 15 Typical Collector Emitter Saturation Voltage vs. Collector Current

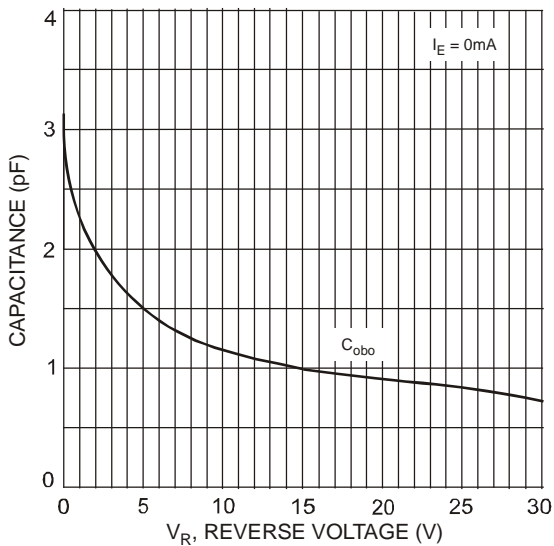

Fig. 16 Typical Capacitance Characteristics

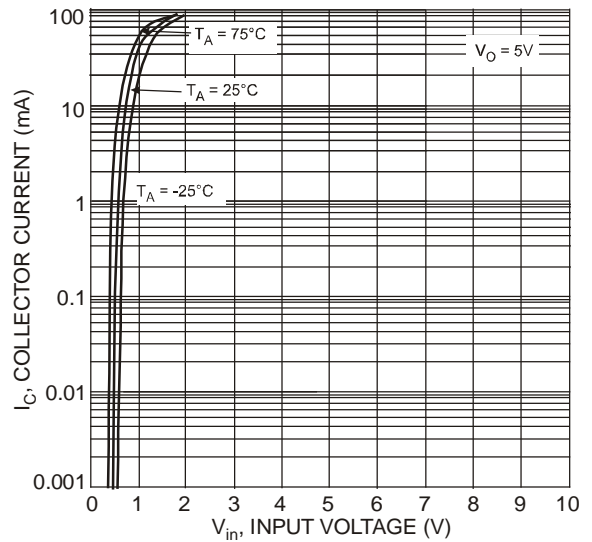

Fig. 17 Collector Current vs. Input Voltage

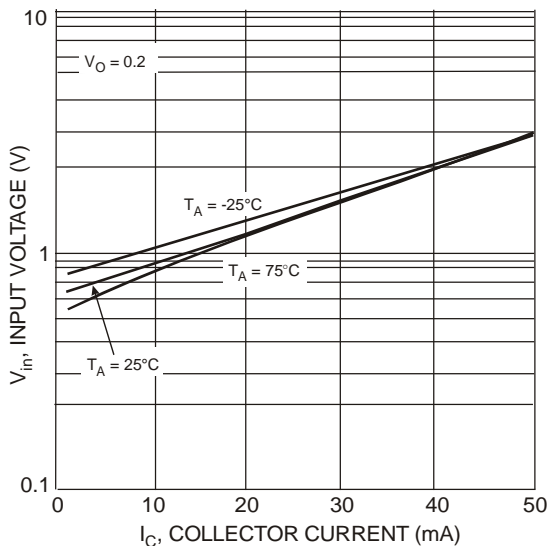

Fig. 18 Input Voltage vs. Collector Current

**Typical Curves – DCX123JK NPN Section**

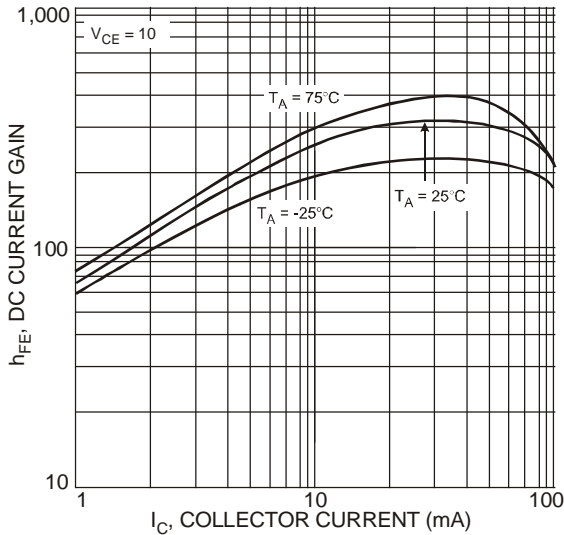

Fig. 19 Typical DC Current Gain vs. Collector Current

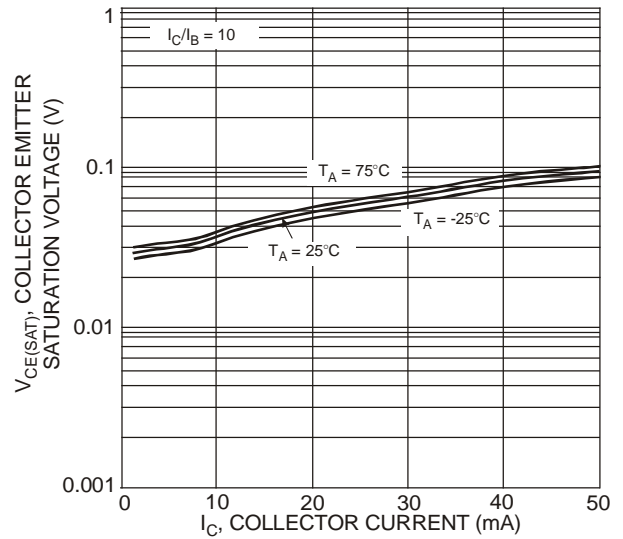

Fig. 20 Collector Emitter Saturation Voltage vs. Collector Current

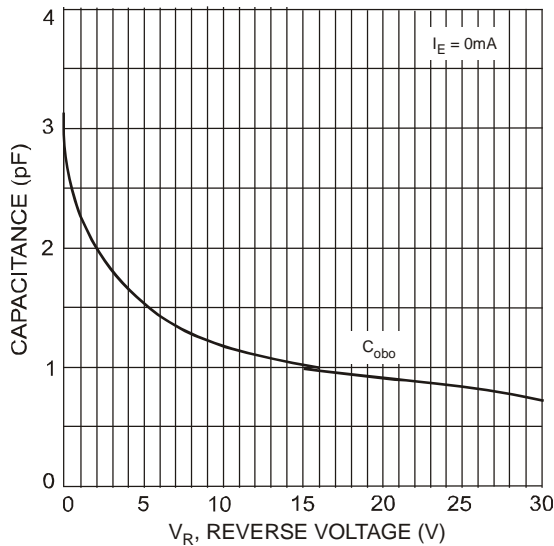

Fig. 21 Typical Capacitance Characteristics

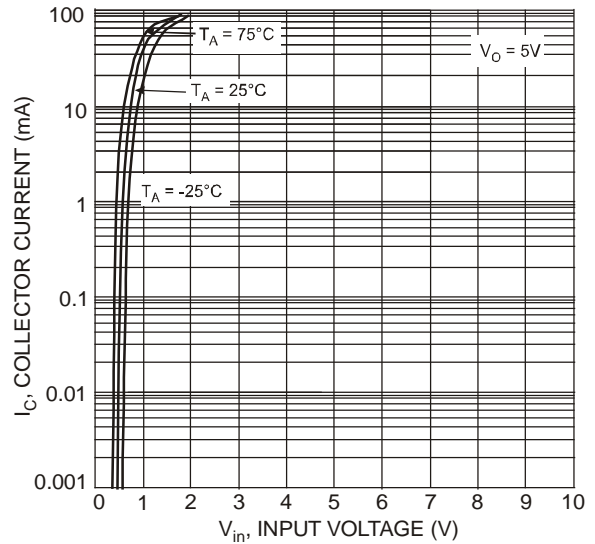

Fig. 22 Collector Current vs. Input Voltage

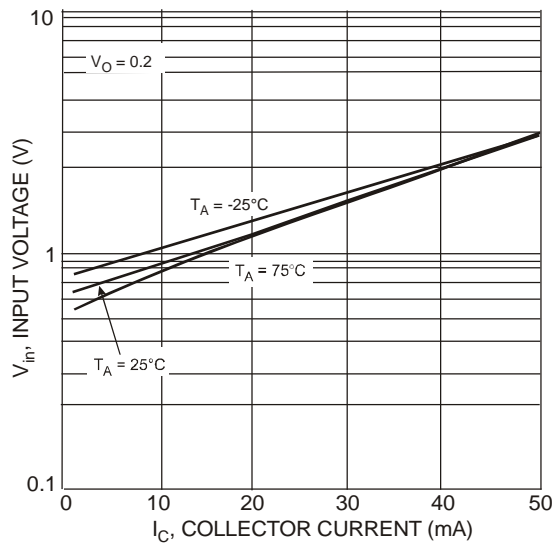

Fig. 23 Input Voltage vs. Collector Current



**Typical Curves – DCX114TK PNP Section**

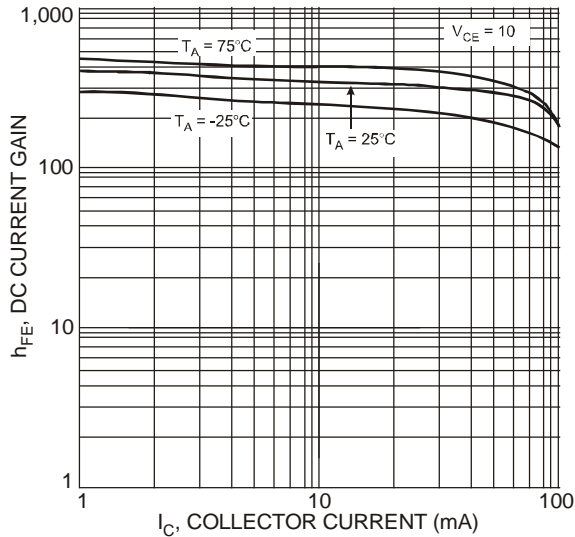

Fig. 24 Typical DC Current Gain vs. Collector Current

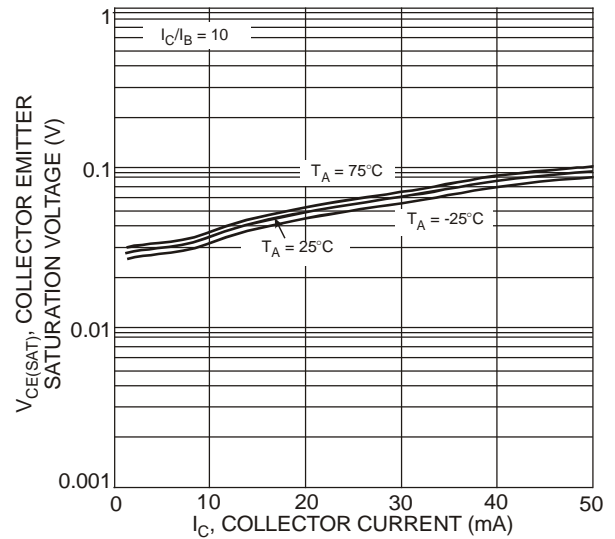

Fig. 25 Typical Collector Emitter Saturation Voltage vs. Collector Current

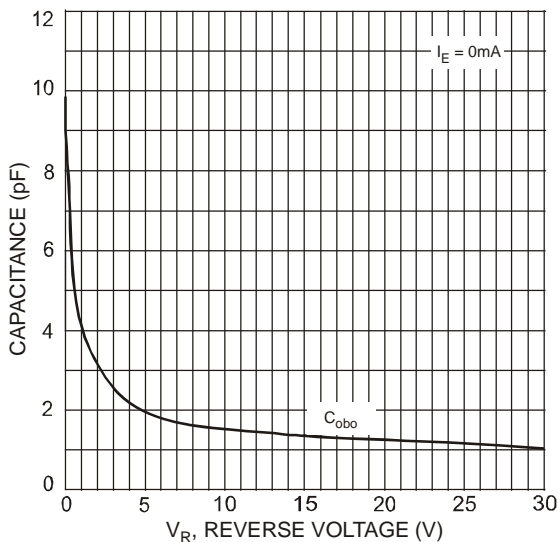

Fig. 26 Typical Capacitance Characteristics

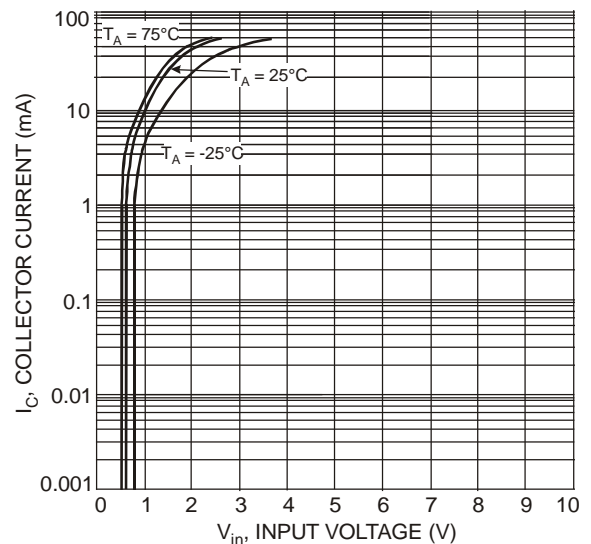

Fig. 27 Collector Current vs. Input Voltage

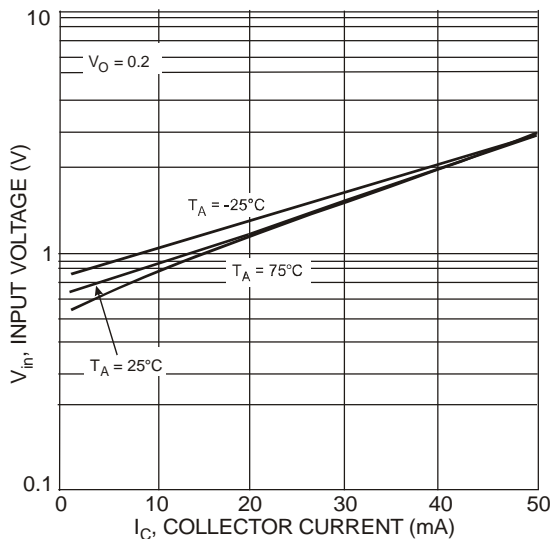

Fig. 28 Input Voltage vs. Collector Current

**Typical Curves- DCX114TK NPN Section**

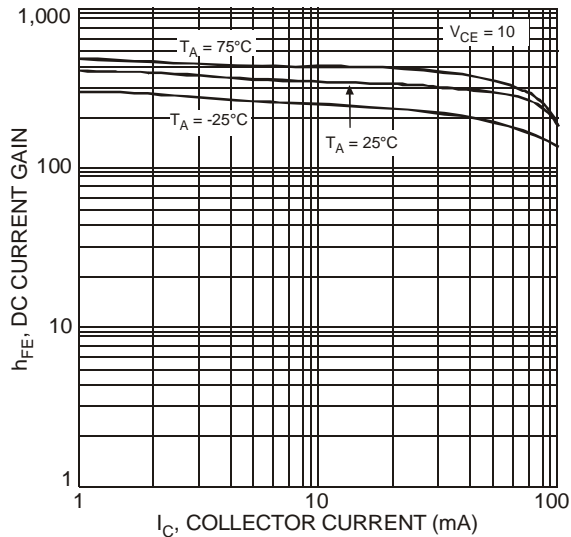

Fig. 29 Typical DC Current Gain vs. Collector Current

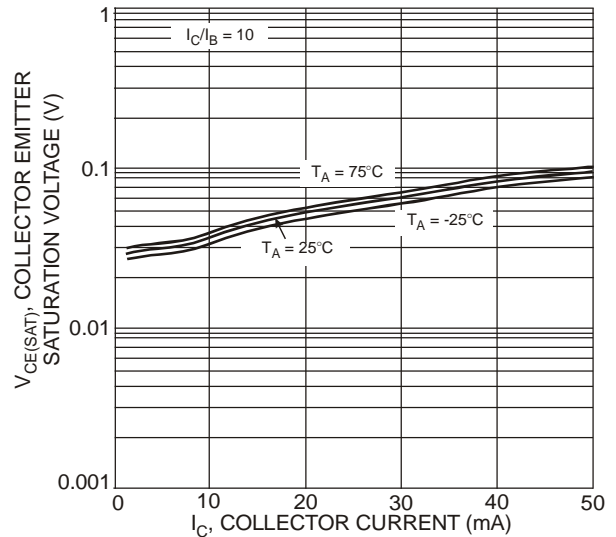

Fig. 30 Typical Collector Emitter Saturation Voltage vs. Collector Current

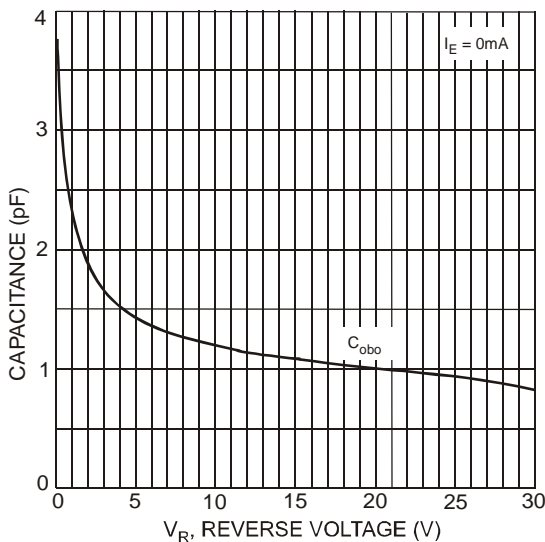

Fig. 31 Typical Capacitance Characteristics

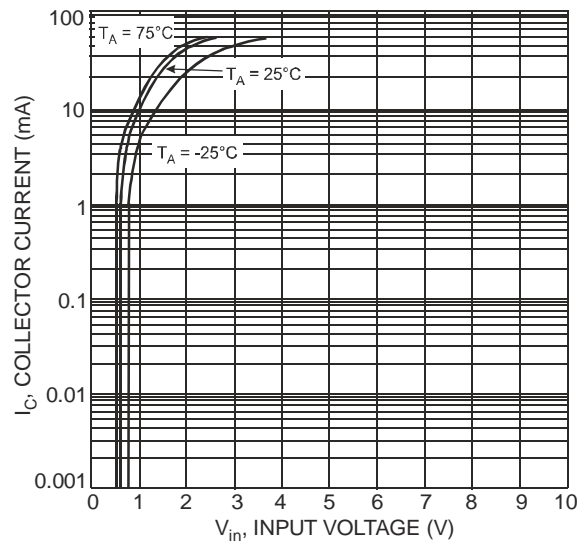

Fig. 32 Collector Current vs. Input Voltage

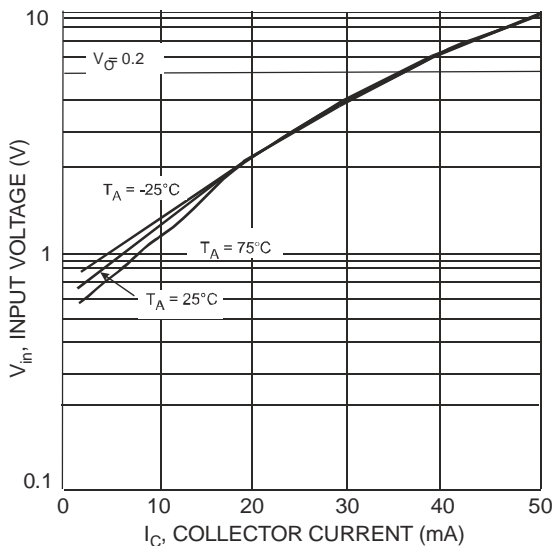

Fig. 33 Input Voltage vs. Collector Current

### Ordering Information (Notes 5 & 6)

Part Number	Case	Packaging
DCX124EK-7	SC-74R	3000/Tape & Reel
DCX144EK-7	SC-74R	3000/Tape & Reel
DCX114YK-7	SC-74R	3000/Tape & Reel
DCX123JK-7	SC-74R	3000/Tape & Reel
DCX114EK-7	SC-74R	3000/Tape & Reel
DCX115EK-7	SC-74R	3000/Tape & Reel
DCX143TK-7	SC-74R	3000/Tape & Reel
DCX114TK-7	SC-74R	3000/Tape & Reel

- Notes: 5. For packaging details, go to our website at <http://www.diodes.com/datasheets/ap02007.pdf>.  
 6. For Lead Free/RoHS Compliant version part numbers, please add "-F" suffix to the part numbers above. Example: DCX114TK-7-F.

### Marking Information

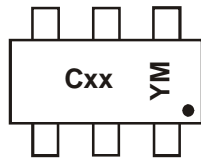

Cxx = Product Type Marking Code (See Page 1)  
 YM = Date Code Marking  
 Y = Year (ex: T = 2006)  
 M = Month (ex: 9 = September)

#### Date Code Key

Year	2006	2007	2008	2009	2010	2011	2012	2013	2014	2015
Code	T	U	V	W	X	Y	Z	A	B	C

Month	Jan	Feb	Mar	Apr	May	Jun	Jul	Aug	Sep	Oct	Nov	Dec
Code	1	2	3	4	5	6	7	8	9	O	N	D

### Package Outline Dimensions

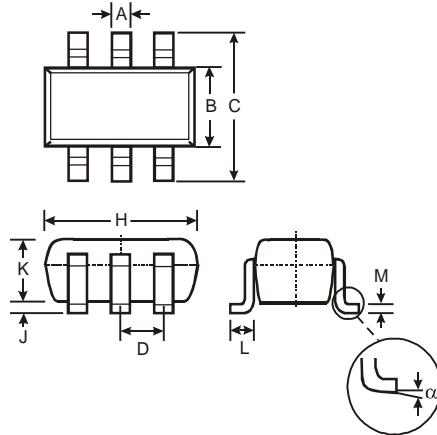

SC-74R			
Dim	Min	Max	Typ
A	0.35	0.50	0.38
B	1.50	1.70	1.60
C	2.70	3.00	2.80
D	—	—	0.95
H	2.90	3.10	3.00
J	0.013	0.10	0.05
K	1.00	1.30	1.10
L	0.35	0.55	0.40
M	0.10	0.20	0.15
$\alpha$	0°	8°	—
All Dimensions in mm			

### Suggested Pad Layout

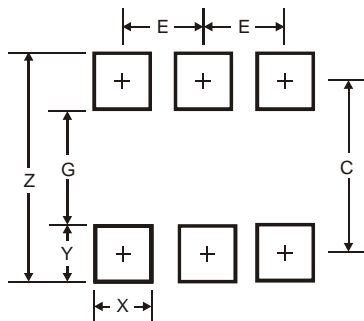

Dimensions	Value (in mm)
Z	3.20
G	1.60
X	0.55
Y	0.80
C	2.40
E	0.95

**IMPORTANT NOTICE**

Diodes Incorporated and its subsidiaries reserve the right to make modifications, enhancements, improvements, corrections or other changes without further notice to any product herein. Diodes Incorporated does not assume any liability arising out of the application or use of any product described herein; neither does it convey any license under its patent rights, nor the rights of others. The user of products in such applications shall assume all risks of such use and will agree to hold Diodes Incorporated and all the companies whose products are represented on our website, harmless against all damages.

**LIFE SUPPORT**

Diodes Incorporated products are not authorized for use as critical components in life support devices or systems without the expressed written approval of the President of Diodes Incorporated.

Компания «Океан Электроники» предлагает заключение долгосрочных отношений при поставках импортных электронных компонентов на взаимовыгодных условиях!

Наши преимущества:

- Поставка оригинальных импортных электронных компонентов напрямую с производств Америки, Европы и Азии, а так же с крупнейших складов мира;
- Широкая линейка поставок активных и пассивных импортных электронных компонентов (более 30 млн. наименований);
- Поставка сложных, дефицитных, либо снятых с производства позиций;
- Оперативные сроки поставки под заказ (от 5 рабочих дней);
- Экспресс доставка в любую точку России;
- Помощь Конструкторского Отдела и консультации квалифицированных инженеров;
- Техническая поддержка проекта, помощь в подборе аналогов, поставка прототипов;
- Поставка электронных компонентов под контролем ВП;
- Система менеджмента качества сертифицирована по Международному стандарту ISO 9001;
- При необходимости вся продукция военного и аэрокосмического назначения проходит испытания и сертификацию в лаборатории (по согласованию с заказчиком);
- Поставка специализированных компонентов военного и аэрокосмического уровня качества (Xilinx, Altera, Analog Devices, Intersil, Interpoint, Microsemi, Actel, Aeroflex, Peregrine, VPT, Syfer, Eurofarad, Texas Instruments, MS Kennedy, Miteq, Cobham, E2V, MA-COM, Hittite, Mini-Circuits, General Dynamics и др.);

Компания «Океан Электроники» является официальным дистрибьютором и эксклюзивным представителем в России одного из крупнейших производителей разъемов военного и аэрокосмического назначения «JONHON», а так же официальным дистрибьютором и эксклюзивным представителем в России производителя высокотехнологичных и надежных решений для передачи СВЧ сигналов «FORSTAR».



## JONHON

«JONHON» (основан в 1970 г.)

Разъемы специального, военного и аэрокосмического назначения:

(Применяются в военной, авиационной, аэрокосмической, морской, железнодорожной, горно- и нефтедобывающей отраслях промышленности)

«FORSTAR» (основан в 1998 г.)

ВЧ соединители, коаксиальные кабели, кабельные сборки и микроволновые компоненты:

(Применяются в телекоммуникациях гражданского и специального назначения, в средствах связи, РЛС, а так же военной, авиационной и аэрокосмической отраслях промышленности).



Телефон: 8 (812) 309-75-97 (многоканальный)

Факс: 8 (812) 320-03-32

Электронная почта: [ocean@oceanchips.ru](mailto:ocean@oceanchips.ru)

Web: <http://oceanchips.ru/>

Адрес: 198099, г. Санкт-Петербург, ул. Калинина, д. 2, корп. 4, лит. А