

DUAL COMPLEMENTARY PRE-BIASED TRANSISTOR
Features

- Epitaxial Planar Die Construction
- Built-In Biasing Resistors
- **Available in Lead Free/RoHS Compliant Version (Note 1)**
- **“Green” Device (Note 2)**

| Part Number | R1 | R2 | Marking |
|-------------|---------------|---------------|---------|
| DCX124EK | 22K Ω | 22K Ω | C17 |
| DCX144EK | 47K Ω | 47K Ω | C20 |
| DCX114YK | 10K Ω | 47K Ω | C14 |
| DCX123JK | 2.2K Ω | 47K Ω | C06 |
| DCX114EK | 10K Ω | 10K Ω | C13 |
| DCX115EK | 100K Ω | 100K Ω | C15 |
| DCX143TK | 4.7K Ω | - | C07 |
| DCX114TK | 10K Ω | - | C12 |

Mechanical Data

- Case: SC-74R (Note 3)
- Case Material: Molded Plastic, “Green” Molding Compound. UL Flammability Classification Rating 94V-0
- Moisture Sensitivity: Level 1 per J-STD-020D
- Terminals: Matte Tin Finish annealed over Copper leadframe (Lead Free Plating) Solderable per MIL-STD-202, Method 208
- Terminal Connections: See Diagram
- Marking Information: See Table and Page 11
- Ordering Information: See Page 11
- Weight: 0.015 grams (approximate)

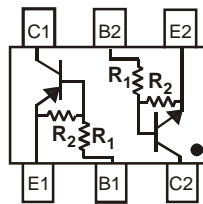

R1, R2 Device Schematic

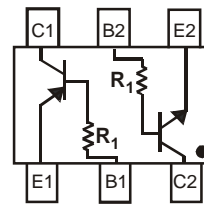

R1 only Device Schematic

Maximum Ratings NPN Section @ $T_A = 25^\circ\text{C}$ unless otherwise specified

| Characteristic | Symbol | Value | Unit | |
|----------------|----------|--------------|------------|----|
| Supply Voltage | V_{CC} | 50 | V | |
| Input Voltage | V_{IN} | DCX124EK | -10 to +40 | |
| | | DCX144EK | -10 to +40 | |
| | | DCX114YK | -6 to +40 | |
| | | DCX123JK | -5 to +12 | |
| | | DCX114EK | -10 to +40 | |
| | | DCX115EK | -10 to +40 | |
| | | DCX143TK | -5V max | |
| | | DCX114TK | -5V max | |
| Output Current | I_O | DCX124EK | 30 | |
| | | DCX144EK | 30 | |
| | | DCX114YK | 70 | |
| | | DCX123JK | 100 | |
| | | DCX114EK | 50 | |
| | | DCX115EK | 20 | |
| | | DCX143TK | 100 | |
| DCX114TK | 100 | | | |
| Output Current | All | $I_{C(MAX)}$ | 100 | mA |

Thermal Characteristics NPN Section

| Characteristic | Symbol | Value | Unit |
|--|-----------------|-------------|--------------------|
| Power Dissipation (Total) (Note 4) | P_D | 300 | mW |
| Thermal Resistance, Junction to Ambient Air (Note 4) | $R_{\theta JA}$ | 417 | $^\circ\text{C/W}$ |
| Operating and Storage Temperature Range | T_J, T_{STG} | -55 to +150 | $^\circ\text{C}$ |

- Notes:
1. No purposefully added lead.
 2. Diodes Inc.'s "Green" policy can be found on our website at http://www.diodes.com/products/lead_free/index.php.
 3. SC-74R and SOT-26 have identical dimensions and the only difference is the location of the pin one indicator. Please see the individual device datasheets for exact details regarding the location of the pin one indicator.
 4. Mounted on FR4 PC Board with recommended pad layout at <http://www.diodes.com/datasheets/ap02001.pdf>. 200mW per element must not be exceeded.

Maximum Ratings PNP Section @T_A = 25°C unless otherwise specified

| Characteristic | Symbol | Value | Unit | |
|----------------|-----------------|----------------------|--------------------|----|
| Supply Voltage | V _{CC} | 50 | V | |
| Input Voltage | V _{IN} | DCX124EK | +10 to -40 | |
| | | DCX144EK | +10 to -40 | |
| | | DCX114YK | +6 to -40 | |
| | | DCX123JK | +5 to -12 | |
| | | DCX114EK | +10 to -40 | |
| | | DCX115EK | +10 to -40 | |
| | | DCX143TK DCX114TK | +5V max +5V max | |
| Output Current | I _O | DCX124EK | -30 | |
| | | DCX144EK | -30 | |
| | | DCX114YK | -70 | |
| | | DCX123JK | -100 | |
| | | DCX114EK | -50 | |
| | | DCX115EK | -20 | |
| | | DCX143TK DCX114TK | -100 -100 | |
| Output Current | All | I _{C(MAX)} | -100 | mA |

Thermal Characteristics PNP Section

| Characteristic | Symbol | Value | Unit |
|--|-----------------------------------|-------------|------|
| Power Dissipation (Total) (Note 4) | P _D | 300 | mW |
| Thermal Resistance, Junction to Ambient Air (Note 4) | R _{θJA} | 833 | °C/W |
| Operating and Storage Temperature Range | T _J , T _{STG} | -55 to +150 | °C |

Electrical Characteristics NPN Section @T_A = 25°C unless otherwise specified

| Characteristic (DDC143TK & DDC114TK only) | Symbol | Min | Typ | Max | Unit | Test Condition |
|--|----------------------|-----|-----|-----|------|---|
| Collector-Base Breakdown Voltage | BV _{CBO} | 50 | — | — | V | I _C = 50μA |
| Collector-Emitter Breakdown Voltage | BV _{CEO} | 50 | — | — | V | I _C = 1mA |
| Emitter-Base Breakdown Voltage | BV _{EBO} | 5 | — | — | V | I _E = 50μA |
| Collector Cutoff Current | I _{CBO} | — | — | 0.5 | μA | V _{CB} = 50V |
| Emitter Cutoff Current | I _{EBO} | — | — | 0.5 | μA | V _{EB} = 4V |
| Collector-Emitter Saturation Voltage | V _{CE(SAT)} | — | — | 0.3 | V | I _C /I _B = 2.5mA / 0.25mA – DCX143TK I _C /I _B = 1mA / 0.1mA – DCX114TK |
| DC Current Transfer Ratio | h _{FE} | 100 | 250 | 600 | — | I _C = 1mA, V _{CE} = 5V |
| Input Resistor (R ₁) Tolerance | ΔR ₁ | -30 | — | +30 | % | — |
| Gain-Bandwidth Product* | f _T | — | 250 | — | MHz | V _{CE} = 10V, I _E = -5mA, f = 100MHz |

* Transistor - For Reference Only

Electrical Characteristics NPN Section (continued) @T_A = 25°C unless otherwise specified

| Characteristic | | Symbol | Min | Typ | Max | Unit | Test Condition |
|--|--|--------------------------------|--|------------------------------------|---|--|--|
| Input Voltage | DCX124EK DCX144EK DCX114YK DCX123JK DCX114EK DCX115EK | V _{I(OFF)} | 0.5 0.5 0.3 0.5 0.5 0.5 | 1.1 1.1 — — 1.1 1.1 | — | V | V _{CC} = 5V, I _O = 100μA |
| | DCX124EK DCX144EK DCX114YK DCX123JK DCX114EK DCX115EK | | V _{I(ON)} | — | 1.65 1.9 — — 1.9 1.9 | 3.0 3.0 1.4 1.1 3.0 3.0 | V |
| Output Voltage | DCX124EK DCX144EK DCX114YK DCX123JK DCX114EK DCX115EK | V _{O(ON)} | | — | 0.1 | 0.3 | V |
| Input Current | DCX124EK DCX144EK DCX114YK DCX123JK DCX114EK DCX115EK | I _I | — | — | 0.36 0.18 0.88 3.6 0.88 0.15 | mA | V _I = 5V |
| Output Current | | I _{O(OFF)} | — | — | 0.5 | μA | V _{CC} = 50V, V _I = 0V |
| DC Current Gain | DCX124EK DCX144EK DCX114YK DCX123JK DCX114EK DCX115EK | G _I | 80 68 68 80 30 82 | — | — | — | V _O = 5V, I _O = 5mA V _O = 5V, I _O = 5mA V _O = 5V, I _O = 10mA V _O = 5V, I _O = 10mA V _O = 5V, I _O = 5mA V _O = 5V, I _O = 5mA |
| Input Resistor (R ₁) Tolerance | | ΔR ₁ | -30 | — | +30 | % | — |
| Resistance Ratio Tolerance | | R ₂ /R ₁ | -20 | — | +20 | % | — |
| Gain-Bandwidth Product* | | f _T | — | 250 | — | MHz | V _{CE} = 10V, I _E = -5mA, f = 100MHz |

* Transistor - For Reference Only

Electrical Characteristics PNP Section @T_A = 25°C unless otherwise specified

| Characteristic (DCX143TK & DCX114TK only) | | Symbol | Min | Typ | Max | Unit | Test Condition |
|--|--|----------------------|-----|-----|------|------|---|
| Collector-Base Breakdown Voltage | | BV _{CB0} | -50 | — | — | V | I _C = -50μA |
| Collector-Emitter Breakdown Voltage | | BV _{CEO} | -50 | — | — | V | I _C = -1mA |
| Emitter-Base Breakdown Voltage | | BV _{EBO} | -5 | — | — | V | I _E = -50μA |
| Collector Cutoff Current | | I _{CB0} | — | — | -0.5 | μA | V _{CB} = -50V |
| Emitter Cutoff Current | | I _{EBO} | — | — | -0.5 | μA | V _{EB} = -4V |
| Collector-Emitter Saturation Voltage | | V _{CE(SAT)} | — | — | -0.3 | V | I _C /I _B = -2.5mA / -0.25mA - DCX143TK I _C /I _B = -1mA / -0.1mA - DCX114TK |
| DC Current Transfer Ratio | | h _{FE} | 100 | 250 | 600 | — | I _C = -1mA, V _{CE} = -5V |
| Input Resistor (R ₁) Tolerance | | ΔR ₁ | -30 | — | +30 | % | — |
| Gain-Bandwidth Product* | | f _T | — | 250 | — | MHz | V _{CE} = -10V, I _E = 5mA, f = 100MHz |

* Transistor - For Reference Only

Electrical Characteristics PNP Section (Continued) @T_A = 25°C unless otherwise specified

| Characteristic | | Symbol | Min | Typ | Max | Unit | Test Condition |
|--|--|--------------------------------|--|--|---|------|--|
| Input Voltage | DCX124EK DCX144EK DCX114YK DCX123JK DCX114EK DCX115EK | V _{I(OFF)} | -0.5 -0.5 -0.3 -0.5 -0.5 -0.5 | -1.1 -1.1 — — -1.1 -1.1 | — | V | V _{CC} = -5V, I _O = -100μA |
| | DCX124EK DCX144EK DCX114YK DCX123JK DCX114EK DCX115EK | V _{I(ON)} | — | -1.9 — — — -1.9 -1.9 | -3.0 -3.0 -1.4 -1.1 -3.0 -3.0 | V | V _O = -0.3V, I _O = -5mA V _O = -0.3V, I _O = -2mA V _O = -0.3V, I _O = -1mA V _O = -0.3V, I _O = -5mA V _O = -0.3V, I _O = -10mA V _O = -0.3V, I _O = -1mA |
| Output Voltage | DCX124EK DCX144EK DCX114YK DCX123JK DCX114EK DCX115EK | V _{O(ON)} | — | -0.1 | -0.3 | V | I _O /I _I = -10mA / -0.5mA I _O /I _I = -10mA / -0.5mA I _O /I _I = -5mA / -0.25mA I _O /I _I = -5mA / -0.25mA I _O /I _I = -10mA / -0.5mA I _O /I _I = -5mA / -0.25mA |
| Input Current | DCX124EK DCX144EK DCX114YK DCX123JK DCX114EK DCX115EK | I _I | — | — | -0.36 -0.18 -0.88 -3.6 -0.88 -0.15 | mA | V _I = -5V |
| Output Current | | I _{O(OFF)} | — | — | -0.5 | μA | V _{CC} = 50V, V _I = 0V |
| DC Current Gain | DCX124EK DCX144EK DCX114YK DCX123JK DCX114EK DCX115EK | G _I | 80 68 68 80 30 82 | — | — | — | V _O = -5V, I _O = -5mA V _O = -5V, I _O = -5mA V _O = -5V, I _O = -10mA V _O = -5V, I _O = -10mA V _O = -5V, I _O = -5mA V _O = -5V, I _O = -5mA |
| Input Resistor (R ₁) Tolerance | | ΔR ₁ | -30 | — | +30 | % | — |
| Resistance Ratio Tolerance | | R ₂ /R ₁ | -20 | — | +20 | % | — |
| Gain-Bandwidth Product* | | f _T | — | 250 | — | MHZ | V _{CE} = -10V, I _E = -5mA, f = 100MHZ |

*Transistor - For Reference Only

Typical Curves – Total Device

Fig. 1 Power Dissipation vs. Ambient Temperature

Typical Curves – DCX124EK PNP Section



Fig. 2 Typical Collector Current vs. Collector-Emitter Voltage

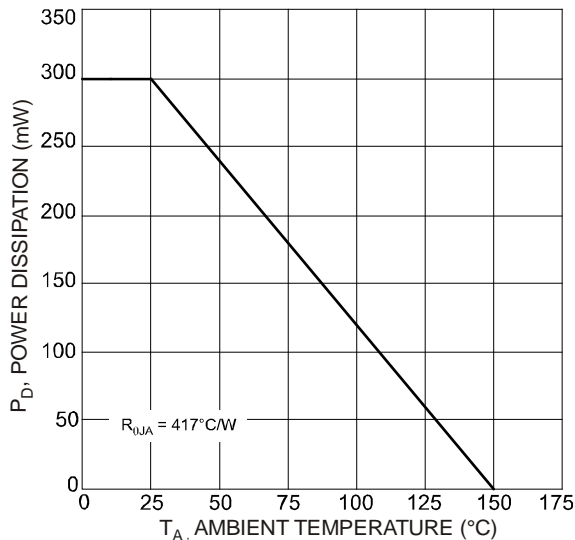

Fig. 3 Typical DC Current Gain vs. Collector Current

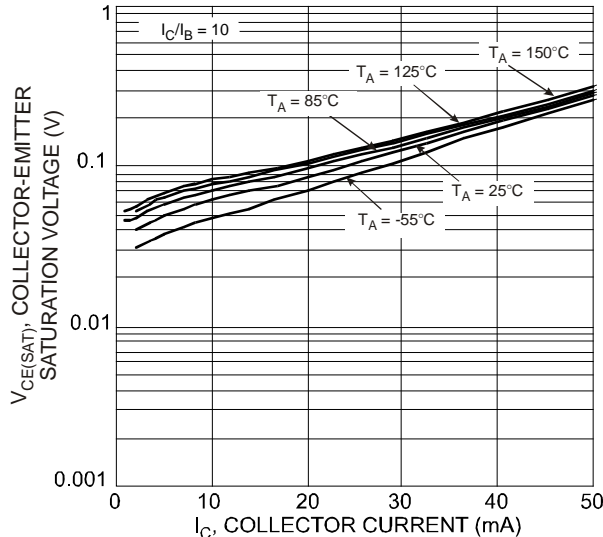

Fig. 4 Typical Collector-Emitter Saturation Voltage vs. Collector Current

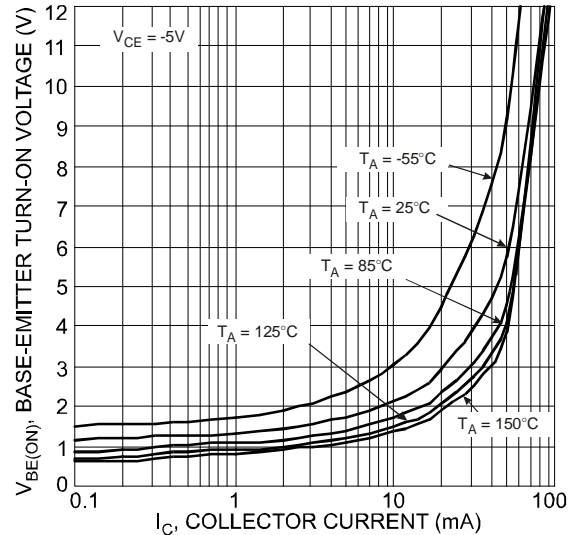

Fig. 5 Typical Base-Emitter Turn-On Voltage vs. Collector Current

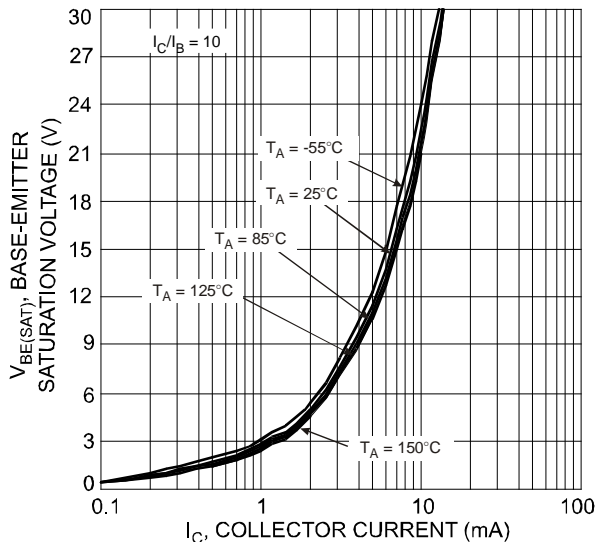

Fig. 6 Typical Base-Emitter Saturation Voltage vs. Collector Current

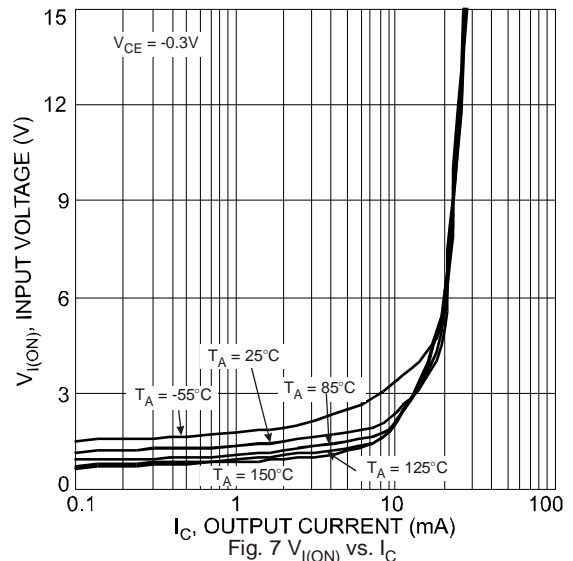

Fig. 7 $V_{I(ON)}$ vs. I_C

Typical Curves – DCX124EK NPN Section



Fig. 8 Typical Collector Current vs. Collector-Emitter Voltage

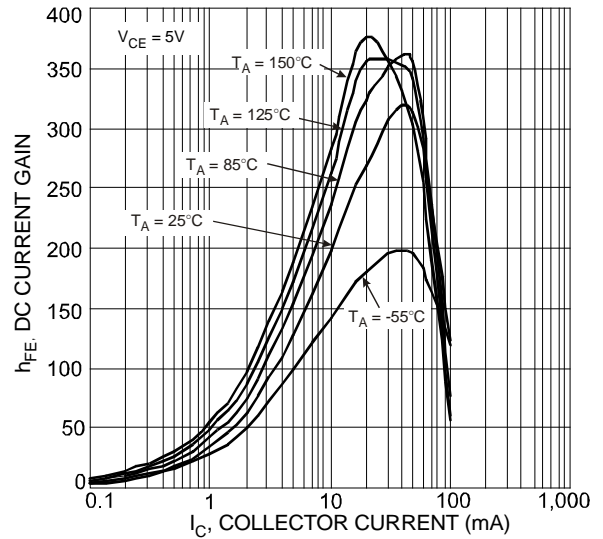

Fig. 9 Typical DC Current Gain vs. Collector Current

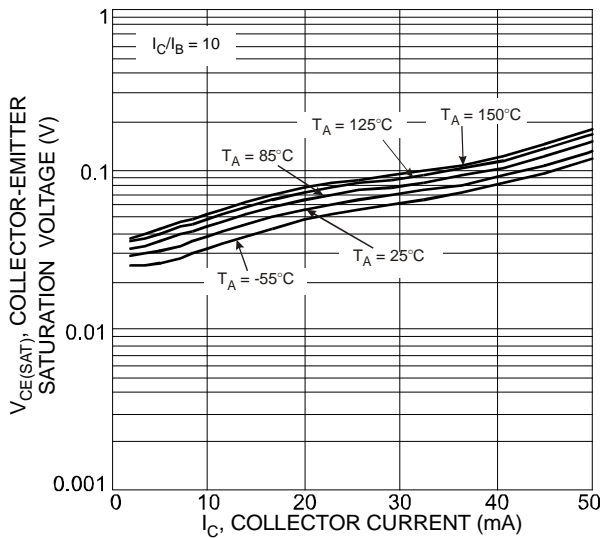

Fig. 10 Collector-Emitter Saturation Voltage vs. Collector Current

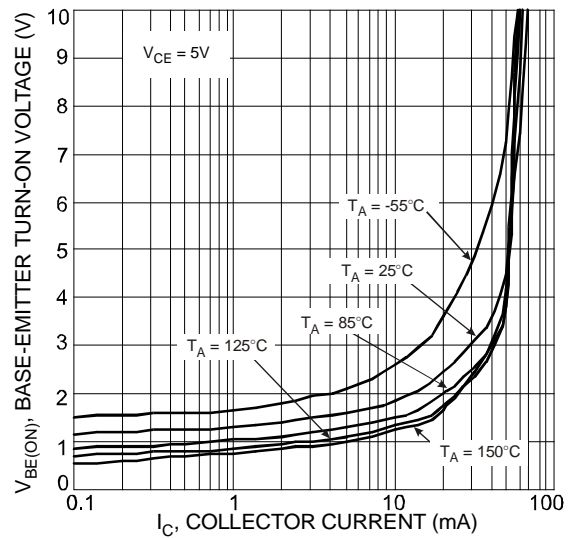

Fig. 11 Base-Emitter Turn-On Voltage vs. Collector Current

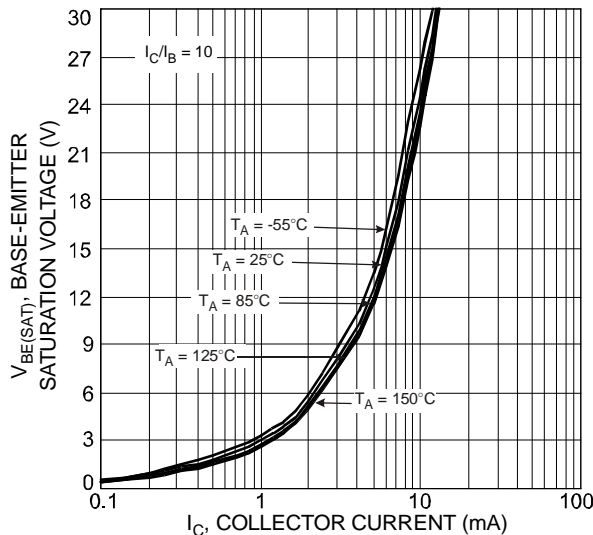

Fig. 12 Typical Base-Emitter Saturation Voltage vs. Collector Current

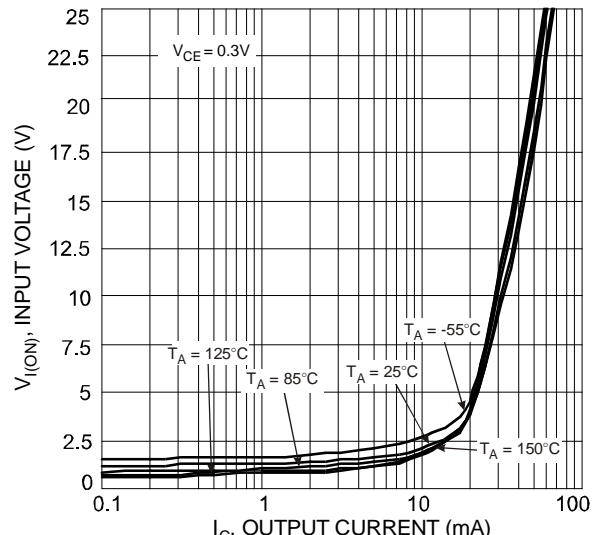

Fig. 13 $V_{BE(ON)}$ vs. I_C

Typical Curves – DCX123JK PNP Section



Fig. 14 Typical DC Current Gain vs. Collector Current



Fig. 15 Typical Collector Emitter Saturation Voltage vs. Collector Current

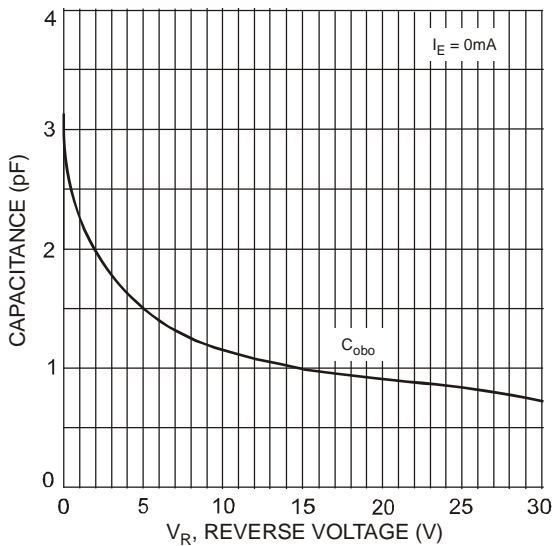

Fig. 16 Typical Capacitance Characteristics

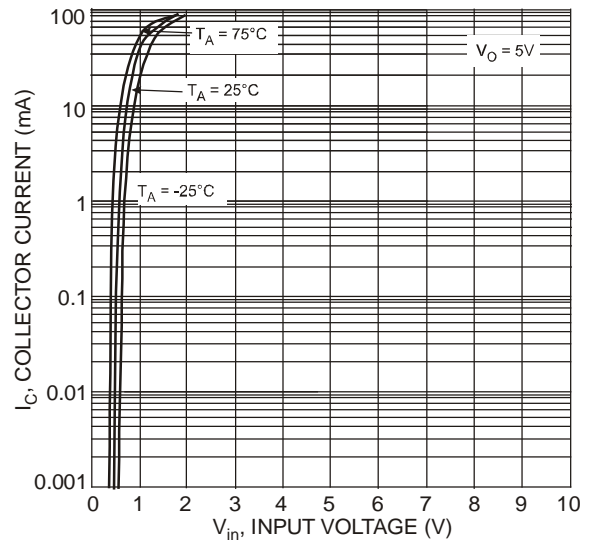

Fig. 17 Collector Current vs. Input Voltage



Fig. 18 Input Voltage vs. Collector Current

Typical Curves – DCX123JK NPN Section



Fig. 19 Typical DC Current Gain vs. Collector Current

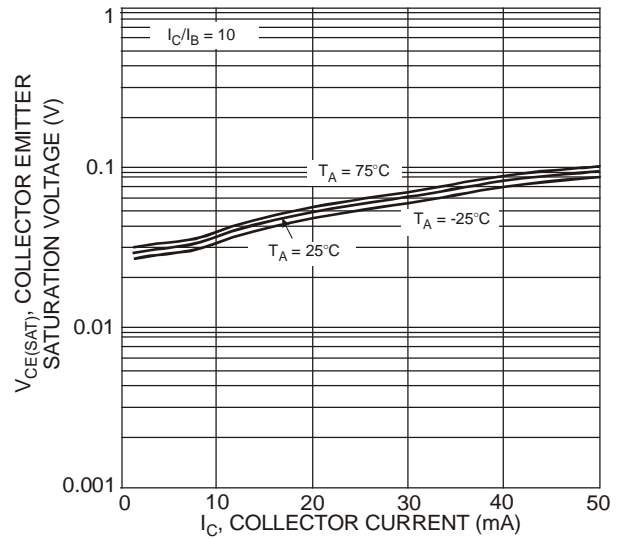

Fig. 20 Collector Emitter Saturation Voltage vs. Collector Current

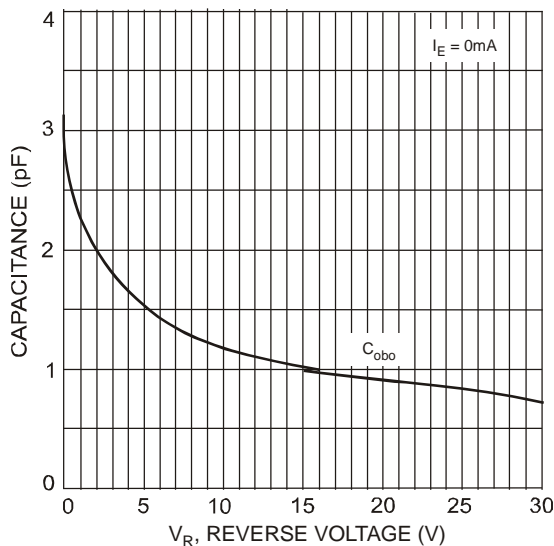

Fig. 21 Typical Capacitance Characteristics

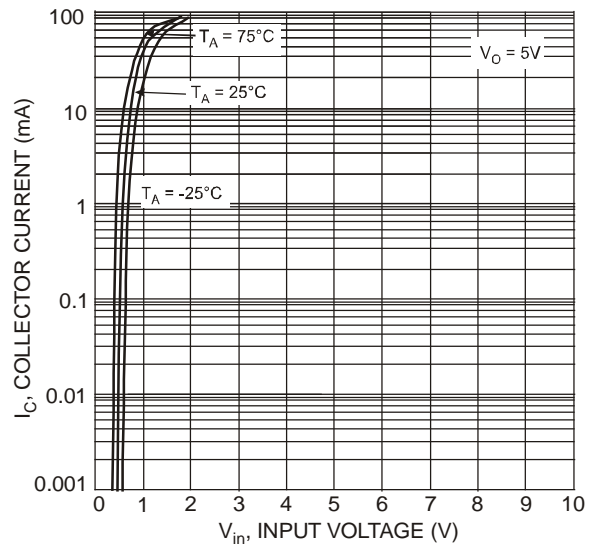

Fig. 22 Collector Current vs. Input Voltage

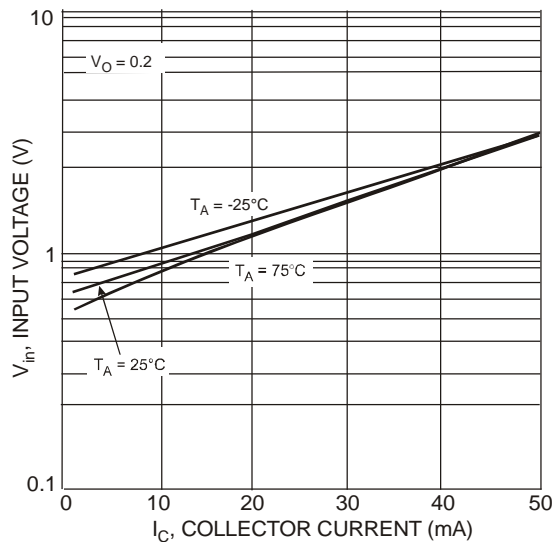

Fig. 23 Input Voltage vs. Collector Current

Typical Curves – DCX114TK PNP Section



Fig. 24 Typical DC Current Gain vs. Collector Current



Fig. 25 Typical Collector Emitter Saturation Voltage vs. Collector Current



Fig. 26 Typical Capacitance Characteristics



Fig. 27 Collector Current vs. Input Voltage



Fig. 28 Input Voltage vs. Collector Current

Typical Curves- DCX114TK NPN Section

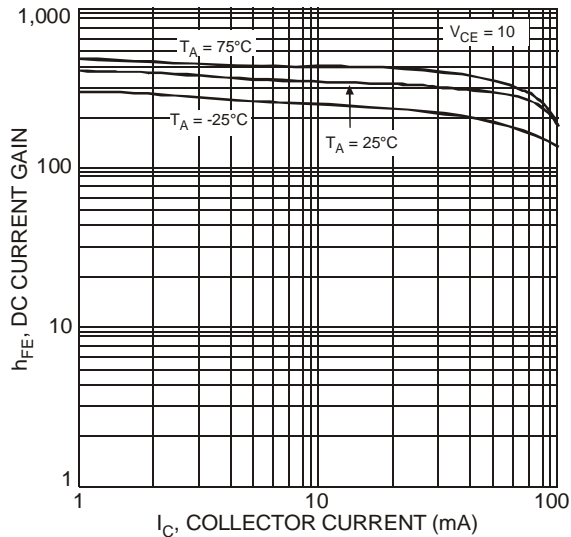

Fig. 29 Typical DC Current Gain vs. Collector Current

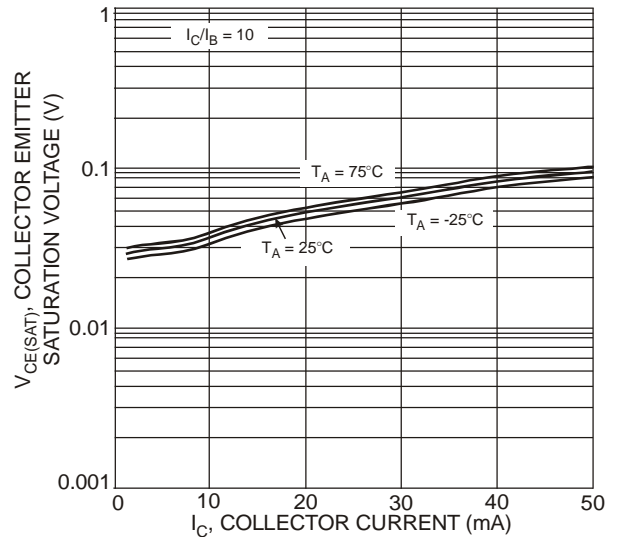

Fig. 30 Typical Collector Emitter Saturation Voltage vs. Collector Current



Fig. 31 Typical Capacitance Characteristics

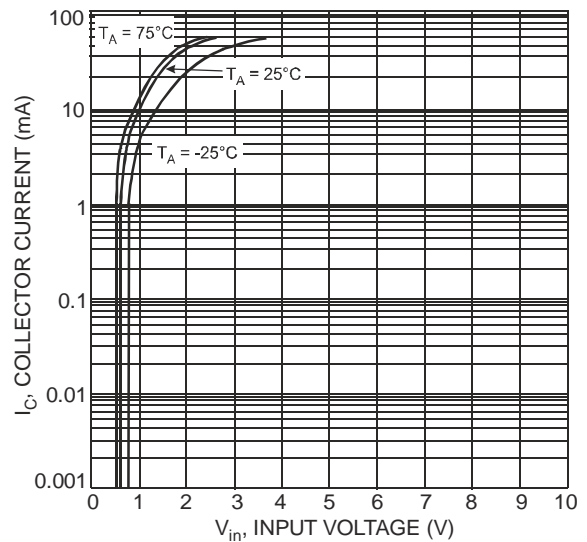

Fig. 32 Collector Current vs. Input Voltage

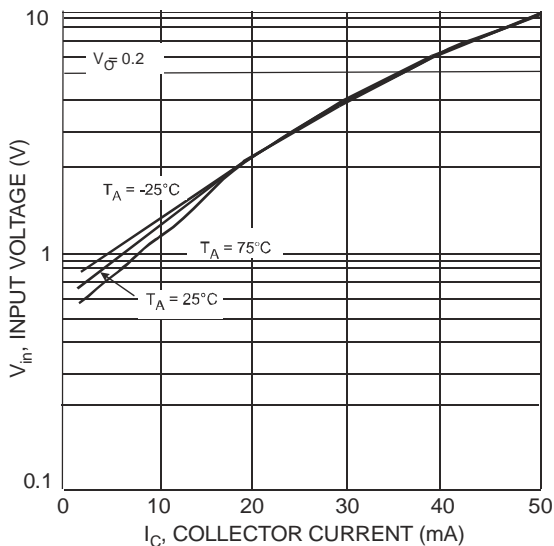

Fig. 33 Input Voltage vs. Collector Current

Ordering Information (Notes 5 & 6)

| Part Number | Case | Packaging |
|-------------|--------|------------------|
| DCX124EK-7 | SC-74R | 3000/Tape & Reel |
| DCX144EK-7 | SC-74R | 3000/Tape & Reel |
| DCX114YK-7 | SC-74R | 3000/Tape & Reel |
| DCX123JK-7 | SC-74R | 3000/Tape & Reel |
| DCX114EK-7 | SC-74R | 3000/Tape & Reel |
| DCX115EK-7 | SC-74R | 3000/Tape & Reel |
| DCX143TK-7 | SC-74R | 3000/Tape & Reel |
| DCX114TK-7 | SC-74R | 3000/Tape & Reel |

- Notes: 5. For packaging details, go to our website at <http://www.diodes.com/datasheets/ap02007.pdf>.
 6. For Lead Free/RoHS Compliant version part numbers, please add "-F" suffix to the part numbers above. Example: DCX114TK-7-F.

Marking Information



Cxx = Product Type Marking Code (See Page 1)
 YM = Date Code Marking
 Y = Year (ex: T = 2006)
 M = Month (ex: 9 = September)

Date Code Key

| Year | 2006 | 2007 | 2008 | 2009 | 2010 | 2011 | 2012 | 2013 | 2014 | 2015 |
|------|------|------|------|------|------|------|------|------|------|------|
| Code | T | U | V | W | X | Y | Z | A | B | C |

| Month | Jan | Feb | Mar | Apr | May | Jun | Jul | Aug | Sep | Oct | Nov | Dec |
|-------|-----|-----|-----|-----|-----|-----|-----|-----|-----|-----|-----|-----|
| Code | 1 | 2 | 3 | 4 | 5 | 6 | 7 | 8 | 9 | O | N | D |

Package Outline Dimensions



| SC-74R | | | |
|----------------------|-------|------|------|
| Dim | Min | Max | Typ |
| A | 0.35 | 0.50 | 0.38 |
| B | 1.50 | 1.70 | 1.60 |
| C | 2.70 | 3.00 | 2.80 |
| D | — | — | 0.95 |
| H | 2.90 | 3.10 | 3.00 |
| J | 0.013 | 0.10 | 0.05 |
| K | 1.00 | 1.30 | 1.10 |
| L | 0.35 | 0.55 | 0.40 |
| M | 0.10 | 0.20 | 0.15 |
| α | 0° | 8° | — |
| All Dimensions in mm | | | |

Suggested Pad Layout



| Dimensions | Value (in mm) |
|------------|---------------|
| Z | 3.20 |
| G | 1.60 |
| X | 0.55 |
| Y | 0.80 |
| C | 2.40 |
| E | 0.95 |

IMPORTANT NOTICE

Diodes Incorporated and its subsidiaries reserve the right to make modifications, enhancements, improvements, corrections or other changes without further notice to any product herein. Diodes Incorporated does not assume any liability arising out of the application or use of any product described herein; neither does it convey any license under its patent rights, nor the rights of others. The user of products in such applications shall assume all risks of such use and will agree to hold Diodes Incorporated and all the companies whose products are represented on our website, harmless against all damages.

LIFE SUPPORT

Diodes Incorporated products are not authorized for use as critical components in life support devices or systems without the expressed written approval of the President of Diodes Incorporated.

Компания «Океан Электроники» предлагает заключение долгосрочных отношений при поставках импортных электронных компонентов на взаимовыгодных условиях!

Наши преимущества:

- Поставка оригинальных импортных электронных компонентов напрямую с производств Америки, Европы и Азии, а так же с крупнейших складов мира;
- Широкая линейка поставок активных и пассивных импортных электронных компонентов (более 30 млн. наименований);
- Поставка сложных, дефицитных, либо снятых с производства позиций;
- Оперативные сроки поставки под заказ (от 5 рабочих дней);
- Экспресс доставка в любую точку России;
- Помощь Конструкторского Отдела и консультации квалифицированных инженеров;
- Техническая поддержка проекта, помощь в подборе аналогов, поставка прототипов;
- Поставка электронных компонентов под контролем ВП;
- Система менеджмента качества сертифицирована по Международному стандарту ISO 9001;
- При необходимости вся продукция военного и аэрокосмического назначения проходит испытания и сертификацию в лаборатории (по согласованию с заказчиком);
- Поставка специализированных компонентов военного и аэрокосмического уровня качества (Xilinx, Altera, Analog Devices, Intersil, Interpoint, Microsemi, Actel, Aeroflex, Peregrine, VPT, Syfer, Eurofarad, Texas Instruments, MS Kennedy, Miteq, Cobham, E2V, MA-COM, Hittite, Mini-Circuits, General Dynamics и др.);

Компания «Океан Электроники» является официальным дистрибьютором и эксклюзивным представителем в России одного из крупнейших производителей разъемов военного и аэрокосмического назначения «JONHON», а так же официальным дистрибьютором и эксклюзивным представителем в России производителя высокотехнологичных и надежных решений для передачи СВЧ сигналов «FORSTAR».



JONHON

«JONHON» (основан в 1970 г.)

Разъемы специального, военного и аэрокосмического назначения:

(Применяются в военной, авиационной, аэрокосмической, морской, железнодорожной, горно- и нефтедобывающей отраслях промышленности)

«FORSTAR» (основан в 1998 г.)

ВЧ соединители, коаксиальные кабели, кабельные сборки и микроволновые компоненты:

(Применяются в телекоммуникациях гражданского и специального назначения, в средствах связи, РЛС, а так же военной, авиационной и аэрокосмической отраслях промышленности).



Телефон: 8 (812) 309-75-97 (многоканальный)

Факс: 8 (812) 320-03-32

Электронная почта: ocean@oceanchips.ru

Web: <http://oceanchips.ru/>

Адрес: 198099, г. Санкт-Петербург, ул. Калинина, д. 2, корп. 4, лит. А