

3-PHASE BRIDGE DRIVER

Features

- Floating channel designed for bootstrap operation
 Fully operational to +600V
 Tolerant to negative transient voltage - dV/dt immune
- Gate drive supply range from 12 to 20V
- Undervoltage lockout for all channels
- Over-current shutdown turns off all six drivers
- Independent 3 half-bridge drivers
- Matched propagation delay for all channels
- Cross-conduction prevention logic
- Lowside outputs out of phase with inputs. High side outputs out of phase
- 3.3V logic compatible
- Lower di/dt gate driver for better noise immunity
- Externally programmable delay for automatic fault clear

Packages

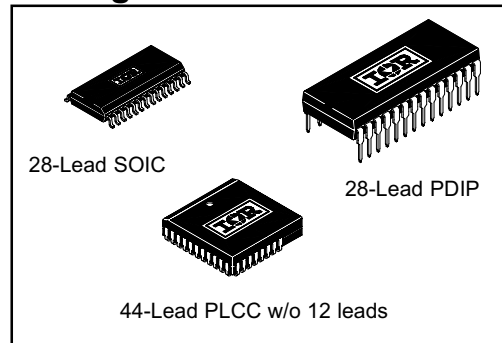

Description

The IR21363(J&S) are high voltage, high speed power MOSFET and IGBT drivers with three independent high and low side referenced output channels for 3-phase applications. Proprietary HVIC technology enables ruggedized monolithic construction. Logic inputs are compatible with CMOS or LSTTL outputs, down to 3.3V logic. A current trip function which terminates all six outputs can be derived from an external current sense resistor. An enable function is available to terminate all six outputs simultaneously. An open-drain FAULT signal is provided to indicate that an overcurrent or undervoltage shutdown has occurred. Overcurrent fault conditions are cleared automatically after a delay programmed externally via an RC network connected to the RCIN input. The output drivers feature a high pulse current buffer stage designed for minimum driver cross-conduction. Propagation delays are matched to simplify use in high frequency applications. The floating channel can be used to drive N-channel power MOSFETs or IGBTs in the high side configuration which operates up to 600 volts.

Typical Connection

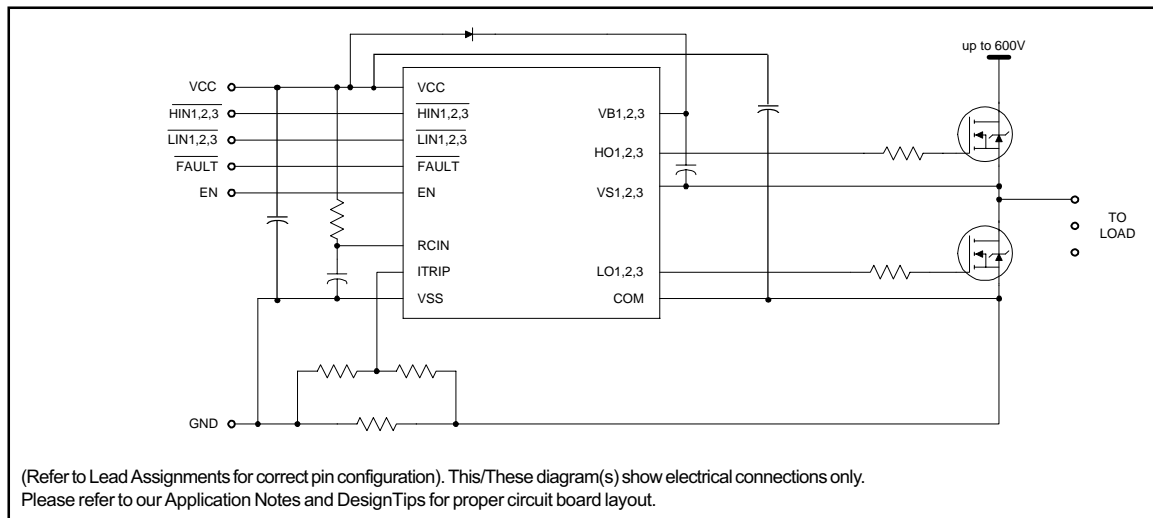

Absolute Maximum Ratings

Absolute maximum ratings indicate sustained limits beyond which damage to the device may occur. All voltage parameters are absolute voltages referenced to COM. The thermal resistance and power dissipation ratings are measured under board mounted and still air conditions.

Symbol	Definition	Min.	Max.	Units	
V _S	High side offset voltage	V _{B1,2,3} - 25	V _{B1,2,3} + 0.3	V	
V _{BS}	High side floating supply voltage	-0.3	625		
V _{HO}	High side floating output voltage	V _{S1,2,3} - 0.3	V _{B1,2,3} + 0.3		
V _{CC}	Low side and logic fixed supply voltage	-0.3	25		
V _{SS}	Logic ground	V _{CC} - 25	V _{CC} + 0.3		
V _{LO1,2,3}	Low side output voltage	-0.3	V _{CC} + 0.3		
V _{IN}	Input voltage LIN,HIN,ITRIP, EN, RCIN	V _{SS} - 0.3	lower of (V _{SS} + 15) or (V _{CC} + 0.3)		
V _{FLT}	FAULT output voltage	V _{SS} - 0.3	V _{CC} + 0.3		
dV/dt	Allowable offset voltage slew rate	—	50	V/ns	
P _D	Package power dissipation @ T _A ≤ +25°C	(28 lead PDIP)	—	1.5	W
		(28 lead SOIC)	—	1.6	
		(44 lead PLCC)	—	2.0	
R _{thJA}	Thermal resistance, junction to ambient	(28 lead PDIP)	—	83	°C/W
		(28 lead SOIC)	—	78	
		(44 lead PLCC)	—	63	
T _J	Junction temperature	—	150	°C	
T _S	Storage temperature	-55	150		
T _L	Lead temperature (soldering, 10 seconds)	—	300		

Recommended Operating Conditions

The Input/Output logic timing diagram is shown in figure 1. For proper operation the device should be used within the recommended conditions. All voltage parameters are absolute referenced to COM. The V_S offset rating is tested with all supplies biased at 15V differential.

Symbol	Definition	Min.	Max.	Units
V _{B1,2,3}	High side floating supply voltage	V _{S1,2,3} +12	V _{S1,2,3} +20	V
V _{S1,2,3}	High side floating supply offset voltage	Note 1	600	
V _{HO1,2,3}	High side output voltage	V _{S1,2,3}	V _{B1,2,3}	
V _{LO1,2,3}	Low side output voltage	0	V _{CC}	
V _{CC}	Low side and logic fixed supply voltage	12	20	
V _{SS}	Logic ground	-5	5	
V _{FLT}	FAULT output voltage	V _{SS}	V _{CC}	
V _{RCIN}	RCIN input voltage	V _{SS}	V _{CC}	
V _{ITRIP}	ITRIP input voltage	V _{SS}	V _{SS} +5	
V _{IN}	Logic input voltage LIN, HIN	V _{SS}	V _{SS} +5	
T _A	Ambient temperature	-40	125	°C

Note 1: Logic operational for V_S of COM -5V to COM +600V. Logic state held for V_S of COM -5V to COM -V_{BS}.
 (Please refer to the Design Tip DT97-3 for more details).

Note 2: All input pins and the ITRIP pin are internally clamped with a 5.2V zener diode.

Static Electrical Characteristics

V_{BIAS} (V_{CC} , $V_{BS1,2,3}$) = 15V unless otherwise specified. The V_{IN} , V_{TH} and I_{IN} parameters are referenced to V_{SS} and are applicable to all six channels ($H_{S1,2,3}$ and $L_{S1,2,3}$). The V_O and I_O parameters are referenced to COM and $V_{S1,2,3}$ and are applicable to the respective output leads: $H_{O1,2,3}$ and $L_{O1,2,3}$.

Symbol	Definition	Min.	Typ.	Max.	Units	Test Conditions
V_{IH}	Logic "0" input voltage $\overline{LIN1,2,3}$, $\overline{HIN1,2,3}$	3.0	—	—	V	
V_{IL}	Logic "1" input voltage $\overline{LIN1,2,3}$, $\overline{HIN1,2,3}$	—	—	0.8		
$V_{EN,TH+}$	EN positive going threshold	—	—	3		
$V_{EN,TH-}$	EN negative going threshold	0.8	—	—		
$V_{IT,TH+}$	ITRIP positive going threshold	0.37	0.46	0.55		
$V_{IT,HYS}$	ITRIP input hysteresis	—	0.07	—		
$V_{RCIN,TH+}$	RCIN positive going threshold	—	8	—		
$V_{RCIN,HYS}$	RCIN input hysteresis	—	3	—		
V_{OH}	High level output voltage, $V_{BIAS} - V_O$	—	0.9	1.4		$I_O = 20 \text{ mA}$
V_{OL}	Low level output voltage, V_O	—	0.4	0.6		$I_O = 20 \text{ mA}$
V_{CCUV+} V_{BSUV+}	V_{CC} and V_{BS} supply undervoltage positive going threshold	10.6	11.1	11.6		
V_{CCUV-} V_{BSUV-}	V_{CC} and V_{BS} supply undervoltage negative going threshold	10.4	10.9	11.4		
V_{CCUVH} V_{BSUVH}	V_{CC} and V_{BS} supply undervoltage lockout hysteresis	—	0.2	—		
I_{LK}	Offset supply leakage current	—	—	50		μA
I_{QBS}	Quiescent V_{BS} supply current	—	70	120	mA	$V_{IN} = 0\text{V}$ or 5V
I_{QCC}	Quiescent V_{CC} supply current	—	3.3	—		
$V_{IN,CLAMP}$	Input clamp voltage (HIN , LIN , $ITRIP$ and EN)	4.9	5.2	5.5	V	$I_{IN} = 100\mu\text{A}$
I_{LIN+}	Input bias current ($LOUT = HI$)	—	200	300	μA	$V_{LIN} = 5\text{V}$
I_{LIN-}	Input bias current ($LOUT = LO$)	—	100	220		$V_{LIN} = 0\text{V}$
I_{HIN+}	Input bias current ($HOUT = HI$)	—	200	300		$V_{HIN} = 5\text{V}$
I_{HIN-}	Input bias current ($HOUT = LO$)	—	100	220		$V_{HIN} = 0\text{V}$
I_{ITRIP+}	"high" ITRIP input bias current	—	30	100		$V_{ITRIP} = 5\text{V}$
I_{ITRIP-}	"low" ITRIP input bias current	—	0	1		$V_{ITRIP} = 0\text{V}$
I_{EN+}	"high" ENABLE input bias current	—	30	100		$V_{ENABLE} = 5\text{V}$
I_{EN-}	"low" ENABLE input bias current	—	0	1		$V_{ENABLE} = 0\text{V}$
I_{RCIN}	RCIN input bias current	—	0	1		$V_{RCIN} = 0\text{V}$ or 15V
I_{O+}	Output high short circuit pulsed current	120	200	—		mA
I_{O-}	Output low short circuit pulsed current	250	350	—	$V_O = 15\text{V}$, $PW \leq 10 \mu\text{s}$	
$R_{ON,RCIN}$	RCIN low on resistance	—	50	100	Ω	
$R_{ON,FLT}$	FAULT low on resistance	—	50	100		

Dynamic Electrical Characteristics

$V_{CC} = V_{BS} = V_{BIAS} = 15V$, $V_{S1,2,3} = V_{SS} = COM$, $T_A = 25^\circ C$ and $C_L = 1000$ pF unless otherwise specified.

Symbol	Definition	Min.	Typ.	Max.	Units	Test Conditions
t_{on}	Turn-on propagation delay	370	525	680	nS	$V_{IN} = 0$ & 5V
t_{off}	Turn-off propagation delay	310	500	690		
t_r	Turn-on rise time	—	125	190		
t_f	Turn-off fall time	—	50	75		$V_{IN}, V_{EN} = 0V$ or 5V
t_{EN}	ENABLE low to output shutdown propagation delay	300	450	600		
t_{ITRIP}	ITRIP to output shutdown propagation delay	500	750	1000		
t_{bl}	ITRIP blanking time	100	150	—	nS	$V_{IN} = 0V$ or 5V $V_{ITRIP} = 5V$
t_{FLT}	ITRIP to FAULT propagation delay	400	600	800		$V_{IN} = 0V$ or 5V $V_{ITRIP} = 5V$
t_{FILIN}	Input filter time (HIN, LIN) (EN)	— 100	310 200	—		$V_{IN} = 0$ & 5V
t_{FLTCLR}	FAULT clear time RCIN: R=2meg, C=1nF	1.3	1.65	2	mS	$V_{IN} = 0V$ or 5V $V_{ITRIP} = 0V$
DT	Deadtime	220	290	360	nS	$V_{IN} = 0$ & 5V
MT	Matching delay ON and OFF	—	40	75		External dead time >400nsec
MDT	Matching delay, max (t_{on}, t_{off}) - min (t_{on}, t_{off}), (t_{on}, t_{off} are applicable to all 3 channels)	—	25	70		
PM	Output pulse width matching, PWin -PWout (fig.2)	—	40	75		

NOTE: For high side PWM, HIN pulse width must be $\geq 1\mu sec$

VCC	VBS	ITRIP	ENABLE	FAULT	LO1,2,3	HO1,2,3
<UVCC	X	X	X	0 (note 1)	0	0
15V	<UVBS	0V	5V	high imp	LIN1,2,3	0
15V	15V	0V	5V	high imp	LIN1,2,3	HIN1,2,3
15V	15V	> V_{ITRIP}	5V	0 (note 2)	0	0
15V	15V	0V	0V	high imp	0	0

Note: A shoot-through prevention logic prevents LO1,2,3 and HO1,2,3 for each channel from turning on simultaneously.

Note 1: UVCC is not latched, when $V_{CC} > UVCC$, FAULT returns to high impedance.

Note 2: When $ITRIP < V_{ITRIP}$, FAULT returns to high-impedance after RCIN pin becomes greater than 8V (@ $V_{CC} = 15V$)

Functional Block Diagram

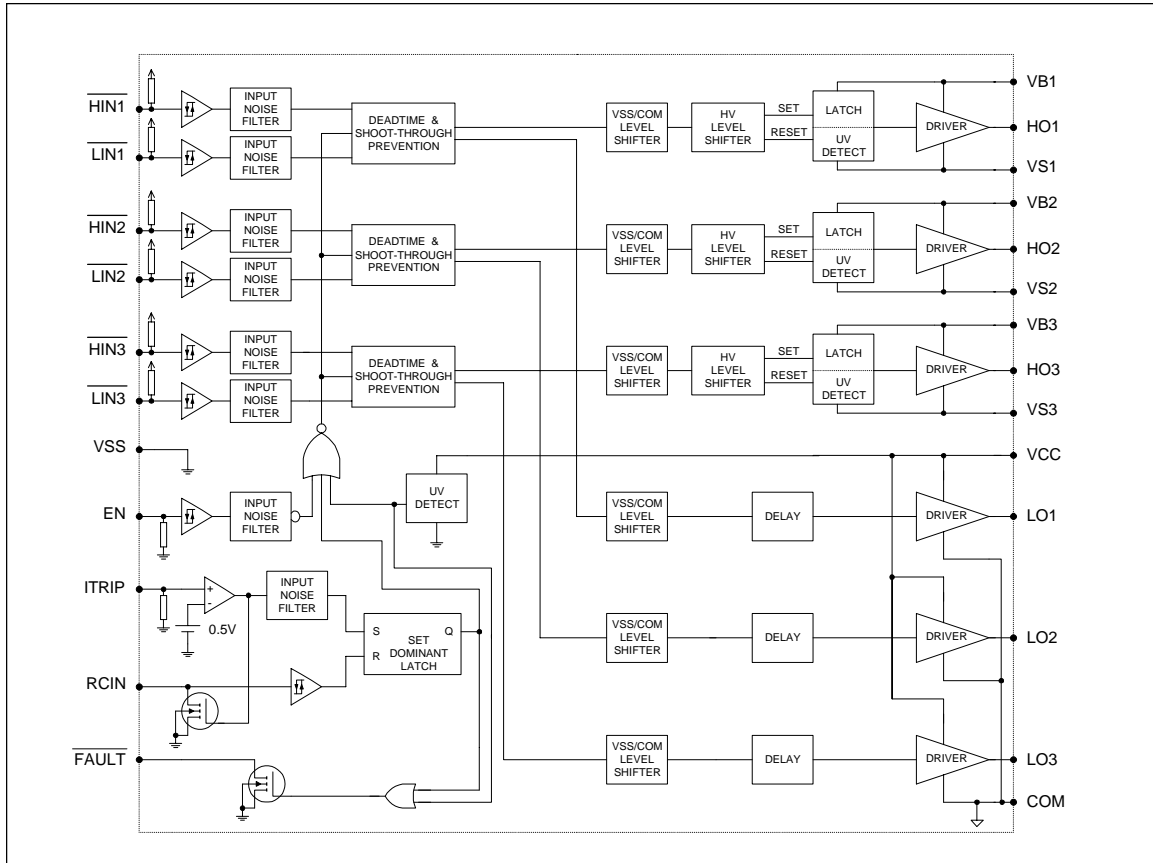

Lead Definitions

Symbol	Description
V _{CC}	Low side and logic fixed supply
V _{SS}	Logic Ground
HIN _{1,2,3}	Logic inputs for high side gate driver outputs (HO _{1,2,3}), out of phase
LIN _{1,2,3}	Logic inputs for low side gate driver outputs (LO _{1,2,3}), out of phase
FAULT	Indicates over-current (ITRIP) or low-side undervoltage lockout has occurred. Negative logic, open-drain output
EN	Logic input to enable I/O functionality. Positive logic, i.e. I/O logic functions when ENABLE is high. No effect on FAULT and not latched
ITRIP	Analog input for overcurrent shutdown. When active, ITRIP shuts down outputs and activates FAULT and RCIN low. When ITRIP becomes inactive, FAULT stays active low for an externally set time T _{FLTCLR} , then automatically becomes inactive (open-drain high impedance).
RCIN	External RC network input used to define FAULT CLEAR delay, T _{FLTCLR} , approximately equal to R*C. When RCIN>8V, the FAULT pin goes back into open-drain high-impedance
COM	Low side gate driver return
V _{B1,2,3}	High side floating supply
HO _{1,2,3}	High side gate driver outputs
V _{S1,2,3}	High voltage floating supply returns
LO _{1,2,3}	Low side gate driver output

Note: All input pins and the ITRIP pin are internally clamped with a 5.2V zener diode.

Lead Assignments

<p>28 Lead PDIP</p>	<p>44 Lead PLCC w/o 12 leads</p>	<p>28 lead SOIC (wide body)</p>
IR21363	IR21363(J)	IR21363(S)

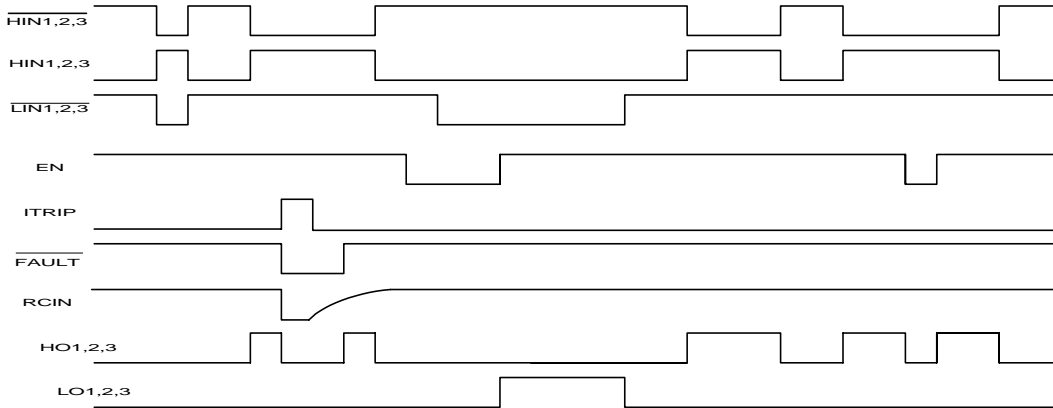

Figure 1. Input/Output Timing Diagram

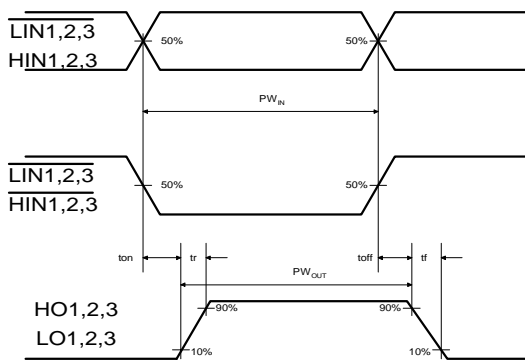

Figure 2. Switching Time Waveforms

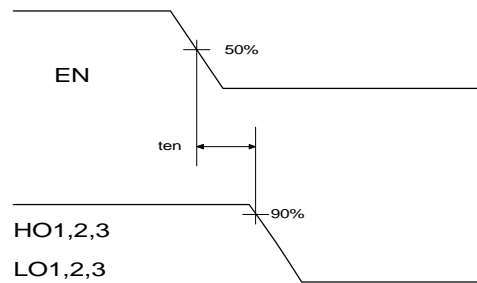

Figure 3. Output Enable Timing Waveform

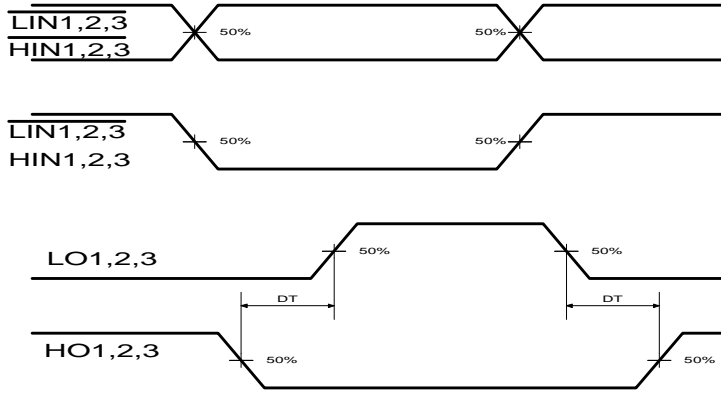

Figure 4. Internal Deadtime Timing Waveforms

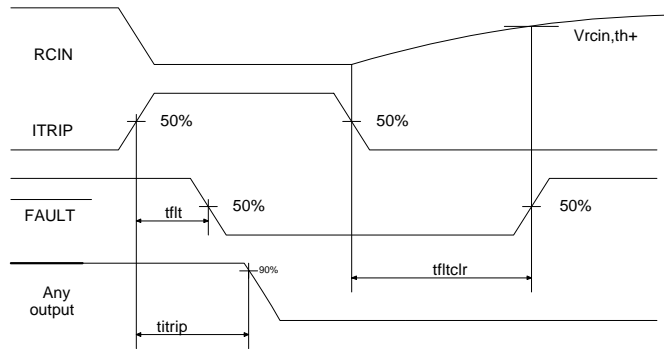

Figure 5. ITRIP/RCIN Timing Waveforms

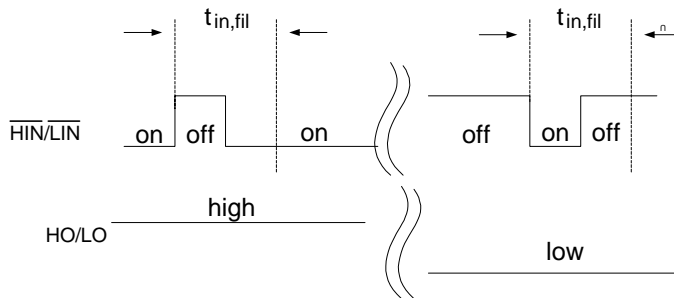

Figure 5.5 Input Filter Function

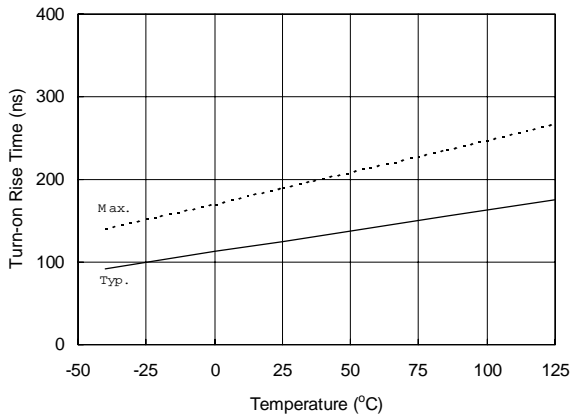

Figure 6A. Turn-on Rise Time vs. Temperature

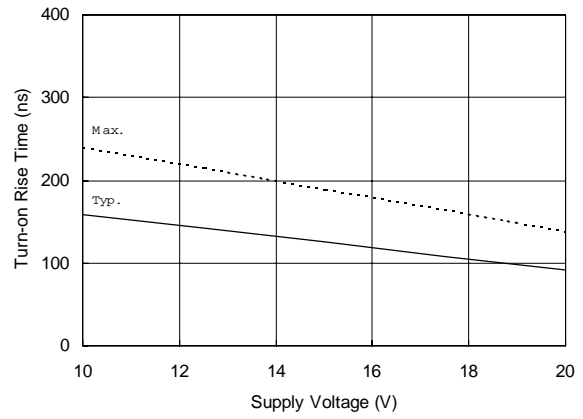

Figure 6B. Turn-on Rise Time vs. Supply Voltage

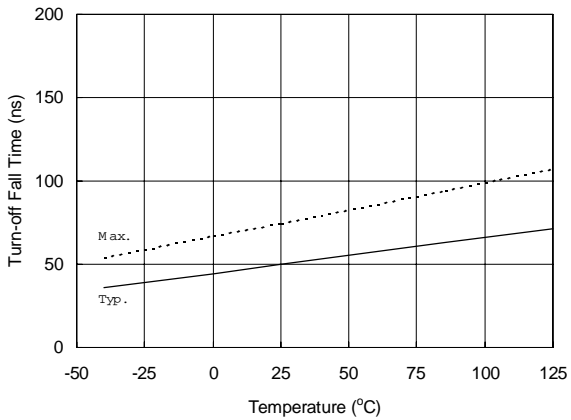

Figure 7A. Turn-off Fall Time vs. Temperature

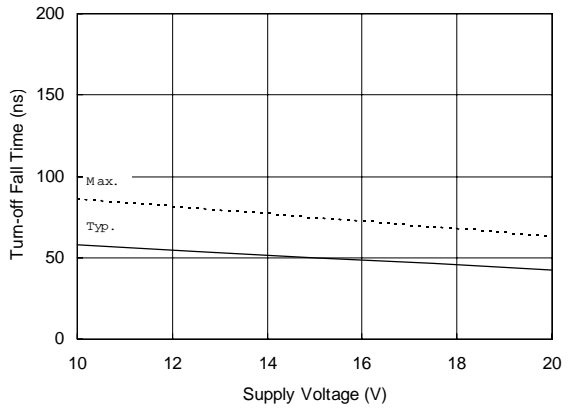

Figure 7B. Turn-off Fall Time vs. Supply Voltage

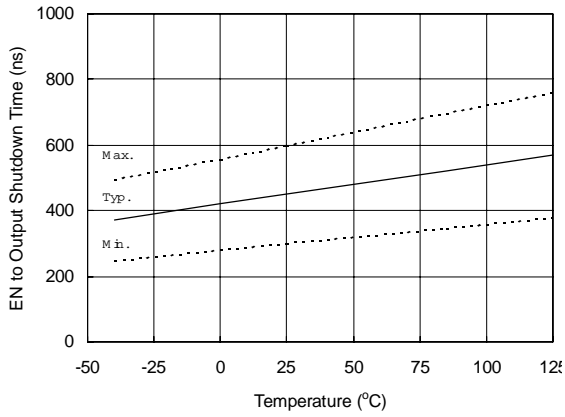

Figure 8A. EN to Output Shutdown Time vs. Temperature

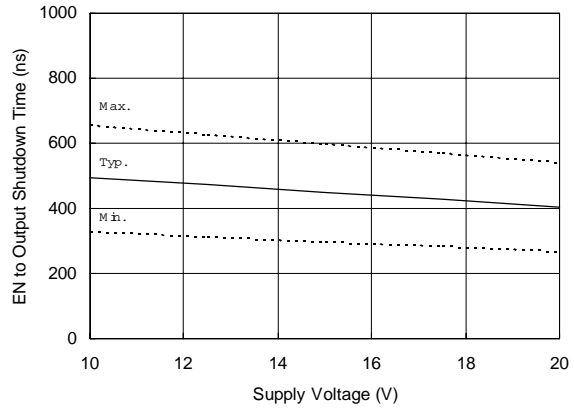

Figure 8B. EN to Output Shutdown Time vs. Supply Voltage

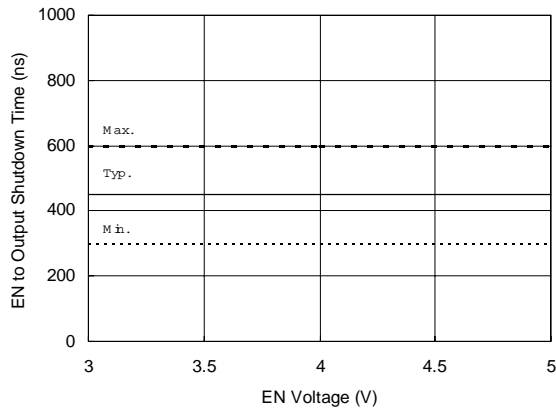

Figure 8C. EN to Output Shutdown Time vs. EN Voltage

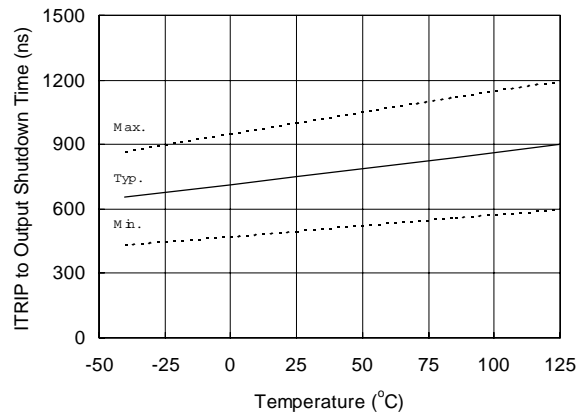

Figure 9A. ITRIP to Output Shutdown Time vs. Temperature

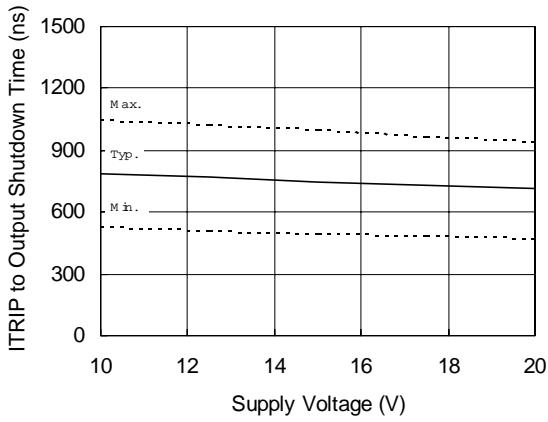

Figure 9B. ITRIP to Output Shutdown Time vs. Supply Voltage

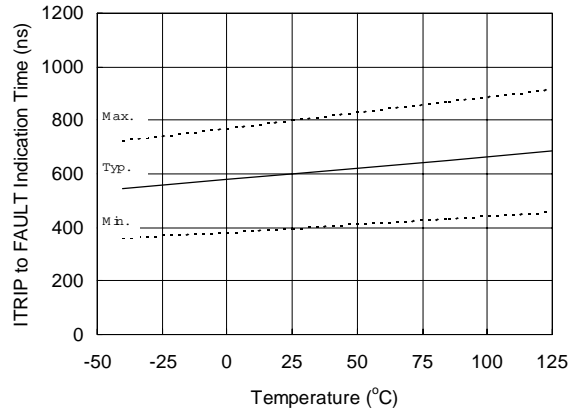

Figure 10A. ITRIP to FAULT Indication Time vs. Temperature

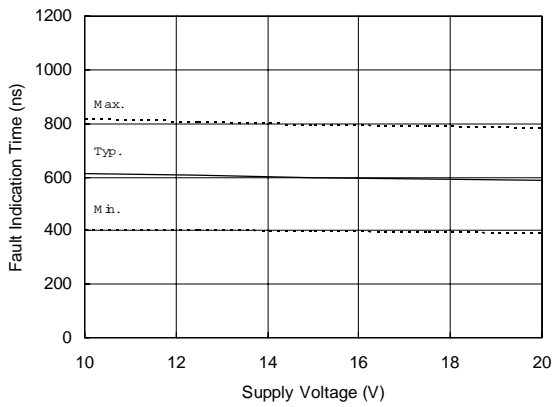

Figure 10B. ITRIP to FAULT Indication Time vs. Supply Voltage

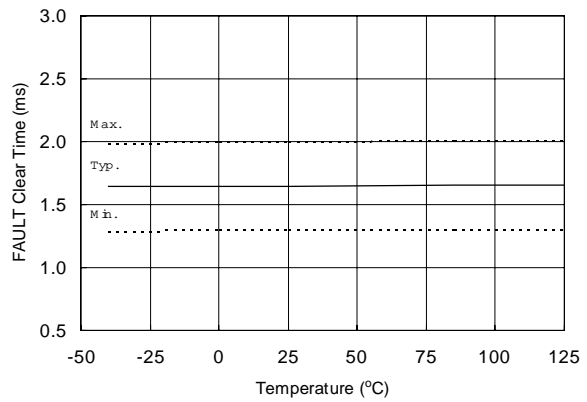

Figure 11A. FAULT Clear Time vs. Temperature

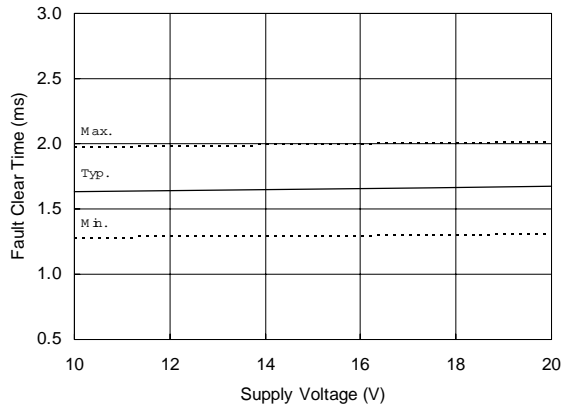

Figure 11B. FAULT Clear Time vs. Supply Voltage

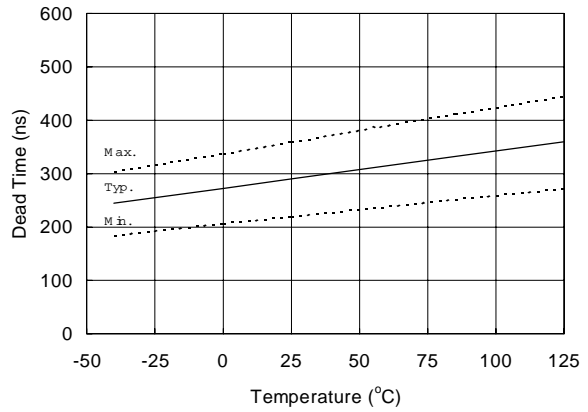

Figure 12A. Dead Time vs. Temperature

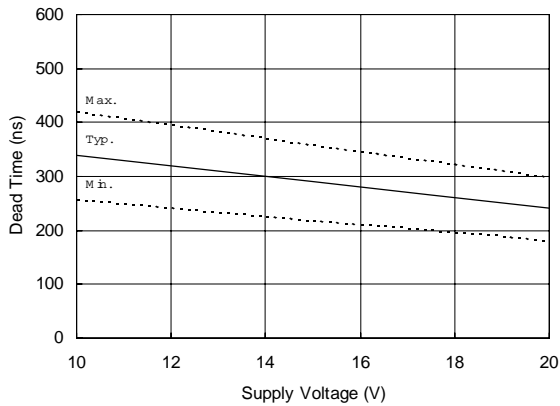

Figure 12B. Dead Time vs. Supply Voltage

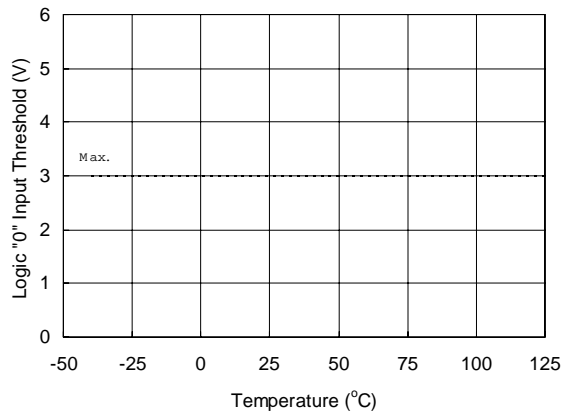

Figure 13A. Logic "0" Input Threshold vs. Temperature

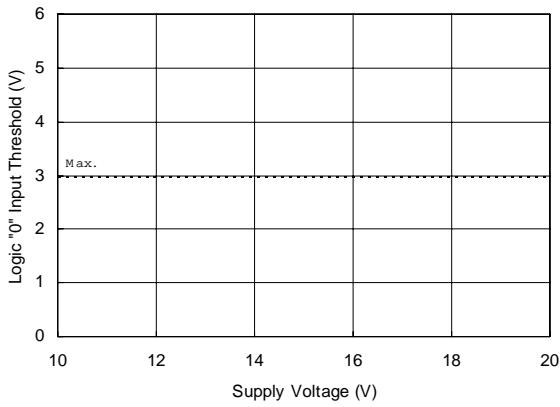

Figure 13B. Logic "0" Input Threshold vs. Supply Voltage

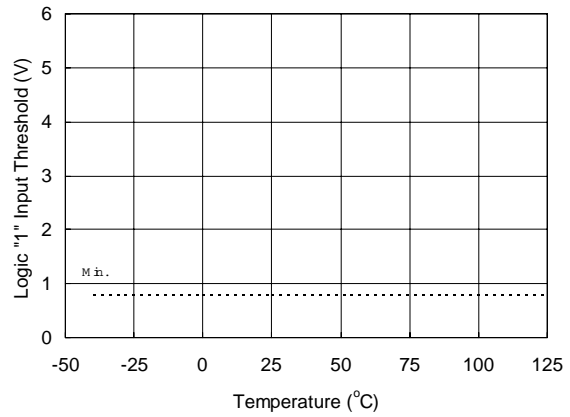

Figure 14A. Logic "1" Input Threshold vs. Temperature

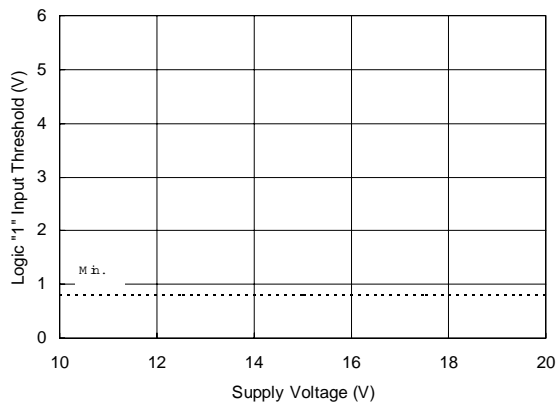

Figure 14B. Logic "1" Input Threshold vs. Supply Voltage

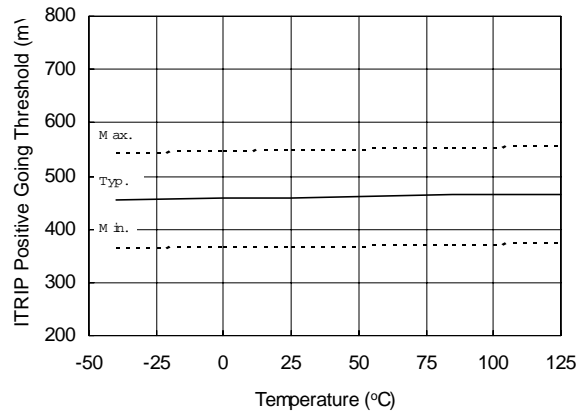

Figure 15A. ITRIP Positive Going Threshold vs. Temperature

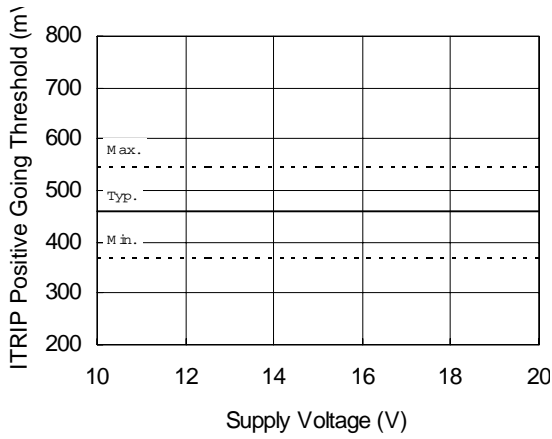

Figure 15B. ITRIP Positive Going Threshold vs. Supply Voltage

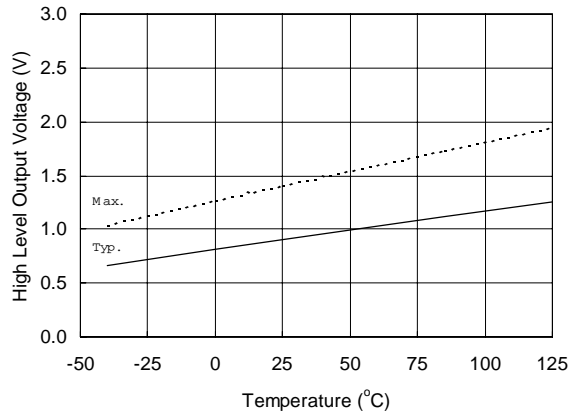

Figure 16A. High Level Output vs. Temperature

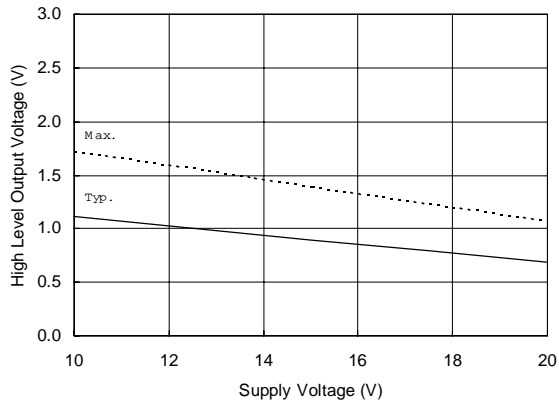

Figure 16B. High Level Output vs. Supply Voltage

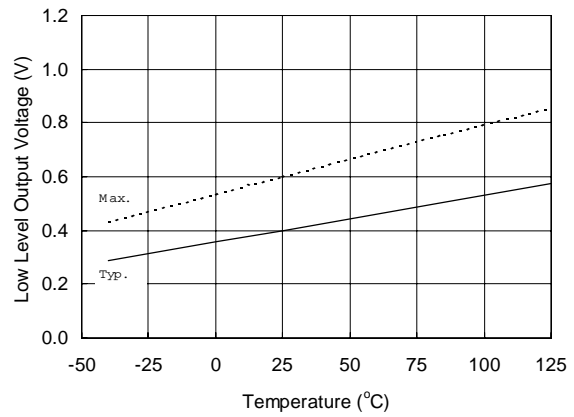

Figure 17A. Low Level Output vs. Temperature

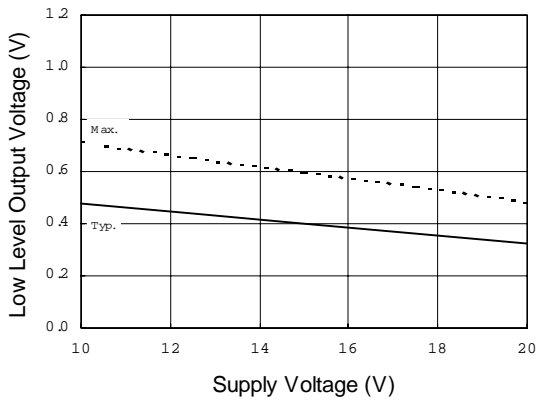

Figure 17B. Low Level Output vs. Supply Voltage

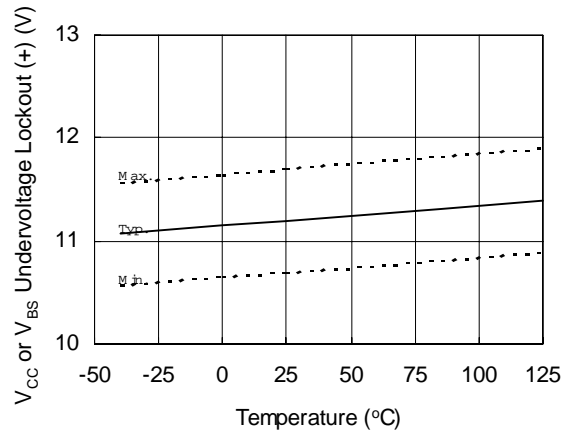

Figure 18. V_{CC} or V_{BS} Undervoltage Lockout (+) vs. Temperature

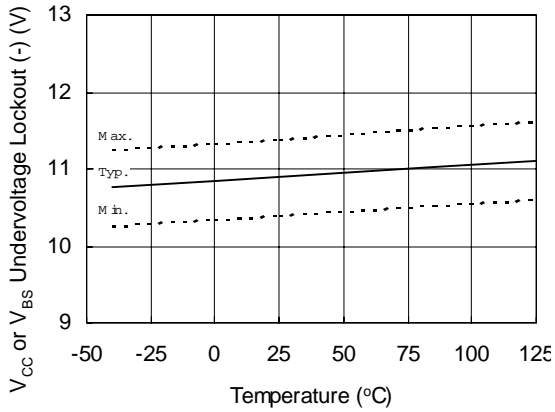

Figure 19. V_{CC} or V_{BS} Undervoltage Lockout (-) vs. Temperature

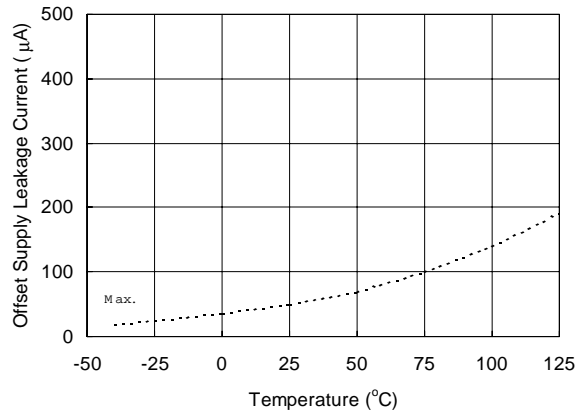

Figure 20A. Offset Supply Leakage Current vs. Temperature

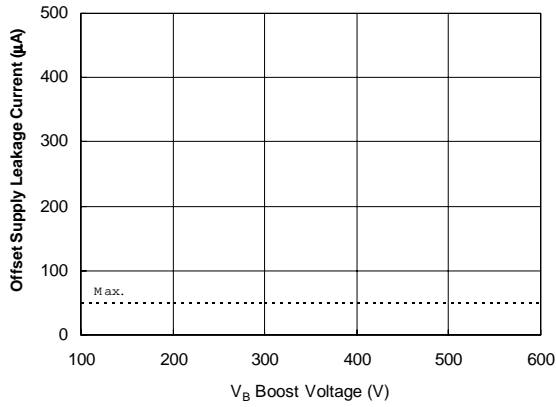

Figure 20B. Offset Supply Leakage Current vs. V_B Boost Voltage

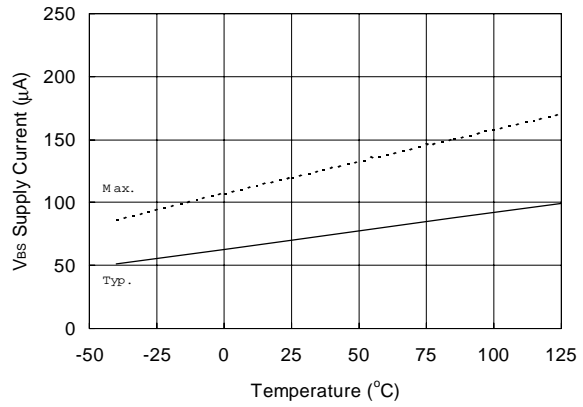

Figure 21A. V_B Supply Current vs. Temperature

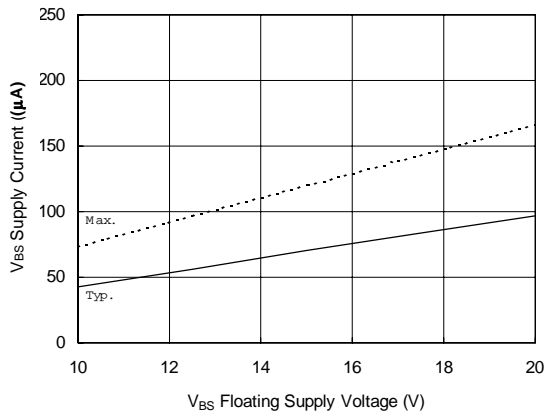

Figure 21B. V_{BS} Supply Current vs. V_{BS} Floating Supply Voltage

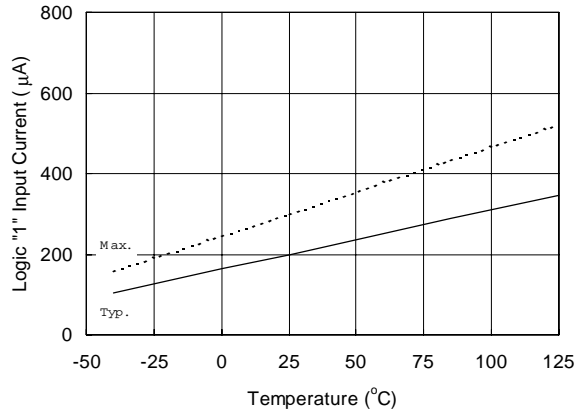

Figure 22A. Input Current vs. Temperature

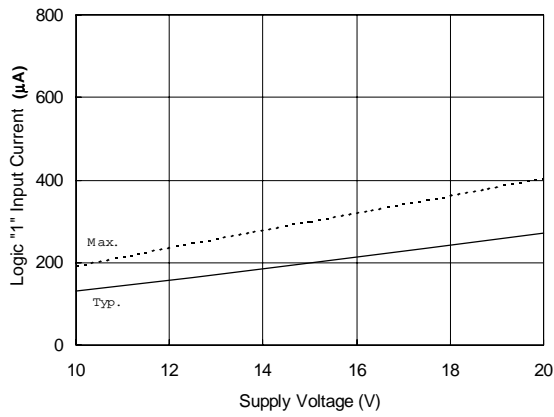

Figure 22B. Logic "1" Input Current vs. Supply Voltage

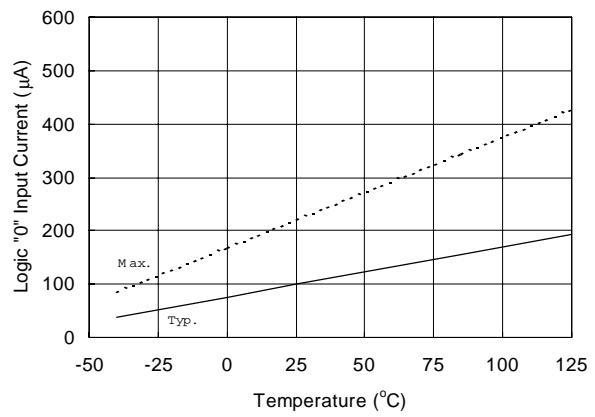

Figure 23A. Logic "0" Input Current vs. Temperature

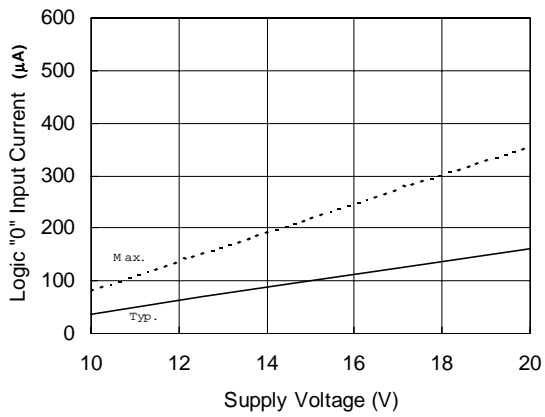

Figure 23B. Logic "0" Input Current vs. Supply Voltage

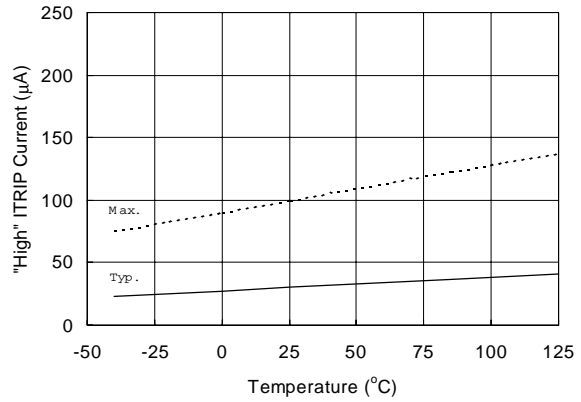

Figure 24A. High ITRIP Current vs. Temperature

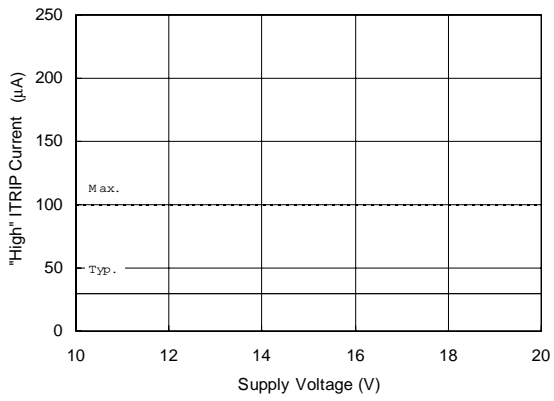

Figure 24B. "High" ITRIP Current vs. Supply Voltage

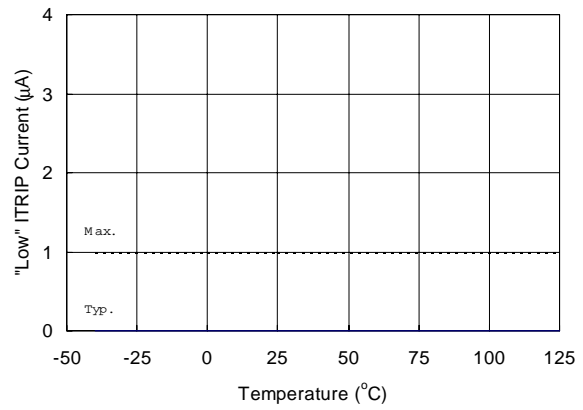

Figure 25A. "Low" ITRIP Current vs. Temperature

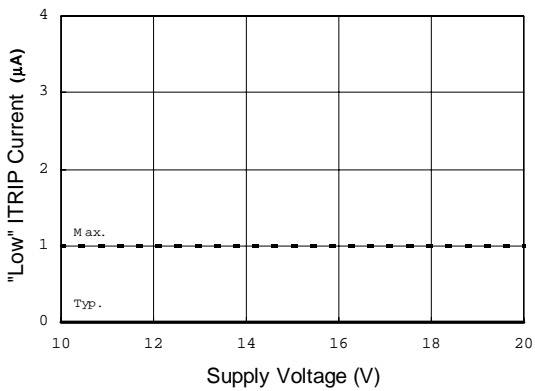

Figure 25B. ITRIP Current vs. Supply Voltage

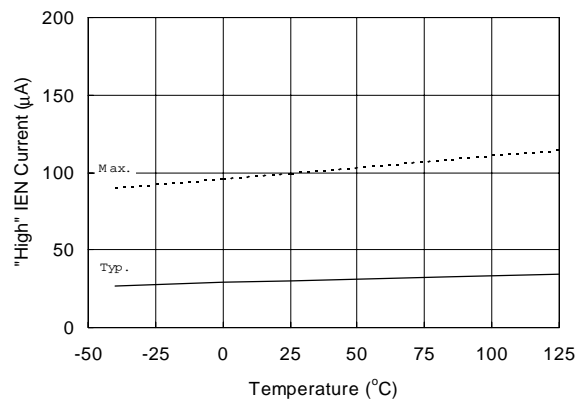

Figure 26A. "High" IEN Current vs. Temperature

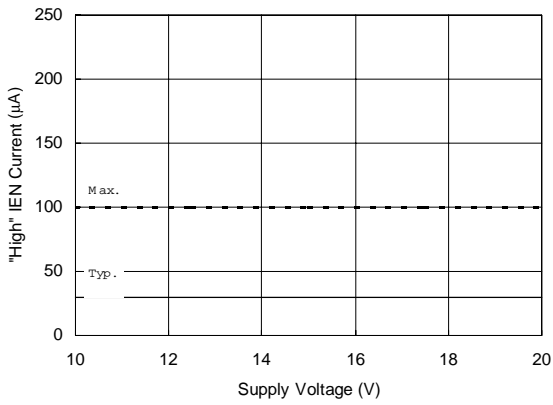

Figure 26B. "High" IEN Current vs. Supply Voltage

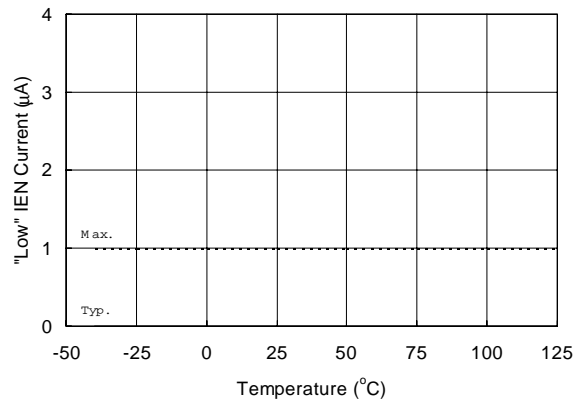

Figure 27A. "Low" IEN Current vs. Temperature

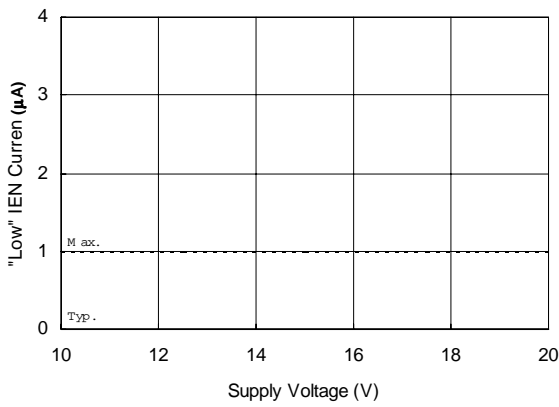

Figure 27B. IEN Current vs. Supply Voltage

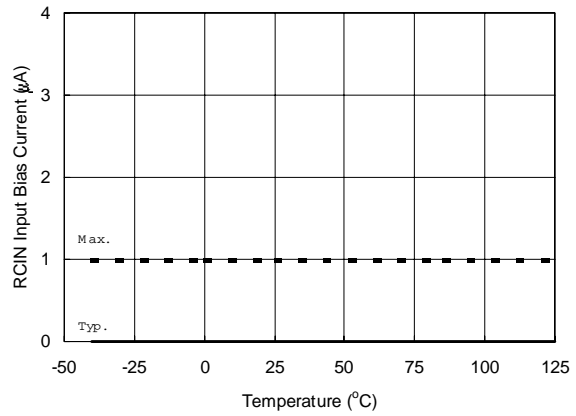

Figure 28A. RCIN Input Bias Current vs. Temperature

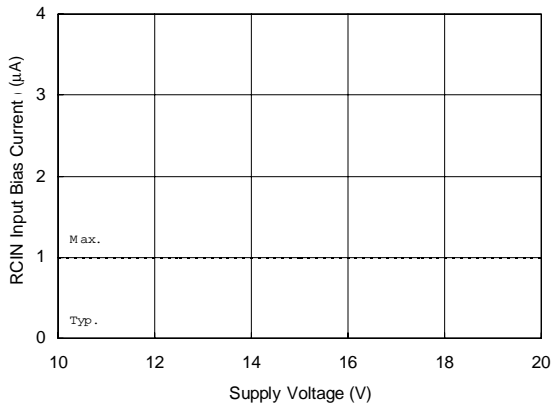

Figure 28B. RCIN Input Bias Current vs. Supply Voltage

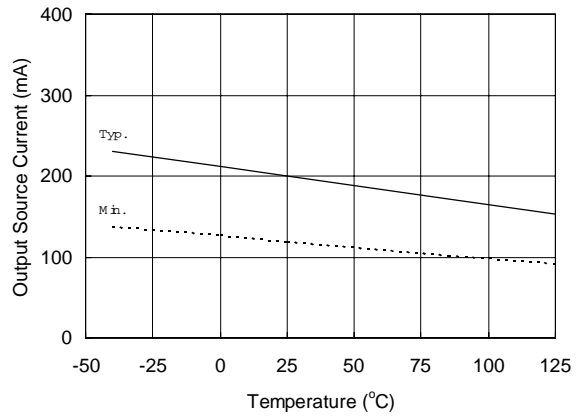

Figure 29A. Output Source Current vs. Temperature

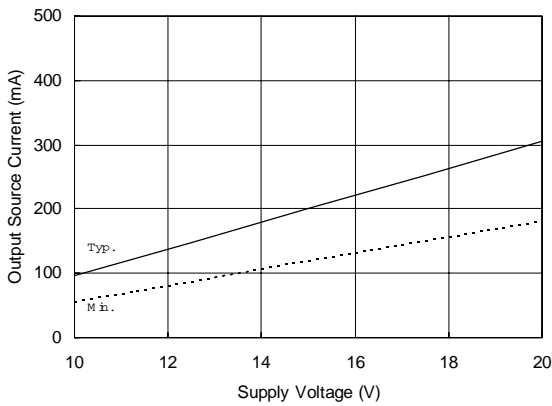

Figure 29B. Output Source Current vs. Supply Voltage

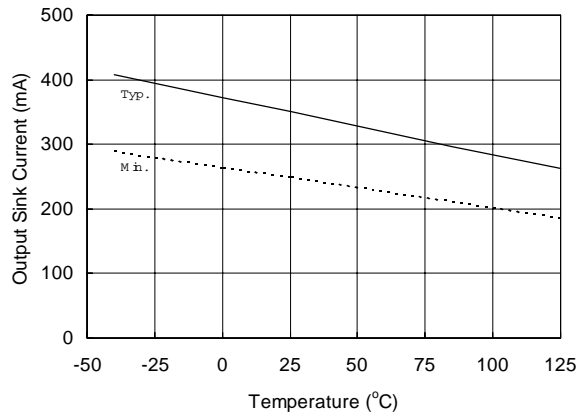

Figure 30A. Output Sink Current vs. Temperature

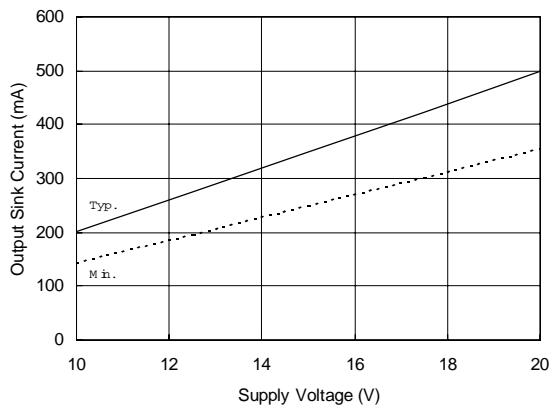

Figure 30B. Output Sink Current vs. Supply Voltage

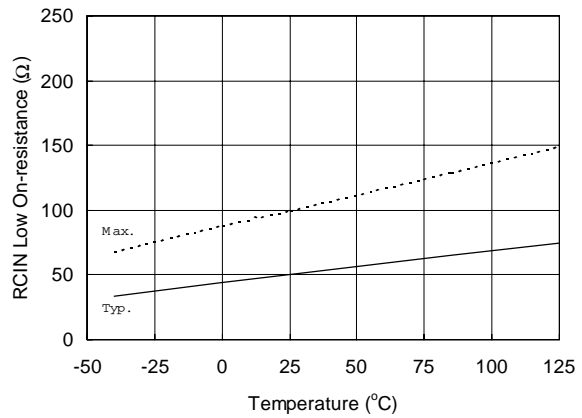

Figure 31A. RCIN Low On-resistance vs. Temperature

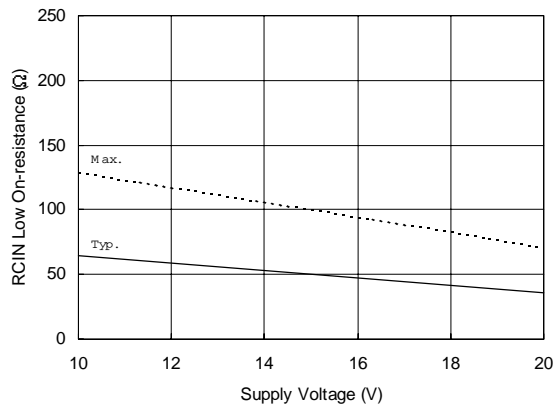

Figure 31B. RCIN Low On-resistance vs. Supply Voltage

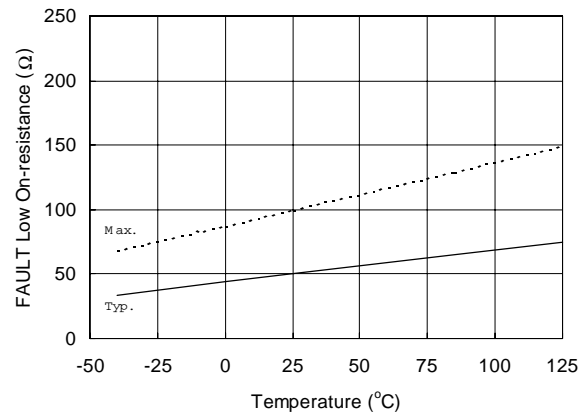

Figure 32A. FAULT Low On-resistance vs. Temperature

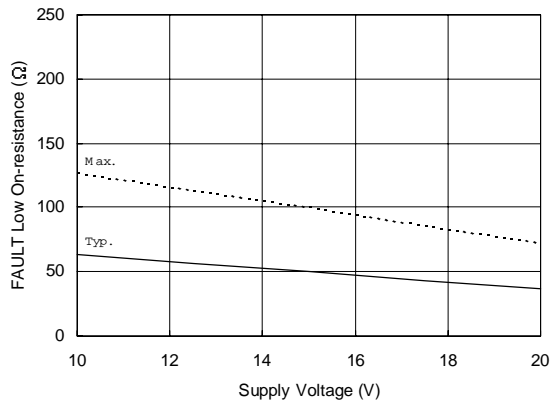

Figure 32B. FAULT Low On-resistance vs. Supply Voltage

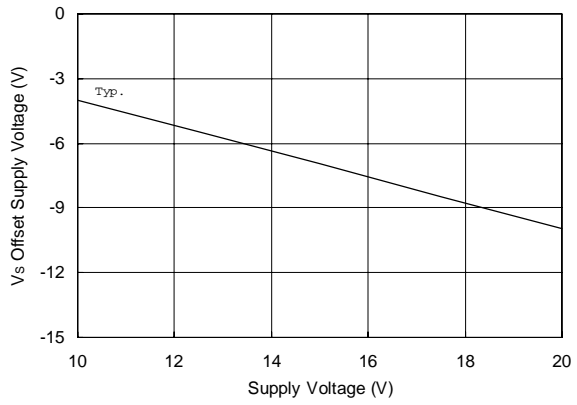

Figure 33. Maximum V_S Negative Offset vs. V_{BS} Supply Voltage

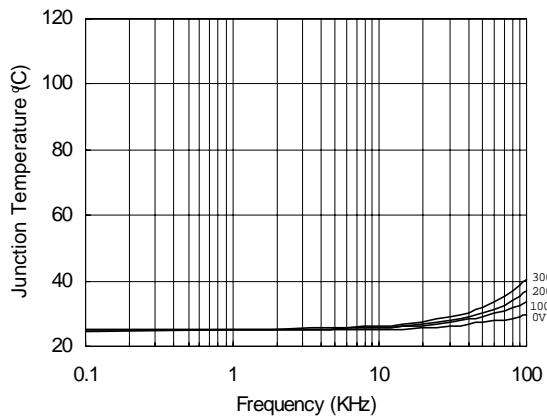

Figure 34. IR21363 vs. Frequency (IRG4BC20W), Rgate=33Ω, Vcc=15V

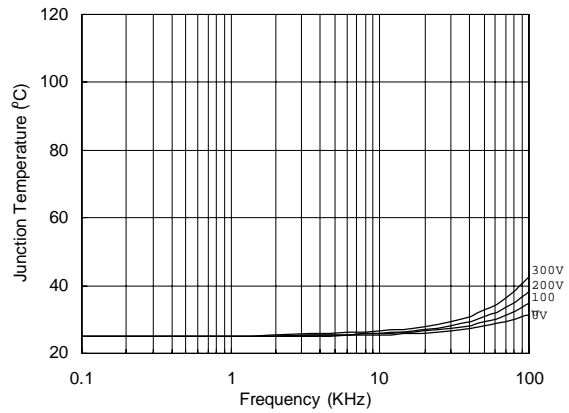

Figure 35. IR21363 vs. Frequency (IRG4BC30W), Rgate=15Ω, Vcc=15V

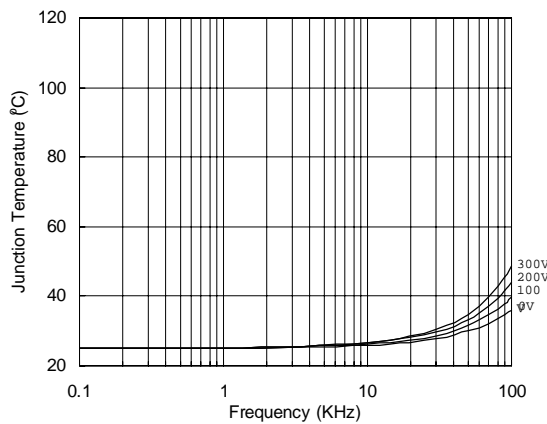

Figure 36. IR21363 vs. Frequency (IRG4BC40W), Rgate=10Ω, Vcc=15V

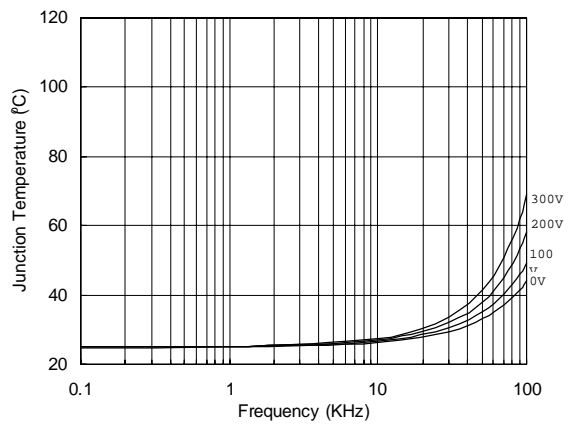

Figure 37. IR21363 vs. Frequency (IRG4PC50W), Rgate=5Ω, Vcc=15V

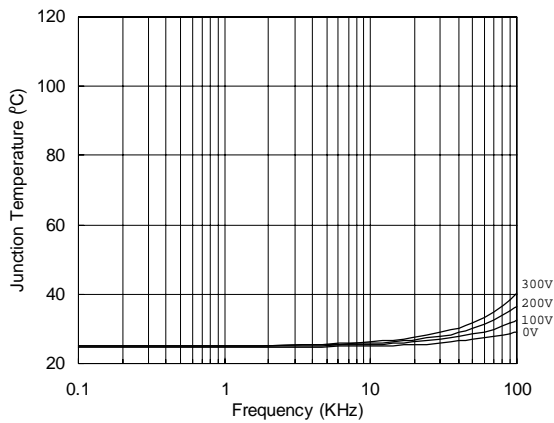

Figure 38. IR21363 (J) vs. Frequency (IRG4BC20W), Rgate=33Ω, Vcc=15V

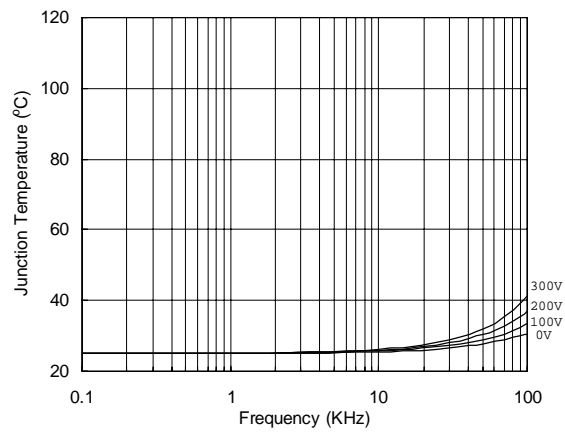

Figure 39. IR21363 (J) vs. Frequency (IRG4BC30W), Rgate=15Ω, Vcc=15V

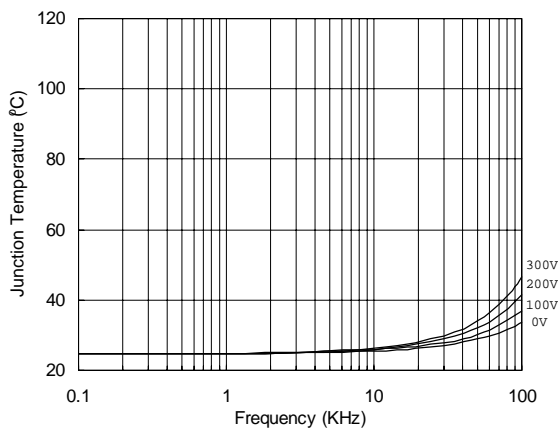

Figure 40. IR21363 (J) vs. Frequency (IRG4BC40W), Rgate=10Ω, Vcc=15V

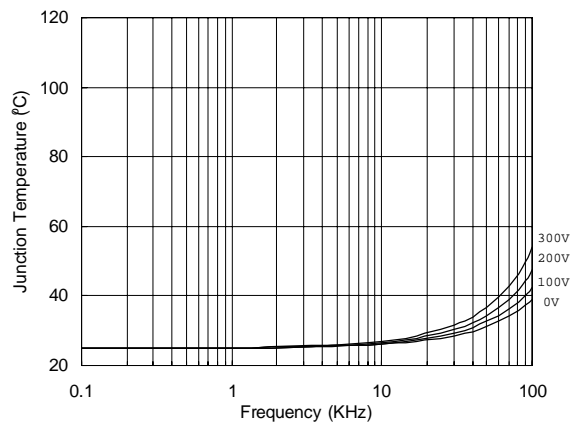

Figure 41. IR21363 (J) vs. Frequency (IRG4PC50W), Rgate=5Ω, Vcc=15V

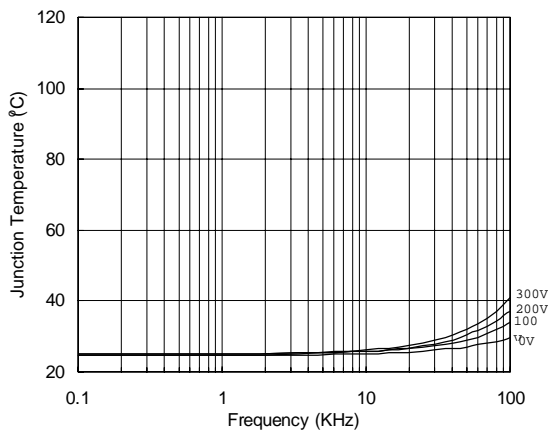

Figure 42. IR21363 (S) vs. vs. Frequency (IRG4BC20W), Rgate=33Ω, Vcc=15V

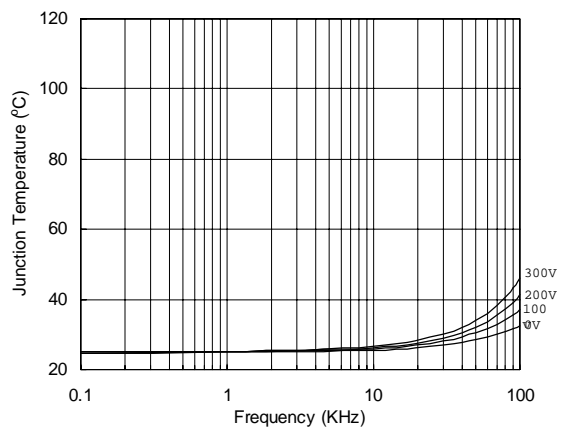

Figure 43. IR21363 (S) vs. vs. Frequency (IRG4BC30W), Rgate=15Ω, Vcc=15V

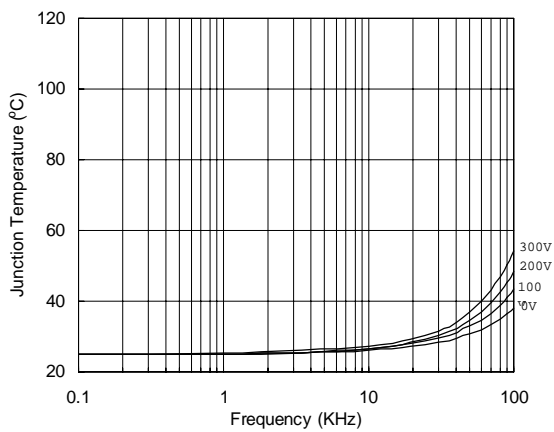

Figure 44. IR21363 (S) vs. vs. Frequency (IRG4BC40W), Rgate=10Ω, Vcc=15V

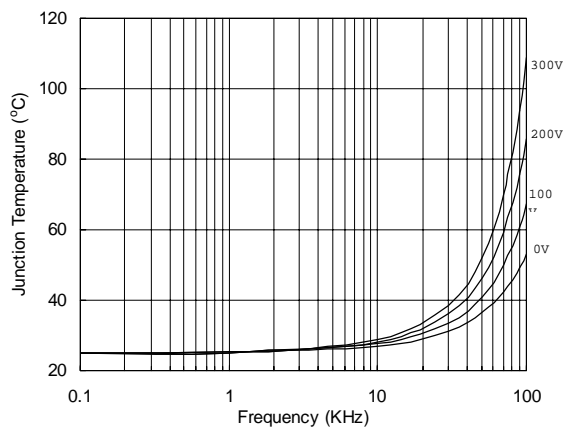
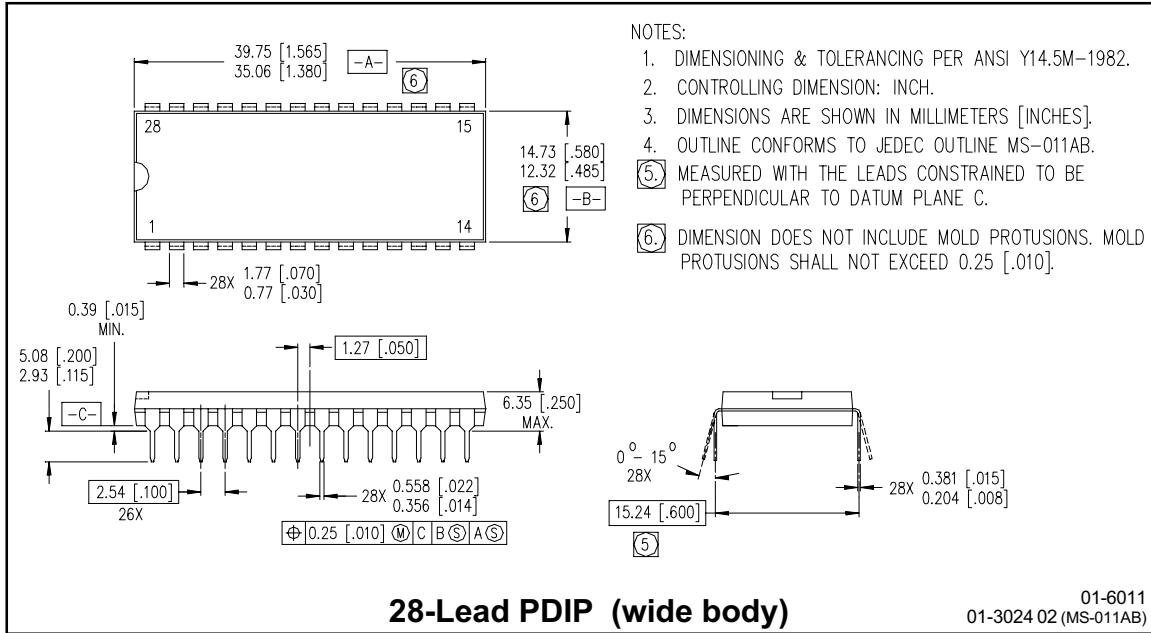
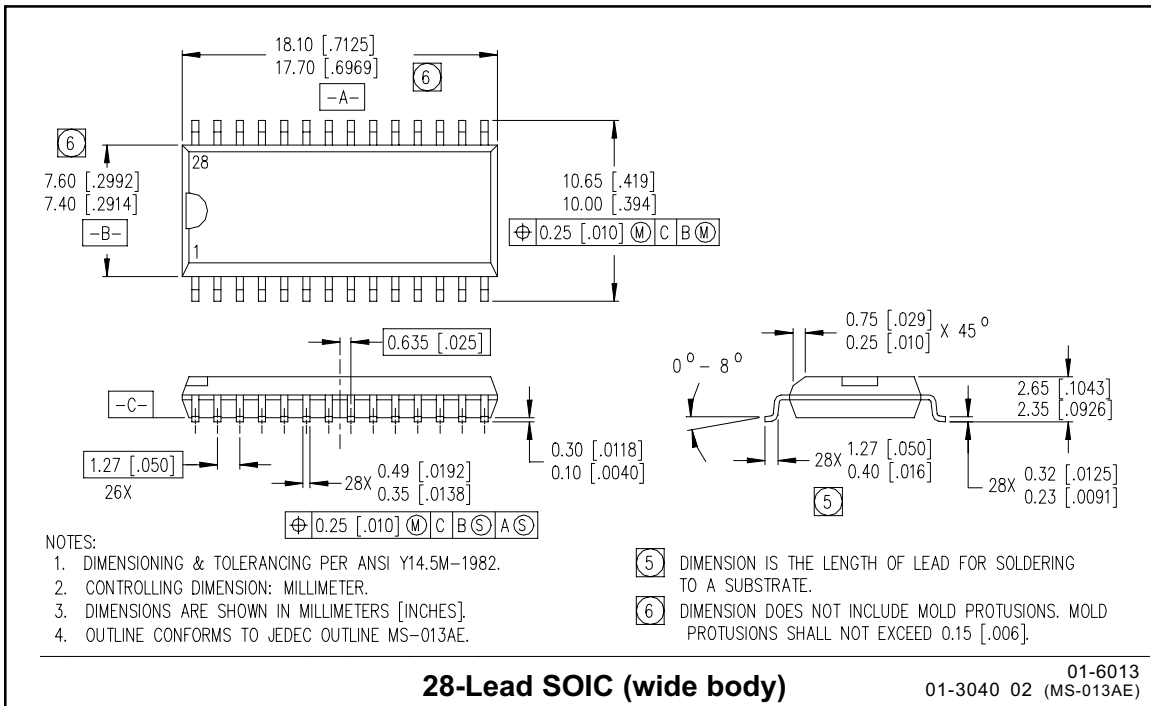

Figure 45. IR21363 (S) vs. vs. Frequency (IRG4PC50W), Rgate=5Ω, Vcc=15V

Case outlines



- NOTES:
1. DIMENSIONING & TOLERANCING PER ANSI Y14.5M-1982.
 2. CONTROLLING DIMENSION: INCH.
 3. DIMENSIONS ARE SHOWN IN MILLIMETERS [INCHES].
 4. OUTLINE CONFORMS TO JEDEC OUTLINE MS-011AB.
 - ⑤ MEASURED WITH THE LEADS CONSTRAINED TO BE PERPENDICULAR TO DATUM PLANE C.
 - ⑥ DIMENSION DOES NOT INCLUDE MOLD PROTUSIONS. MOLD PROTUSIONS SHALL NOT EXCEED 0.25 [.010].



- NOTES:
1. DIMENSIONING & TOLERANCING PER ANSI Y14.5M-1982.
 2. CONTROLLING DIMENSION: MILLIMETER.
 3. DIMENSIONS ARE SHOWN IN MILLIMETERS [INCHES].
 4. OUTLINE CONFORMS TO JEDEC OUTLINE MS-013AE.
 - ⑤ DIMENSION IS THE LENGTH OF LEAD FOR SOLDERING TO A SUBSTRATE.
 - ⑥ DIMENSION DOES NOT INCLUDE MOLD PROTUSIONS. MOLD PROTUSIONS SHALL NOT EXCEED 0.15 [.006].

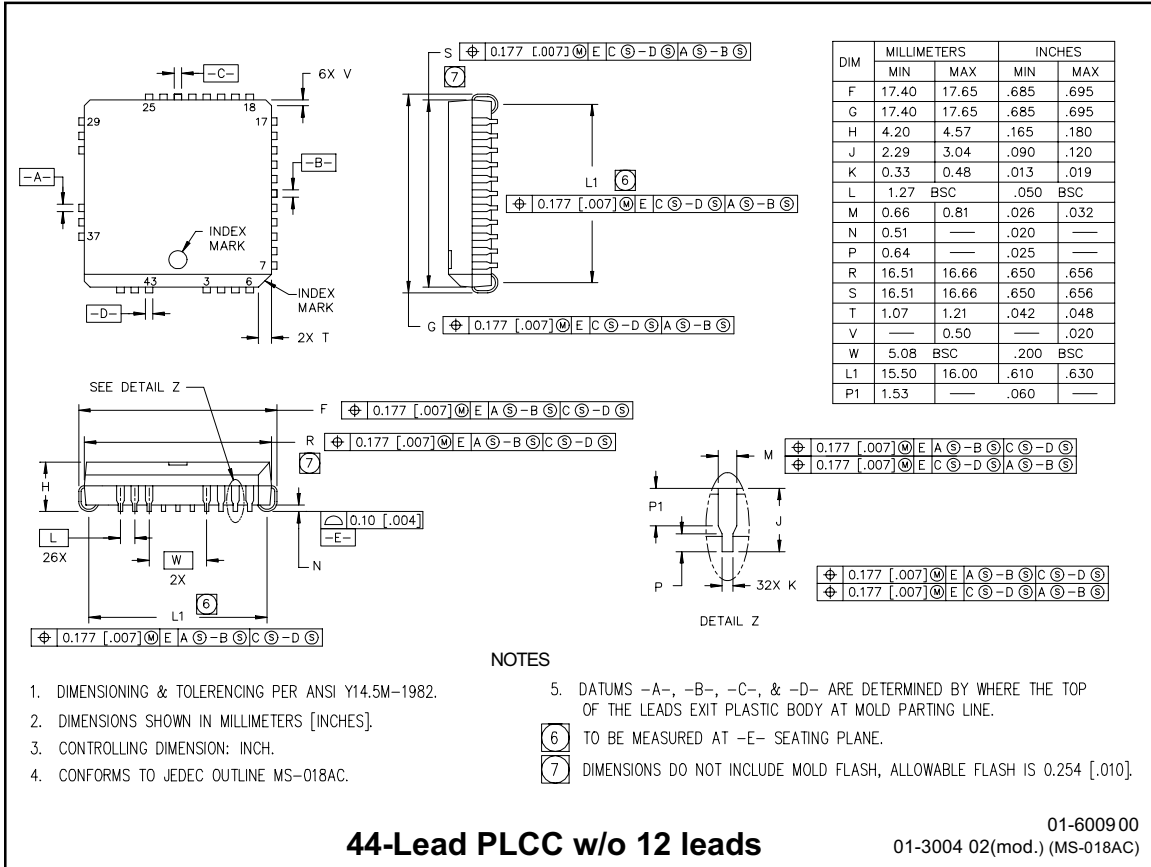

Mouser Electronics

Authorized Distributor

Click to View Pricing, Inventory, Delivery & Lifecycle Information:

[Infineon:](#)

[IR21363JTRPBF](#) [IR21363STRPBF](#) [IR21363JPBF](#) [IR21363SPBF](#)

Компания «Океан Электроники» предлагает заключение долгосрочных отношений при поставках импортных электронных компонентов на взаимовыгодных условиях!

Наши преимущества:

- Поставка оригинальных импортных электронных компонентов напрямую с производств Америки, Европы и Азии, а так же с крупнейших складов мира;
- Широкая линейка поставок активных и пассивных импортных электронных компонентов (более 30 млн. наименований);
- Поставка сложных, дефицитных, либо снятых с производства позиций;
- Оперативные сроки поставки под заказ (от 5 рабочих дней);
- Экспресс доставка в любую точку России;
- Помощь Конструкторского Отдела и консультации квалифицированных инженеров;
- Техническая поддержка проекта, помощь в подборе аналогов, поставка прототипов;
- Поставка электронных компонентов под контролем ВП;
- Система менеджмента качества сертифицирована по Международному стандарту ISO 9001;
- При необходимости вся продукция военного и аэрокосмического назначения проходит испытания и сертификацию в лаборатории (по согласованию с заказчиком);
- Поставка специализированных компонентов военного и аэрокосмического уровня качества (Xilinx, Altera, Analog Devices, Intersil, Interpoint, Microsemi, Actel, Aeroflex, Peregrine, VPT, Syfer, Eurofarad, Texas Instruments, MS Kennedy, Miteq, Cobham, E2V, MA-COM, Hittite, Mini-Circuits, General Dynamics и др.);

Компания «Океан Электроники» является официальным дистрибьютором и эксклюзивным представителем в России одного из крупнейших производителей разъемов военного и аэрокосмического назначения «JONHON», а так же официальным дистрибьютором и эксклюзивным представителем в России производителя высокотехнологичных и надежных решений для передачи СВЧ сигналов «FORSTAR».



JONHON

«JONHON» (основан в 1970 г.)

Разъемы специального, военного и аэрокосмического назначения:

(Применяются в военной, авиационной, аэрокосмической, морской, железнодорожной, горно- и нефтедобывающей отраслях промышленности)

«FORSTAR» (основан в 1998 г.)

ВЧ соединители, коаксиальные кабели,
кабельные сборки и микроволновые компоненты:

(Применяются в телекоммуникациях гражданского и специального назначения, в средствах связи, РЛС, а так же военной, авиационной и аэрокосмической отраслях промышленности).



Телефон: 8 (812) 309-75-97 (многоканальный)

Факс: 8 (812) 320-03-32

Электронная почта: ocean@oceanchips.ru

Web: <http://oceanchips.ru/>

Адрес: 198099, г. Санкт-Петербург, ул. Калинина, д. 2, корп. 4, лит. А