

EVALUATION KITS  
AVAILABLE

# MAXIM

## High-Side Power and Current Monitors

MAX4210/MAX4211

### General Description

The MAX4210/MAX4211 low-cost, low-power, high-side power/current monitors provide an analog output voltage proportional to the power consumed by a load by multiplying load current and source voltage. The MAX4210/MAX4211 measure load current by using a high-side current-sense amplifier, making them especially useful in battery-powered systems by not interfering with the ground path of the load.

The MAX4210 is a small, simple 6-pin power monitor intended for limited board space applications. The MAX4210A/B/C integrate an internal 25:1 resistor-divider network to reduce component count. The MAX4210D/E/F use an external resistor-divider network for greater design flexibility.

The MAX4211 is a full-featured current and power monitor. The device combines a high-side current-sense amplifier, 1.21V bandgap reference, and two comparators with open-drain outputs to make detector circuits for overpower, overcurrent, and/or overvoltage conditions. The open-drain outputs can be connected to potentials as high as 28V, suitable for driving high-side switches for circuit-breaker applications.

Both the MAX4210/MAX4211 feature three different current-sense amplifier gain options: 16.67V/V, 25.00V/V, and 40.96V/V. The MAX4210 is available in 3mm x 3mm, 6-pin TDFN and 8-pin  $\mu$ MAX<sup>®</sup> packages and the MAX4211 is available in 4mm x 4mm, 16-pin thin QFN and 16-pin TSSOP packages. Both parts are specified for the -40°C to +85°C extended operating temperature range.

### Applications

- Overpower Circuit Breakers
- Smart Battery Packs/Chargers
- Smart Peripheral Control
- Short-Circuit Protection
- Power-Supply Displays
- Measurement Instrumentation
- Baseband Analog Multipliers
- VGA Circuits
- Power-Level Detectors

$\mu$ MAX is a registered trademark of Maxim Integrated Products, Inc.

Pin Configurations and Selector Guide appear at end of data sheet.

### Features

- ◆ Real-Time Current and Power Monitoring
- ◆  $\pm 1.5\%$  (max) Current-Sense Accuracy
- ◆  $\pm 1.5\%$  (max) Power-Sense Accuracy
- ◆ Two Uncommitted Comparators (MAX4211)
- ◆ 1.21V Reference Output (MAX4211)
- ◆ Three Current/Power Gain Options
- ◆ 100mV/150mV Current-Sense Full-Scale Voltage
- ◆ +4V to +28V Input Source Voltage Range
- ◆ +2.7V to +5.5V Power-Supply Voltage Range
- ◆ Low Supply Current: 380 $\mu$ A (MAX4210)
- ◆ 220kHz Bandwidth
- ◆ Small 6-Pin TDFN and 8-Pin  $\mu$ MAX Packages (MAX4210)

### Ordering Information

| PART          | TEMP RANGE     | PIN-PACKAGE                 | TOP MARK |
|---------------|----------------|-----------------------------|----------|
| MAX4210AETT-T | -40°C to +85°C | 6 TDFN-6-EP*<br>(3mm x 3mm) | AHF      |
| MAX4210AEUUA  | -40°C to +85°C | 8 $\mu$ MAX                 | —        |

\*EP = Exposed paddle.

Ordering Information continued at end of data sheet.

### Functional Diagrams



MAXIM

Maxim Integrated Products 1

For pricing, delivery, and ordering information, please contact Maxim/Dallas Direct! at 1-888-629-4642, or visit Maxim's website at [www.maxim-ic.com](http://www.maxim-ic.com).

# High-Side Power and Current Monitors

## ABSOLUTE MAXIMUM RATINGS

V<sub>CC</sub>, I<sub>N</sub>, C<sub>IN1</sub>, C<sub>IN2</sub> to GND .....-0.3V to +6V  
 R<sub>S+</sub>, R<sub>S-</sub>, I<sub>NHIBIT</sub>, L<sub>E</sub>, C<sub>OUT1</sub>, C<sub>OUT2</sub> to GND .....-0.3V to +30V  
 I<sub>OUT</sub>, P<sub>OUT</sub>, R<sub>E<sub>F</sub></sub> to GND .....-0.3V to (V<sub>CC</sub> + 0.3V)  
 Differential Input Voltage (V<sub>RS+</sub> - V<sub>RS-</sub>) .....±5V  
 Maximum Current into Any Pin .....±10mA  
 Output Short-Circuit Duration to V<sub>CC</sub> or GND ..... 10s  
 Continuous Power Dissipation (T<sub>A</sub> = +70°C)  
 6-Pin TDFN (derate 24.4mW/°C above +70°C) .....1951mW

8-Pin  $\mu$ MAX (derate 4.5mW/°C above +70°C) .....362mW  
 16-Pin TSSOP (derate 9.4mW/°C above +70°C) .....754mW  
 16-Pin Thin QFN (derate 25mW/°C above +70°C) .....2000mW  
 Operating Temperature Range .....-40°C to +85°C  
 Junction Temperature .....+150°C  
 Storage Temperature Range .....-65°C to +150°C  
 Lead Temperature (soldering, 10s) .....+300°C

Stresses beyond those listed under "Absolute Maximum Ratings" may cause permanent damage to the device. These are stress ratings only, and functional operation of the device at these or any other conditions beyond those indicated in the operational sections of the specifications is not implied. Exposure to absolute maximum rating conditions for extended periods may affect device reliability.

## ELECTRICAL CHARACTERISTICS

(V<sub>CC</sub> = 5.0V, V<sub>RS+</sub> = 25V, V<sub>SENSE</sub> = 5mV, V<sub>IN</sub> = 1.0V, V<sub>LE</sub> = 0V, R<sub>IOUT</sub> = R<sub>POUT</sub> = 1M $\Omega$ , V<sub>CIN1+</sub> = V<sub>CIN2+</sub> = V<sub>REF</sub>, V<sub>CIN1-</sub> = V<sub>CIN2-</sub> = GND, V<sub>INHIBIT</sub> = 0V, R<sub>COUT1</sub> = R<sub>COUT2</sub> = 5k $\Omega$  connected to V<sub>CC</sub>, T<sub>A</sub> = -40°C to +85°C, unless otherwise noted. Typical values are at T<sub>A</sub> = +25°C, unless otherwise noted.) (Note 1)

| PARAMETER   | SYMBOL                              | CONDITIONS   |   | MIN  | TYP  | MAX                    | UNITS   |      |
|---|-------------------------------------|--|---|------|------|------------------------|---------|------|
| Operating Voltage Range (Note 2)                            | V <sub>CC</sub>                     |  |   | 2.7  |      | 5.5                    | V       |      |
| Common-Mode Input Range (Note 3)                            | V <sub>CMR</sub>                    | Measured at R <sub>S+</sub>                        |   | 4    |      | 28                     | V       |      |
| Supply Current  | I <sub>CC</sub>                     | T <sub>A</sub> = +25°C,<br>V <sub>CC</sub> = +5.5V | MAX4210                                       |      | 380  | 570                    | $\mu$ A |      |
|   |                                     |  | MAX4211                                       |      | 670  | 960                    |         |      |
|   |                                     | V <sub>CC</sub> = +5.5V                            | MAX4210                                       |      |      | 670                    |         |      |
|   |                                     |  | MAX4211                                       |      |      |                        |         | 1100 |
| Input Bias Current  | I <sub>RS+</sub>                    | V <sub>SENSE</sub> = 0mV                           | MAX421_A/B/C                                  |      | 14   | 25                     | $\mu$ A |      |
|   | I <sub>RS-</sub>                    |  | MAX421_D/E/F                                  |      | 3    | 8                      |         |      |
| IN Input Bias Current                                       | I <sub>IN</sub>                     | MAX421_D/E/F                                       |   |      | -0.1 | -1                     | $\mu$ A |      |
| Leakage Current   | I <sub>RS+</sub> , I <sub>RS-</sub> | V <sub>CC</sub> = 0V                               |   |      | 0.1  | 1                      | $\mu$ A |      |
| V <sub>SENSE</sub> Full-Scale Voltage (Note 4)              | V <sub>SENSE_FS</sub>               | MAX421_A/B/D/E                                     |   | 150  |      |                        | mV      |      |
|   |                                     | MAX421_C/F   |   | 100  |      |                        |         |      |
| IN Full-Scale Voltage (Note 4)                              | V <sub>IN_FS</sub>                  | MAX421_D/E/F, V <sub>SENSE</sub> = 10mV to 100mV   |   | 1    |      |                        | V       |      |
| IN Input Voltage Range (Note 5)                             | V <sub>IN</sub>                     | MAX421_D/E/F, V <sub>SENSE</sub> = 10mV to 100mV   |   | 0.16 |      | 1.10                   | V       |      |
| V <sub>RS+</sub> Full-Scale Voltage (Note 4)                |                                     | MAX421_A/B/C, V <sub>SENSE</sub> = 10mV to 100mV   |   | 25   |      |                        | V       |      |
| V <sub>RS+</sub> Input Voltage Range (Note 5)               | V <sub>RS+</sub>                    | MAX421_A/B/C, V <sub>SENSE</sub> = 10mV to 100mV   |   | 4    |      | 28                     | V       |      |
| Minimum I <sub>OUT</sub> /P <sub>OUT</sub> Voltage          | V <sub>OUT_MIN</sub>                | V <sub>SENSE</sub> = 0V, V <sub>RS+</sub> = 25V    | Current into I <sub>OUT</sub> = 10 $\mu$ A    |      | 1.5  |                        | mV      |      |
|   |                                     |  | Current into I <sub>OUT</sub> = 100 $\mu$ A   |      | 2.5  | 80                     |         |      |
|   |                                     |  | Current into P <sub>OUT</sub> = 10 $\mu$ A    |      | 1.5  |                        |         |      |
|   |                                     |  | Current into P <sub>OUT</sub> = 100 $\mu$ A   |      | 2.5  | 80                     |         |      |
| Maximum I <sub>OUT</sub> /P <sub>OUT</sub> Voltage (Note 6) | V <sub>OUT_MAX</sub>                | V <sub>SENSE</sub> = 300mV, V <sub>RS+</sub> = 25V | Current out of I <sub>OUT</sub> = 500 $\mu$ A |      |      | V <sub>CC</sub> - 0.25 | V       |      |
|   |                                     |  | Current out of P <sub>OUT</sub> = 500 $\mu$ A |      |      | V <sub>CC</sub> - 0.25 |         |      |

# High-Side Power and Current Monitors

MAX4210/MAX4211

## ELECTRICAL CHARACTERISTICS (continued)

( $V_{CC} = 5.0V$ ,  $V_{RS+} = 25V$ ,  $V_{SENSE} = 5mV$ ,  $V_{IN} = 1.0V$ ,  $V_{LE} = 0V$ ,  $R_{IOUT} = R_{POUT} = 1M\Omega$ ,  $V_{CIN1+} = V_{CIN2+} = V_{REF}$ ,  $V_{CIN1-} = V_{CIN2-} = GND$ ,  $V_{INHIBIT} = 0V$ ,  $R_{COUT1} = R_{COUT2} = 5k\Omega$  connected to  $V_{CC}$ ,  $T_A = -40^{\circ}C$  to  $+85^{\circ}C$ , unless otherwise noted. Typical values are at  $T_A = +25^{\circ}C$ , unless otherwise noted.) (Note 1)

| PARAMETER  | SYMBOL                                | CONDITIONS  | MIN  | TYP   | MAX | UNITS    |
|--|---------------------------------------|---|--|-------|-----|----------|
| Current-Sense Amplifier Gain                             | $V_{IOUT}/V_{SENSE}$                  | MAX4211A/D  |  | 16.67 |     | V/V      |
|  |                                       | MAX4211B/E  |  | 25.00 |     |          |
|  |                                       | MAX4211C/F  |  | 40.96 |     |          |
| Power-Sense Amplifier Gain                               | $V_{POUT}/(V_{SENSE} \times V_{RS+})$ | MAX421_A  |  | 0.667 |     | 1/V      |
|  |                                       | MAX421_B  |  | 1.00  |     |          |
|  |                                       | MAX421_C  |  | 1.64  |     |          |
|  | $V_{POUT}/(V_{SENSE} \times V_{IN})$  | MAX421_D  |  | 16.67 |     |          |
|  |                                       | MAX421_E  |  | 25.00 |     |          |
|  |                                       | MAX421_F  |  | 40.96 |     |          |
| IOUT Common-Mode Rejection                               | CMRI                                  | MAX4211, $V_{RS+} = 4V$ to $28V$                        | 60   | 80    |     | dB       |
| POUT Common-Mode Rejection                               | CMRP                                  | MAX421_D/E/F, $V_{RS+} = 4V$ to $28V$                   | 60   | 80    |     | dB       |
| IOUT Power-Supply Rejection                              | PSRI                                  | $V_{CC} = 2.7V$ to $5.5V$                               | 52   | 80    |     | dB       |
| POUT Power-Supply Rejection                              | PSRP                                  | $V_{CC} = 2.7V$ to $5.5V$                               | 52   | 70    |     | dB       |
| Output Resistance for POUT, IOUT, REF                    | $R_{OUT}$                             |   |  | 0.5   |     | $\Omega$ |
| IOUT -3dB Bandwidth                                      | $BW_{IOUT/SENSE}$                     | $V_{SENSE} = 100mV$ , $V_{SENSE}$ AC source             |  | 220   |     | kHz      |
| POUT -3dB Bandwidth                                      | $BW_{POUT/SENSE}$                     | $V_{SENSE} = 100mV$ , $V_{SENSE}$ AC source             |  | 220   |     | kHz      |
|  | $BW_{POUT/VIN}$                       | $V_{SENSE} = 100mV$ , $V_{IN}$ AC source, MAX421_D/E/F  |  | 500   |     |          |
|  | $BW_{POUT/RS+}$                       | $V_{SENSE} = 100mV$ , $V_{RS+}$ AC source, MAX421_A/B/C |  | 250   |     |          |
| Capacitive-Load Stability (POUT, IOUT, REF)              | $C_{LOAD}$                            | No sustained oscillations                               |  | 450   |     | pF       |
| Current Output (IOUT) Settling Time to 1% of Final Value |                                       | MAX4211   | $V_{SENSE} = 10mV$ to $100mV$                  | 15    |     | $\mu s$  |
|  |                                       |   | $V_{SENSE} = 100mV$ to $10mV$                  | 15    |     |          |
| Power Output (POUT) Settling Time to 1% of Final Value   | MAX421_A/B/C                          |   | $V_{SENSE} = 10mV$ to $100mV$                  | 10    |     | $\mu s$  |
|  |                                       |   | $V_{SENSE} = 100mV$ to $10mV$                  | 10    |     |          |
|  |                                       |   | $V_{RS+} = 4V$ to $25V$ , $V_{SENSE} = 100mV$  | 15    |     |          |
|  |                                       |   | $V_{RS+} = 25V$ to $4V$ , $V_{SENSE} = 100mV$  | 15    |     |          |
|  | MAX421_D/E/F                          |   | $V_{SENSE} = 10mV$ to $100mV$                  | 10    |     |          |
|  |                                       |   | $V_{SENSE} = 100mV$ to $10mV$                  | 10    |     |          |
|  |                                       |   | $V_{IN} = 160mV$ to $1V$ , $V_{SENSE} = 100mV$ | 10    |     |          |
|  |                                       |   | $V_{IN} = 1V$ to $160mV$ , $V_{SENSE} = 100mV$ | 10    |     |          |

# High-Side Power and Current Monitors

## ELECTRICAL CHARACTERISTICS (continued)

( $V_{CC} = 5.0V$ ,  $V_{RS+} = 25V$ ,  $V_{SENSE} = 5mV$ ,  $V_{IN} = 1.0V$ ,  $V_{LE} = 0V$ ,  $R_{IOUT} = R_{POUT} = 1M\Omega$ ,  $V_{CIN1+} = V_{CIN2+} = V_{REF}$ ,  $V_{CIN1-} = V_{CIN2-} = GND$ ,  $V_{INHIBIT} = 0V$ ,  $R_{COUT1} = R_{COUT2} = 5k\Omega$  connected to  $V_{CC}$ ,  $T_A = -40^{\circ}C$  to  $+85^{\circ}C$ , unless otherwise noted. Typical values are at  $T_A = +25^{\circ}C$ , unless otherwise noted.) (Note 1)

| PARAMETER   | SYMBOL     | CONDITIONS   | MIN                  | TYP             | MAX                  | UNITS   |
|---|------------|--|----------------------|-----------------|----------------------|---------|
| Power-Up Time to 1% of Current Output Final Value |            | $V_{SENSE} = 100mV$ , $C_{LOAD} = 10pF$ , MAX4211                                      |                      | 100             |                      | $\mu s$ |
| Power-Up Time to 1% of Power Output Final Value   |            | $V_{SENSE} = 100mV$ , $C_{LOAD} = 10pF$  |                      | 100             |                      | $\mu s$ |
| Saturation Recovery Time for Current Out (Note 7) |            | $C_{LOAD} = 10pF$ , $V_{SENSE} = -100mV$ to $+100mV$                                   |                      | 35              |                      | $\mu s$ |
|   |            | $C_{LOAD} = 10pF$ , $V_{SENSE} = 1.5V$ to $100mV$                                      |                      | 35              |                      |         |
| Saturation Recovery Time for Power Out (Note 7)   |            | $V_{CC} = 5V$ , $V_{RS+} = 10V$ , $C_{LOAD} = 10pF$ , $V_{SENSE} = -100mV$ to $+100mV$ |                      | 25              |                      | $\mu s$ |
|   |            | $V_{CC} = 5V$ , $V_{RS+} = 10V$ , $C_{LOAD} = 10pF$ , $V_{SENSE} = 1.5V$ to $100mV$    |                      | 25              |                      |         |
| Reference Voltage                                 | $V_{REF}$  | $I_{REF} = 0$ to $100\mu A$ , $T_A = +25^{\circ}C$                                     | 1.20                 | 1.21            | 1.22                 | V       |
|   |            | $I_{REF} = 0$ to $100\mu A$ , $T_A = -40^{\circ}C$ to $+85^{\circ}C$                   | 1.19                 |                 | 1.23                 |         |
| Comparator Input Offset                           |            | Common-mode voltage = REF  |                      | $\pm 0.5$       | $\pm 5$              | mV      |
| Comparator Hysteresis                             |            |  |                      | 5               |                      | mV      |
| Comparator Common-Mode Low                        |            | Functional test  |                      | 0.1             |                      | V       |
| Comparator Common-Mode High                       |            | Functional test  |                      | $V_{CC} - 1.15$ |                      | V       |
| Comparator Input Bias Current                     | $I_{BIAS}$ |  |                      | -2              |                      | nA      |
| Comparator Output Low Voltage                     | $V_{OL}$   | $I_{SINK} = 1mA$   |                      | 0.2             | 0.6                  | V       |
| Comparator Output-High Leakage Current (Note 8)   |            | $V_{PULLUP} = 28V$   |                      |                 | 1                    | $\mu A$ |
| LE Logic Input-High Voltage Threshold             | $V_{IH}$   |  | $0.67 \times V_{CC}$ |                 |                      | V       |
| LE Logic Input-Low Voltage Threshold              | $V_{IL}$   |  |                      |                 | $0.33 \times V_{CC}$ | V       |
| LE Logic Input Internal Pulldown Current          |            |  | 0.68                 | 1               | 2.20                 | $\mu A$ |
| INHIBIT Logic Input-High Voltage Threshold        |            |  | 1.3                  |                 |                      | V       |
| INHIBIT Logic Input-Low Voltage Threshold         |            |  |                      |                 | 0.5                  | V       |
| INHIBIT Logic Input Hysteresis                    |            |  |                      | 0.6             |                      | V       |
| INHIBIT Logic Input Internal Pulldown Current     |            |  | 0.68                 | 1               | 2.20                 | $\mu A$ |

# High-Side Power and Current Monitors

MAX4210/MAX4211

## ELECTRICAL CHARACTERISTICS (continued)

(V<sub>CC</sub> = 5.0V, V<sub>RS+</sub> = 25V, V<sub>SENSE</sub> = 5mV, V<sub>IN</sub> = 1.0V, V<sub>LE</sub> = 0V, R<sub>IOUT</sub> = R<sub>POUT</sub> = 1MΩ, V<sub>CIN1+</sub> = V<sub>CIN2+</sub> = V<sub>REF</sub>, V<sub>CIN1-</sub> = V<sub>CIN2-</sub> = GND, V<sub>INHIBIT</sub> = 0V, R<sub>COUT1</sub> = R<sub>COUT2</sub> = 5kΩ connected to V<sub>CC</sub>, T<sub>A</sub> = -40°C to +85°C, unless otherwise noted. Typical values are at T<sub>A</sub> = +25°C, unless otherwise noted.) (Note 1)

| PARAMETER  | SYMBOL  | CONDITIONS   | MIN   | TYP   | MAX  | UNITS  |
|--|---|--|---|-------|------|--------|
| Comparator Propagation Delay                           | t <sub>PD+</sub> , t <sub>PD-</sub>               | C <sub>LOAD</sub> = 10pF, R <sub>LOAD</sub> = 10kΩ pullup to V <sub>CC</sub> , 5mV overdrive |   | 4     |      | μs     |
| Minimum INHIBIT Pulse Width                            |   |  |   | 1     |      | μs     |
| Minimum LE Pulse Width                                 |   |  |   | 1     |      | μs     |
| Comparator Power-Up Blanking Time From V <sub>CC</sub> | t <sub>ON</sub>                                   | V <sub>CC</sub> from 0 to (2.7V to 5.5V)   |   | 300   |      | μs     |
| LATCH Setup Time                                       | t <sub>SETUP</sub>                                |  |   | 3     |      | μs     |
| <b>MAX4210A/MAX4211A (power gain = 0.667)</b>          |   |  |   |       |      |        |
| POUT Gain Accuracy (Note 9)                            | $\frac{\Delta V_{POUT}}{\Delta V_{SENSE}}$        | V <sub>SENSE</sub> = 10mV to 100mV, V <sub>RS+</sub> = 25V                                   | T <sub>A</sub> = +25°C                                | ±0.5  | ±1.5 | %      |
|  |   |  | T <sub>A</sub> = T <sub>MIN</sub> to T <sub>MAX</sub> |       | ±3.0 |        |
|  | $\frac{\Delta V_{POUT}}{\Delta V_{RS+}}$          | V <sub>SENSE</sub> = 100mV, V <sub>RS+</sub> = 5V to 25V                                     | T <sub>A</sub> = +25°C                                | ±0.5  | ±1.5 |        |
|  |   |  | T <sub>A</sub> = T <sub>MIN</sub> to T <sub>MAX</sub> |       | ±3.0 |        |
| Total POUT Output Error (Note 10)                      | $\frac{\Delta V_{POUT\_MAX}}{FSO}$                | V <sub>SENSE</sub> = 5mV to 100mV, V <sub>RS+</sub> = 5V to 25V                              | T <sub>A</sub> = +25°C                                | ±0.15 | ±1.5 | % FSO* |
|  |   |  | T <sub>A</sub> = T <sub>MIN</sub> to T <sub>MAX</sub> |       | ±3.0 |        |
|  | $\frac{\Delta V_{POUT\_MAX}}{V_{POUT}}$           | V <sub>SENSE</sub> = 150mV, V <sub>RS+</sub> ≥ 15V   | T <sub>A</sub> = +25°C                                | ±0.2  | ±1.5 | %      |
|  |   |  | T <sub>A</sub> = T <sub>MIN</sub> to T <sub>MAX</sub> |       | ±3.0 |        |
|  |   |  | V <sub>SENSE</sub> = 100mV, V <sub>RS+</sub> ≥ 4V     |       | ±2.5 |        |
|  |   |  | V <sub>SENSE</sub> = 100mV, V <sub>RS+</sub> ≥ 9V     |       | ±1.2 |        |
|  | V <sub>SENSE</sub> = 50mV, V <sub>RS+</sub> ≥ 6V  |  | ±1.8  |       |      |        |
|  | V <sub>SENSE</sub> = 25mV, V <sub>RS+</sub> ≥ 15V |  | ±1.8  |       |      |        |
| POUT Output Offset Voltage (Note 11)                   |   | V <sub>SENSE</sub> = 0V, V <sub>RS+</sub> = 25V  | T <sub>A</sub> = +25°C                                | 1.5   | 5    | mV     |
|  |   |  | T <sub>A</sub> = T <sub>MIN</sub> to T <sub>MAX</sub> |       | 15   |        |
| <b>MAX4210B/MAX4211B (power gain = 1.00)</b>           |   |  |   |       |      |        |
| POUT Gain Accuracy (Note 9)                            | $\frac{\Delta V_{POUT}}{\Delta V_{SENSE}}$        | V <sub>SENSE</sub> = 10mV to 100mV, V <sub>RS+</sub> = 25V                                   | T <sub>A</sub> = +25°C                                | ±0.5  | ±1.5 | %      |
|  |   |  | T <sub>A</sub> = T <sub>MIN</sub> to T <sub>MAX</sub> |       | ±3.0 |        |
|  | $\frac{\Delta V_{POUT}}{\Delta V_{RS+}}$          | V <sub>SENSE</sub> = 100mV, V <sub>RS+</sub> = 5V to 25V                                     | T <sub>A</sub> = +25°C                                | ±0.5  | ±1.5 |        |
|  |   |  | T <sub>A</sub> = T <sub>MIN</sub> to T <sub>MAX</sub> |       | ±3.0 |        |

\*FSO refers to full-scale output under the conditions: V<sub>SENSE</sub> = 100mV, V<sub>RS+</sub> = +25V, or V<sub>IN</sub> = 1V.

# High-Side Power and Current Monitors

## ELECTRICAL CHARACTERISTICS (continued)

( $V_{CC} = 5.0V$ ,  $V_{RS+} = 25V$ ,  $V_{SENSE} = 5mV$ ,  $V_{IN} = 1.0V$ ,  $V_{LE} = 0V$ ,  $R_{IOUT} = R_{POUT} = 1M\Omega$ ,  $V_{CIN1+} = V_{CIN2+} = V_{REF}$ ,  $V_{CIN1-} = V_{CIN2-} = GND$ ,  $V_{INHIBIT} = 0V$ ,  $R_{COUT1} = R_{COUT2} = 5k\Omega$  connected to  $V_{CC}$ ,  $T_A = -40^{\circ}C$  to  $+85^{\circ}C$ , unless otherwise noted. Typical values are at  $T_A = +25^{\circ}C$ , unless otherwise noted.) (Note 1)

| PARAMETER                                     | SYMBOL                                   | CONDITIONS   |  | MIN        | TYP       | MAX       | UNITS  |
|---|--|--|--|------------|-----------|-----------|--------|
| Total POUT Output Error<br>(Note 10)          | $\Delta V_{POUT\_MAX}/$<br>FSO           | $V_{SENSE} = 5mV$ to<br>$100mV$ , $V_{RS+} = 5V$ to<br>$25V$ | $T_A = +25^{\circ}C$                                 | $\pm 0.15$ | $\pm 1.5$ | $\pm 3.0$ | % FSO* |
|   |  |  | $T_A = T_{MIN}$ to $T_{MAX}$                         |            |           |           |        |
|   | $\Delta V_{POUT\_MAX}/$<br>$V_{POUT}$    | $V_{SENSE} = 150mV$ ,<br>$V_{RS+} > 15V$                     | $T_A = +25^{\circ}C$<br>$T_A = T_{MIN}$ to $T_{MAX}$ | $\pm 0.2$  | $\pm 1.5$ | $\pm 3.0$ | %      |
|   |  |  |  | $\pm 2.5$  |           |           |        |
|   |  |  |  | $\pm 1.2$  |           |           |        |
|   |  |  |  | $\pm 1.8$  |           |           |        |
| POUT Output Offset Voltage<br>(Note 11)       |  | $V_{SENSE} = 0V$ ,<br>$V_{RS+} = 25V$                        | $T_A = +25^{\circ}C$                                 | 2          | 6.5       | 20        | mV     |
|   |  |  | $T_A = T_{MIN}$ to $T_{MAX}$                         |            |           |           |        |
| <b>MAX4210C/MAX4211C (power gain = 1.64)</b>  |  |  |  |            |           |           |        |
| POUT Gain Accuracy<br>(Note 9)                | $\Delta V_{POUT}/$<br>$\Delta V_{SENSE}$ | $V_{SENSE} = 10mV$ to<br>$100mV$ , $V_{RS+} = 25V$           | $T_A = +25^{\circ}C$                                 | $\pm 0.5$  | $\pm 1.5$ | $\pm 3.0$ | %      |
|   |  |  | $T_A = T_{MIN}$ to $T_{MAX}$                         |            |           |           |        |
|   | $\Delta V_{POUT}/$<br>$\Delta V_{RS+}$   | $V_{SENSE} = 100mV$ ,<br>$V_{RS+} = 5V$ to $25V$             | $T_A = +25^{\circ}C$                                 | $\pm 0.5$  | $\pm 1.5$ | $\pm 3.0$ | %      |
|   |  |  | $T_A = T_{MIN}$ to $T_{MAX}$                         |            |           |           |        |
| Total POUT Output Error<br>(Note 10)          | $\Delta V_{POUT\_MAX}/$<br>FSO           | $V_{SENSE} = 5mV$ to<br>$100mV$ , $V_{RS+} = 5V$<br>to $25V$ | $T_A = +25^{\circ}C$                                 | $\pm 0.15$ | $\pm 1.5$ | $\pm 3.0$ | % FSO* |
|   |  |  | $T_A = T_{MIN}$ to $T_{MAX}$                         |            |           |           |        |
|   | $\Delta V_{POUT\_MAX}/$<br>$V_{POUT}$    | $V_{SENSE} = 100mV$ , $V_{RS+} \geq 4V$                      | $T_A = +25^{\circ}C$<br>$T_A = T_{MIN}$ to $T_{MAX}$ | $\pm 2.5$  |           | $\pm 1.2$ | %      |
|   |  |  |  | $\pm 1.2$  |           |           |        |
|   |  |  | $\pm 1.8$  |            | $\pm 1.8$ | %         |        |
|   |  |  | $\pm 1.8$  |            |           |           |        |
| POUT Output Offset Voltage<br>(Note 11)       |  | $V_{SENSE} = 0V$ ,<br>$V_{RS+} = 25V$                        | $T_A = +25^{\circ}C$                                 | 3          | 10        | 30        | mV     |
|   |  |  | $T_A = T_{MIN}$ to $T_{MAX}$                         |            |           |           |        |
| <b>MAX4210D/MAX4211D (power gain = 16.67)</b> |  |  |  |            |           |           |        |
| POUT Gain Accuracy<br>(Note 9)                | $\Delta V_{POUT}/$<br>$\Delta V_{SENSE}$ | $V_{SENSE} = 10mV$ to<br>$100mV$ , $V_{IN} = 1V$             | $T_A = +25^{\circ}C$                                 | $\pm 0.5$  | $\pm 1.5$ | $\pm 3.0$ | %      |
|   |  |  | $T_A = T_{MIN}$ to $T_{MAX}$                         |            |           |           |        |
|   | $\Delta V_{POUT}/$<br>$\Delta V_{IN}$    | $V_{SENSE} = 100mV$ ,<br>$V_{IN} = 0.2V$ to $1V$             | $T_A = +25^{\circ}C$                                 | $\pm 0.5$  | $\pm 1.5$ | $\pm 3.0$ | %      |
|   |  |  | $T_A = T_{MIN}$ to $T_{MAX}$                         |            |           |           |        |

\*FSO refers to full-scale output under the conditions:  $V_{SENSE} = 100mV$ ,  $V_{RS+} = +25V$ , or  $V_{IN} = 1V$ .

# High-Side Power and Current Monitors

MAX4210/MAX4211

## ELECTRICAL CHARACTERISTICS (continued)

(VCC = 5.0V, VRS+ = 25V, VSENSE = 5mV, VIN = 1.0V, VLE = 0V, RIOUT = RPOUT = 1MΩ, VCIN1+ = VCIN2+ = VREF, VCIN1- = VCIN2- = GND, VINHIBIT = 0V, RCOUT1 = RCOUT2 = 5kΩ connected to VCC, TA = -40°C to +85°C, unless otherwise noted. Typical values are at TA = +25°C, unless otherwise noted.) (Note 1)

| PARAMETER                                     | SYMBOL                             | CONDITIONS  |                   | MIN   | TYP  | MAX  | UNITS  |
|---|------------------------------------|---|-------------------|-------|------|------|--------|
| Total POUT Output Error<br>(Note 10)          | $\Delta V_{POUT\_MAX}/FSO$         | VSENSE = 5mV to 100mV, VRS+ = 25V, VIN = 0.2V to 1V | TA = +25°C        | ±0.15 | ±1.5 | ±3.0 | % FSO* |
|   |                                    |   | TA = TMIN to TMAX |       |      |      |        |
|   | $\Delta V_{POUT\_MAX}/V_{POUT}$    | VSENSE = 150mV, VRS+ = 25V, VIN = 600mV             | TA = +25°C        | ±0.2  | ±1.5 | ±3.0 | %      |
|   |                                    |   | TA = TMIN to TMAX |       |      |      |        |
|   |                                    | VSENSE = 100mV, VRS+ = 15V, VIN ≥ 160mV             |                   |       | ±2.5 |      |        |
|   |                                    | VSENSE = 100mV, VRS+ = 15V, VIN ≥ 360mV             |                   |       | ±1.2 |      |        |
| VSENSE = 50mV, VRS+ = 15V, VIN ≥ 240mV        |                                    |   | ±1.8              |       |      |      |        |
| VSENSE = 25mV, VRS+ = 15V, VIN ≥ 600mV        |                                    |   | ±1.8              |       |      |      |        |
| POUT Output Offset Voltage<br>(Note 11)       |                                    | VSENSE = 0V, VRS+ = 25V, VIN = 1V                   | TA = +25°C        | 1.5   | 5    | 15   | mV     |
|   |                                    |   | TA = TMIN to TMAX |       |      |      |        |
| <b>MAX4210E/MAX4211E (power gain = 25.00)</b> |                                    |   |                   |       |      |      |        |
| POUT Gain Accuracy<br>(Note 9)                | $\Delta V_{POUT}/\Delta V_{SENSE}$ | VSENSE = 10mV to 100mV, VIN = 1V                    | TA = +25°C        | ±0.5  | ±1.5 | ±3.0 | %      |
|   |                                    |   | TA = TMIN to TMAX |       |      |      |        |
| Total POUT Output Error<br>(Note 10)          | $\Delta V_{POUT\_MAX}/FSO$         | VSENSE = 5mV to 100mV, VRS+ = 25V, VIN = 0.2V to 1V | TA = +25°C        | ±0.15 | ±1.5 | ±3.0 | % FSO* |
|   |                                    |   | TA = TMIN to TMAX |       |      |      |        |
|   | $\Delta V_{POUT\_MAX}/V_{POUT}$    | VSENSE = 150mV, VRS+ = 25V, VIN = 600mV             | TA = +25°C        | ±0.2  | ±1.5 | ±3.0 | %      |
|   |                                    |   | TA = TMIN to TMAX |       |      |      |        |
|   |                                    | VSENSE = 100mV, VRS+ = 15V, VIN ≥ 160mV             |                   |       | ±2.5 |      |        |
|   |                                    | VSENSE = 100mV, VRS+ = 15V, VIN ≥ 360mV             |                   |       | ±1.2 |      |        |
| VSENSE = 50mV, VRS+ = 15V, VIN ≥ 240mV        |                                    |   | ±1.8              |       |      |      |        |
| VSENSE = 25mV, VRS+ = 15V, VIN ≥ 600mV        |                                    |   | ±1.8              |       |      |      |        |
| POUT Output Offset Voltage<br>(Note 11)       |                                    | VSENSE = 0V, VRS+ = 25V, VIN = 1V                   | TA = +25°C        | 2     | 6.5  | 20   | mV     |
|   |                                    |   | TA = TMIN to TMAX |       |      |      |        |

\*FSO refers to full-scale output under the conditions: VSENSE = 100mV, VRS+ = +25V, or VIN = 1V.

# High-Side Power and Current Monitors

## ELECTRICAL CHARACTERISTICS (continued)

( $V_{CC} = 5.0V$ ,  $V_{RS+} = 25V$ ,  $V_{SENSE} = 5mV$ ,  $V_{IN} = 1.0V$ ,  $V_{LE} = 0V$ ,  $R_{IOUT} = R_{POUT} = 1M\Omega$ ,  $V_{CIN1+} = V_{CIN2+} = V_{REF}$ ,  $V_{CIN1-} = V_{CIN2-} = GND$ ,  $V_{INHIBIT} = 0V$ ,  $R_{COUT1} = R_{COUT2} = 5k\Omega$  connected to  $V_{CC}$ ,  $T_A = -40^{\circ}C$  to  $+85^{\circ}C$ , unless otherwise noted. Typical values are at  $T_A = +25^{\circ}C$ , unless otherwise noted.) (Note 1)

| PARAMETER                                       | SYMBOL                                     | CONDITIONS   |                              | MIN        | TYP       | MAX | UNITS     |
|---|--|--|------------------------------|------------|-----------|-----|-----------|
| <b>MAX4210F/MAX4211F (power gain = 40.96)</b>   |  |  |                              |            |           |     |           |
| POUT Gain Accuracy<br>(Note 9)                  | $\frac{\Delta V_{POUT}}{\Delta V_{SENSE}}$ | $V_{SENSE} = 10mV$ to $100mV$ , $V_{IN} = 1V$                            | $T_A = +25^{\circ}C$         | $\pm 0.5$  | $\pm 1.5$ |     | %         |
|   |  |  | $T_A = T_{MIN}$ to $T_{MAX}$ |            | $\pm 3.0$ |     |           |
|   | $\frac{\Delta V_{POUT}}{\Delta V_{IN}}$    | $V_{SENSE} = 100mV$ , $V_{IN} = 0.2V$ to $1V$                            | $T_A = +25^{\circ}C$         | $\pm 0.5$  | $\pm 1.5$ |     | %         |
|   |  |  | $T_A = T_{MIN}$ to $T_{MAX}$ |            | $\pm 3.0$ |     |           |
| Total POUT Output Error<br>(Note 10)            | $\frac{\Delta V_{POUT\_MAX}}{FSO}$         | $V_{SENSE} = 5mV$ to $100mV$ , $V_{RS+} = 25V$ , $V_{IN} = 0.2V$ to $1V$ | $T_A = +25^{\circ}C$         | $\pm 0.15$ | $\pm 1.5$ |     | % FSO*    |
|   |  |  | $T_A = T_{MIN}$ to $T_{MAX}$ |            | $\pm 3.0$ |     |           |
|   | $\frac{\Delta V_{POUT\_MAX}}{V_{POUT}}$    | $V_{SENSE} = 100mV$ , $V_{RS+} = 15V$ , $V_{IN} \geq 160mV$              | $T_A = +25^{\circ}C$         | $\pm 2.5$  |           | %   |           |
|   |  |  | $T_A = T_{MIN}$ to $T_{MAX}$ |            |           |     | $\pm 1.2$ |
|   | $\frac{\Delta V_{POUT\_MAX}}{V_{POUT}}$    | $V_{SENSE} = 50mV$ , $V_{RS+} = 15V$ , $V_{IN} \geq 240mV$               | $T_A = +25^{\circ}C$         | $\pm 1.8$  |           | %   |           |
|   |  |  | $T_A = T_{MIN}$ to $T_{MAX}$ |            |           |     | $\pm 1.8$ |
| POUT Output Offset Voltage<br>(Note 11)         |  | $V_{SENSE} = 0V$ , $V_{RS+} = 25V$ , $V_{IN} = 1V$                       | $T_A = +25^{\circ}C$         | 3          | 10        |     | mV        |
|   |  |  | $T_A = T_{MIN}$ to $T_{MAX}$ |            |           |     |           |
| <b>MAX4211A/MAX4211D (current gain = 16.67)</b> |  |  |                              |            |           |     |           |
| IOUT Gain Accuracy                              | $\frac{\Delta V_{IOUT}}{\Delta V_{SENSE}}$ | $V_{SENSE} = 20mV$ to $100mV$ , $V_{RS+} = 25V$                          | $T_A = +25^{\circ}C$         | $\pm 0.5$  | $\pm 1.5$ |     | %         |
|   |  |  | $T_A = T_{MIN}$ to $T_{MAX}$ |            | $\pm 3.0$ |     |           |
| Total IOUT Output Error<br>(Note 10)            | $\frac{\Delta V_{IOUT\_MAX}}{FSO}$         | $V_{SENSE} = 5mV$ to $100mV$   | $T_A = +25^{\circ}C$         | $\pm 0.15$ | $\pm 1.5$ |     | % FSO*    |
|   |  |  | $T_A = T_{MIN}$ to $T_{MAX}$ |            | $\pm 3.0$ |     |           |
|   | $\frac{\Delta V_{IOUT\_MAX}}{V_{IOUT}}$    | $V_{SENSE} = 150mV$  | $T_A = +25^{\circ}C$         | $\pm 0.2$  | $\pm 1.5$ |     | %         |
|   |  |  | $T_A = T_{MIN}$ to $T_{MAX}$ |            | $\pm 3.0$ |     |           |
| $V_{SENSE} = 50mV$                              |  |  | $\pm 1.2$                    |            |           |     |           |
|   | $V_{SENSE} = 25mV$                         | $\pm 1.8$  |                              |            |           |     |           |
|   | $V_{SENSE} = 5mV$                          | $\pm 20$   |                              |            |           |     |           |

\*FSO refers to full-scale output under the conditions:  $V_{SENSE} = 100mV$ ,  $V_{RS+} = +25V$ , or  $V_{IN} = 1V$ .



# High-Side Power and Current Monitors

MAX4210/MAX4211

## ELECTRICAL CHARACTERISTICS (continued)

(V<sub>CC</sub> = 5.0V, V<sub>RS+</sub> = 25V, V<sub>SENSE</sub> = 5mV, V<sub>IN</sub> = 1.0V, V<sub>LE</sub> = 0V, R<sub>IOUT</sub> = R<sub>POUT</sub> = 1MΩ, V<sub>CIN1+</sub> = V<sub>CIN2+</sub> = V<sub>REF</sub>, V<sub>CIN1-</sub> = V<sub>CIN2-</sub> = GND, V<sub>INHIBIT</sub> = 0V, R<sub>COUT1</sub> = R<sub>COUT2</sub> = 5kΩ connected to V<sub>CC</sub>, T<sub>A</sub> = -40°C to +85°C, unless otherwise noted. Typical values are at T<sub>A</sub> = +25°C, unless otherwise noted.) (Note 1)

| PARAMETER                                       | SYMBOL                                     | CONDITIONS   |   | MIN   | TYP  | MAX  | UNITS  |
|---|--|--|---|-------|------|------|--------|
| <b>MAX4211B/MAX4211E (current gain = 25.00)</b> |  |  |   |       |      |      |        |
| IOUT Gain Accuracy                              | $\frac{\Delta V_{IOUT}}{\Delta V_{SENSE}}$ | V <sub>SENSE</sub> = 20mV to 100mV, V <sub>RS+</sub> = 25V | T <sub>A</sub> = +25°C                                | ±0.5  | ±1.5 |      | %      |
|   |  |  | T <sub>A</sub> = T <sub>MIN</sub> to T <sub>MAX</sub> |       |      | ±3.0 |        |
| Total IOUT Output Error (Note 10)               | $\frac{\Delta V_{IOUT\_MAX}}{FSO}$         | V <sub>SENSE</sub> = 5mV to 100mV                          | T <sub>A</sub> = +25°C                                | ±0.15 | ±1.5 |      | % FSO* |
|   |  |  | T <sub>A</sub> = T <sub>MIN</sub> to T <sub>MAX</sub> |       |      | ±3.0 |        |
|   | $\frac{\Delta V_{IOUT\_MAX}}{V_{IOUT}}$    | V <sub>SENSE</sub> = 150mV                                 | T <sub>A</sub> = +25°C                                | ±0.2  | ±1.5 |      | %      |
|   |  |  | T <sub>A</sub> = T <sub>MIN</sub> to T <sub>MAX</sub> |       |      | ±3.0 |        |
|   |  |  | V <sub>SENSE</sub> = 50mV                             |       | ±1.2 |      |        |
|   |  |  | V <sub>SENSE</sub> = 25mV                             |       | ±1.8 |      |        |
|   | V <sub>SENSE</sub> = 5mV                   |  | ±20   |       |      |      |        |
| <b>MAX4211C/MAX4211F (current gain = 40.96)</b> |  |  |   |       |      |      |        |
| IOUT Gain Accuracy                              | $\frac{\Delta V_{IOUT}}{\Delta V_{SENSE}}$ | V <sub>SENSE</sub> = 20mV to 100mV, V <sub>RS+</sub> = 25V | T <sub>A</sub> = +25°C                                | ±0.5  | ±1.5 |      | %      |
|   |  |  | T <sub>A</sub> = T <sub>MIN</sub> to T <sub>MAX</sub> |       |      | ±3.0 |        |
| Total IOUT Output Error (Note 10)               | $\frac{\Delta V_{IOUT\_MAX}}{FSO}$         | V <sub>SENSE</sub> = 5mV to 100mV                          | T <sub>A</sub> = +25°C                                | ±0.15 | ±1.5 |      | % FSO* |
|   |  |  | T <sub>A</sub> = T <sub>MIN</sub> to T <sub>MAX</sub> |       |      | ±3.0 |        |
|   | $\frac{\Delta V_{IOUT\_MAX}}{V_{IOUT}}$    | V <sub>SENSE</sub> = 100mV                                 | T <sub>A</sub> = +25°C                                | ±0.2  | ±1.5 |      | %      |
|   |  |  | T <sub>A</sub> = T <sub>MIN</sub> to T <sub>MAX</sub> |       |      | ±3.0 |        |
|   |  |  | V <sub>SENSE</sub> = 50mV                             |       | ±1.2 |      |        |
|   |  |  | V <sub>SENSE</sub> = 25mV                             |       | ±1.8 |      |        |
|   | V <sub>SENSE</sub> = 5mV                   |  | ±20   |       |      |      |        |

\*FSO refers to full-scale output under the conditions: V<sub>SENSE</sub> = 100mV, V<sub>RS+</sub> = +25V, or V<sub>IN</sub> = 1V.

- Note 1:** All devices are 100% production tested at T<sub>A</sub> = +25°C. All temperature limits are guaranteed by design.
- Note 2:** Guaranteed by power-supply rejection test.
- Note 3:** Guaranteed by output voltage error tests (IOUT).
- Note 4:** Guaranteed by output voltage error tests (IOUT or POUT, or both).
- Note 5:** IN Input Voltage Range (MAX421\_D/E/F) and V<sub>RS+</sub> Input Voltage Range (MAX421\_A/B/C) are guaranteed by design (GBD) and not production tested. See Multiplier Transfer Characteristics graphs in the *Typical Operating Characteristics*.
- Note 6:** This test does not apply to the low gain options, MAX421\_A/D, because OUT is clamped at approximately 4V.
- Note 7:** The device does not experience phase reversal when overdriven.
- Note 8:** V<sub>PULLUP</sub> is defined as an externally applied voltage through a resistor, R<sub>PULLUP</sub>, to pull up the comparator output.
- Note 9:** POUT gain accuracy is the sum of gain error and multiplier nonlinearity.
- Note 10:** Total output voltage error is the sum of gain and offset voltage errors.
- Note 11:** POUT Output Offset Voltage is the sum of offset and multiplier feedthrough.

# High-Side Power and Current Monitors

## Typical Operating Characteristics

( $V_{CC} = 5.0V$ ,  $V_{RS+} = 25V$ ,  $V_{SENSE} = 100mV$ ,  $V_{IN} = 1V$ ,  $V_{LE} = 0V$ ,  $R_{IOUT} = R_{POUT} = 1M\Omega$ ,  $V_{CIN1+} = V_{CIN2+} = V_{REF}$ ,  $V_{CIN1-} = V_{CIN2-} = 0V$ ,  $V_{INHIBIT} = 0V$ ,  $R_{COUT1} = R_{COUT2} = 5k\Omega$  connected to  $V_{CC}$ ,  $T_A = +25^\circ C$ , unless otherwise noted.)



# High-Side Power and Current Monitors

MAX4210/MAX4211

## Typical Operating Characteristics (continued)

( $V_{CC} = 5.0V$ ,  $V_{RS+} = 25V$ ,  $V_{SENSE} = 100mV$ ,  $V_{IN} = 1V$ ,  $V_{LE} = 0V$ ,  $R_{IOUT} = R_{POUT} = 1M\Omega$ ,  $V_{CIN1+} = V_{CIN2+} = V_{REF}$ ,  $V_{CIN1-} = V_{CIN2-} = 0V$ ,  $V_{INHIBIT} = 0V$ ,  $R_{COUT1} = R_{COUT2} = 5k\Omega$  connected to  $V_{CC}$ ,  $T_A = +25^\circ C$ , unless otherwise noted.)

**CURRENT OUTPUT ERROR vs. SENSE VOLTAGE**



**POWER OUTPUT ERROR vs.  $V_{RS+}$**



**POWER OUTPUT ERROR vs. IN VOLTAGE**



**POWER GAIN vs. TEMPERATURE**



**CURRENT GAIN vs. TEMPERATURE**



**MULTIPLIER TRANSFER CHARACTERISTICS**



**MULTIPLIER TRANSFER CHARACTERISTICS**



**MULTIPLIER TRANSFER CHARACTERISTICS**



**REFERENCE VOLTAGE vs. SUPPLY VOLTAGE**



# High-Side Power and Current Monitors

## Typical Operating Characteristics (continued)

( $V_{CC} = 5.0V$ ,  $V_{RS+} = 25V$ ,  $V_{SENSE} = 100mV$ ,  $V_{IN} = 1V$ ,  $V_{LE} = 0V$ ,  $R_{IOUT} = R_{POUT} = 1M\Omega$ ,  $V_{CIN1+} = V_{CIN2+} = V_{REF}$ ,  $V_{CIN1-} = V_{CIN2-} = 0V$ ,  $V_{INHIBIT} = 0V$ ,  $R_{COUT1} = R_{COUT2} = 5k\Omega$  connected to  $V_{CC}$ ,  $T_A = +25^\circ C$ , unless otherwise noted.)

REFERENCE VOLTAGE vs. TEMPERATURE

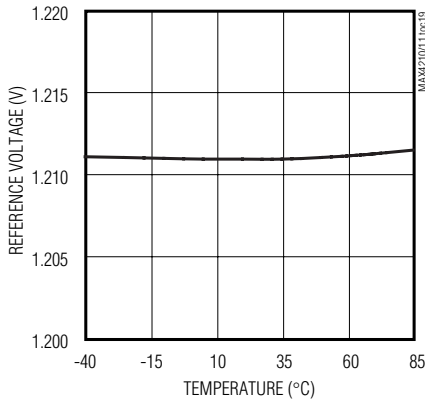

COMPARATOR PROPAGATION DELAY vs. OVERDRIVE VOLTAGE

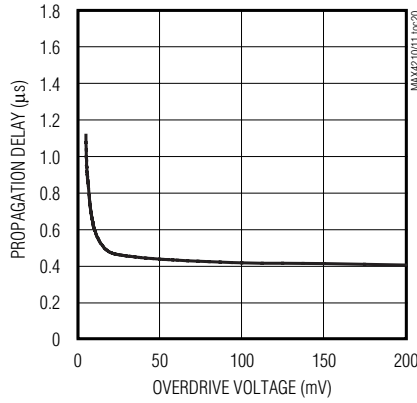

COMPARATOR PROPAGATION DELAY vs. TEMPERATURE

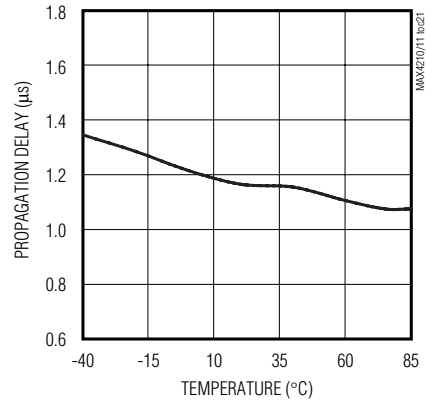

COMPARATOR OUTPUT VOLTAGE (V<sub>OL</sub>) vs. CURRENT SINK

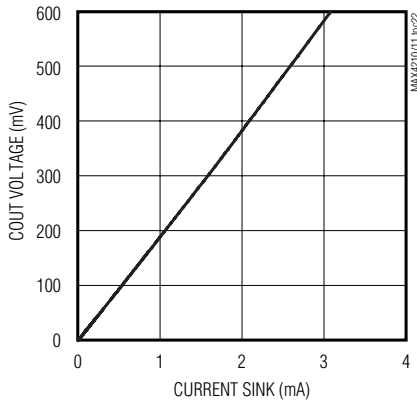

COMPARATOR OUTPUT VOLTAGE (V<sub>OL</sub>) vs. TEMPERATURE

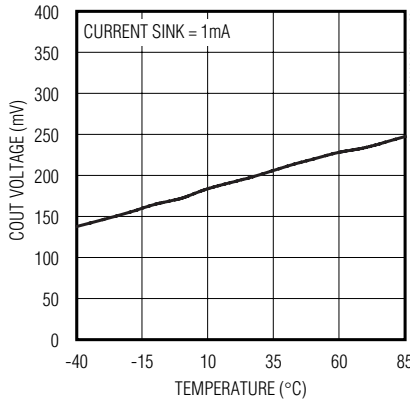

COMPARATOR POWER-UP DELAY

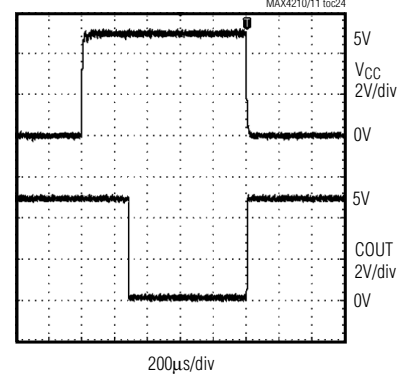

COMPARATOR PROPAGATION DELAY

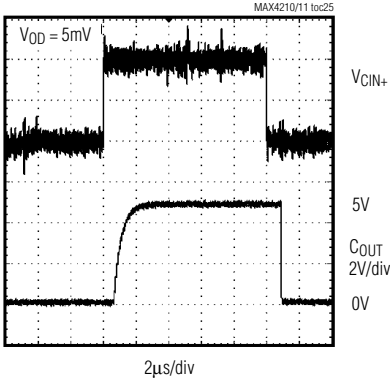

COMPARATOR AC RESPONSE

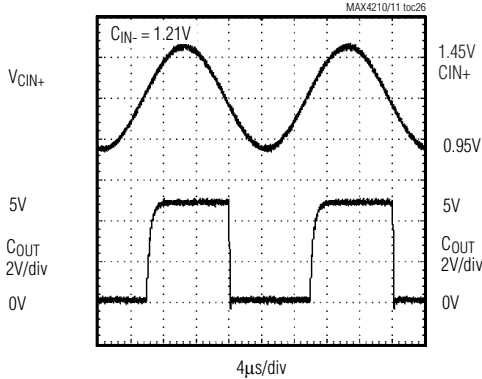

POUT POWER-UP DELAY

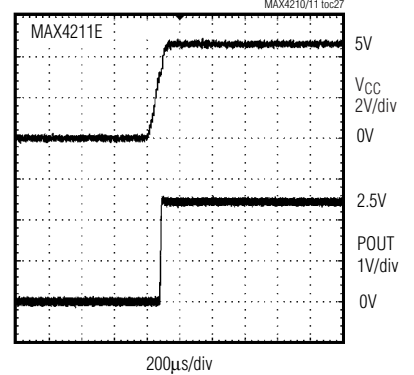

# High-Side Power and Current Monitors

MAX4210/MAX4211

## Typical Operating Characteristics (continued)

( $V_{CC} = 5.0V$ ,  $V_{RS+} = 25V$ ,  $V_{SENSE} = 100mV$ ,  $V_{IN} = 1V$ ,  $V_{LE} = 0V$ ,  $R_{IOUT} = R_{POUT} = 1M\Omega$ ,  $V_{CIN1+} = V_{CIN2+} = V_{REF}$ ,  $V_{CIN1-} = V_{CIN2-} = 0V$ ,  $V_{INHIBIT} = 0V$ ,  $R_{COUT1} = R_{COUT2} = 5k\Omega$  connected to  $V_{CC}$ ,  $T_A = +25^\circ C$ , unless otherwise noted.)



# High-Side Power and Current Monitors

## Typical Operating Characteristics (continued)

( $V_{CC} = 5.0V$ ,  $V_{RS+} = 25V$ ,  $V_{SENSE} = 100mV$ ,  $V_{IN} = 1V$ ,  $V_{LE} = 0V$ ,  $R_{IOUT} = R_{POUT} = 1M\Omega$ ,  $V_{CIN1+} = V_{CIN2+} = V_{REF}$ ,  $V_{CIN1-} = V_{CIN2-} = 0V$ ,  $V_{INHIBIT} = 0V$ ,  $R_{COUT1} = R_{COUT2} = 5k\Omega$  connected to  $V_{CC}$ ,  $T_A = +25^\circ C$ , unless otherwise noted.)

**IOUT SMALL-SIGNAL PULSE RESPONSE**



**POUT LARGE-SIGNAL PULSE RESPONSE**



**IOUT LARGE-SIGNAL PULSE RESPONSE**



**POUT SLEW-RATE PULSE RESPONSE**



**IOUT SLEW-RATE PULSE RESPONSE**



**POUT COMMON-MODE REJECTION RATIO vs. FREQUENCY**



# High-Side Power and Current Monitors

MAX4210/MAX4211

## Typical Operating Characteristics (continued)

( $V_{CC} = 5.0V$ ,  $V_{RS+} = 25V$ ,  $V_{SENSE} = 100mV$ ,  $V_{IN} = 1V$ ,  $V_{LE} = 0V$ ,  $R_{IOUT} = R_{POUT} = 1M\Omega$ ,  $V_{CIN1+} = V_{CIN2+} = V_{REF}$ ,  $V_{CIN1-} = V_{CIN2-} = 0V$ ,  $V_{INHIBIT} = 0V$ ,  $R_{COUT1} = R_{COUT2} = 5k\Omega$  connected to  $V_{CC}$ ,  $T_A = +25^\circ C$ , unless otherwise noted.)

**IOUT COMMON-MODE REJECTION RATIO vs. FREQUENCY**



**POWER-SUPPLY REJECTION vs. FREQUENCY**



**POUT SMALL-SIGNAL GAIN vs. FREQUENCY**



**IOUT SMALL-SIGNAL GAIN vs. FREQUENCY**



**POUT LARGE-SIGNAL GAIN vs. FREQUENCY**



**IOUT LARGE-SIGNAL GAIN vs. FREQUENCY**



**IN SMALL-SIGNAL GAIN vs. FREQUENCY**



# High-Side Power and Current Monitors

## MAX4210A/B/C Pin Description

| PIN    |             | NAME            | FUNCTION  |
|--------|-------------|-----------------|---|
| 6 TDFN | 8 $\mu$ MAX |                 |   |
| 1      | 1           | GND             | Ground  |
| 2      | 2, 3, 6     | N.C.            | No Connection. Not internally connected.  |
| 3      | 4           | V <sub>CC</sub> | Power-Supply Voltage. Connect a 0.1 $\mu$ F bypass capacitor from V <sub>CC</sub> to GND.                     |
| 4      | 5           | RS+             | Power Connection to External-Sense Resistor and Internal Resistor-Divider                                     |
| 5      | 7           | RS-             | Load-Side Connection for External-Sense Resistor  |
| 6      | 8           | POUT            | Power Output Voltage. Voltage output proportional to source power (input voltage multiplied by load current). |
| EP     | —           | EP*             | Exposed Paddle. EP is internally connected to GND.  |

\*TDFN package only.

## MAX4210D/E/F Pin Description

| PIN    |             | NAME            | FUNCTION  |
|--------|-------------|-----------------|---|
| 6 TDFN | 8 $\mu$ MAX |                 |   |
| 1      | 1           | GND             | Ground  |
| 2      | 2           | IN              | Multiplier Input Voltage. Voltage input for internal multiplier.  |
| 3      | 4           | V <sub>CC</sub> | Power-Supply Voltage. Connect a 0.1 $\mu$ F bypass capacitor from V <sub>CC</sub> to GND.                     |
| 4      | 5           | RS+             | Power Connection to External-Sense Resistor   |
| 5      | 7           | RS-             | Load-Side Connection for External-Sense Resistor  |
| 6      | 8           | POUT            | Power Output Voltage. Voltage output proportional to source power (input voltage multiplied by load current). |
| EP     | —           | EP*             | Exposed Paddle. EP is internally connected to GND.  |
| —      | 3, 6        | N.C.            | No Connection. Not internally connected.  |

\*TDFN package only.



# High-Side Power and Current Monitors

## MAX4211A/B/C Pin Description

**MAX4210/MAX4211**

| PIN         |          | NAME            | FUNCTION   |
|-------------|----------|-----------------|--|
| 16 THIN QFN | 16 TSSOP |                 |  |
| 1           | 3        | V <sub>CC</sub> | Power-Supply Voltage. Connect a 0.1μF bypass capacitor from V <sub>CC</sub> to GND.  |
| 2           | 4        | N.C.            | No Connection. Not internally connected.   |
| 3           | 5        | LE              | Latch Enable for Comparator 1. Driving logic low makes the comparator transparent (regular comparator). Driving logic high latches the output. |
| 4           | 6        | COU1            | Open-Drain Comparator 1 Output. LE and INHIBIT control the comparator 1 output.  |
| 5           | 7        | INHIBIT         | INHIBIT for Comparator 1 Output. Driving logic high inhibits the comparator operation. Drive logic low for normal operation.                   |
| 6           | 8        | COU2            | Open-Drain Comparator 2 Output   |
| 7           | 9        | GND             | Ground   |
| 8           | 10       | CIN2+           | Comparator 2 Positive Input  |
| 9           | 11       | CIN2-           | Comparator 2 Negative Input  |
| 10          | 12       | CIN1+           | Comparator 1 Positive Input  |
| 11          | 13       | CIN1-           | Comparator 1 Negative Input  |
| 12          | 14       | REF             | 1.21V Internal Reference Output  |
| 13          | 15       | POUT            | Power Output Voltage. Voltage output proportional to source power (input voltage multiplied by load current).                                  |
| 14          | 16       | IOUT            | Current Output Voltage. Voltage output proportional to V <sub>SENSE</sub> (V <sub>RS+</sub> - V <sub>RS-</sub> ) load current.                 |
| 15          | 1        | RS-             | Load-Side Connection for External-Sense Resistor   |
| 16          | 2        | RS+             | Power Connection to External-Sense Resistor and Internal Resistor-Divider  |
| EP          | —        | EP*             | Exposed Paddle. EP is internally connected to GND.   |

\*Thin QFN package only.

# High-Side Power and Current Monitors

## MAX4211D/E/F Pin Description

| PIN         |          | NAME            | FUNCTION   |
|-------------|----------|-----------------|--|
| 16 THIN QFN | 16 TSSOP |                 |  |
| 1           | 3        | V <sub>CC</sub> | Power-Supply Voltage. Connect a 0.1μF bypass capacitor from V <sub>CC</sub> to GND.  |
| 2           | 4        | IN              | Multiplier Input Voltage. Voltage input for internal multiplier.   |
| 3           | 5        | LE              | Latch Enable for Comparator 1. Driving logic low makes the comparator transparent (regular comparator). Driving logic high latches the output. |
| 4           | 6        | COU1            | Open-Drain Comparator 1 Output. Output controlled by LE and INHIBIT.   |
| 5           | 7        | INHIBIT         | INHIBIT for Comparator 1 Output. Driving logic high inhibits the comparator operation. Drive logic low for normal operation.                   |
| 6           | 8        | COU2            | Open-Drain Comparator 2 Output   |
| 7           | 9        | GND             | Ground   |
| 8           | 10       | CIN2+           | Comparator 2 Positive Input  |
| 9           | 11       | CIN2-           | Comparator 2 Negative Input  |
| 10          | 12       | CIN1+           | Comparator 1 Positive Input  |
| 11          | 13       | CIN1-           | Comparator 1 Negative Input  |
| 12          | 14       | REF             | 1.21V Internal Reference Output  |
| 13          | 15       | POUT            | Power Output Voltage. Voltage output proportional source power (input voltage multiplied by load current).                                     |
| 14          | 16       | IOUT            | Current Output Voltage. Voltage output proportional V <sub>SENSE</sub> (V <sub>RS+</sub> - V <sub>RS-</sub> ) load current.                    |
| 15          | 1        | RS-             | Load-Side Connection for External-Sense Resistor   |
| 16          | 2        | RS+             | Power Connection to External-Sense Resistor  |
| EP          | —        | EP*             | Exposed Paddle. EP is internally connected to GND.   |

\*Thin QFN package only.

## Functional Diagrams

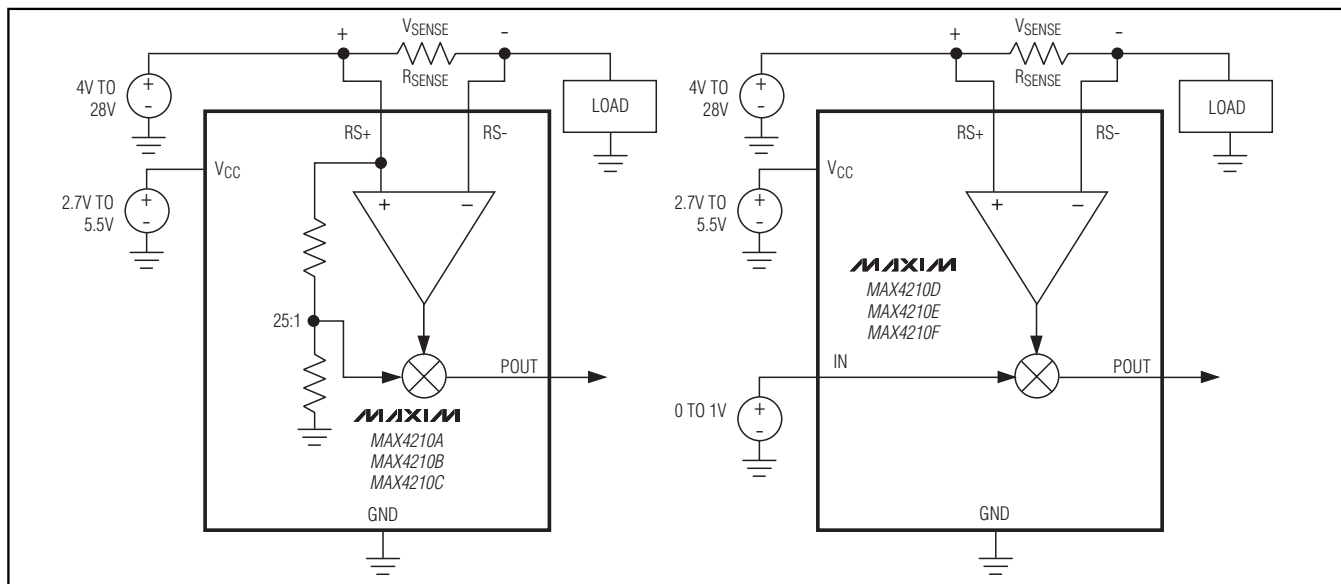

# High-Side Power and Current Monitors

## Functional Diagrams (continued)

MAX4210/MAX4211



### Detailed Description

The MAX4210/MAX4211 families of current- and power-monitoring ICs integrate a precision current-sense amplifier and an analog multiplier for a variety of current and power measurements. The MAX4211 integrates an additional uncommitted 1.21V reference and two comparators with open-drain outputs. These features enable the design of detector circuits for over-power, overcurrent, overvoltage, or any combination of fault conditions. The MAX4210/MAX4211 offer various gains, packages, and configurations allowing for greater design flexibility and lower overall cost.

These devices monitor the load current with their high-side current-sense amplifiers and provide an analog

output voltage proportional to that current at IOUT (MAX4211). This voltage is fed to the analog multiplier for multiplying the load current with a source voltage to obtain a voltage proportional to load power at POUT.

### Current-Sense Amplifier

The integrated current-sense amplifier is a differential amplifier that amplifies the voltage across RS+ and RS-. A sense resistor, R<sub>SENSE</sub>, is connected across RS+ and RS-. A voltage drop across R<sub>SENSE</sub> is developed when a load current is passed through it. This voltage is amplified and is proportional to the load current. This voltage is also fed to the analog multiplier for power-sensing applications (see the *Analog Multiplier* section). The current-sense amplifiers feature three gain options: 16.67V/V, 25.0V/V, and 40.96V/V (see Table 1).

## High-Side Power and Current Monitors

The common-mode voltage range is +4V to +28V and independent of the supply voltage. With this feature, the device can monitor the output current of a high-voltage source while running at a lower system voltage typically between 2.7V and 5.5V.

The MAX4211 has a current-sense amplifier output. The voltage at IOOUT is proportional to the voltage across  $V_{SENSE}$ :

$$V_{IOUT} = A_{VIOUT} \times V_{SENSE}$$

where  $V_{SENSE}$  is the voltage across  $RS+$  and  $RS-$ , and  $A_{VIOUT}$  is the amplifier gain of the device given in Table 1.

### Analog Multiplier

The MAX4210/MAX4211 integrate an analog multiplier that enables real-time monitoring of power delivered to a load. The voltage proportional to the load current is fed to one input of the multiplier and a voltage proportional to the source voltage is fed to the other. The analog multiplier multiplies these two voltages to obtain an output voltage proportional to the load power. The analog multiplier is designed only to operate in the positive quadrant, that is, the inputs and outputs are always positive voltages.

For the MAX4210D/E/F and MAX4211D/E/F, the analog multiplier full-scale input at  $IN$  is approximately 1V. This independent multiplier input allows greater design flexibility when using an external voltage-divider. For the MAX4210A/B/C and MAX4211A/B/C, an integrated voltage-divider divides the source voltage at the  $RS+$  pin by a nominal value of 25 and passes this voltage to the multiplier. Thus, the full-scale input voltage at  $RS+$  is 25V. The integrated, trimmed resistor-dividers reduce external component count and cost.

The voltage output at  $POUT$  is proportional to the output power:

For the MAX4210A/B/C and MAX4211A/B/C:

$$V_{POUT} = A_{VPOUT} \times V_{SENSE} \times V_{RS+}$$

For the MAX4210D/E/F and MAX4211D/E/F:

$$V_{POUT} = A_{VPOUT} \times V_{SENSE} \times V_{IN}$$

**Table 1. MAX4211 Current-Sense Amplifier Gain and Full-Scale Sense Voltage**

| PART       | CURRENT-SENSE AMPLIFIER GAIN ( $A_{VIOUT}$ , V/V) | FULL-SCALE SENSE VOLTAGE (mV) |
|------------|---|-------------------------------|
| MAX4211A/D | 16.67   | 150                           |
| MAX4211B/E | 25.00   | 150                           |
| MAX4211C/F | 40.96   | 100                           |

where  $V_{SENSE}$  is the voltage across  $RS+$  and  $RS-$  and  $A_{VPOUT}$  is the amplifier gain of the device given in Table 2.

### Internal Comparators (MAX4211)

The MAX4211 features two uncommitted open-drain output comparators. These comparators can be configured to trip when load current or power reaches a set limit. They can also be configured as a window comparator with wire-OR output. Comparator 1 (COOUT1) features latch-enable (LE) and inhibit (INHIBIT) inputs. When LE is low, the comparator is transparent (it functions as a regular unlatched comparator). When LE is high, the comparator output (COOUT1) is latched. When high, the INHIBIT input suspends the comparator operation and latches the output to the current state. The operation of INHIBIT is similar to LE, except it has a different input threshold and wider hysteresis. The INHIBIT logic-high threshold is 1.21V and logic-low threshold is 0.6V with 0.6V hysteresis. INHIBIT is useful in preventing the comparator from giving false output during fast  $RS+$  transients. INHIBIT is generally triggered by an RC network connected to  $RS+$  (see the *Applications Information*). Both comparators have a built-in 300 $\mu$ s blanking period at power-up to prevent false outputs. The comparator outputs are open drain and they can be pulled up to  $V_{CC}$ ,  $RS+$ , or any voltage less than +28V. LE and INHIBIT are internally pulled down by a 1 $\mu$ A source.

**Table 2. MAX4210/MAX4211 Power-Sense Amplifier Gain and Full-Scale Sense Voltage**

| PART     | POWER-SENSE AMPLIFIER GAIN ( $A_{VPOUT}$ , 1/V) | FULL-SCALE SENSE VOLTAGE (mV) |
|----------|---|-------------------------------|
| MAX4210A | 0.667   | 150                           |
| MAX4210B | 1.000   | 150                           |
| MAX4210C | 1.640   | 100                           |
| MAX4210D | 16.670  | 150                           |
| MAX4210E | 25.000  | 150                           |
| MAX4210F | 40.960  | 100                           |
| MAX4211A | 0.667   | 150                           |
| MAX4211B | 1.000   | 150                           |
| MAX4211C | 1.640   | 100                           |
| MAX4211D | 16.670  | 150                           |
| MAX4211E | 25.000  | 150                           |
| MAX4211F | 40.960  | 100                           |

# High-Side Power and Current Monitors

## Internal Reference (MAX4211)

The MAX4211 features a 1.21V bandgap reference output, stable over supply voltage and temperature. Typically, the reference output is connected to one of

the comparators' inputs. This is the comparison reference voltage. If a lower reference voltage is needed, use an external voltage-divider. The reference can source or sink a load current up to 100 $\mu$ A.

## Typical Operating Circuit



MAX4210/MAX4211

# High-Side Power and Current Monitors

## Applications Information

### Recommended Component Values

Ideally, the maximum load current develops the full-scale sense voltage across the current-sense resistor. Choose the gain version needed to yield the maximum current-sense amplifier output voltage without saturating it. The typical high-side saturation voltage is about  $V_{CC} - 0.25V$ . The current-sense amplifier output voltage is given by:

$$V_{IOUT} = V_{SENSE} \times A_{V_{IOUT}}$$

where  $V_{IOUT}$  is the voltage fed to the analog multiplier or at IOUT.  $V_{SENSE}$  is the sense voltage.  $A_{V_{IOUT}}$  is the current-sense amplifier gain of the device specified in Table 1. Calculate the maximum value for  $R_{SENSE}$  so the differential voltage across RS+ and RS- does not exceed the full-scale sense voltage:

$$R_{SENSE} = \frac{V_{SENSE(FULL-SCALE)}}{I_{LOAD(FULL-SCALE)}}$$

Choose the highest value resistance possible to maximize  $V_{SENSE}$  and thus minimize total output error. In applications monitoring high current, ensure that  $R_{SENSE}$  is able to dissipate its own  $I^2R$  power dissipation. If the resistor's power dissipation is exceeded, its value can drift or it can fail altogether, causing a differential voltage across the terminals in excess of the absolute maximum ratings. Use resistors specified for current-sensing applications.

### Window Comparator

In some applications where undercurrent or underpower (open-circuit fault) and overcurrent or overpower (short-circuit fault) needs to be monitored, a window comparator is desirable. Figure 1 shows a simple circuit suitable for window detection. Let  $P_{OVER}$  be the minimum load power required to cause a low state at COUT2, and let  $P_{UNDER}$  be the maximum load current required to cause a high state at COUT1:

$$P_{UNDER(WATTS)} = \frac{V_{REF}}{A_{V_{POUT}} \times R_{SENSE}} \left( \frac{R_1 + R_2}{R_2} \right)$$

$$P_{OVER(WATTS)} = \frac{V_{REF}}{A_{V_{POUT}} \times R_{SENSE}} \left( \frac{R_4 + R_5}{R_5} \right)$$

where  $A_{V_{POUT}}$  is the power-sense amplifier gain given in Table 2, and  $V_{REF}$  is the internal reference voltage (1.2V, typ). The resulting comparator output is high

when the current is inside the current window and low when the current is outside the window. Note that COUT1 and COUT2 are wire-ORed together.

### Overpower Circuit Breaker

Figure 2 shows a circuit breaker that shuts off current to the load when an overpower fault is detected (the same circuit can be used to detect overcurrent conditions by connecting the R1-R2 resistor-divider to IOUT, instead of POUT). This circuit is useful for protecting the battery from short-circuit or overpower conditions. When a power fault is detected, the P-MOSFET, M1, is turned off and stays off until the manual reset button is pressed. Also, cycling the input power causes the LE pin to go low, which unlatches the comparator output OUT1 and resets the circuit breaker.

During power-up or when the characteristics of the load change, there can be an inrush current into the load. The temporary inrush current results in a higher voltage at POUT. This can bring the voltage at CIN+ above the reference voltage at CIN-, and, as a result, COUT1 goes high triggering the circuit-breaker function. This unwanted behavior can be disabled by bringing comparator 1's INHIBIT input high. An RC network connected to INHIBIT (R4 and C1) can be incorporated to suspend comparator 1's operation for a brief period. In this way, short surges in load power can be made invisible to the circuit-breaker function, while longer term overpower load demands (or a load short circuit) still "trip the breaker."

The logic-high threshold for INHIBIT is typically 1.2V, and the logic-low threshold is 0.6V. During power-up, INHIBIT quickly exceeds 1.2V through C1 and inhibits COUT1 from changing state. The comparator inputs are "inhibited" until the INHIBIT voltage is discharged to 0.6V. R3 is a current-limiting resistor, typically 10k $\Omega$ , which protects the INHIBIT input. Since INHIBIT is a high-impedance input, R3 has no effect on the R4-C1 charge/discharge time. The time during which the comparator is suspended is approximated by:

$$t_{INHIBIT} = R_4 \times C_1 \ln \left( \frac{\Delta V}{0.6V} \right)$$

where  $\Delta V$  is the voltage change at the load. For improved transient immunity,  $t_{INHIBIT}$  can be increased as required, with the understanding that the breaker function will be suspended for this period.

If any comparator is not used, its input must be biased to a known state. For example, connect CIN+ to  $V_{CC}$  and CIN- to GND.

# High-Side Power and Current Monitors

MAX4210/MAX4211



Figure 1. Window Comparator for Detecting Underpower and Overpower Faults (Also Detects Undercurrent and Overcurrent Faults by R1 and R4 to IOUT Instead of POUT)

## Variable-Gain Amplifier

Figure 3 shows single-ended input, variable-gain amplifiers (VGA). This VGA features more than 200kHz bandwidth and is useful in automatic gain-control circuits commonly found in baseband processors. The gain is controlled by applying 0 to 1V to IN ( $V_{GC}$ ) of the MAX4210D/E/F; 0V corresponds to minimum gain and 1V corresponds to maximum gain.

## Measure Load Power

The MAX4210A/B/C and MAX4211A/B/C have internal voltage-divider resistors connected to RS+ and the analog multiplier input. This configuration measures source power accurately and provides protection to the power source such as a battery. To measure the load

power accurately, choose the MAX4210D/E/F and MAX4211D/E/F with an external resistor-divider connected directly to the load as shown in Figure 4. This configuration improves the load-power measurement accuracy by excluding the additional power dissipated by RSENSE.

## Power-Supply Bypassing

Bypass  $V_{CC}$  to GND with a 0.1 $\mu$ F ceramic capacitor to isolate the IC from supply-voltage transients. To prevent high-frequency coupling, bypass RS+ or RS- with a 0.1 $\mu$ F capacitor. On the TDFN and thin QFN packages, there is an exposed paddle that does not carry any current, but should also be connected to the ground plane for rated power dissipation.

# High-Side Power and Current Monitors



Figure 2. Overpower Circuit Breaker (For a Detailed Example, Refer to the MAX4211E EV Kit)



# High-Side Power and Current Monitors

MAX4210/MAX4211



Figure 3. Single-Ended-Input, Variable-Gain Amplifier



Figure 4. Load-Power Measurement with External Voltage-Divider

# High-Side Power and Current Monitors

## Selector Guide

**MAX4210/MAX4211**

| PART        | PIN-PACKAGE | CURRENT GAIN (V/V) | POWER GAIN (1/V) | CURRENT/POWER MEASUREMENT OUTPUT | NO. OF COMPARATORS | INTERNAL REFERENCE | VOLTAGE-MULTIPLIER INPUT (INTERNAL RESISTOR-DIVIDER/EXTERNAL INPUT) | FULL-SCALE V <sub>SENSE</sub> VOLTAGE (mV) |
|-------------|-------------|--------------------|------------------|----------------------------------|--------------------|--------------------|---|--|
| MAX4210AETT | 6 TDFN      | —                  | 0.667            | P                                | None               | N                  | INT   | 150  |
| MAX4210AEUA | 8 μMAX      | —                  | 0.667            | P                                | None               | N                  | INT   | 150  |
| MAX4210BETT | 6 TDFN      | —                  | 1.000            | P                                | None               | N                  | INT   | 150  |
| MAX4210BEUA | 8 μMAX      | —                  | 1.000            | P                                | None               | N                  | INT   | 150  |
| MAX4210CETT | 6 TDFN      | —                  | 1.640            | P                                | None               | N                  | INT   | 100  |
| MAX4210CEUA | 8 μMAX      | —                  | 1.640            | P                                | None               | N                  | INT   | 100  |
| MAX4210DETT | 6 TDFN      | —                  | 16.670           | P                                | None               | N                  | EXT   | 150  |
| MAX4210DEUA | 8 μMAX      | —                  | 16.670           | P                                | None               | N                  | EXT   | 150  |
| MAX4210EETT | 6 TDFN      | —                  | 25.000           | P                                | None               | N                  | EXT   | 150  |
| MAX4210EEUA | 8 μMAX      | —                  | 25.000           | P                                | None               | N                  | EXT   | 150  |
| MAX4210FETT | 6 TDFN      | —                  | 40.960           | P                                | None               | N                  | EXT   | 100  |
| MAX4210FEUA | 8 μMAX      | —                  | 40.960           | P                                | None               | N                  | EXT   | 100  |
| MAX4211AETE | 16 Thin QFN | 16.67              | 0.667            | C/P                              | 2                  | Y                  | INT   | 150  |
| MAX4211AEUE | 16 TSSOP    | 16.67              | 0.667            | C/P                              | 2                  | Y                  | INT   | 150  |
| MAX4211BETE | 16 Thin QFN | 25.00              | 1.000            | C/P                              | 2                  | Y                  | INT   | 150  |
| MAX4211BEUE | 16 TSSOP    | 25.00              | 1.000            | C/P                              | 2                  | Y                  | INT   | 150  |
| MAX4211CETE | 16 Thin QFN | 40.96              | 1.640            | C/P                              | 2                  | Y                  | INT   | 100  |
| MAX4211CEUE | 16 TSSOP    | 40.96              | 1.640            | C/P                              | 2                  | Y                  | INT   | 100  |
| MAX4211DETE | 16 Thin QFN | 16.67              | 16.670           | C/P                              | 2                  | Y                  | EXT   | 150  |
| MAX4211DEUE | 16 TSSOP    | 16.67              | 16.670           | C/P                              | 2                  | Y                  | EXT   | 150  |
| MAX4211EETE | 16 Thin QFN | 25.00              | 25.000           | C/P                              | 2                  | Y                  | EXT   | 150  |
| MAX4211EEUE | 16 TSSOP    | 25.00              | 25.000           | C/P                              | 2                  | Y                  | EXT   | 150  |
| MAX4211FETE | 16 Thin QFN | 40.96              | 40.960           | C/P                              | 2                  | Y                  | EXT   | 100  |
| MAX4211FEUE | 16 TSSOP    | 40.96              | 40.960           | C/P                              | 2                  | Y                  | EXT   | 100  |

C = Current Measurement Output Available (IOUT).

P = Power Measurement Output Available (POUT).

Y = Yes.

N = No.

INT = Internal Resistor-Divider.

EXT = External Input Pin.

# High-Side Power and Current Monitors

**MAX4210/MAX4211**

## Ordering Information (continued)

| PART               | TEMP RANGE     | PIN-PACKAGE                    | TOP MARK |
|--------------------|----------------|--------------------------------|----------|
| MAX4210BETT        | -40°C to +85°C | 6 TDFN-6-EP*<br>(3mm x 3mm)    | AHG      |
| MAX4210BEUA        | -40°C to +85°C | 8 $\mu$ MAX                    | —        |
| MAX4210CETT        | -40°C to +85°C | 6 TDFN-6-EP*<br>(3mm x 3mm)    | AHH      |
| MAX4210CEUA        | -40°C to +85°C | 8 $\mu$ MAX                    | —        |
| MAX4210DETT        | -40°C to +85°C | 6 TDFN-6-EP*<br>(3mm x 3mm)    | AHI      |
| MAX4210DEUA        | -40°C to +85°C | 8 $\mu$ MAX                    | —        |
| MAX4210EETT        | -40°C to +85°C | 6 TDFN-6-EP*<br>(3mm x 3mm)    | AHJ      |
| MAX4210EEUA        | -40°C to +85°C | 8 $\mu$ MAX                    | —        |
| MAX4210FETT        | -40°C to +85°C | 6 TDFN-6-EP*<br>(3mm x 3mm)    | AHK      |
| MAX4210FEUA        | -40°C to +85°C | 8 $\mu$ MAX                    | —        |
| <b>MAX4211AETE</b> | -40°C to +85°C | 16 Thin QFN-EP*<br>(4mm x 4mm) | —        |
| MAX4211AEUE        | -40°C to +85°C | 16 TSSOP                       | —        |
| MAX4211BETE        | -40°C to +85°C | 16 Thin QFN-EP*<br>(4mm x 4mm) | —        |
| MAX4211BEUE        | -40°C to +85°C | 16 TSSOP                       | —        |
| MAX4211CETE        | -40°C to +85°C | 16 Thin QFN-EP*<br>(4mm x 4mm) | —        |
| MAX4211CEUE        | -40°C to +85°C | 16 TSSOP                       | —        |
| MAX4211DETE        | -40°C to +85°C | 16 Thin QFN-EP*<br>(4mm x 4mm) | —        |
| MAX4211DEUE        | -40°C to +85°C | 16 TSSOP                       | —        |
| MAX4211EETE        | -40°C to +85°C | 16 Thin QFN-EP*<br>(4mm x 4mm) | —        |
| MAX4211EEUE        | -40°C to +85°C | 16 TSSOP                       | —        |
| MAX4211FETE        | -40°C to +85°C | 16 Thin QFN-EP*<br>(4mm x 4mm) | —        |
| MAX4211FEUE        | -40°C to +85°C | 16 TSSOP                       | —        |

\*EP = Exposed paddle.

## Chip Information

MAX4210 TRANSISTOR COUNT: 515

MAX4211 TRANSISTOR COUNT: 1032

PROCESS: BiCMOS

# High-Side Power and Current Monitors

## Pin Configurations

TOP VIEW



**3mm x 3mm TDFN**

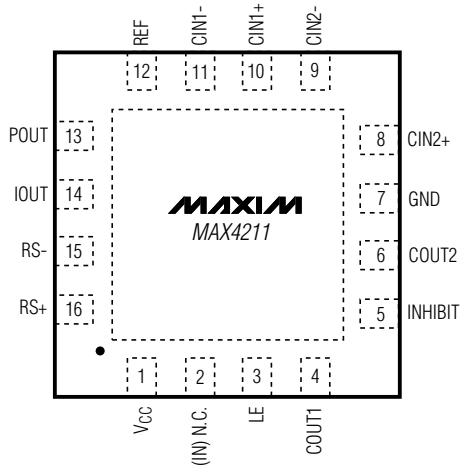

**4mm x 4mm THIN QFN**

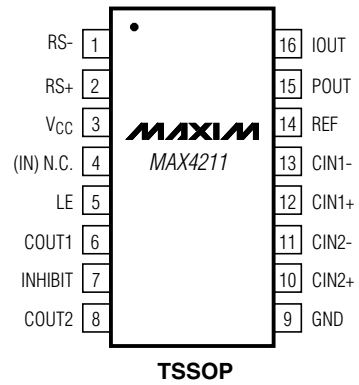

( ) ARE FOR MAX421\_D/E/F.

# High-Side Power and Current Monitors

## Package Information

(The package drawing(s) in this data sheet may not reflect the most current specifications. For the latest package outline information go to [www.maxim-ic.com/packages](http://www.maxim-ic.com/packages).)

MAX4210/MAX4211



| COMMON DIMENSIONS |           |      |  |  |  |  |  |  |
|-------------------|-----------|------|--|--|--|--|--|--|
| SYMBOL            | MIN.      | MAX. |  |  |  |  |  |  |
| A                 | 0.70      | 0.80 |  |  |  |  |  |  |
| D                 | 2.90      | 3.10 |  |  |  |  |  |  |
| E                 | 2.90      | 3.10 |  |  |  |  |  |  |
| A1                | 0.00      | 0.05 |  |  |  |  |  |  |
| L                 | 0.20      | 0.40 |  |  |  |  |  |  |
| k                 | 0.25 MIN. |      |  |  |  |  |  |  |
| A2                | 0.20 REF. |      |  |  |  |  |  |  |

| PACKAGE VARIATIONS |    |           |           |          |                |           |               |                   |
|--------------------|----|-----------|-----------|----------|----------------|-----------|---------------|-------------------|
| PKG. CODE          | N  | D2        | E2        | e        | JEDEC SPEC     | b         | [(N/2)-1] x e | DOWNBONDS ALLOWED |
| T633-1             | 6  | 1.50-0.10 | 2.30-0.10 | 0.95 BSC | MO229 / WEEA   | 0.40-0.05 | 1.90 REF      | NO                |
| T633-2             | 6  | 1.50-0.10 | 2.30-0.10 | 0.95 BSC | MO229 / WEEA   | 0.40-0.05 | 1.90 REF      | NO                |
| T833-1             | 8  | 1.50-0.10 | 2.30-0.10 | 0.65 BSC | MO229 / WEEC   | 0.30-0.05 | 1.95 REF      | NO                |
| T833-2             | 8  | 1.50-0.10 | 2.30-0.10 | 0.65 BSC | MO229 / WEEC   | 0.30-0.05 | 1.95 REF      | NO                |
| T833-3             | 8  | 1.50-0.10 | 2.30-0.10 | 0.65 BSC | MO229 / WEEC   | 0.30-0.05 | 1.95 REF      | YES               |
| T1033-1            | 10 | 1.50-0.10 | 2.30-0.10 | 0.50 BSC | MO229 / WEED-3 | 0.25-0.05 | 2.00 REF      | NO                |
| T1433-1            | 14 | 1.70-0.10 | 2.30-0.10 | 0.40 BSC | ----           | 0.20-0.05 | 2.40 REF      | YES               |
| T1433-2            | 14 | 1.70-0.10 | 2.30-0.10 | 0.40 BSC | ----           | 0.20-0.05 | 2.40 REF      | NO                |

NOTES:

1. ALL DIMENSIONS ARE IN mm, ANGLES IN DEGREES.
2. COPLANARITY SHALL NOT EXCEED 0.08 mm.
3. WARPAGE SHALL NOT EXCEED 0.10 mm.
4. PACKAGE LENGTH/PACKAGE WIDTH ARE CONSIDERED AS SPECIAL CHARACTERISTIC(S).
5. DRAWING CONFORMS TO JEDEC MO229, EXCEPT DIMENSIONS "D2" AND "E2", AND T1433-1 & T1433-2.
6. "N" IS THE TOTAL NUMBER OF LEADS.
7. NUMBER OF LEADS SHOWN ARE FOR REFERENCE ONLY.

-DRAWING NOT TO SCALE-

|  |                              |
|--|------------------------------|
| <b>DALLAS SEMICONDUCTOR</b>  | <b>MAXIM</b>                 |
| TITLE: PACKAGE OUTLINE, 6, 8, 10 & 14L, TDFN, EXPOSED PAD, 3x3x0.80 mm |                              |
| APPROVAL   | DOCUMENT CONTROL NO. 21-0137 |
| REV. G   | 2/2                          |

**NOTE:** THE TDFN EXPOSED PADDLE SIZE-VARIATION PACKAGE CODE: T633-1

# High-Side Power and Current Monitors

## Package Information (continued)

(The package drawing(s) in this data sheet may not reflect the most current specifications. For the latest package outline information go to [www.maxim-ic.com/packages](http://www.maxim-ic.com/packages).)



| COMMON DIMENSIONS |           |      |      |           |      |      |           |      |      |           |      |      |           |      |      |
|-------------------|-----------|------|------|-----------|------|------|-----------|------|------|-----------|------|------|-----------|------|------|
| PKG REF.          | 12L 4x4   |      |      | 16L 4x4   |      |      | 20L 4x4   |      |      | 24L 4x4   |      |      | 28L 4x4   |      |      |
|                   | MIN.      | NOM. | MAX. | MIN.      | NOM. | MAX. | MIN.      | NOM. | MAX. | MIN.      | NOM. | MAX. | MIN.      | NOM. | MAX. |
| A                 | 0.70      | 0.75 | 0.80 | 0.70      | 0.75 | 0.80 | 0.70      | 0.75 | 0.80 | 0.70      | 0.75 | 0.80 | 0.70      | 0.75 | 0.80 |
| A1                | 0.0       | 0.02 | 0.05 | 0.0       | 0.02 | 0.05 | 0.0       | 0.02 | 0.05 | 0.0       | 0.02 | 0.05 | 0.0       | 0.02 | 0.05 |
| A2                | 0.20 REF. |      |      | 0.20 REF. |      |      | 0.20 REF. |      |      | 0.20 REF. |      |      | 0.20 REF. |      |      |
| b                 | 0.25      | 0.30 | 0.35 | 0.25      | 0.30 | 0.35 | 0.20      | 0.25 | 0.30 | 0.18      | 0.23 | 0.30 | 0.15      | 0.20 | 0.25 |
| D                 | 3.90      | 4.00 | 4.10 | 3.90      | 4.00 | 4.10 | 3.90      | 4.00 | 4.10 | 3.90      | 4.00 | 4.10 | 3.90      | 4.00 | 4.10 |
| E                 | 3.90      | 4.00 | 4.10 | 3.90      | 4.00 | 4.10 | 3.90      | 4.00 | 4.10 | 3.90      | 4.00 | 4.10 | 3.90      | 4.00 | 4.10 |
| e                 | 0.80 BSC. |      |      | 0.65 BSC. |      |      | 0.50 BSC. |      |      | 0.50 BSC. |      |      | 0.40 BSC. |      |      |
| k                 | 0.25      | -    | -    | 0.25      | -    | -    | 0.25      | -    | -    | 0.25      | -    | -    | 0.25      | -    | -    |
| L                 | 0.45      | 0.55 | 0.65 | 0.45      | 0.55 | 0.65 | 0.45      | 0.55 | 0.65 | 0.30      | 0.40 | 0.50 | 0.30      | 0.40 | 0.50 |
| N                 | 12        |      |      | 16        |      |      | 20        |      |      | 24        |      |      | 28        |      |      |
| ND                | 3         |      |      | 4         |      |      | 5         |      |      | 6         |      |      | 7         |      |      |
| NE                | 3         |      |      | 4         |      |      | 5         |      |      | 6         |      |      | 7         |      |      |
| JEDEC Vpr         | VGG3      |      |      | VGGC      |      |      | WGGD-1    |      |      | WGGD-2    |      |      | VGGE      |      |      |

| EXPOSED PAD VARIATIONS |      |      |      |      |      |      |                    |  |  |  |  |  |
|------------------------|------|------|------|------|------|------|--------------------|--|--|--|--|--|
| PKG CODES              | D2   |      |      | E2   |      |      | DOWN BONDS ALLOWED |  |  |  |  |  |
|                        | MIN. | NOM. | MAX. | MIN. | NOM. | MAX. |                    |  |  |  |  |  |
| T1244-2                | 1.95 | 2.10 | 2.25 | 1.95 | 2.10 | 2.25 | NO                 |  |  |  |  |  |
| T1244-3                | 1.95 | 2.10 | 2.25 | 1.95 | 2.10 | 2.25 | YES                |  |  |  |  |  |
| T1244-4                | 1.95 | 2.10 | 2.25 | 1.95 | 2.10 | 2.25 | NO                 |  |  |  |  |  |
| T1644-2                | 1.95 | 2.10 | 2.25 | 1.95 | 2.10 | 2.25 | NO                 |  |  |  |  |  |
| T1644-3                | 1.95 | 2.10 | 2.25 | 1.95 | 2.10 | 2.25 | YES                |  |  |  |  |  |
| T1644-4                | 1.95 | 2.10 | 2.25 | 1.95 | 2.10 | 2.25 | NO                 |  |  |  |  |  |
| T2044-1                | 1.95 | 2.10 | 2.25 | 1.95 | 2.10 | 2.25 | NO                 |  |  |  |  |  |
| T2044-2                | 1.95 | 2.10 | 2.25 | 1.95 | 2.10 | 2.25 | YES                |  |  |  |  |  |
| T2044-3                | 1.95 | 2.10 | 2.25 | 1.95 | 2.10 | 2.25 | NO                 |  |  |  |  |  |
| T2444-1                | 2.45 | 2.60 | 2.63 | 2.45 | 2.60 | 2.63 | NO                 |  |  |  |  |  |
| T2444-2                | 1.95 | 2.10 | 2.25 | 1.95 | 2.10 | 2.25 | YES                |  |  |  |  |  |
| T2444-3                | 2.45 | 2.60 | 2.63 | 2.45 | 2.60 | 2.63 | YES                |  |  |  |  |  |
| T2444-4                | 2.45 | 2.60 | 2.63 | 2.45 | 2.60 | 2.63 | NO                 |  |  |  |  |  |
| T2844-1                | 2.50 | 2.60 | 2.70 | 2.50 | 2.60 | 2.70 | NO                 |  |  |  |  |  |

NOTES:

- DIMENSIONING & TOLERANCING CONFORM TO ASME Y14.5M-1994.
- ALL DIMENSIONS ARE IN MILLIMETERS. ANGLES ARE IN DEGREES.
- N IS THE TOTAL NUMBER OF TERMINALS.
- THE TERMINAL #1 IDENTIFIER AND TERMINAL NUMBERING CONVENTION SHALL CONFORM TO JEDEC 95-1 SPP-012. DETAILS OF TERMINAL #1 IDENTIFIER ARE OPTIONAL, BUT MUST BE LOCATED WITHIN THE ZONE INDICATED. THE TERMINAL #1 IDENTIFIER MAY BE EITHER A MOLD OR MARKED FEATURE.
- DIMENSION b APPLIES TO METALLIZED TERMINAL AND IS MEASURED BETWEEN 0.25 mm AND 0.30 mm FROM TERMINAL TIP.
- ND AND NE REFER TO THE NUMBER OF TERMINALS ON EACH D AND E SIDE RESPECTIVELY.
- DEPOPULATION IS POSSIBLE IN A SYMMETRICAL FASHION.
- COPLANARITY APPLIES TO THE EXPOSED HEAT SINK SLUG AS WELL AS THE TERMINALS.
- DRAWING CONFORMS TO JEDEC M0220, EXCEPT FOR T2444-1, T2444-3, T2444-4 AND T2844-1.
- MARKING IS FOR PACKAGE ORIENTATION REFERENCE ONLY.
- COPLANARITY SHALL NOT EXCEED 0.08mm
- WARPAGE SHALL NOT EXCEED 0.10mm
- LEAD CENTERLINES TO BE AT TRUE POSITION AS DEFINED BY BASIC DIMENSION "e", ±0.05.

-DRAWING NOT TO SCALE-

|   |                      |       |     |
|---|----------------------|-------|-----|
| DALLAS SEMICONDUCTOR                    |                      | MAXIM |     |
| TITLE PACKAGE OUTLINE                   |                      |       |     |
| 12, 16, 20, 24, 28L THIN QFN, 4x4x0.8mm |                      |       |     |
| APPROVAL                                | DOCUMENT CONTROL NO. | REV.  | 2/2 |
|   | 21-0139              | D     |     |

NOTE: THE THIN QFN EXPOSED PADDLE SIZE-VARIATION PACKAGE CODE: T1644-4

# High-Side Power and Current Monitors

## Package Information (continued)

(The package drawing(s) in this data sheet may not reflect the most current specifications. For the latest package outline information go to [www.maxim-ic.com/packages](http://www.maxim-ic.com/packages).)

MAX4210/MAX4211



# High-Side Power and Current Monitors

## Package Information (continued)

(The package drawing(s) in this data sheet may not reflect the most current specifications. For the latest package outline information go to [www.maxim-ic.com/packages](http://www.maxim-ic.com/packages).)



TSSOP4.40mm.EPS

- NOTES:
1. DIMENSIONS D AND E DO NOT INCLUDE FLASH
  2. MOLD FLASH OR PROTRUSIONS NOT TO EXCEED 0.15mm PER SIDE
  3. CONTROLLING DIMENSION: MILLIMETER
  4. MEETS JEDEC OUTLINE MO-153. SEE JEDEC VARIATIONS TABLE
  5. 'N' REFERS TO NUMBER OF LEADS

Maxim cannot assume responsibility for use of any circuitry other than circuitry entirely embodied in a Maxim product. No circuit patent licenses are implied. Maxim reserves the right to change the circuitry and specifications without notice at any time.

32 \_\_\_\_\_ Maxim Integrated Products, 120 San Gabriel Drive, Sunnyvale, CA 94086 408-737-7600



Компания «Океан Электроники» предлагает заключение долгосрочных отношений при поставках импортных электронных компонентов на взаимовыгодных условиях!

Наши преимущества:

- Поставка оригинальных импортных электронных компонентов напрямую с производств Америки, Европы и Азии, а так же с крупнейших складов мира;
- Широкая линейка поставок активных и пассивных импортных электронных компонентов (более 30 млн. наименований);
- Поставка сложных, дефицитных, либо снятых с производства позиций;
- Оперативные сроки поставки под заказ (от 5 рабочих дней);
- Экспресс доставка в любую точку России;
- Помощь Конструкторского Отдела и консультации квалифицированных инженеров;
- Техническая поддержка проекта, помощь в подборе аналогов, поставка прототипов;
- Поставка электронных компонентов под контролем ВП;
- Система менеджмента качества сертифицирована по Международному стандарту ISO 9001;
- При необходимости вся продукция военного и аэрокосмического назначения проходит испытания и сертификацию в лаборатории (по согласованию с заказчиком);
- Поставка специализированных компонентов военного и аэрокосмического уровня качества (Xilinx, Altera, Analog Devices, Intersil, Interpoint, Microsemi, Actel, Aeroflex, Peregrine, VPT, Syfer, Eurofarad, Texas Instruments, MS Kennedy, Miteq, Cobham, E2V, MA-COM, Hittite, Mini-Circuits, General Dynamics и др.);

Компания «Океан Электроники» является официальным дистрибьютором и эксклюзивным представителем в России одного из крупнейших производителей разъемов военного и аэрокосмического назначения «JONHON», а так же официальным дистрибьютором и эксклюзивным представителем в России производителя высокотехнологичных и надежных решений для передачи СВЧ сигналов «FORSTAR».



## JONHON

«JONHON» (основан в 1970 г.)

Разъемы специального, военного и аэрокосмического назначения:

(Применяются в военной, авиационной, аэрокосмической, морской, железнодорожной, горно- и нефтедобывающей отраслях промышленности)

«FORSTAR» (основан в 1998 г.)

ВЧ соединители, коаксиальные кабели, кабельные сборки и микроволновые компоненты:

(Применяются в телекоммуникациях гражданского и специального назначения, в средствах связи, РЛС, а так же военной, авиационной и аэрокосмической отраслях промышленности).



Телефон: 8 (812) 309-75-97 (многоканальный)

Факс: 8 (812) 320-03-32

Электронная почта: [ocean@oceanchips.ru](mailto:ocean@oceanchips.ru)

Web: <http://oceanchips.ru/>

Адрес: 198099, г. Санкт-Петербург, ул. Калинина, д. 2, корп. 4, лит. А