



FEATURES

- Qualified for automotive applications
- Output overvoltage (short-to-battery) protection up to 18 V
- Short-to-battery output flag for wire diagnostics
- Output short-to-ground protection
- Fifth-order, low-pass video filter
 - 0.1 dB flatness to 3 MHz
 - 3 dB bandwidth of 10 MHz
 - 45 dB rejection at 27 MHz
- Ultralow power-down current: 13.5 μ A typical
- Low quiescent current: 13.2 mA typical
- Low supply voltage: 2.7 V to 3.6 V
- Small package: 3 mm \times 3 mm LFCSP
- Wide operating temperature range: -40°C to +125°C

APPLICATIONS

- Automotive rearview cameras
- Automotive video electronic control units (ECUs)
- Surveillance video systems

GENERAL DESCRIPTION

The [ADA4433-1](#) (differential output) is a fully integrated video reconstruction filter that combines overvoltage protection (short-to-battery [STB] protection) and short-to-ground (STG) protection on the outputs with excellent video specifications and low power consumption. The combination of STB protection and robust ESD tolerance allows the [ADA4433-1](#) to provide superior protection in the hostile automotive environment.

The [ADA4433-1](#) is a fully differential video filter that can be used as a fully differential input to a differential output or as a single-ended input to a differential output, allowing it to easily connect to both differential and single-ended sources. It is capable of driving twisted pair or coaxial cable with minimal line attenuation. Differential signal processing reduces the effects of ground noise, which can plague ground referenced systems. The [ADA4433-1](#) is ideal for differential signal processing (gain and filtering) throughout the signal chain, simplifying the conversion between single-ended and differential components.

FUNCTIONAL BLOCK DIAGRAM



Figure 1.

10097-002

The short-to-battery protection integrated into the [ADA4433-1](#) protects against both dc and transient overvoltage events caused by accidental shorts to the battery voltage up to 18 V. The Analog Devices, Inc., short-to-battery protection eliminates the need for large output coupling capacitors and other complicated circuits used to protect standard video amplifiers, saving space and cost.

The [ADA4433-1](#) features a high-order filter with -3 dB cutoff frequency response at 10 MHz and 45 dB of rejection at 27 MHz. The [ADA4433-1](#) features an internally fixed gain of 2 V/V. This makes the [ADA4433-1](#) ideal for SD video applications, including NTSC and PAL.

The [ADA4433-1](#) operates on a single supply as low as 2.7 V and as high as 3.6 V while providing the dynamic range required by the most demanding video systems.

The [ADA4433-1](#) is offered in an 8-lead, 3 mm \times 3 mm LFCSP package and is rated for operation over the wide automotive temperature range of -40°C to +125°C.

Rev. 0

Information furnished by Analog Devices is believed to be accurate and reliable. However, no responsibility is assumed by Analog Devices for its use, nor for any infringements of patents or other rights of third parties that may result from its use. Specifications subject to change without notice. No license is granted by implication or otherwise under any patent or patent rights of Analog Devices. Trademarks and registered trademarks are the property of their respective owners.

TABLE OF CONTENTS

Features	1	Short-to-Battery Output Flag	10
Applications.....	1	ESD Protection	11
Functional Block Diagram	1	Enable/Disable Modes (ENA Pin)	11
General Description	1	Operating Supply Voltage Range.....	11
Revision History	2	Applications Information	12
Specifications.....	3	Fully Differential Transmission Mode.....	12
Absolute Maximum Ratings.....	5	Printed Circuit Board (PCB) Layout	12
Thermal Resistance	5	Configuring the ADA4433-1 for Single-Ended Input Signals...	13
Maximum Power Dissipation	5	Typical Application Circuit.....	14
ESD Caution.....	5	Fully DC-Coupled Transmission Line	15
Pin Configuration and Function Descriptions.....	6	Outline Dimensions	16
Typical Performance Characteristics	7	Ordering Guide	16
Theory of Operation	10	Automotive Products.....	16
Short Circuit (Short-to-Ground) Protection.....	10		
Overvoltage (Short-to-Battery) Protection.....	10		

REVISION HISTORY

4/12—Revision 0: Initial Version

SPECIFICATIONS

$T_A = 25^\circ\text{C}$, $+V_S = 3.3\text{ V}$, $V_{-IN} = 0.5\text{ V}$, $R_L = 150\ \Omega$, unless otherwise specified.

Table 1.

Parameter	Test Conditions/Comments	Min	Typ	Max	Unit
DYNAMIC PERFORMANCE					
–3 dB Small Signal Bandwidth	$V_O = 0.2\text{ V p-p}$		9.9		MHz
–3 dB Large Signal Bandwidth	$V_O = 2\text{ V p-p}$	8.8	9.9		MHz
	ADA4433-1W only: T_{MIN} to T_{MAX}	8.2			MHz
1 dB Flatness	$V_O = 2\text{ V p-p}$	7.7	8.7		MHz
	ADA4433-1W only: T_{MIN} to T_{MAX}	7.2			MHz
0.1 dB Flatness	$V_O = 2\text{ V p-p}$		3		MHz
Out-of-Band Rejection	$f = 27\text{ MHz}$	41	45		dB
	ADA4433-1W only: T_{MIN} to T_{MAX}	39			dB
Differential Gain	Modulated 10-step ramp, sync tip at 0 V		0.5		%
Differential Phase	Modulated 10-step ramp, sync tip at 0 V		1.7		Degrees
Group Delay Variation	$f = 100\text{ kHz to }5\text{ MHz}$		8		ns
Pass Band Gain		5.89	6	6.15	dB
	ADA4433-1W only: T_{MIN} to T_{MAX}	5.71		6.28	dB
NOISE/HARMONIC PERFORMANCE					
Signal-to-Noise Ratio	100% white signal, $f = 100\text{ kHz to }5\text{ MHz}$		67		dB
INPUT CHARACTERISTICS					
Input Common-Mode Voltage Range		0 to 2.1	0 to 2.2	0 to 2.3	V
	ADA4433-1W only: T_{MIN} to T_{MAX}	0 to 2.0		0 to 2.5	V
Input Resistance	Differential		800		k Ω
	Common-mode		400		k Ω
Input Capacitance	Common-mode		1.8		pF
Input Bias Current			30		pA
CMRR	$V_{-IN} = V_{+IN} = 0.1\text{ V to }1.1\text{ V}$		–55		dB
OUTPUT CHARACTERISTICS					
Output Offset Voltage	$V_{+IN} = V_{-IN} = 0\text{ V}$		1.65	1.9	V
	ADA4433-1W only: T_{MIN} to T_{MAX}			1.9	V
Output Voltage Swing	Each single-ended output, $R_{L, dm} = 150\ \Omega$	0.54		$+V_S - 0.55$	V
	ADA4433-1W only: T_{MIN} to T_{MAX}	0.6		$+V_S - 0.6$	V
Linear Output Current			± 29		mA
Short-Circuit Output Current			± 60		mA
Output Balance Error	DC to $f = 100\text{ kHz}$, $V_{IN} = 0.5\text{ V p-p}$		–50		dB
SHORT TO BATTERY					
Overvoltage Protection Range		$+V_S$		18	V
	ADA4433-1W only: T_{MIN} to T_{MAX}			18	V
STB Output Trigger Threshold	Each output back termination = 37.5 Ω	5.0	5.4	5.7	V
	ADA4433-1W only: T_{MIN} to T_{MAX}	4.9		6.0	V
Disconnect Time	After the fault is applied		150		ns
Reconnect Time	After the fault is removed		300		ns
POWER SUPPLY					
Power Supply Range ¹	Maximum variation outside this range $\leq 4\%$	2.7		3.6	V
Quiescent Current	No input signal, no load		13.2	18	mA
	ADA4433-1W only: T_{MIN} to T_{MAX}			19	mA
Quiescent Current, Disabled	ENA = 0 V		13.5	22	μA
	ADA4433-1W only: T_{MIN} to T_{MAX}			30	μA
Quiescent Current, Short-to-Battery	Short-to-battery fault condition: 18 V		18		mA
PSRR	$\Delta +V_S \text{ RIPPLE} = \pm 0.3\text{ V}$		–57		dB

Parameter	Test Conditions/Comments	Min	Typ	Max	Unit
ENABLE PIN Input Leakage Current	ENA = high/low		+0.3/-14		μA
LOGIC OUTPUT/INPUT LEVELS					
STB V _{OH}	V _{OUT} ≥ 5.7 V (fault condition)		3.3		V
STB V _{OL}	V _{OUT} ≤ 5 V (normal operation)		0.02		V
ENA V _{IH}	Input voltage to enable device		≥2.4		V
ENA V _{IL}	Input voltage to disable device		≤0.6		V
OPERATING TEMPERATURE RANGE		-40		+125	°C

¹ See the Operating Supply Voltage Range section for a detailed explanation.

ABSOLUTE MAXIMUM RATINGS

Table 2.

Parameter	Rating
Supply Voltage	4 V
Output Common-Mode Voltage	22 V
Input Differential Voltage	+V _S
Power Dissipation	See Figure 2
Storage Temperature Range	-65°C to +125°C
Operating Temperature Range	-40°C to +125°C
Lead Temperature (Soldering, 10 sec)	260°C
Junction Temperature	150°C

Stresses above those listed under Absolute Maximum Ratings may cause permanent damage to the device. This is a stress rating only; functional operation of the device at these or any other conditions above those indicated in the operational section of this specification is not implied. Exposure to absolute maximum rating conditions for extended periods may affect device reliability.

THERMAL RESISTANCE

θ_{JA} is specified for the device soldered to a high thermal conductivity 4-layer (2s2p) circuit board, as described in EIA/JESD 51-7.

Table 3.

Package Type	θ_{JA}	θ_{JC}	Unit
8-Lead LFCSP	50	5	°C/W

MAXIMUM POWER DISSIPATION

The maximum safe power dissipation in the ADA4433-1 package is limited by the associated rise in junction temperature (T_J) on the die. At approximately 150°C, which is the glass transition temperature, the plastic changes its properties. Exceeding a junction temperature of 150°C for an extended time can result in changes in the silicon devices, potentially causing failure.

The power dissipated in the package (P_D) is the sum of the quiescent power dissipation and the power dissipated in the package due to the load drive for all outputs. The quiescent power is the voltage between the supply pins (V_S) times the quiescent current (I_S). The power dissipated due to the load drive depends on the particular application. For each output, the power due to load drive is calculated by multiplying the load current by the associated voltage drop across the device. The power dissipated due to the loads is equal to the sum of the power dissipations due to each individual load. RMS voltages and currents must be used in these calculations.

Airflow increases heat dissipation, effectively reducing θ_{JA} . Figure 2 shows the maximum power dissipation in the package vs. the ambient temperature for the 8-lead LFCSP (50°C/W) on a JEDEC standard 4-layer board. θ_{JA} values are approximate.

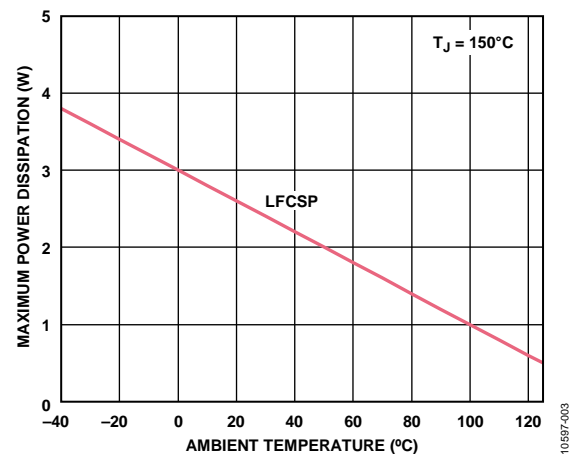

Figure 2. Maximum Power Dissipation vs. Ambient Temperature for a 4-Layer Board

ESD CAUTION



ESD (electrostatic discharge) sensitive device. Charged devices and circuit boards can discharge without detection. Although this product features patented or proprietary protection circuitry, damage may occur on devices subjected to high energy ESD. Therefore, proper ESD precautions should be taken to avoid performance degradation or loss of functionality.

PIN CONFIGURATION AND FUNCTION DESCRIPTIONS

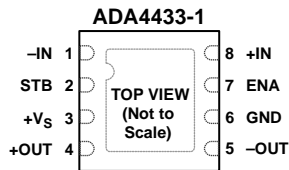

NOTES
 1. THE EXPOSED PAD CAN BE CONNECTED TO THE GROUND PLANE.

10697-006

Figure 3. Pin Configuration, Top View

Table 4. Pin Function Descriptions

Pin No.	Mnemonic	Description
1	-IN	Inverting Input.
2	STB	Short-to-Battery Indicator Output. A logic high indicates a short-to-battery condition, and a logic low indicates normal operation.
3	+Vs	Positive Power Supply. Bypass with a 0.1 μ F capacitor to GND.
4	+OUT	Noninverting Output.
5	-OUT	Inverting Output.
6	GND	Ground.
7	ENA	Enable Function. Connect to +Vs or float for normal operation; connect to GND for device disable.
8	+IN	Noninverting Input.
	EPAD	The exposed pad can be connected to the ground plane.

TYPICAL PERFORMANCE CHARACTERISTICS

$T_A = 25^\circ\text{C}$, $+V_S = 3.3\text{ V}$, $V_{-IN} = 0.5\text{ V}$, $R_L = 150\ \Omega$, unless otherwise specified.

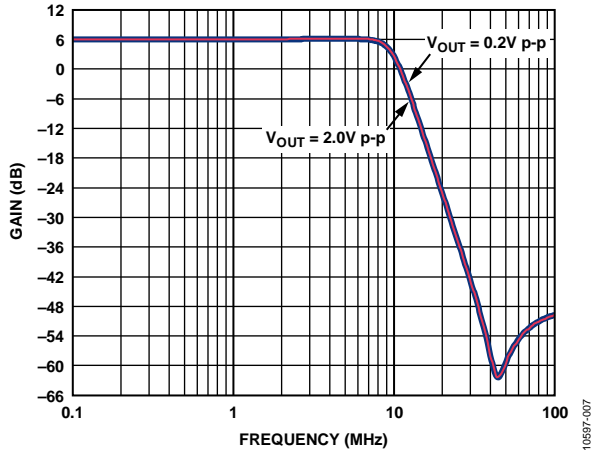

Figure 4. Frequency Response at Various Output Amplitudes

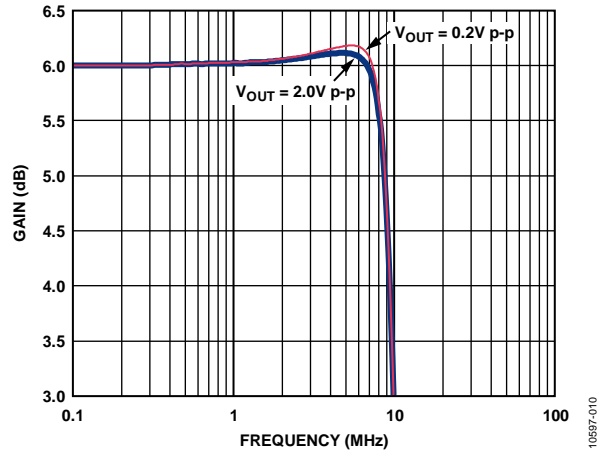

Figure 7. 1 dB Flatness Response at Various Output Amplitudes

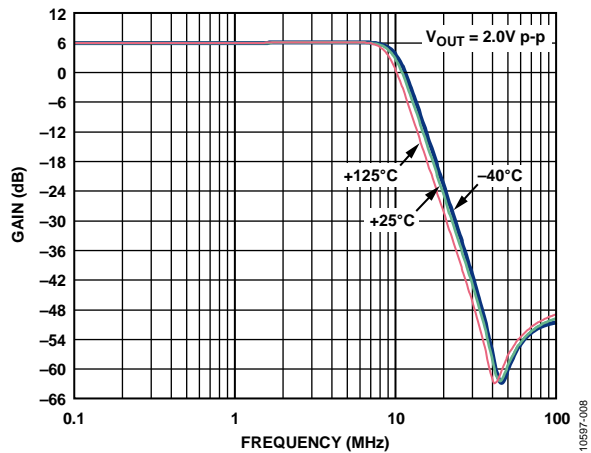

Figure 5. Large Signal Frequency Response at Various Temperatures

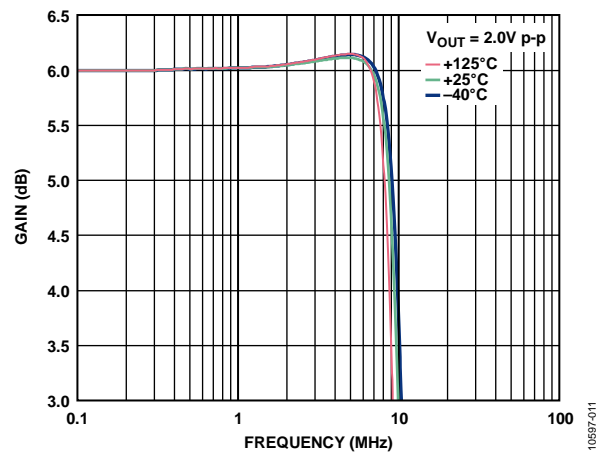

Figure 8. 1 dB Flatness Response at Various Temperatures

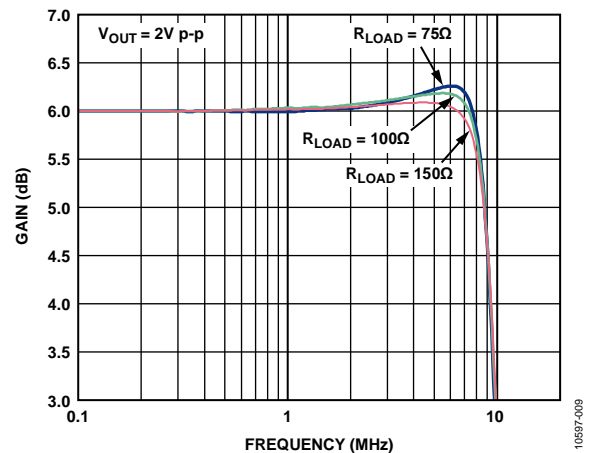

Figure 6. 1 dB Flatness Response at Various Load Resistances

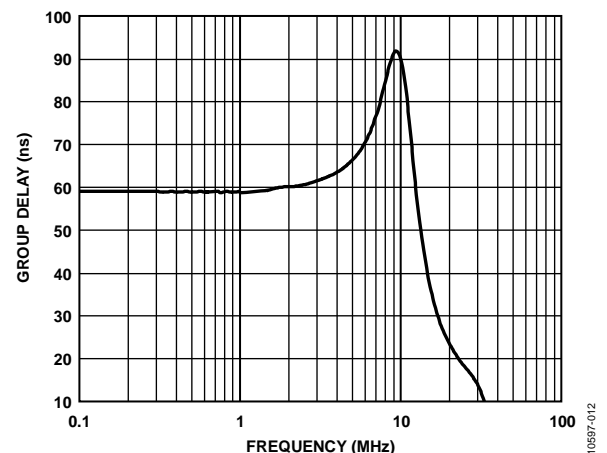

Figure 9. Group Delay vs. Frequency



Figure 10. Differential Gain Plot

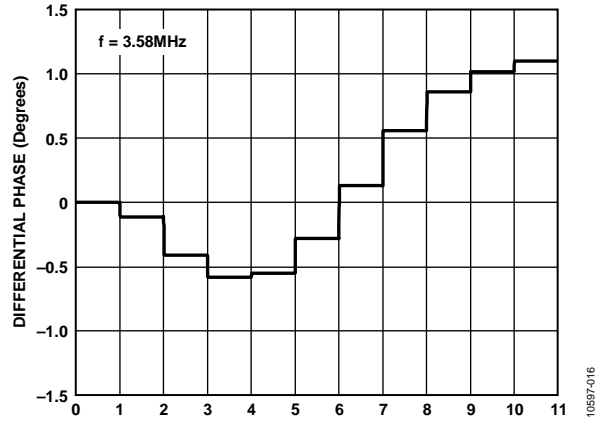

Figure 13. Differential Phase Plot

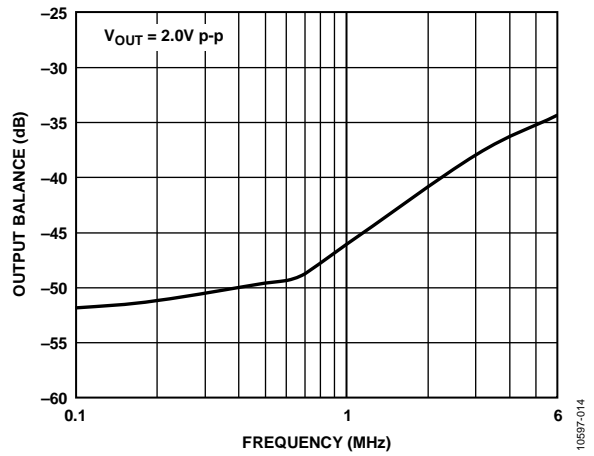

Figure 11. Output Balance Error vs. Frequency

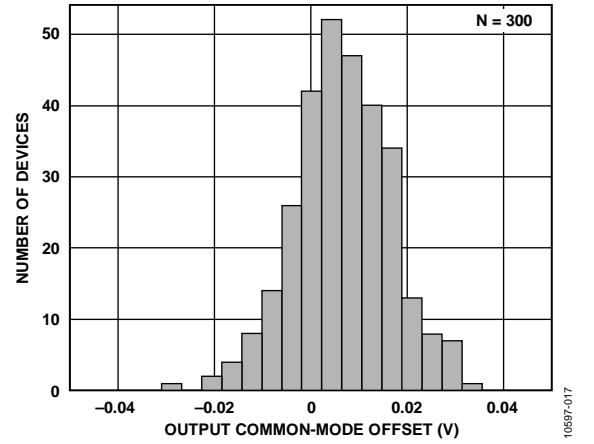

Figure 14. Output Common-Mode Offset Voltage

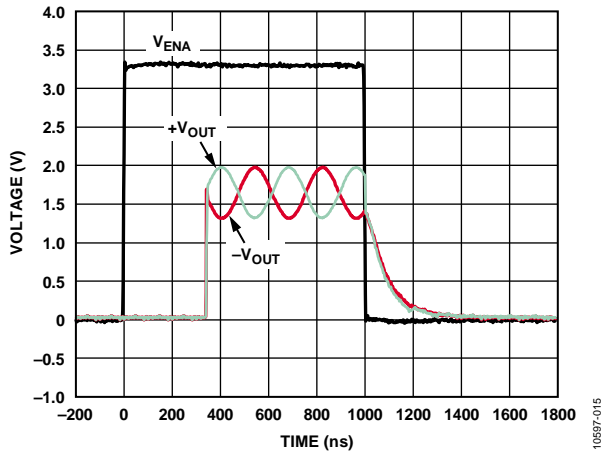

Figure 12. Enable (ENA)/Disable Time

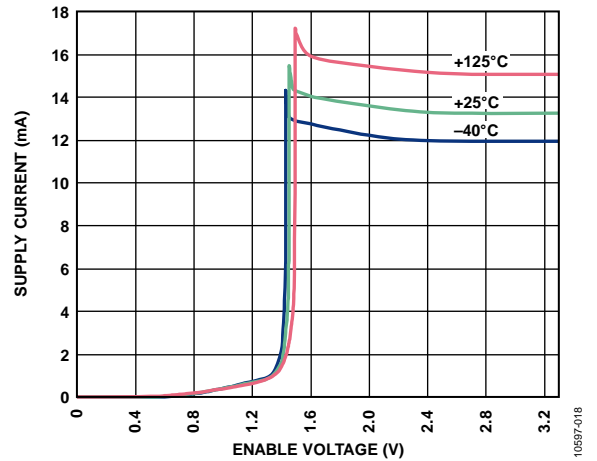

Figure 15. Supply Current vs. Enable Voltage at Various Temperatures

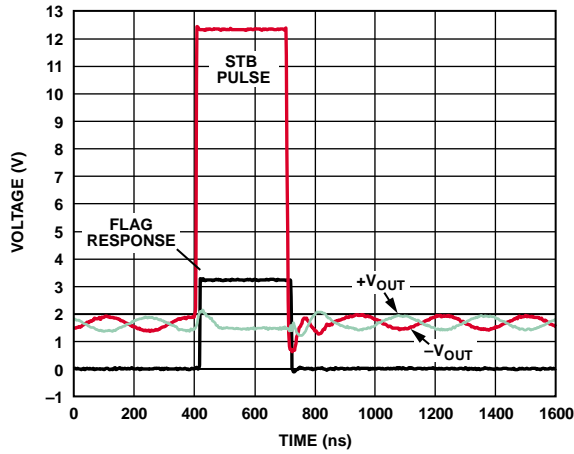

Figure 16. STB Output Flag Response Time



Figure 19. STB Output Response vs. Short-to-Battery Voltage on Outputs

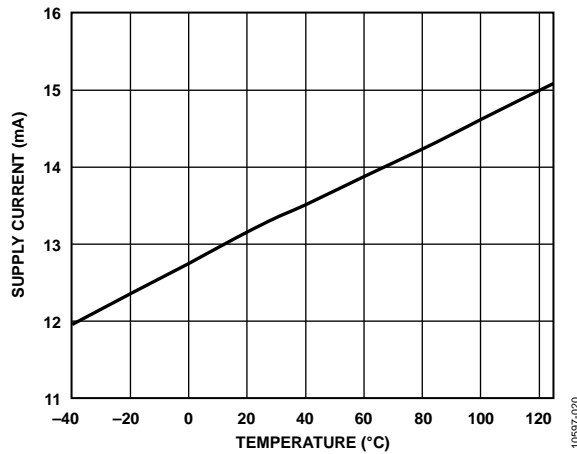

Figure 17. Supply Current vs. Temperature

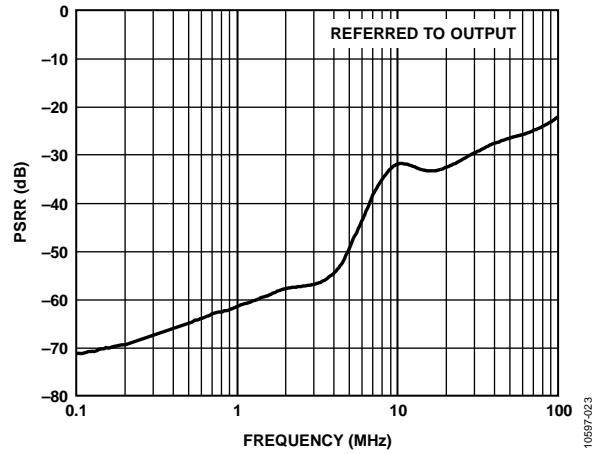

Figure 20. Power Supply Rejection Ratio (PSRR) vs. Frequency



Figure 18. Output Transient Response

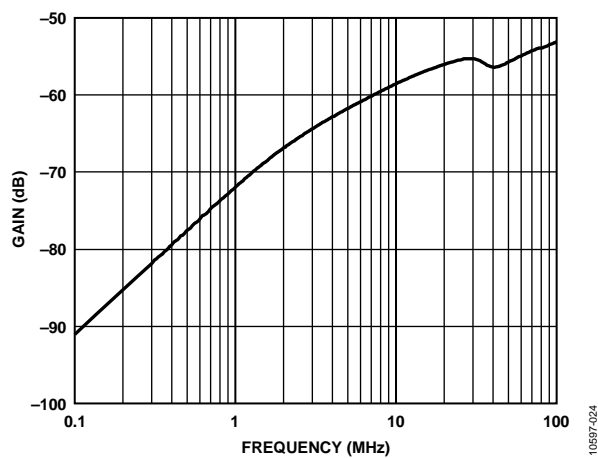

Figure 21. Input-to-Output Off (Disabled) Isolation vs. Frequency

THEORY OF OPERATION

The ADA4433-1 with short-to-battery and short-to-ground protection is designed as a fifth-order, low-pass filter with a fixed gain of 2 that is capable of driving 2 V p-p video signals into doubly terminated video transmission lines on a single supply as low as 2.7 V. The filter has a 1 dB flatness of 9 MHz and provides a typical out-of-band rejection of 45 dB at 27 MHz.

The ADA4433-1 is a fully differential filter/driver that is also designed for compliance with both ac- and dc-coupled inputs and outputs. The ADA4433-1 can be driven by a differential or single-ended source and provides a fully differential output signal that is biased at a voltage equal to half the supply voltage (+V_S/2). When the device is used with a single-ended input source, bias the inverting input, -IN, at the middle of the input voltage range applied to the noninverting input, +IN, allowing each output signal to swing equally around the midsupply point (see the Configuring the ADA4433-1 for Single-Ended Input Signals section). This is particularly important to maximize output voltage headroom in low supply voltage applications.

SHORT CIRCUIT (SHORT-TO-GROUND) PROTECTION

The ADA4433-1 includes an internal protection circuit that limits the output sink or source current to 60 mA. This short-circuit protection prevents damage to the ADA4433-1 when the output(s) are shorted to ground, to a low impedance source, or together for an extended time. In addition, the total sink or source current for both outputs is limited to 50 mA, which helps protect the device in the event of both outputs being shorted to a low impedance. However, the short circuit protection does not affect the normal operation of the device because one output sources current while the other output sinks current when driving a differential output signal.

OVERVOLTAGE (SHORT-TO-BATTERY) PROTECTION

The ADA4433-1 includes an internal protection circuit to ensure that internal circuitry is not subjected to extreme voltages or currents during an overvoltage event applied to its outputs. A short-to-battery condition usually consists of a voltage on the outputs that is significantly higher than the power supply voltage of the amplifier. Duration can vary from a short transient to a continuous fault.

The ADA4433-1 can withstand voltages of up to 18 V on its outputs. Critical internal nodes are protected from exposure to high voltages by circuitry that isolates the output devices from the high voltage and limits internal currents. This protection is available whether the device is enabled or disabled, even when the supply voltage is removed.

The output devices are disconnected when the voltage at the output pins exceeds the supply voltage. After the overvoltage condition is removed, internal circuitry pulls the output voltage back within normal operating levels. The output devices are reconnected when the voltage at the output pins falls below the supply voltage by about 300 mV. When the ADA4433-1 is used with a doubly terminated cable, the voltage sensed at the output pins is lower than the voltage applied to the cable by the voltage drop across the back termination resistor. The maximum voltage drop across the back termination resistor is limited by the short-circuit current protection; therefore, the threshold at which the overvoltage protection responds to a voltage applied to the cable is

$$V_{THRESH(CABLE)} = +V_S + I_{LIMIT}R_T$$

where:

$V_{THRESH(CABLE)}$ is the voltage applied to the cable that activates the internal isolation circuitry.

+V_S is the positive supply voltage.

I_{LIMIT} is the internal short-circuit current limit, typically 50 mA.
R_T the back termination resistance.

If the voltage applied to the cable is lower than $V_{THRESH(CABLE)}$, the voltage seen at the output pins is lower than the supply voltage, so no overvoltage condition is detected. However, the internal circuitry is protected by the short-circuit current limit; therefore, the ADA4433-1 can withstand an indefinite duration short to any positive voltage up to 18 V without damage.

SHORT-TO-BATTERY OUTPUT FLAG

In addition to the internal protection circuitry, the short-to-battery output flag (STB pin) indicates an overvoltage condition on either or both output pins. The flag is present whenever the internal overvoltage protection is active; therefore, it is available when the device is enabled or disabled. It is not available, however, when the supply voltage is removed, although the internal protection is still active. The threshold at which the short-to-battery flag is activated and deactivated is the same as the threshold for the protection circuitry.

Table 5. STB Pin Logic

STB Pin Output	Device State
High (Logic 1)	Overvoltage fault condition
Low (Logic 0)	Normal operation

ESD PROTECTION

All pins on the [ADA4433-1](#) are protected with internal ESD protection structures connected to the power supply pins (+V_s and GND). These structures provide protection during the handling and manufacturing process.

The outputs (+OUT and –OUT) can be exposed to dc voltages well above the supply voltage in an overvoltage event; therefore, conventional ESD structure protection cannot be used. Instead, the outputs are protected by Analog Devices proprietary ESD devices, which allow protection and recovery from an overvoltage event while providing ESD protection well beyond the handling and manufacturing requirements.

ENABLE/DISABLE MODES (ENA PIN)

The power-down or enable/disable (ENA) pin is internally pulled up to +V_s through a 250 k Ω resistor. When the voltage on this pin is high, the amplifier is enabled; pulling ENA low disables the [ADA4433-1](#), reducing the supply current to a very low 13.5 μ A. With no external connection, this pin floats high, enabling the amplifier.

Table 6. ENA Pin Function

ENA Pin Input	Device State
High (Logic 1)	Enabled
Low (Logic 0)	Disabled
High-Z (Floating)	Enabled

OPERATING SUPPLY VOLTAGE RANGE

The [ADA4433-1](#) is specified over an operating supply voltage range of 2.7 V to 3.6 V. This range establishes the nominal utilization voltage at which the device performs in conformance with its specifications. The operating supply voltage refers to sustained voltage levels and not to a momentary voltage excursion that can occur due to variation in the output of the supply regulator. When the device is operating at the limits of the operating supply voltage range (2.7 V and 3.6 V), excursions lower than the minimum of 2.7 V and higher the maximum of 3.6 V must be no greater than 4%. Supply voltage excursions greater than 4% (but less than the absolute maximum) can lead to some performance degradation; however, they do not damage the device.

APPLICATIONS INFORMATION

FULLY DIFFERENTIAL TRANSMISSION MODE

The ADA4433-1 is designed to be used as a fully differential driver. The differential outputs of the ADA4433-1 allow fully balanced transmission using twisted or untwisted pair cable. In this configuration, the differential output termination consists of two source resistors, one on each output, each equal to half the receiver input termination. For example, in a 75 Ω system, each output of the ADA4433-1 is back terminated with 37.5 Ω resistors that are connected to a differential resistance of 75 Ω at the receiver (see Figure 22).

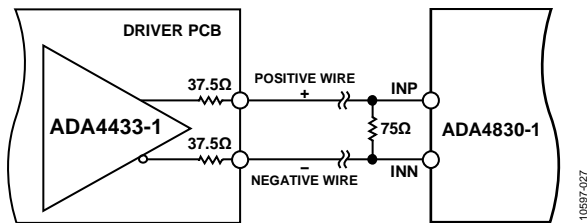

Figure 22. Fully Differential Mode

PRINTED CIRCUIT BOARD (PCB) LAYOUT

As with all high speed applications, attention to PCB layout is of paramount importance. Adhere to standard high speed layout practices when designing with the ADA4433-1. A solid ground plane is recommended. Place a 0.1 μ F surface-mount, ceramic power supply decoupling capacitor as close as possible to the supply pin.

Connect the GND pin to the ground plane with a trace that is as short as possible. Use controlled impedance traces of the shortest length possible to connect to the signal I/O pins and do not run the traces over any voids in the ground plane. A 75 Ω impedance level is typically used in video applications. All signal outputs of the ADA4433-1 should include series termination resistors when driving transmission lines.

When the ADA4433-1 receives its inputs from a device with current outputs, the required load resistor value for the output current is most often different from the characteristic impedance of the signal traces. In this case, if the interconnections are sufficiently short (less than 2 inches), the trace does not need to be terminated in its characteristic impedance.

CONFIGURING THE ADA4433-1 FOR SINGLE-ENDED INPUT SIGNALS

The ADA4433-1 is a fully differential filter/driver that can be used as a single-ended-to-differential amplifier or as a differential-to-differential amplifier. In single-ended-to-differential output applications, bias the -IN input appropriately to optimize the output range. To make the most efficient use of the output range of the ADA4433-1, especially with low supply voltages, it is important to allow the differential output voltage to swing in both a positive and negative direction around the output common-mode voltage (V_{OCM}) level, the midsupply point. To do this, the differential input voltage must swing both positive and negative. Figure 23 shows a 1 V p-p single-ended signal on +IN with -IN grounded. This produces a differential input voltage that ranges from 0 V to 1 V. The resulting differential output voltage is

strictly positive, where each output swings only above V_{+OUT} or below V_{-OUT} , the midsupply V_{OCM} level. Directly at the output of the ADA4433-1, the output voltage extends from 0.65 V to 2.65 V, requiring a full 2 V of output to produce a 1 V p-p signal at the receiver (represented by the voltage across 2R).

To make a more efficient use of the output range, the -IN input is biased at the midpoint of the expected input signal range, as shown in Figure 24. A 1 V p-p single-ended signal on +IN, with -IN biased at 0.5 V, produces a differential input voltage that ranges from -0.5 V to +0.5 V. The resulting differential output voltage now contains both positive and negative components, where each output swings both above and below the midsupply V_{OCM} level. Directly at the output of the ADA4433-1, the output voltage now extends only from 1.15 V to 2.15 V, requiring only 1 V of the output to produce a 1 V p-p signal at the receiver.

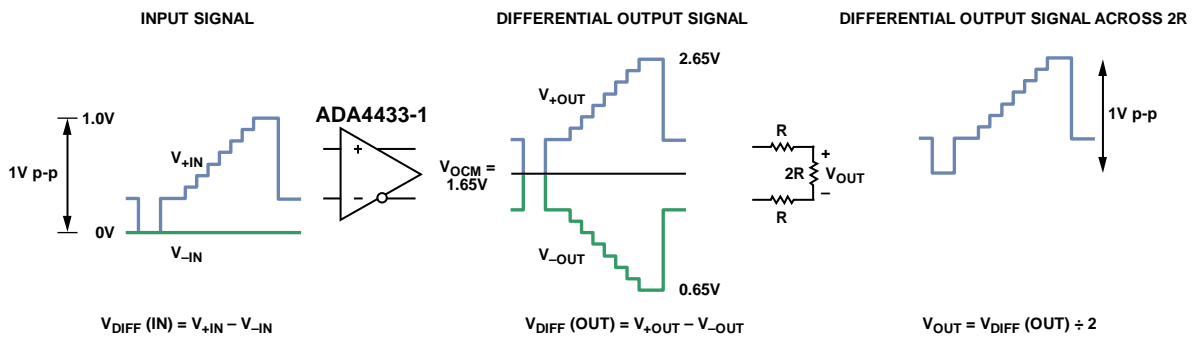

Figure 23. Single-Ended-to-Differential Configuration with Negative Input (-IN) Connected to Ground

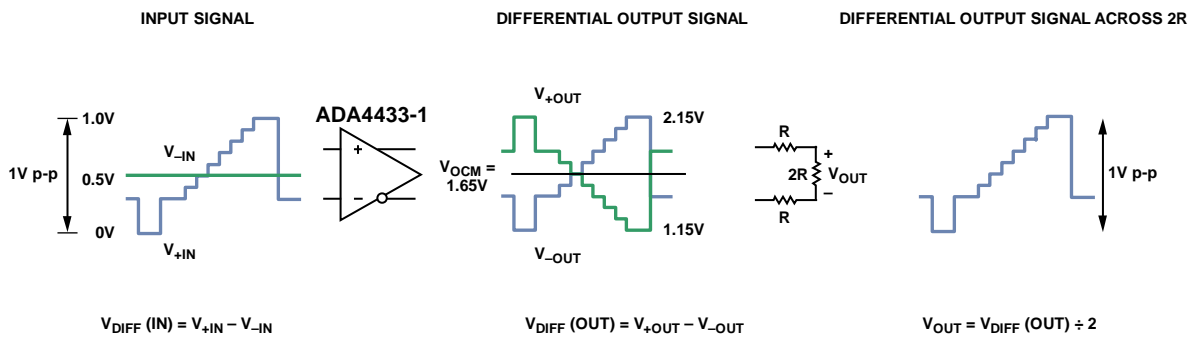

Figure 24. Single-Ended-to-Differential Configuration with Negative Input (-IN) Connected to 0.5 V

TYPICAL APPLICATION CIRCUIT



Figure 25. ADA4433-1 and ADV7391/ADV7393 Video Encoder Application Circuit

10897-034

FULLY DC-COUPLED TRANSMISSION LINE

The ADA4433-1 is designed to be used with high common-mode rejection, high input impedance receivers, such as the ADA4830-1, ADA4830-2, or other generic receivers.

The very low output impedance of the ADA4433-1 allows it to be used in fully dc-coupled transmission line applications in which there may be a significant discrepancy between voltage levels at the ground pins of the driver and receiver. As long as

the voltage difference between reference levels at the transmitter and receiver is within the common-mode range of the receiver, very little current flow results, and no image degradation is anticipated.

Figure 26 shows an example configuration of a completely dc-coupled transmission using the ADA4433-1 along with a high input impedance differential receiver.



Figure 26. ADA4433-1 Video Filter and ADA4830-1 Difference Amplifier in a DC-Coupled Configuration

10597-008

OUTLINE DIMENSIONS

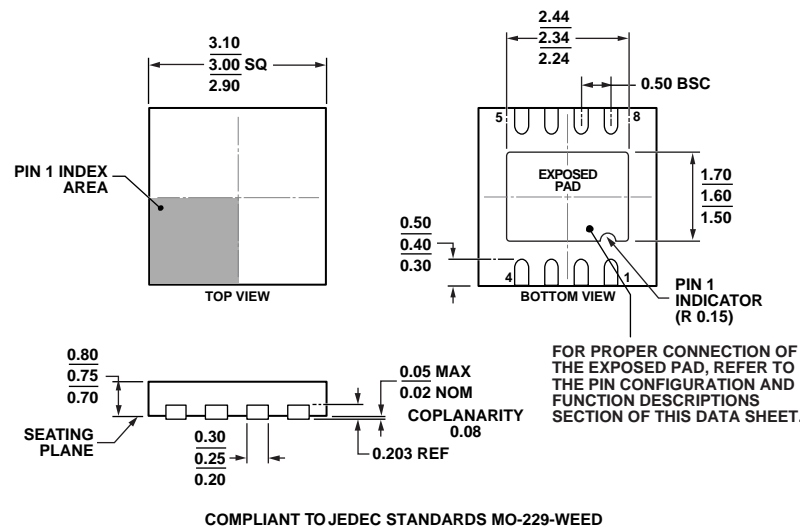

COMPLIANT TO JEDEC STANDARDS MO-229-WEED

Figure 27. 8-Lead Lead Frame Chip Scale Package [LFCSP_WD]
3 mm × 3 mm Body, Very Very Thin, Dual Lead
(CP-8-11)

Dimensions shown in millimeters

ORDERING GUIDE

Model ^{1, 2}	Temperature Range	Package Description	Package Option	Branding	Ordering Quantity
ADA4433-1BCPZ-R2	-40°C to +125°C	8-Lead Lead Frame Chip Scale Package [LFCSP_WD]	CP-8-11	331	250
ADA4433-1BCPZ-R7	-40°C to +125°C	8-Lead Lead Frame Chip Scale Package [LFCSP_WD]	CP-8-11	331	1500
ADA4433-1WBCPZ-R7	-40°C to +125°C	8-Lead Lead Frame Chip Scale Package [LFCSP_WD]	CP-8-11	H2Z	1500
ADA4433-1BCP-EBZ		Evaluation Board			

¹ Z = RoHS Compliant Part.

² W = Qualified for Automotive Applications.

AUTOMOTIVE PRODUCTS

The ADA4433-1W model is available with controlled manufacturing to support the quality and reliability requirements of automotive applications. Note that this automotive model may have specifications that differ from the commercial models; therefore, designers should review the Specifications section of this data sheet carefully. Only the automotive grade product shown is available for use in automotive applications. Contact your local Analog Devices account representative for specific product ordering information and to obtain the specific Automotive Reliability reports for this model.

Компания «Океан Электроники» предлагает заключение долгосрочных отношений при поставках импортных электронных компонентов на взаимовыгодных условиях!

Наши преимущества:

- Поставка оригинальных импортных электронных компонентов напрямую с производств Америки, Европы и Азии, а так же с крупнейших складов мира;
- Широкая линейка поставок активных и пассивных импортных электронных компонентов (более 30 млн. наименований);
- Поставка сложных, дефицитных, либо снятых с производства позиций;
- Оперативные сроки поставки под заказ (от 5 рабочих дней);
- Экспресс доставка в любую точку России;
- Помощь Конструкторского Отдела и консультации квалифицированных инженеров;
- Техническая поддержка проекта, помощь в подборе аналогов, поставка прототипов;
- Поставка электронных компонентов под контролем ВП;
- Система менеджмента качества сертифицирована по Международному стандарту ISO 9001;
- При необходимости вся продукция военного и аэрокосмического назначения проходит испытания и сертификацию в лаборатории (по согласованию с заказчиком);
- Поставка специализированных компонентов военного и аэрокосмического уровня качества (Xilinx, Altera, Analog Devices, Intersil, Interpoint, Microsemi, Actel, Aeroflex, Peregrine, VPT, Syfer, Eurofarad, Texas Instruments, MS Kennedy, Miteq, Cobham, E2V, MA-COM, Hittite, Mini-Circuits, General Dynamics и др.);

Компания «Океан Электроники» является официальным дистрибьютором и эксклюзивным представителем в России одного из крупнейших производителей разъемов военного и аэрокосмического назначения «JONHON», а так же официальным дистрибьютором и эксклюзивным представителем в России производителя высокотехнологичных и надежных решений для передачи СВЧ сигналов «FORSTAR».



JONHON

«JONHON» (основан в 1970 г.)

Разъемы специального, военного и аэрокосмического назначения:

(Применяются в военной, авиационной, аэрокосмической, морской, железнодорожной, горно- и нефтедобывающей отраслях промышленности)

«FORSTAR» (основан в 1998 г.)

ВЧ соединители, коаксиальные кабели, кабельные сборки и микроволновые компоненты:

(Применяются в телекоммуникациях гражданского и специального назначения, в средствах связи, РЛС, а так же военной, авиационной и аэрокосмической отраслях промышленности).



Телефон: 8 (812) 309-75-97 (многоканальный)

Факс: 8 (812) 320-03-32

Электронная почта: ocean@oceanchips.ru

Web: <http://oceanchips.ru/>

Адрес: 198099, г. Санкт-Петербург, ул. Калинина, д. 2, корп. 4, лит. А