



Is Now Part of



**ON Semiconductor®**

To learn more about ON Semiconductor, please visit our website at  
[www.onsemi.com](http://www.onsemi.com)

Please note: As part of the Fairchild Semiconductor integration, some of the Fairchild orderable part numbers will need to change in order to meet ON Semiconductor's system requirements. Since the ON Semiconductor product management systems do not have the ability to manage part nomenclature that utilizes an underscore (\_), the underscore (\_) in the Fairchild part numbers will be changed to a dash (-). This document may contain device numbers with an underscore (\_). Please check the ON Semiconductor website to verify the updated device numbers. The most current and up-to-date ordering information can be found at [www.onsemi.com](http://www.onsemi.com). Please email any questions regarding the system integration to [Fairchild\\_questions@onsemi.com](mailto:Fairchild_questions@onsemi.com).

ON Semiconductor and the ON Semiconductor logo are trademarks of Semiconductor Components Industries, LLC dba ON Semiconductor or its subsidiaries in the United States and/or other countries. ON Semiconductor owns the rights to a number of patents, trademarks, copyrights, trade secrets, and other intellectual property. A listing of ON Semiconductor's product/patent coverage may be accessed at [www.onsemi.com/site/pdf/Patent-Marking.pdf](http://www.onsemi.com/site/pdf/Patent-Marking.pdf). ON Semiconductor reserves the right to make changes without further notice to any products herein. ON Semiconductor makes no warranty, representation or guarantee regarding the suitability of its products for any particular purpose, nor does ON Semiconductor assume any liability arising out of the application or use of any product or circuit, and specifically disclaims any and all liability, including without limitation special, consequential or incidental damages. Buyer is responsible for its products and applications using ON Semiconductor products, including compliance with all laws, regulations and safety requirements or standards, regardless of any support or applications information provided by ON Semiconductor. "Typical" parameters which may be provided in ON Semiconductor data sheets and/or specifications can and do vary in different applications and actual performance may vary over time. All operating parameters, including "Typicals" must be validated for each customer application by customer's technical experts. ON Semiconductor does not convey any license under its patent rights nor the rights of others. ON Semiconductor products are not designed, intended, or authorized for use as a critical component in life support systems or any FDA Class 3 medical devices or medical devices with a same or similar classification in a foreign jurisdiction or any devices intended for implantation in the human body. Should Buyer purchase or use ON Semiconductor products for any such unintended or unauthorized application, Buyer shall indemnify and hold ON Semiconductor and its officers, employees, subsidiaries, affiliates, and distributors harmless against all claims, costs, damages, and expenses, and reasonable attorney fees arising out of, directly or indirectly, any claim of personal injury or death associated with such unintended or unauthorized use, even if such claim alleges that ON Semiconductor was negligent regarding the design or manufacture of the part. ON Semiconductor is an Equal Opportunity/Affirmative Action Employer. This literature is subject to all applicable copyright laws and is not for resale in any manner.



December 2014

# 4N38M, H11D1M, H11D3M, MOC8204M 6-Pin DIP High Voltage Phototransistor Optocouplers

## Features

- High Voltage:
  - MOC8204M,  $BV_{CEO} = 400\text{ V}$
  - H11D1M,  $BV_{CEO} = 300\text{ V}$
  - H11D3M,  $BV_{CEO} = 200\text{ V}$
- Safety and Regulatory Approvals:
  - UL1577, 4,170  $VAC_{RMS}$  for 1 Minute
- DIN-EN/IEC60747-5-5, 850 V Peak Working Insulation Voltage

## Applications

- Power Supply Regulators
- Digital Logic Inputs
- Microprocessor Inputs
- Appliance Sensor Systems
- Industrial Controls

## Description

The 4N38M, H11D1M, H11D3M, and MOC8204M are phototransistor-type optically coupled optoisolators. A gallium arsenide infrared emitting diode is coupled with a high voltage NPN silicon phototransistor. The device is supplied in a standard plastic six-pin dual-in-line package.

## Schematic



Figure 1. Schematic

## Package Outlines

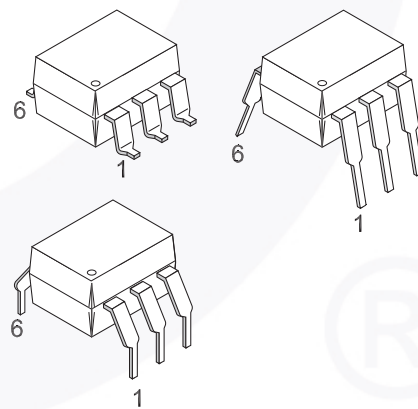

Figure 2. Package Outlines

4N38M, H11D1M, H11D3M, MOC8204M — 6-Pin DIP High Voltage Phototransistor Optocouplers

## Safety and Insulation Ratings

As per DIN EN/IEC 60747-5-5, this optocoupler is suitable for “safe electrical insulation” only within the safety limit data. Compliance with the safety ratings shall be ensured by means of protective circuits.

Parameter		Characteristics
Installation Classifications per DIN VDE 0110/1.89 Table 1, For Rated Mains Voltage	< 150 V <sub>RMS</sub>	I–IV
	< 300 V <sub>RMS</sub>	I–IV
Climatic Classification		55/100/21
Pollution Degree (DIN VDE 0110/1.89)		2
Comparative Tracking Index		175

Symbol	Parameter	Value	Unit
V <sub>PR</sub>	Input-to-Output Test Voltage, Method A, V <sub>IORM</sub> × 1.6 = V <sub>PR</sub> , Type and Sample Test with t <sub>m</sub> = 10 s, Partial Discharge < 5 pC	1360	V <sub>peak</sub>
	Input-to-Output Test Voltage, Method B, V <sub>IORM</sub> × 1.875 = V <sub>PR</sub> , 100% Production Test with t <sub>m</sub> = 1 s, Partial Discharge < 5 pC	1594	V <sub>peak</sub>
V <sub>IORM</sub>	Maximum Working Insulation Voltage	850	V <sub>peak</sub>
V <sub>IOTM</sub>	Highest Allowable Over-Voltage	6000	V <sub>peak</sub>
	External Creepage	≥ 7	mm
	External Clearance	≥ 7	mm
	External Clearance (for Option TV, 0.4" Lead Spacing)	≥ 10	mm
DTI	Distance Through Insulation (Insulation Thickness)	≥ 0.5	mm
T <sub>S</sub>	Case Temperature <sup>(1)</sup>	175	°C
I <sub>S,INPUT</sub>	Input Current <sup>(1)</sup>	350	mA
P <sub>S,OUTPUT</sub>	Output Power <sup>(1)</sup>	800	mW
R <sub>IO</sub>	Insulation Resistance at T <sub>S</sub> , V <sub>IO</sub> = 500 V <sup>(1)</sup>	> 10 <sup>9</sup>	Ω

### Note:

1. Safety limit values – maximum values allowed in the event of a failure.

## Absolute Maximum Ratings

Stresses exceeding the absolute maximum ratings may damage the device. The device may not function or be operable above the recommended operating conditions and stressing the parts to these levels is not recommended. In addition, extended exposure to stresses above the recommended operating conditions may affect device reliability. The absolute maximum ratings are stress ratings only.

Symbol	Parameter	Device	Value	Unit
<b>TOTAL DEVICE</b>				
T <sub>STG</sub>	Storage Temperature	All	-40 to +125	°C
T <sub>OPR</sub>	Operating Temperature	All	-40 to +100	°C
T <sub>J</sub>	Junction Temperature	All	-40 to +125	°C
T <sub>SOL</sub>	Lead Solder Temperature	All	260 for 10 seconds	°C
P <sub>D</sub>	Total Device Power Dissipation @ T <sub>A</sub> = 25°C	All	420	mW
	Derate Above 25°C		3.5	mW/°C
<b>EMITTER</b>				
I <sub>F</sub>	Forward DC Current <sup>(2)</sup>	All	80	mA
V <sub>R</sub>	Reverse Input Voltage <sup>(2)</sup>	All	6.0	V
I <sub>F(pk)</sub>	Forward Current – Peak (1 μs pulse, 300pps) <sup>(2)</sup>	All	3.0	A
P <sub>D</sub>	LED Power Dissipation @ T <sub>A</sub> = 25°C <sup>(2)</sup>	All	120	mW
	Derate Above 25°C		1.41	mW/°C
<b>DETECTOR</b>				
P <sub>D</sub>	Power Dissipation @ T <sub>A</sub> = 25°C	All	300	mW
	Derate linearly above 25°C		4.0	mW/°C
V <sub>CEO</sub>	Collector to Emitter Voltage <sup>(2)</sup>	MOC8204M	400	V
		H11D1M	300	V
		H11D3M	200	V
		4N38M	80	V
V <sub>CB0</sub>	Collector Base Voltage <sup>(2)</sup>	MOC8204M	400	V
		H11D1M	300	V
		H11D3M	200	V
		4N38M	80	V
V <sub>ECO</sub>	Emitter to Collector Voltage <sup>(2)</sup>	H11D1M, H11D3M, MOC8204M	7	V
I <sub>C</sub>	Collector Current (Continuous)	All	100	mA

### Note:

2. Parameters meet or exceed JEDEC registered data (for 4N38M only).

## Electrical Characteristics

$T_A = 25^\circ\text{C}$  unless otherwise specified.

### Individual Component Characteristics

Symbol	Characteristic	Test Conditions	Device	Min.	Typ.	Max.	Unit
<b>EMITTER</b>							
$V_F$	Forward Voltage <sup>(3)</sup>	$I_F = 10\text{ mA}$	All		1.15	1.50	V
$\frac{\Delta V_F}{\Delta T_A}$	Forward Voltage Temperature Coefficient		All		-1.8		mV/°C
$BV_R$	Reverse Breakdown Voltage	$I_R = 10\text{ }\mu\text{A}$	All	6	25		V
$C_J$	Junction Capacitance	$V_F = 0\text{ V}, f = 1\text{ MHz}$	All		50		pF
		$V_F = 1\text{ V}, f = 1\text{ MHz}$			65		pF
$I_R$	Reverse Leakage Current <sup>(3)</sup>	$V_R = 6\text{ V}$	All		0.05	10	$\mu\text{A}$
<b>DETECTOR</b>							
$BV_{CEO}$	Breakdown Voltage Collector-to-Emitter <sup>(3)</sup>	$R_{BE} = 1\text{ M}\Omega,$ $I_C = 1.0\text{ mA}, I_F = 0$	MOC8204M	400			V
			H11D1M	300			V
			H11D3M	200			V
			No RBE, $I_C = 1.0\text{ mA}$	4N38M	80		
$BV_{CBO}$	Collector to Base <sup>(3)</sup>	$I_C = 100\text{ }\mu\text{A}, I_F = 0$	MOC8204M	400			V
			H11D1M	300			V
			H11D3M	200			V
			4N38M	80			V
$BV_{EBO}$	Emitter to Base	$I_E = 100\text{ }\mu\text{A}, I_F = 0$	4N38M	7			V
$BV_{ECO}$	Emitter to Collector	$I_E = 100\text{ }\mu\text{A}, I_F = 0$	All	7	10		V
$I_{CEO}$	Leakage Current Collector to Emitter <sup>(3)</sup> ( $R_{BE} = 1\text{ M}\Omega$ )	$V_{CE} = 300\text{ V}, I_F = 0,$ $T_A = 25^\circ\text{C}$	MOC8204M			100	nA
		$V_{CE} = 300\text{ V}, I_F = 0,$ $T_A = 100^\circ\text{C}$				250	$\mu\text{A}$
		$V_{CE} = 200\text{ V}, I_F = 0,$ $T_A = 25^\circ\text{C}$	H11D1M			100	nA
		$V_{CE} = 200\text{ V}, I_F = 0,$ $T_A = 100^\circ\text{C}$				250	$\mu\text{A}$
		$V_{CE} = 100\text{ V}, I_F = 0,$ $T_A = 25^\circ\text{C}$	H11D3M			100	nA
		$V_{CE} = 100\text{ V}, I_F = 0,$ $T_A = 100^\circ\text{C}$				250	$\mu\text{A}$
			No $R_{BE}, V_{CE} = 60\text{ V},$ $I_F = 0, T_A = 25^\circ\text{C}$	4N38M			50

**Note:**

3. Parameters meet or exceed JEDEC registered data (for 4N38M only).

**Electrical Characteristics** (Continued) $T_A = 25^\circ\text{C}$  unless otherwise specified.**Transfer Characteristics**

Symbol	Characteristics	Test Conditions	Device	Min.	Typ.	Max.	Unit
<b>EMITTER</b>							
CTR	Current Transfer Ratio, Collector-to-Emitter	$I_F = 10\text{ mA}, V_{CE} = 10\text{ V}, R_{BE} = 1\text{ M}\Omega$	H11D1M, H11D3M, MOC8204M	2 (20)			mA (%)
		$I_F = 10\text{ mA}, V_{CE} = 10\text{ V}$	4N38M	2 (20)			mA (%)
$V_{CE(SAT)}$	Saturation Voltage <sup>(4)</sup>	$I_F = 10\text{ mA}, I_C = 0.5\text{ mA}, R_{BE} = 1\text{ M}\Omega$	H11D1M, H11D3M, MOC8204M		0.1	0.4	V
		$I_F = 20\text{ mA}, I_C = 4\text{ mA}$	4N38M			1.0	V
<b>SWITCHING TIMES</b>							
$t_{ON}$	Non-Saturated Turn-on Time	$V_{CE} = 10\text{ V}, I_C = 2\text{ mA}, R_L = 100\ \Omega$	All		5		$\mu\text{s}$
$t_{OFF}$	Turn-off Time		All		5		$\mu\text{s}$

**Note:**

4. Parameters meet or exceed JEDEC registered data (for 4N38M only).

**Isolation Characteristics**

Symbol	Characteristic	Test Conditions	Min.	Typ.	Max.	Unit
$V_{ISO}$	Input-Output Isolation Voltage	$t = 1\text{ Minute}$	4170			$V_{AC(RMS)}$
$C_{ISO}$	Isolation Capacitance	$V_{I-O} = 0\text{ V}, f = 1\text{ MHz}$		0.2		pF
$R_{ISO}$	Isolation Resistance	$V_{I-O} = \pm 500\text{ VDC}, T_A = 25^\circ\text{C}$	$10^{11}$			$\Omega$

## Typical Performance Curves

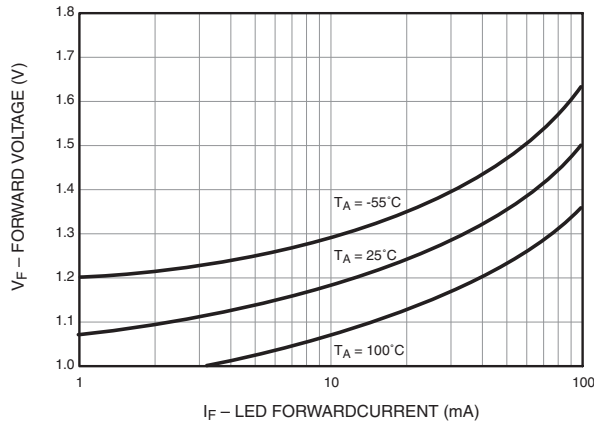

**Figure 3. LED Forward Voltage vs. Forward Current**

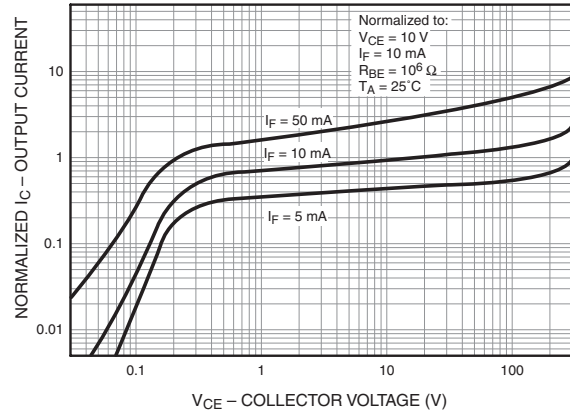

**Figure 4. Normalized Output Characteristics**

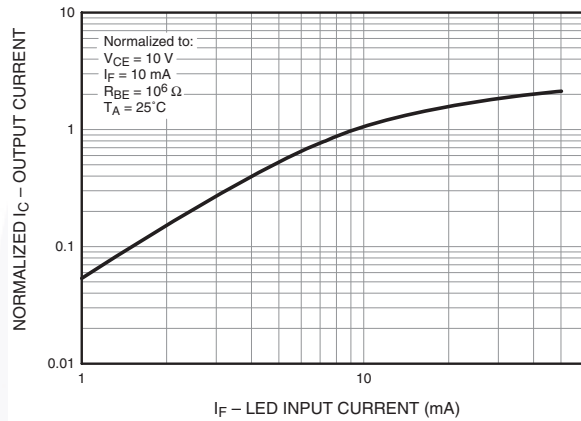

**Figure 5. Normalized Output Current vs. LED Input Current**

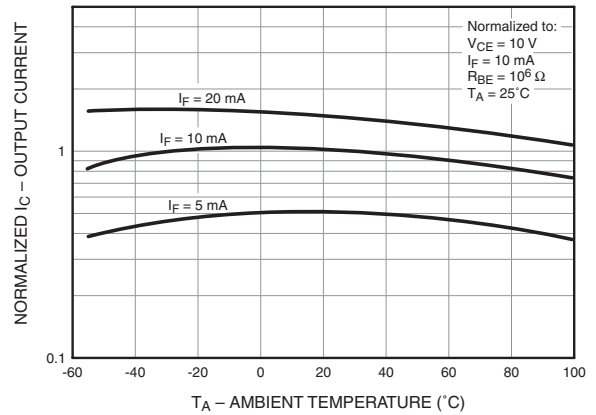

**Figure 6. Normalized Output Current vs. Temperature**

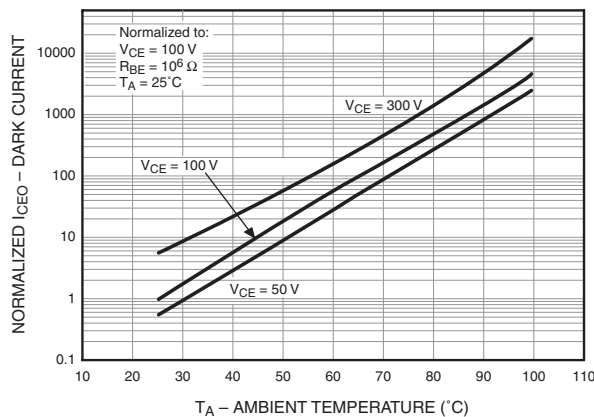

**Figure 7. Normalized Dark Current vs. Ambient Temperature**

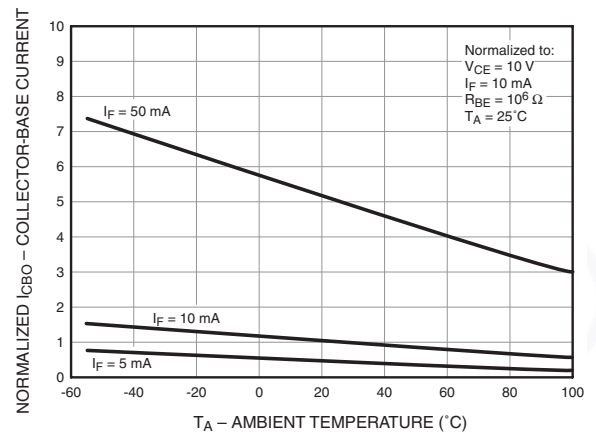

**Figure 8. Normalized Collector-Base Current vs. Temperature**

### Reflow Profile

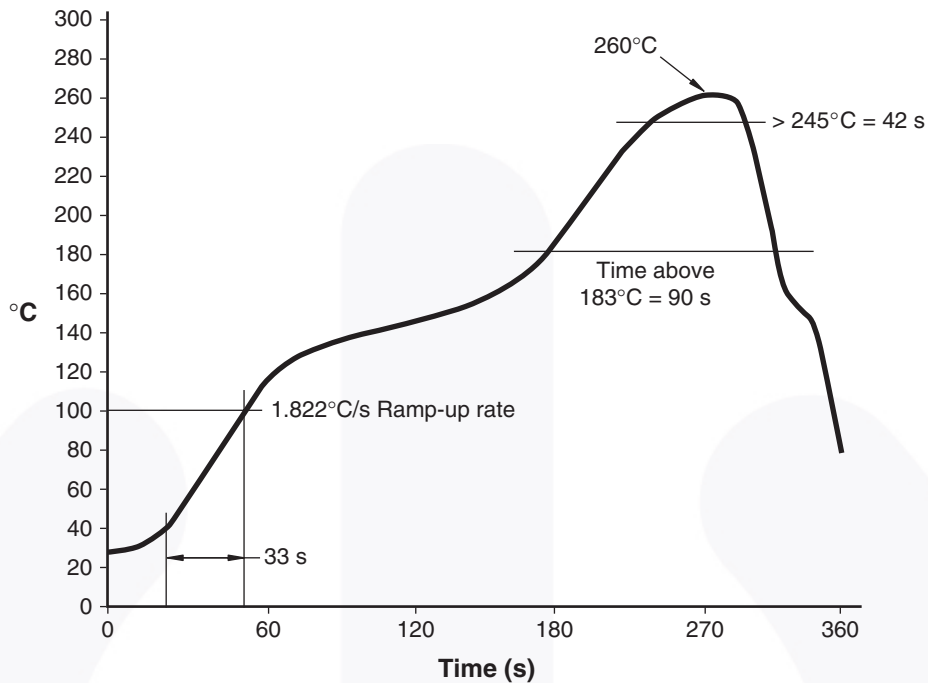

Figure 9. Reflow Profile



## Ordering Information

Part Number	Package	Packing Method
H11D1M	DIP 6-Pin	Tube (50 Units)
H11D1SM	SMT 6-Pin (Lead Bend)	Tube (50 Units)
H11D1SR2M	SMT 6-Pin (Lead Bend)	Tape and Reel (1000 Units)
H11D1VM	DIP 6-Pin, DIN EN/IEC60747-5-5 Option	Tube (50 Units)
H11D1SVM	SMT 6-Pin (Lead Bend), DIN EN/IEC60747-5-5 Option	Tube (50 Units)
H11D1SR2VM	SMT 6-Pin (Lead Bend), DIN EN/IEC60747-5-5 Option	Tape and Reel (1000 Units)
H11D1TVM	DIP 6-Pin, 0.4" Lead Spacing, DIN EN/IEC60747-5-5 Option	Tube (50 Units)

**Note:**

2. The product orderable part number system listed in this table also applies to the 4N38M, H11D3M, and MOC8204M devices.

## Marking Information



Figure 10. 12. Top Mark

Table 1. Top Mark Definitions

1	Fairchild Logo
2	Device Number
3	DIN EN/IEC60747-5-5 Option (only appears on component ordered with this option)
4	One-Digit Year Code, e.g., "4"
5	Digit Work Week, Ranging from "01" to "53"
6	Assembly Package Code



NOTES:

- A) NO STANDARD APPLIES TO THIS PACKAGE.
- B) ALL DIMENSIONS ARE IN MILLIMETERS.
- C) DIMENSIONS ARE EXCLUSIVE OF BURRS, MOLD FLASH, AND TIE BAR EXTRUSION
- D) DRAWING FILENAME AND REVISION: MKT-N06BREV4.





LAND PATTERN RECOMMENDATION



NOTES:

- A) NO STANDARD APPLIES TO THIS PACKAGE.
- B) ALL DIMENSIONS ARE IN MILLIMETERS.
- C) DIMENSIONS ARE EXCLUSIVE OF BURRS, MOLD FLASH, AND TIE BAR EXTRUSION
- D) DRAWING FILENAME AND REVISION : MKT-N06CREV4.





NOTES:

- A) NO STANDARD APPLIES TO THIS PACKAGE.
- B) ALL DIMENSIONS ARE IN MILLIMETERS.
- C) DIMENSIONS ARE EXCLUSIVE OF BURRS, MOLD FLASH, AND TIE BAR EXTRUSION
- D) DRAWING FILENAME AND REVISION: MKT-N06Drev4



ON Semiconductor and  are trademarks of Semiconductor Components Industries, LLC dba ON Semiconductor or its subsidiaries in the United States and/or other countries. ON Semiconductor owns the rights to a number of patents, trademarks, copyrights, trade secrets, and other intellectual property. A listing of ON Semiconductor's product/patent coverage may be accessed at [www.onsemi.com/site/pdf/Patent-Marking.pdf](http://www.onsemi.com/site/pdf/Patent-Marking.pdf). ON Semiconductor reserves the right to make changes without further notice to any products herein. ON Semiconductor makes no warranty, representation or guarantee regarding the suitability of its products for any particular purpose, nor does ON Semiconductor assume any liability arising out of the application or use of any product or circuit, and specifically disclaims any and all liability, including without limitation special, consequential or incidental damages. Buyer is responsible for its products and applications using ON Semiconductor products, including compliance with all laws, regulations and safety requirements or standards, regardless of any support or applications information provided by ON Semiconductor. "Typical" parameters which may be provided in ON Semiconductor data sheets and/or specifications can and do vary in different applications and actual performance may vary over time. All operating parameters, including "Typicals" must be validated for each customer application by customer's technical experts. ON Semiconductor does not convey any license under its patent rights nor the rights of others. ON Semiconductor products are not designed, intended, or authorized for use as a critical component in life support systems or any FDA Class 3 medical devices or medical devices with a same or similar classification in a foreign jurisdiction or any devices intended for implantation in the human body. Should Buyer purchase or use ON Semiconductor products for any such unintended or unauthorized application, Buyer shall indemnify and hold ON Semiconductor and its officers, employees, subsidiaries, affiliates, and distributors harmless against all claims, costs, damages, and expenses, and reasonable attorney fees arising out of, directly or indirectly, any claim of personal injury or death associated with such unintended or unauthorized use, even if such claim alleges that ON Semiconductor was negligent regarding the design or manufacture of the part. ON Semiconductor is an Equal Opportunity/Affirmative Action Employer. This literature is subject to all applicable copyright laws and is not for resale in any manner.

## PUBLICATION ORDERING INFORMATION

### LITERATURE FULFILLMENT:

Literature Distribution Center for ON Semiconductor  
19521 E. 32nd Pkwy, Aurora, Colorado 80011 USA  
**Phone:** 303-675-2175 or 800-344-3860 Toll Free USA/Canada  
**Fax:** 303-675-2176 or 800-344-3867 Toll Free USA/Canada  
**Email:** [orderlit@onsemi.com](mailto:orderlit@onsemi.com)

**N. American Technical Support:** 800-282-9855 Toll Free  
USA/Canada  
**Europe, Middle East and Africa Technical Support:**  
Phone: 421 33 790 2910  
**Japan Customer Focus Center**  
Phone: 81-3-5817-1050

**ON Semiconductor Website:** [www.onsemi.com](http://www.onsemi.com)  
**Order Literature:** <http://www.onsemi.com/orderlit>  
For additional information, please contact your local  
Sales Representative

# Mouser Electronics

Authorized Distributor

Click to View Pricing, Inventory, Delivery & Lifecycle Information:

[ON Semiconductor:](#)

[H11D1SM](#) [H11D1VM](#) [H11D1M](#) [H11D1SR2VM](#) [H11D1SR2M](#) [H11D1SVM](#)

Компания «Океан Электроники» предлагает заключение долгосрочных отношений при поставках импортных электронных компонентов на взаимовыгодных условиях!

Наши преимущества:

- Поставка оригинальных импортных электронных компонентов напрямую с производств Америки, Европы и Азии, а так же с крупнейших складов мира;
- Широкая линейка поставок активных и пассивных импортных электронных компонентов (более 30 млн. наименований);
- Поставка сложных, дефицитных, либо снятых с производства позиций;
- Оперативные сроки поставки под заказ (от 5 рабочих дней);
- Экспресс доставка в любую точку России;
- Помощь Конструкторского Отдела и консультации квалифицированных инженеров;
- Техническая поддержка проекта, помощь в подборе аналогов, поставка прототипов;
- Поставка электронных компонентов под контролем ВП;
- Система менеджмента качества сертифицирована по Международному стандарту ISO 9001;
- При необходимости вся продукция военного и аэрокосмического назначения проходит испытания и сертификацию в лаборатории (по согласованию с заказчиком);
- Поставка специализированных компонентов военного и аэрокосмического уровня качества (Xilinx, Altera, Analog Devices, Intersil, Interpoint, Microsemi, Actel, Aeroflex, Peregrine, VPT, Syfer, Eurofarad, Texas Instruments, MS Kennedy, Miteq, Cobham, E2V, MA-COM, Hittite, Mini-Circuits, General Dynamics и др.);

Компания «Океан Электроники» является официальным дистрибьютором и эксклюзивным представителем в России одного из крупнейших производителей разъемов военного и аэрокосмического назначения «JONHON», а так же официальным дистрибьютором и эксклюзивным представителем в России производителя высокотехнологичных и надежных решений для передачи СВЧ сигналов «FORSTAR».



## JONHON

«JONHON» (основан в 1970 г.)

Разъемы специального, военного и аэрокосмического назначения:

(Применяются в военной, авиационной, аэрокосмической, морской, железнодорожной, горно- и нефтедобывающей отраслях промышленности)

«FORSTAR» (основан в 1998 г.)

ВЧ соединители, коаксиальные кабели, кабельные сборки и микроволновые компоненты:

(Применяются в телекоммуникациях гражданского и специального назначения, в средствах связи, РЛС, а так же военной, авиационной и аэрокосмической отраслях промышленности).



Телефон: 8 (812) 309-75-97 (многоканальный)

Факс: 8 (812) 320-03-32

Электронная почта: [ocean@oceanchips.ru](mailto:ocean@oceanchips.ru)

Web: <http://oceanchips.ru/>

Адрес: 198099, г. Санкт-Петербург, ул. Калинина, д. 2, корп. 4, лит. А