

Amphenol®

Industrial Solar Technologies



Solar Line

PHOTOVOLTAIC INTERCONNECTION SYSTEM

ASIA

Amphenol Technology (Shenzhen) Co., Ltd
Building C, 2nd Industrial Zone of Xia Shi Jia
Gongming sub-district, Guangming New district
Shenzhen, China 518106
Telephone : +86 -755 -29918389

NORTH AMERICA

Amphenol Industrial Operations
191 Delaware Avenue
Sidney, New York 13838-1395 USA
Ph: +1-888-364-9011 Fax: +1-520-397-7169

Amphenol Industrial Solar Technologies
180 N Freeport DR. W-10, Nogales AZ 85621-2423
Telephone: +1-520-397-7047

EUROPE & THE MIDDLE EAST & AFRICA

Amphenol Industrial Operations Europe
Via Barbaiana n. 5-20020 Lainate-milano-Italy
Telephone: +39-348-3145390 Fax: 39-02-9325-4444

Amphenol Industrial Operations Middle East
Office No C-37, Ajman Free Zone-UAE
Telephone: +39-348-3145390 Fax: -9716-7422941

Amphenol®
Industrial Solar Technologies

E xpanding Global Presence

Founded in 1932, Amphenol is a global leader in interconnect technology, and is one of the world's largest connector manufacturers. Amphenol designs, manufactures, and markets solar products, electronic, and fiber optic connectors, interconnect systems, and coaxial and specialty cables.

Amphenol products are engineered and manufactured in the Americas, Europe, Asia, and Africa and sold by a worldwide sales and marketing organization. Amphenol has a diversified presence as a leader in high growth areas of the interconnect industry and provides solutions for customers in the automotive, broadband, industrial, information technology and data communications, military and aerospace, mobile devices, and mobile networks markets.

please click the hyperlink www.amphenol.com/about get more information.

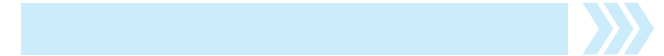
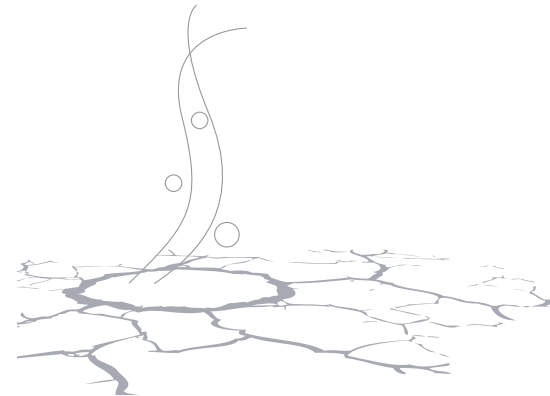

Table of Contents

| | |
|----------------------------|-----------|
| Connectors | Page1-18 |
| Cable and Cable assemblies | Page19-22 |
| Junction boxes | Page23-28 |
| Tools and Accessories | Page29-33 |



H4 PV Cable Connector

H4 Female PV Cable Connector

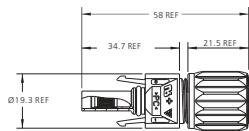

H4 Female socket contact

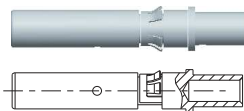

H4 Male PV Cable Connector

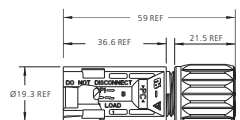

H4 Male pin contact

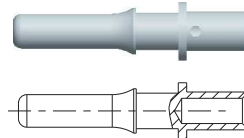

How to order

| Product family | Product | Gender | Connector type | Cable size | Approvals | Connector packaging | Contact* |
|----------------|-----------|-------------|--------------------|---|-----------------|---|--------------------|
| H4 | Helios H4 | C Connector | F Female M Male | C Cable gland 2 2.5mm ² /14 AWG 4 4.0mm ² /12 AWG&6.0mm ² /10 AWG (S&F) 4.0mm ² /12 AWG (C&F) 6.0mm ² /10 AWG (C&F) 8 10.0mm ² /8 AWG (C&F) 0 Less contacts | D Dual (TUV/UL) | I 1pcs/bag, 800pcs/box C 100pcs/bag, 10bags/box M 500 pcs/ bag, 2bags/box | S S&F Blank C&F |

Technical Data

| | |
|---------------------------|--|
| Rated current (IEC 85°C) | 25A(2.5mm ² /14AWG), 35A(4.0mm ² /12AWG) 45A(6.0mm ² /10AWG) |
| Rated voltage | 1000V DC (TUV) 1500V DC (UL) |
| Rated impulse voltage | 12KV(IEC) |
| Contact resistance | ≤0.30mΩ for S&F contact, ≤0.25mΩ for C&F contact ,TYP |
| Contact material | Copper, tin plated |
| Contact system | Stamped and Formed / Cold Formed contact with RADSOX® insert |
| Insulation material | PC/PA |
| Locking mechanism | Snap-lock, special unlocking tool required to un-mate as required by NEC2011 |
| Cable strain relief | Compression gland with ratcheting gland nut |
| Degree of protection | IP68 (1m, 1h) mated |
| Safety class | II |
| Pollution degree | 2 |
| Flame class | UL94 V-0 |
| Jacket of cable range | Ø4.5mm~Ø7.8mm |
| Ambient temperature range | -40°C~+85°C |

Ordering example:

- H4CFC4DMS H4 cable connector, female, 4.0mm²/12AWG & 6.0 mm²/10AWG S&F contact, 1000pcs per box
- H4CFC4DM H4 cable connector, female, 4.0mm²/12AWG C&F contact, 1000pcs per box

* Stamped and Formed (S&F) and Cold Formed (C&F) contact options

H4 Stamped and Formed Contact

Packaged on a reel for automatic assembly

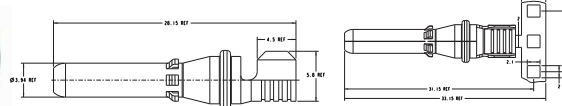
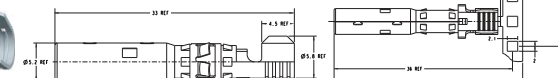
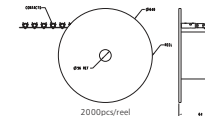

H4 S&F Contact Ordering Code (For Ordering Contacts on Reels)

| Product family | Contact type | Gender | Cable size | Packing | |
|----------------|--------------|---------------|--------------------|--|-------------|
| H4 | Helios H4 | F S&F contact | F Female M Male | 2 1.5mm ² /16AWG & 2.5mm ² /14AWG 4 4.0mm ² /12AWG & 6.0mm ² /10AWG | R 2000/reel |

Note: If ordering contacts in 2000pcs/reel version, need to order contact and plastic housing separately. Contact ordering code refers to this table, plastic housing should be chosen as H4CFC0DM for female housing and H4CMC0DM for male housing.

Ordering Example:

- H4CFC0DM: H4 Female housing assembly (1pcs)
- H4CMC0DM: H4 Male housing assembly (1pcs)
- H4FF4R H4 female contact on reel, 4.0mm²/12 AWG & 6.0mm²/10 AWG (2000pcs)
- H4FM2R H4 male contact on reel, 2.5mm²/14 AWG (2000pcs)

Assembly Tool



■ Tool-kit H4TK0000 ■ Unlock tool H4TU0000 ■ Wrench tool H4TW0001 ■ Strip tool H4TS0000 ■ Crimp tool for S&F contact H4TC0002 ■ Inspection tool H4TT0001
Crimp tool for C&F contact H4TC0001

■ More tools refer to page 29-33.

Enlarge H4 PV Cable Connector

Enlarge H4 Female Cable Connector

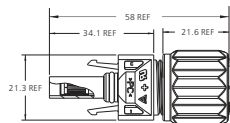

H4 Enlarge Female socket contact

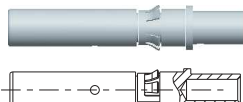

Enlarge H4 Male Cable Connector

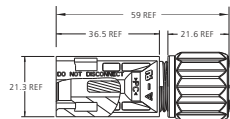

H4 Enlarge Male pin contact

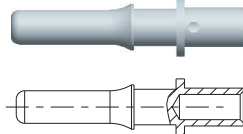

How to order

| Product family | Product | Gender | Connector type | Cable size | Approvals | Connector packaging |
|----------------|-------------|--------------------|------------------------|-----------------------------|-----------------|---|
| H4 Helios H4 | C Connector | F Female M Male | E H4 Enlarge connector | 8 10.0mm ² /8AWG | D Dual (TUV/UL) | I 1pcs/bag, 800pcs/box C 100pcs/bag, 8bag/box M 400pcs/bag, 2bags/box |

Technical Data

| | |
|---------------------------|---|
| Rated current | 50A(UL) 65A (TUV) |
| Rated voltage | 1000V DC (TUV/UL) |
| Rated impulse voltage | 12KV(IEC) |
| Contact resistance | ≤0.25mΩ,TYP |
| Contact material | Copper, tin plated |
| Contact size and system | 10.0mm ² /8AWG , Cold formed |
| Insulation material | PC/PA |
| Degree of protection | Ip68 (1m, 1h) mated |
| Safety class | II |
| Pollution degree | 2 |
| Flame class | UL94, V-0 |
| Jacket of cable range | Ø7.6mm~Ø9.3mm |
| Ambient temperature range | -40°C~+85°C |

Ordering example:

- H4CFE8DM Enlarge H4 cable connector, female , 10.0mm²/8AWG C&F contact, 800pcs per box
- H4CME8DM Enlarge H4 cable connector, male , 10.0mm²/8AWG C&F contact, 800pcs per box



H4TW0004
Wrench tool for Enlarge H4

H4 PV Panel Connector

H4 Female PV Panel Connector

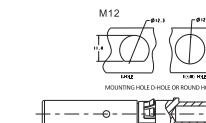
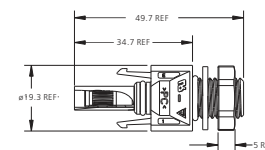

H4 Male PV Panel Connector

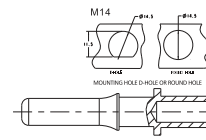
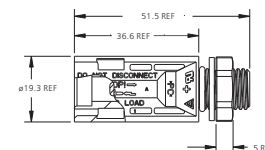

How to order

| Product family | Product | Gender | Connector type | Cable size | Approvals | Connector packaging | Contact * |
|----------------|-------------|--------------------|----------------------------------|--|-----------------|---|--------------------|
| H4 Helios H4 | C Connector | F Female M Male | M bulkhead M12 N bulkhead M14 | 2 2.5mm ² /14 AWG 4 4.0mm ² /12 AWG&6.0mm ² /10 AWG (S&F) 4 4.0mm ² /12 AWG (C&F) 6 6.0mm ² /10 AWG (C&F) 8 10.0mm ² /8 AWG (C&F) 0 Less contacts | D Dual (TUV/UL) | I 1pcs/bag, 800pcs/box C 100pcs/bag, 10bags/box M 500 pcs/ bag, 2bags/box | S S&F Blank C&F |

Technical Data

| | |
|---------------------------|--|
| Rated current (IEC 85°C) | 25A(2.5mm ² /14AWG), 35A(4.0mm ² /12AWG) 45A(6.0mm ² /10AWG) |
| Rated voltage | 1500V DC (TUV) 1500V DC (UL) |
| Rated impulse voltage | 16KV(IEC) |
| Contact resistance | ≤0.30mΩ for S&F contact, ≤0.25mΩ for C&F contact,TYP |
| Contact material | Copper, tin plated |
| Contact system | Stamped and Formed / Cold Formed contact with RADSOK® insert |
| Insulation material | PC/PA |
| Degree of protection | IP68 (1 meter, 1 hour) mated |
| Safety class | II |
| Pollution degree | 2 |
| Flame class | UL94 V-0 |
| Jacket of cable range | Ø4.5mm~Ø7.8mm |
| Ambient temperature range | -40°C~+85°C |

Ordering example:

- H4CFM4DMS H4 bulkhead M12 connector, female , 4.0mm²/12AWG & 6.0 mm²/10AWG S&F contact, 1000pcs per box
- H4CFM4DM H4 bulkhead M12 connector, female , 4.0mm²/12AWG C&F contact, 1000pcs per box

* Stamped and Formed (S&F) and Cold Formed (C&F) contact options

* If ordering contacts in 2000pcs/reel version, please refer to page 02.

H4-H PV Cable Connector

H4-H Female PV Cable Connector

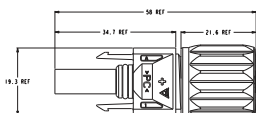

H4 Female socket contact

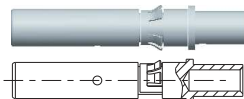

H4-H Male PV Cable Connector

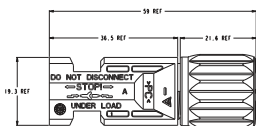

H4 Male pin contact

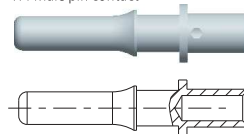

R 50157783

How to order

| Product family | Product | Gender | Connector type | Cable size | Approvals | Connector packaging | Contact* |
|----------------|-----------|-------------|--------------------|----------------------------|--|--|--------------------|
| H4 | Helios H4 | C Connector | F Female M Male | D Manually cable connector | 2 2.5mm ² 4 4.0mm ² /6.0mm ² (S&F) 4.0mm ² (C&F) 6 6.0mm ² (C&F) 8 10.0mm ² (C&F) 0 Less contacts | T TUV I 1pcs/bag, 800pcs/box C 100pcs/bag, 10bags/box M 500 pcs/ bag, 2bags/box | S S&F Blank C&F |

Technical Data

| | |
|---------------------------|--|
| Rated current (IEC) | 25A(2.5mm ² /14AWG), 35A(4.0mm ² /12AWG), 45A(6.0mm ² /10AWG) |
| Rated voltage | 1000V DC |
| Contact resistance | ≤0.30mΩ for S&F contact, ≤0.25mΩ for C&F contact, TYP |
| Contact material | Copper, tin plated |
| Contact system | Stamped and Formed / Cold Formed contact |
| Insulation material | Thermoplastic |
| Degree of protection | IP68 (1 meter, 1 hour) mated |
| Flame class | UL94 V-0 |
| Jacket of cable range | Ø4.5mm~Ø7.8mm |
| Ambient temperature range | -40°C~+85°C |

Ordering example:

- H4CFD4TMS H4-H manually cable connector, female, 4.0mm²/12AWG & 6.0mm²/10AWG S&F contact, 1000pcs per box
- H4CFD4TM H4-H manually cable connector, female, 4.0mm²/12AWG C&F contact, 1000pcs per box

* Stamped and Formed (S&F) and Cold Formed (C&F) contact options
* If ordering contacts in 2000pcs/reel version, please refer to page 02.

H4-H PV Panel Connector

H4-H Female PV Panel Connector

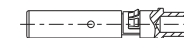
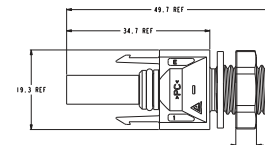

H4-H Male PV Panel Connector

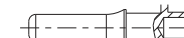
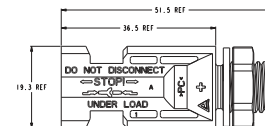

R 50157783

How to order

| Product family | Product | Gender | Connector type | Cable size | Approvals | Connector packaging | Contact* |
|----------------|-----------|-------------|--------------------|-------------------------------|--|--|--------------------|
| H4 | Helios H4 | C Connector | F Female M Male | B Manually bulkhead connector | 2 2.5mm ² 4 4.0mm ² /6.0mm ² (S&F) 4.0mm ² (C&F) 6 6.0mm ² (C&F) 8 10.0mm ² (C&F) 0 Less contacts | T TUV I 1pcs/bag, 800pcs/box C 100pcs/bag, 10bags/box M 500 pcs/ bag, 2bags/box | S S&F Blank C&F |

Technical Data

| | |
|---------------------------|--|
| Rated current (IEC) | 25A(2.5mm ² /14AWG), 35A(4.0mm ² /12AWG), 45A(6.0mm ² /10AWG) |
| Rated voltage | 1500V DC |
| Contact resistance | ≤0.30mΩ for S&F contact, ≤0.25mΩ for C&F contact, TYP |
| Contact material | Copper, tin plated |
| Contact system | Stamped and Formed / Cold Formed contact |
| Insulation material | Thermoplastic |
| Degree of protection | IP68 (1 meter, 1 hour) mated |
| Flame class | UL94 V-0 |
| Jacket of cable range | Ø4.5mm~Ø7.8mm |
| Ambient temperature range | -40°C~+85°C |

Ordering example:

- H4CFB4TMS H4-H manually bulkhead connector, female, 4.0mm²/12AWG & 6.0mm²/10AWG S&F contact, 1000pcs per box
- H4CFB4TM H4-H manually bulkhead connector, female, 4.0mm²/12AWG C&F contact, 1000pcs per box

* Stamped and Formed (S&F) and Cold Formed (C&F) contact options
* If ordering contacts in 2000pcs/reel version, please refer to page 02.

UTX™ PV Cable Connector

UTX™ Female Cable Connector

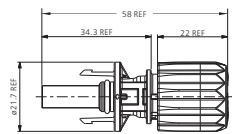

UTX™ Female socket contact



UTX™ Male Cable Connector

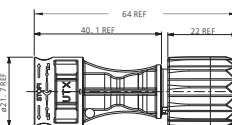

UTX™ Male pin contact



UTX Stamped and Formed Contact

Packaged on a reel for automatic assembly

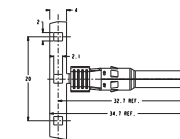
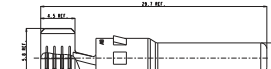
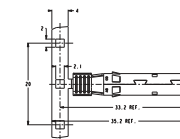
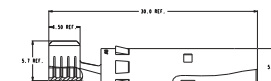
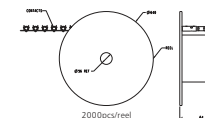

How to order

| Product family | Product Type | Gender | Contact type* |
|--|------------------------|--|---|
| UTX UTX | C Connector | F Female M Male | A Stamped and Formed Contact (S&F) B Cold Formed Contact (C&F) |
| Cable Size | Approvals | Packaging | |
| 2 2.5mm ² /14 AWG 4 4.0mm ² /12 AWG&6.0mm ² /10 AWG (S&F) 4 4.0mm ² /12 AWG (C&F) 6 6.0mm ² /10 AWG (C&F) 0 Less contacts | A TÜV/UL/JET Certified | C 100 pcs/bag ,8 bags/box M 400 pcs/bag ,2 bags/box | |

Technical Data

| | |
|---------------------------|--|
| Rated current (IEC85°C) | 25A(2.5mm ² /14AWG), 35A(4.0mm ² /12AWG) 45A(6.0mm ² /10AWG) |
| Rated voltage | 1500V DC(TUV/UL/JET) |
| Contact resistance | ≤0.30mΩ for S&F contact, ≤0.25mΩ for C&F contact, TYP |
| Contact material | Copper ,tin plated |
| Contact system | Stamped and Formed / Cold Formed contact |
| Insulation material | Thermoplastic |
| Degree of protection | Ip68 (1 m, 1h) mated |
| Flame class | UL94, V-0 |
| Jacket of cable range | Ø5.3mm – Ø7.65mm |
| Ambient temperature range | -40°C – +85°C |

Ordering example:

- UTXCFA4AM UTX cable connector, female, 4.0mm²/12AWG & 6.0 mm²/10AWG S&F contact, 800pcs per box
- UTXCFB4AM UTX cable connector, female, 4.0mm²/12AWG C&F contact, 800pcs per box

* Stamped and Formed (S&F) and Cold Formed (C&F) contact options

UTX S&F Contact Ordering Code (For Ordering Contacts on Reels)

| Product family | Product type | Gender | Contact size* | Packaging |
|----------------|---------------|--------------------|--|-----------------|
| UTX UTX | F S&F Contact | F Female M Male | 2 2.5mm ² /14AWG 4 4.0mm ² /12AWG&6.0mm ² /10AWG | R 2000 pcs/reel |

Note: If ordering contacts in 2000pcs/reel version, need to order contact and plastic housing separately. Contact ordering code refers to this table, plastic housing should be chosen as UTXCFA0AM for female housing and UTXCMA0AM for male housing.

Ordering Example:

- UTXCFA0AM: UTX Female housing assembly (1pcs)
- UTXCMA0AM: UTX Male housing assembly (1pcs)
- UTXFF4R UTX female contact on reel, 4.0mm²/12 AWG & 6.0mm²/10 AWG (2000pcs)
- UTXFM2R UTX male contact on reel, 2.5mm²/14 AWG (2000pcs)

Assembly Tool



■ Tool-kit H4TK0000 ■ Unlock tool H4TU0000 ■ Wrench tool UTXTWA001 ■ Strip tool H4TS0000 ■ Crimp tool for S&F contact UTXTC0002 ■ Inspection tool UTXIT0001
Crimp tool for C&F contact UTXTC0001

■ More tools refer to page 29-33.

UTX™-XL PV Cable Connector

UTX™-XL Female Cable Connector

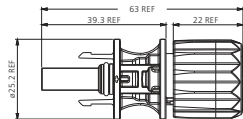

UTX™-XL Female socket contact

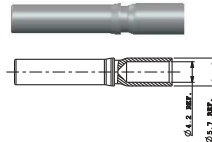

UTX™-XL Male Cable Connector

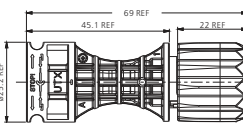

UTX™-XL Male pin contact

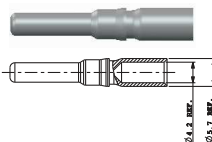

R 50283691



E 469330

How to order

| Product family | Product Type | Gender | Contact type | Cable size | Approvals | Packaging |
|----------------|--------------|--------------------|--------------|-----------------------------|----------------|---------------------------|
| UTX UTX | C Connector | F Female M Male | L UTX-XL | 8 10.0mm ² /8AWG | A DUAL(TUV/UL) | M 250 pcs/bag ,2 bags/box |

Technical Data

| | |
|---------------------------|--|
| Rated current | 75A (EN85°C) , 50A (UL) |
| Rated voltage | 1500V DC |
| Contact resistance | ≤0.25mΩ,TYP |
| Degree of protection | Ip68 (1m, 1h) mated |
| Contact material | Copper, tin plated |
| Contact size and Type | 10mm ² /8AWG, Cold formed contact |
| Insulation material | Thermoplastic |
| Flame class | UL94 , V-0 |
| Jacket of cable range | Ø7.6mm-Ø9.3mm |
| Ambient temperature range | -40°C~+85°C |

Ordering example:

UTXCFL8AM:UTX-XL cable connector, Female end ,10.0mm²/8AWG C&F contact, 500pcs per box
UTXCML8AM:UTX-XL cable connector, Male end ,10.0mm²/8AWG C&F contact, 500pcs per box



UTX™-XL Connector Wrench Tool
P/N: UTXW001

UTX™ PV Panel Connector

UTX Female Panel Connector

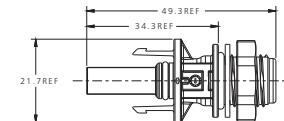

UTX Male Panel Connector

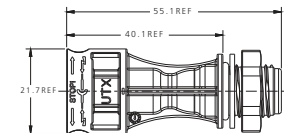

R 50340393



E 469330

How to order

| Product family | Product | Gender | Contact type* |
|--|----------------------------------|--------------------|--|
| UTX UTX | M Bulkhead M12 N Bulkhead M14 | F Female M Male | A Stamped and Formed Contact (S&F) B Cold Formed Contact(C&F) |
| Cable Size* | | Approvals | Packaging |
| 2 2.5mm ² /14 AWG 4 4.0mm ² /12 AWG & 6.0mm ² /10 AWG (S&F) 4.0mm ² /12 AWG (C&F) 6 6.0mm ² /12 AWG (C&F) 0 Less contacts | | A TÜV/UL Certified | I 1pcs/bag, 800pcs/box C 100 pcs/bag ,8 bags/box M 400 pcs/bag ,2 bags/box |

Technical Data

| | |
|---------------------------|--|
| Rated current (IEC) | 25A (2.5mm ² /14AWG) , 35A (4.0mm ² /12AWG) 45A (6.0mm ² /10AWG) |
| Rated voltage | 1500V DC (TUV/UL) |
| Contact resistance | ≤0.30mΩ for S&F contact, ≤0.25mΩ for C&F contact,TYP |
| Contact material | Copper, tin plated |
| Contact system | Stamped and Formed / Cold Formed contact |
| Insulation material | Thermoplastic |
| Degree of protection | IP68 |
| Cable applicability | 2.5mm ² ~6.0mm ² |
| Flame class | UL94, V-0 |
| Ambient temperature range | -40°C~+85°C |

Ordering example:

- UTXMFA4AM UTX M12 bulkhead, female , 4.0mm²/12AWG & 6.0 mm²/10AWG S&F contact, 800pcs per box
- UTXMFB4AM UTX M12 bulkhead, female , 4.0mm²/12AWG C&F contact, 800pcs per box

* Stamped and Formed (S&F) and Cold Formed (C&F) contact options

* If ordering contacts in 2000pcs/reel version, please refer to page 08.

H4-R PV Connector

H4-R Female Cable Connector

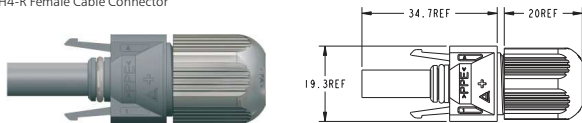

H4-R Male Cable Connector

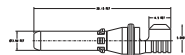

H4-R Female Panel Connector

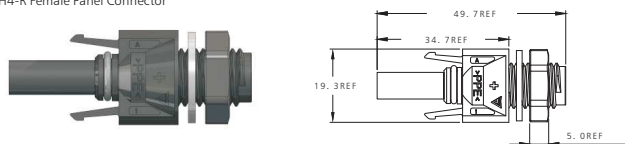

H4-R Male Panel Connector

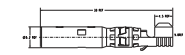
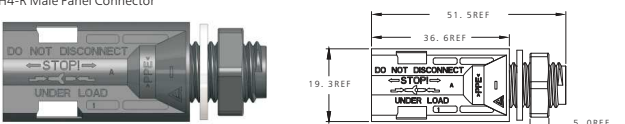

H4-RH PV Connector

H4-RH Female Cable Connector

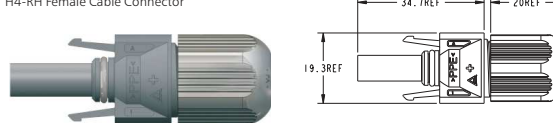

H4-RH Male Cable Connector

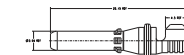
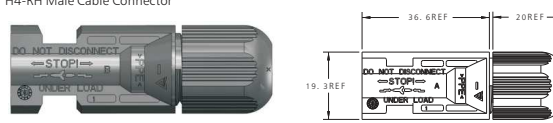

H4-RH Female Panel Connector

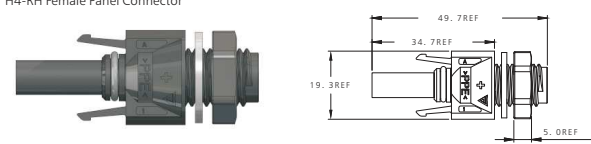

H4-RH Male Panel Connector

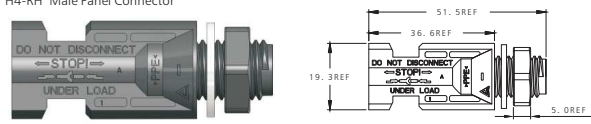

How to order

| Product family | Product type | Gender | Connector type |
|--|------------------|---|--|
| H4 H4 | L H4-R connector | F Female M Male | C Cable connector_H4-R M Bulkhead M12_H4-R B Bulkhead M12_H4-RH D Cable connector_H4-RH |
| Cable size | Approvals | Packaging | Contact* |
| 2 2.5 mm ² 4 4.0 mm ² & 6.0 mm ² | T TUV | C 100pcs/bag, 10bags/box M 500pcs/bag, 2bags/box | S S&F contact |

Ordering example:

- H4LFC4TMS H4-R type, female cable connector, 4mm² & 6mm² S&F contact, 1000pcs per box
- H4LFM4TMS H4-R type, female panel connector, 4mm² & 6mm² S&F contact, 1000pcs per box
- H4LFD4TMS H4-RH type, female cable connector, 4mm² & 6mm² S&F contact, 1000pcs per box
- H4LFB4TMS H4-RH type, female panel connector, 4mm² & 6mm² S&F contact, 1000pcs per box

* If ordering contacts in 2000pcs/reel version, please refer to page 02.

Technical Data

| | |
|---------------------------|--|
| Rated current (IEC85°C) | 25A for 2.5mm ² , 35A for 4.0mm ² , 45A for 6.0mm ² |
| Rated voltage | 1100V DC (TUV) |
| Contact resistance | ≤0.3mΩ, TYP |
| Contact material | Copper, tin plated |
| Contact system | Stamped formed contact |
| Insulation material | Thermoplastic |
| Degree of protection | IP68 (1m, 1h) mated |
| Cable applicability | 2.5mm ² ~6.0mm ² |
| Flame class | UL94, V-0 |
| Jacket of cable range | Ø5.94mm~Ø6.97mm |
| Ambient temperature range | -40°C~+85°C |

Assembly Tool



■ Tool-kit H4TK0000 ■ Lock tool H4TU0000 ■ Wrench tool H4TW0001 ■ Strip tool H4TS0000 ■ Crimp tool H4TC0002 ■ Inspection tool H4TT0001

■ More tools refer to page 29-33.

H4 Branch Connector

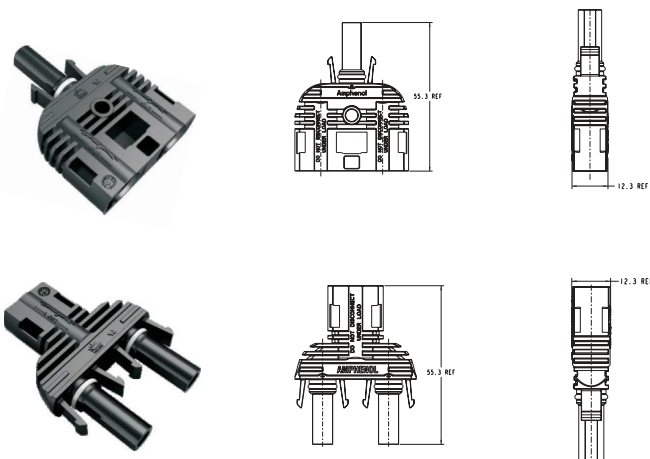

How to order

| Product family | Product type | Gender |
|----------------|--------------------|--|
| H4 Helios H4 | Y Branch connector | X FFM (branch 2 female/1 male) Y MMF (branch 2 male/1 female) |

Technical Data

| | |
|-----------------------------|----------------------------|
| Rated current | 30A max. |
| Rated voltage | 1000V DC(UL) 1500V DC(ETL) |
| Contact resistance | 0.50mΩ TYP |
| Contact material | Copper, tin plated |
| Insulation material | Thermoplastic, UL94 V-0 |
| Degree of protection(mated) | IP68(1m, 1h) |
| Ambient temperature range | -40°C ~ +90°C |

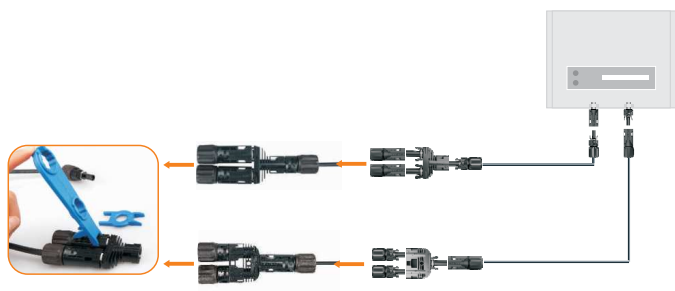

Branch Fuse Connector

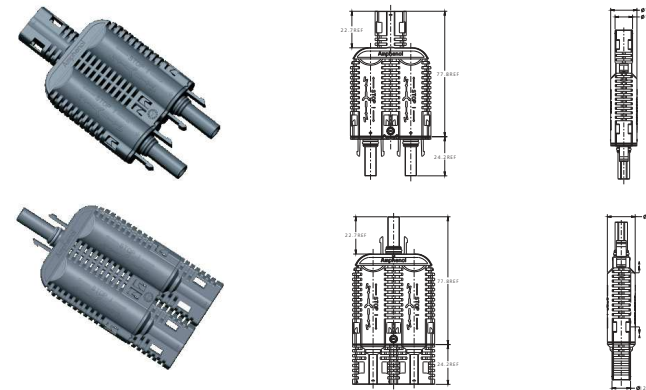

How to order

| Product family | Product | Gender |
|---------------------------|---|--|
| H4 Helios H4 | Y Branch connector | FFM Branch 2 female/1 male MMF Branch 2 male/1 female |
| Fuse range | Fuse current (1~30A) | Variations |
| A 16A~30A B 1~15A fuse | 01 1A 15 15A 30 30A | A Unlock type |

Technical Data

| | |
|---------------------------|---------------------|
| Rated current of fuse | 1A~30A |
| Rated voltage | 1000V |
| Contact resistance | 12mΩ Typ |
| Degree of protection | IP68 (1m, 1h) mated |
| Number of fuse | 2 |
| Contact material | Copper, Tin plated |
| Insulation material | Thermoplastic |
| Ambient temperature range | -40°C~+85°C |

Ordering example:

- H4YFFMB15A 1000V branch fuse connector , 2female/1male, 15A

1500V Inline Fuse Connector

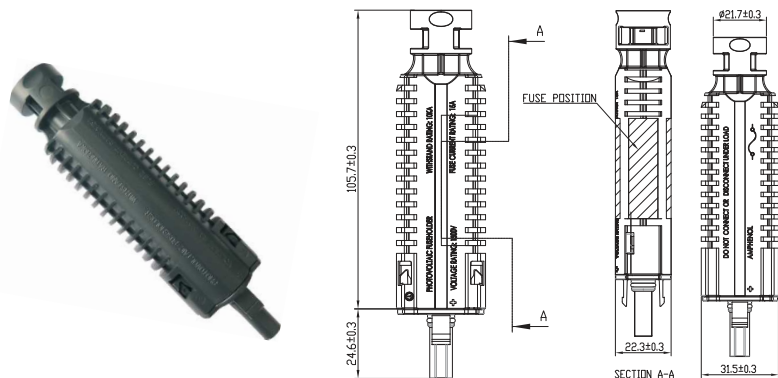

| How to order | | | | |
|----------------|------------------|-------------------|--------------|--------------------------|
| Product family | Product | Connector Type | Fuse Voltage | Fuse Current rating |
| UTX UTX | G Assembled fuse | FM Female to Male | 3 1500V | 01 1A 15 15A |

| Technical Data | |
|---------------------------|-------------------------|
| Rated voltage | 1500V DC |
| Rated current of fuse | 1A to 15A |
| Protection degree(mated) | IP68 |
| Number of fuse | 1 |
| Replaceable of use | No |
| Contact material | Copper, Tin plated |
| Insulation material | Thermoplastic, UL94 V-0 |
| Ambient temperature range | -40°C~+85°C |

Ordering example:

- UTXGM315 1500V UTX Inline fuse connector, 15A current

1000V Inline Fuse Connector

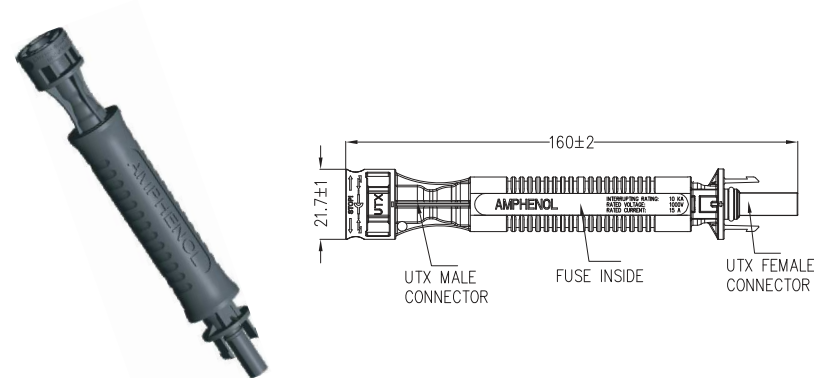

| How to order | | | | |
|----------------|---------------|-------------------|--------------|---|
| Product family | Product | Connector Type | Fuse Voltage | Fuse Current rating |
| UTX UTX type | F Molded fuse | FM Female to Male | 2 1000V | 01 1A 15 15A 30 up to 30A |

| Technical Data | |
|-----------------------------|---------------------------|
| Interrupting rating | 10KA |
| Voltage rating | 1000V max |
| Amperage rating | 30A max |
| Connector options | M-F |
| Degree of protection(mated) | IP68 |
| Cable range | 2.5mm²/14AWG~10.0mm²/8AWG |
| Ambient temperature range | -40°C ~ +90°C |

Ordering example:

- UTXFFM215 1000V UTX Inline fuse connector, 15A current

HelioLug

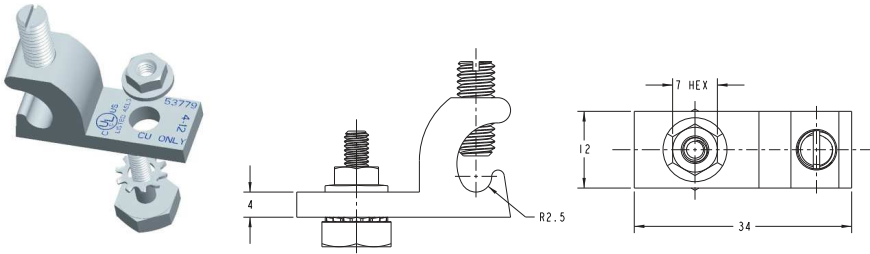

INSTALLATION INSTRUCTIONS:

- Place the lug to the designated module grounding hole with the star washer between the grounding lug and the module frame in order to break through the anodizing and establish electrical contact with the aluminum. Torque the bolt and nut to 30 in-lbs. NOTE: These instructions provide guidelines for general use. If available, the specific module manufacturer's instructions for the location of the star washer are to be followed.

- For the attachment to the racking, slide the bolt into the mounting channel of the extrusion or into a 1/8" Hole drilled through the extrusion. Place the star washer between the racking and lug and secure the nut and bolt to 30 in-lbs. NOTE:

- Insert a 4 to 12 AWG copper wire into the lug and tighten the lug set screw to the copper wire to the torque based on the wire size. (4-6 AWG at 35 in-lbs and 8-12 AWG at 30 in-lbs). Do not exceed the maximum rated overcurrent protection, 20 A (12 AWG), 40 A (10 AWG), 90 A (8 AWG), 150 A (6 AWG), and 200 A (4 AWG).

Certified to UL2703 and cUL QIMS7 for Photovoltaic Bonding



| How to order | | |
|---------------------|----------------------------------|-----------|
| Product Family | Type | Approvals |
| HG Helios Grounding | L HelioLug (4~12AWG copper wire) | U UL 2703 |

Helio Clip™

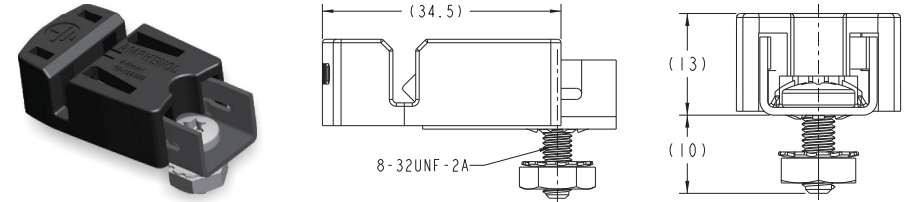

Designed for UL2703 - PV Racking and Grounding

| How to order | | |
|---------------------|---|---------------------|
| Product family | Type | Approvals |
| HG Helios Grounding | C HelioClip Selftapping (10~12AWG copper wire) D HelioClip Mounting (10~12AWG copper wire) | U UL 2703 (Pending) |

Helio Bolt™

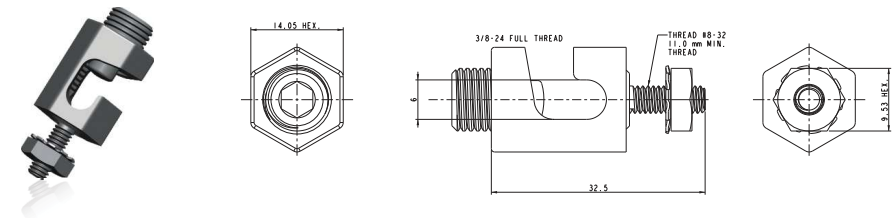

Certified to UL2703 - PV Racking and Grounding



| How to order | | |
|---------------------|--|-----------|
| Product family | Type | Approvals |
| HG Helios Grounding | M HelioBolt Mounting (6~12AWG copper wire) | U UL 2703 |

-100% Passivated Stainless Steel

PowerLink solar cable

Halogen free photovoltaic cables are used as the interconnection wiring for photovoltaic power systems.

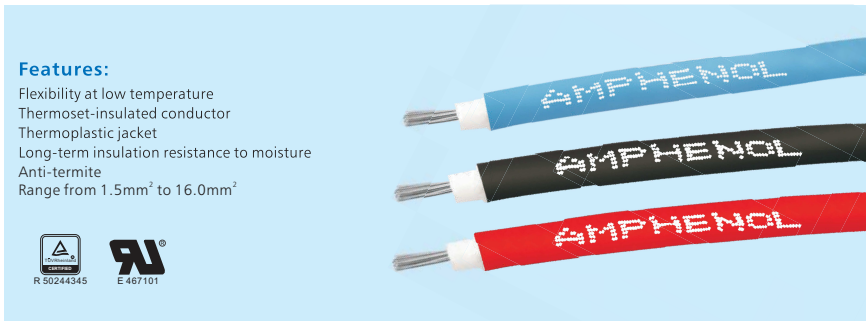

Features:

- Flexibility at low temperature
- Thermoset-insulated conductor
- Thermoplastic jacket
- Long-term insulation resistance to moisture
- Anti-termite
- Range from 1.5mm² to 16.0mm²



Certificate:

- EN50618, 1500V
- TÜV 2 PFG 1169/08.2007 PV1-F
- TÜV 2 PFG 1990/05.2012 PV 1500 DC-F
- UL 4703 PV wire, cTUVus
- UL 4703 PV wire, 600V, 1000V, 2000V

Structure:

- Conductor: Stranded bare or tinned copper
- Insulation: XLPE material (white and black)
- Jacket: XLPE material (Black, Red and Blue)

Temperature range:
-40 °C to +90 °C

Environmental influence resistance:
Acid, alkalinity, UV, ozone and hydrolysis-resistant.

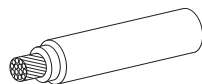
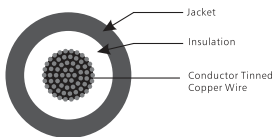

PowerLink solar cable application:

Used in heavy-duty and harsh environment interconnection wiring, can be easily combined with our Helios H4 PV connector and junction box series for photovoltaic system applications.



Cold
Snow
Low temperature



Sun
Drought
High temperature



Rain
Moisture

How to order

| Product family | Product | Cable color | Cable type |
|---|--|---|--|
| HC Helios cable | P Powerlink -standard A Armorlink-Rodent Proof U Powerlink- USE-2 | B Black R Red L Blue G Grey O Brown | L VDE 0295-CLASS 2 7 Strands(USE-2) M Mult wire 19 strands (UL only) H VDE 0295-CLASS 5(UL,TUV and Dual) |
| Cable size | Approvals | Spec | Jacket type |
| 1 1.5mm ² /16AWG 2 2.5mm ² /14AWG 4 4.0mm ² /12AWG 5 25.0mm ² /3AWG 6 6.0mm ² /10AWG 8 10.0mm ² /8AWG 9 16.0mm ² /4AWG | T0 TUV 1000V D0 Dual UL600V TUV 1000V D1 Dual UL 1000V TUV 1000V U0 UL 600V U1 UL 1000V U2 UL 2000V E1 EN 1500V E2 Dual EN 1500V UL 2000V | 0 Normal spec 1 New extra thin | 0 normal type |

Notes:

- UL cable comes in AWG only
- TUV cable comes in mm² only
- Dual cable comes marked with AWG and mm²

- VDE 0295-CLASS 2 is 7 strands cable
- Multi wire stranding is 19 strands cable
- VDE 0295-CLASS 5 is high stranded cable with extra flexibility

PV Cable Assemblies

| How to order | | | | | |
|-----------------------------------|--|--|--|--|---|
| Product family HC Helios cable | Product C H4 A UTX B H4-R | Gender F Female M Male P Mated pair | Connector type C Cable gland M Panel M12 N Panel M14 O Over-mold | Cable size 2 2.5mm ² /14AWG 4 4.0mm ² /12AWG 6 6.0mm ² /10AWG 8 10.0mm ² /8AWG | Approvals TO TUV 1000V D0 Dual UL600V TUV 1000V D1 Dual UL 1000V TUV 1000V U0 UL 600V U1 UL 1000V U2 UL 2000V E1 EN 1500V E2 Dual EN 1500V UL 2000V |
| Cable length(mm) | Cable color B Black-standard R Red L Blue G Grey O Brown OG Orange Y Yellow | End type PS Pre-stripped wire R Ring terminal IR Isolated ring terminal T Tube terminal IT Isolated tube terminal | Variations | | |

Examples of cable assemblies and definition of cable length:



- Other terminals and customized strip lengths are available.
- Please contact us for customer variations.

Overmolded Junctions

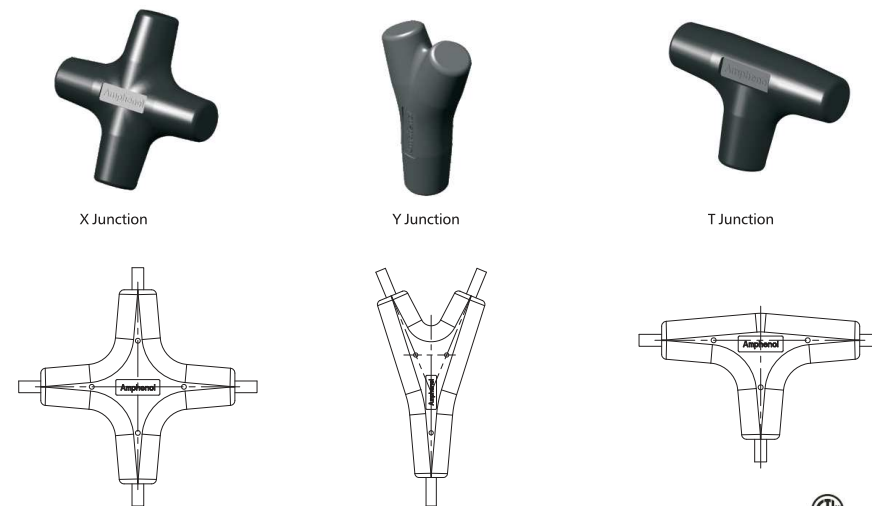

| Technical Data | |
|---------------------------|---|
| Certification | IEC 62093, UL 9703 |
| Rated current | 50A max |
| Rated voltage | 1000V DC, 1500V DC |
| Insulation material | Thermoplastic, UL94 V-0 |
| Degree of protection | IP67 |
| Cable range | 2.5mm ² /14AWG~10.0mm ² /8AWG |
| Ambient temperature range | -40°C ~ +85°C |



- Please contact us for T/X/R Junction cable assembly ordering configurations.

Hercules II PV Junction Box

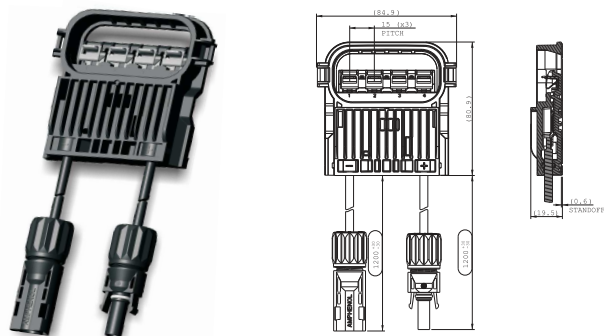

Features:

- Compact size, Pre-potting
- Good heat dissipation
- Breathing hole for pressure balance
- For automatic assembly at PV module side



How to order

| Product family | Product type | Terminals and diodes | Terminal style | Diode rating |
|----------------|----------------------------|--|---|---|
| HB Helios JB | C Hercules II Junction box | A 4 contacts/3 diodes | A Clamping contacts B Soldering contacts C Snake wiring contacts D Spot welding contacts | A Y J 25A45V B HY 25A45V C Y J 30A45V |
| Sealing type | Breathing hole | Cable size | Cable length positive (Ln)* | Cable length negative (Lp)* |
| A O-ring | Y Yes | A 4.0mm ² /12AWG Dual cable B 4.0mm ² /12AWG TUV only | A 1000mm B 1100mm C 1200mm D 800mm E 1400mm | A 1000mm B 1100mm C 1200mm D 800mm E 1400mm |

Technical Data

| | |
|-------------------|-----------------------------|
| Rated Voltage | 1000V DC(TUV), 1000V DC(UL) |
| Rated current | 10A, 13A |
| Terminal quantity | 4 rails |
| Number of diodes | 3 |
| Ribbon connection | Clamping |
| Sealing type | O-ring |
| Breathing hole | With |
| Protection degree | Ip67 |
| Safety class | II |
| Flame class | UL94 V-0, 5VB |
| Cable size | 4.0mm ² /12AWG |
| Connector type | Helios H4 |
| Temperature range | -40°C~85°C |

*Ln: Cable length on negative end

*Lp: Cable length on positive end

Hercules III 5T4D PV Junction Box

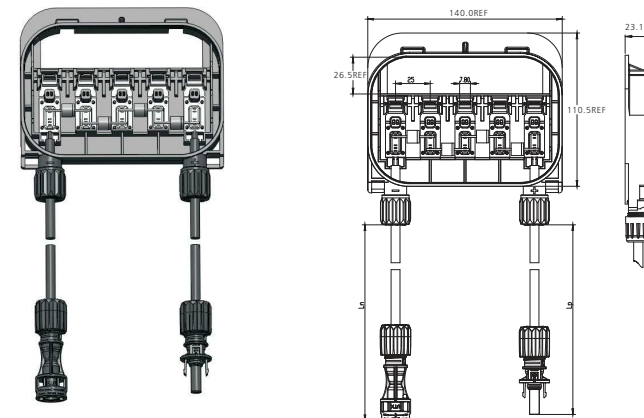

Features:

- Breathing film for pressure balance
- Wire-locking design for installation of module
- Multi-diode options



How to order

| Product family | Product type | Rated voltage | Rated current & Diode |
|--|--|----------------------------------|-----------------------|
| HB Helios JB | D Hercules 3 J-box | C TUV 1000V/UL 1000V (5T4D type) | C 11A (25PV045) |
| Cable Length | Variations | | |
| A Ln:1000mm, Lp:1000mm C Ln:1200mm, Lp:1200mm | C old version body and lid D new version body and lid | | |

Technical Data

| | |
|-------------------|-----------------------------|
| Rated Voltage | 1000V DC(TUV), 1000V DC(UL) |
| Rated current | 11A |
| Terminal quantity | 5 rails |
| Number of diodes | 4 |
| Ribbon connection | Clamping |
| Sealing type | O-ring |
| Protection degree | IP67 |
| Safety class | II |
| Flame class | UL94 V-0, 5VA |
| Cable size | 4.0mm ² /12AWG |
| Connector type | UTX connector |
| Pitch distance | 25mm |
| Ribbon width | 6.5mm Max |
| Temperature range | -40°C~+85°C |

Hercules IV PV Junction Box

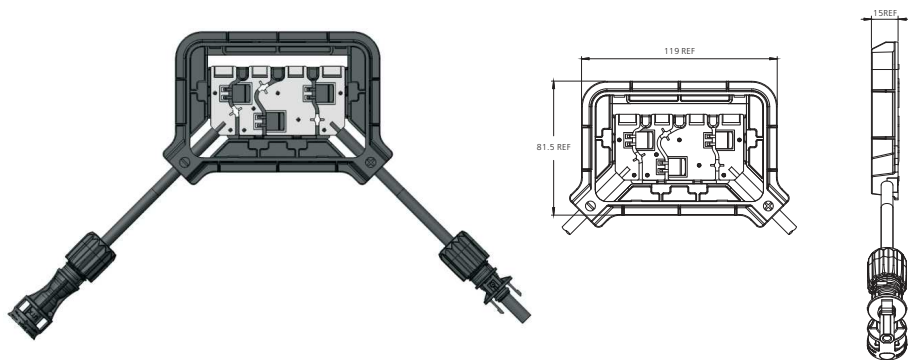

Features:

- UL 1500V/ TUV 1500V
- Variable ribbon pitch from 20–22mm
- 45° Orientation mating connectors for saving cable



| How to order | | | |
|--------------------------------|---|--|---|
| Product family HB Helios JB | Product type E Hercules IV Junction-box | Rated voltage A TUV 1500V& UL 1500V | Rated current & Diode A 15A (TP3045) |
| Copper plate A Standard | Cable Length* A Ln:1000mm, Lp:1000mm C Ln:1200mm, Lp:1200mm | Variations A Various | |

| Technical Data | |
|-------------------|-----------------------------|
| Rated voltage | 1500V DC(TUV), 1500V DC(UL) |
| Rated current | 15A |
| Terminal quantity | 4 rails |
| Number of diodes | 3 |
| Ribbon connection | Spot Welding or Soldering |
| Sealing type | Potting |
| Protection degree | IP67 |
| Safety class | II |
| Flame class | UL94 V-0, 5VA |
| Cable size | 4.0mm ² /12AWG |
| Pitch distance | 20–22mm |
| Ribbon width | 8mm Max |
| Temperature range | -40°C~+85°C |

*Ln: Cable length on negative end
*Lp: Cable length on positive end
- Please contact us for additional variations

Thin-film PV Junction Box

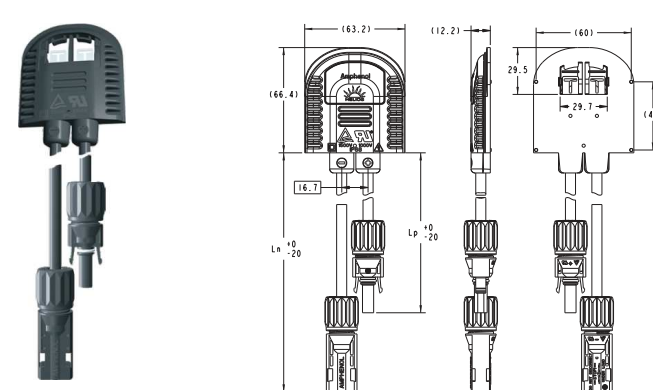

Features:

- Low profile
- Over-molded design for better sealing
- SMD for efficient heat dissipation



| How to order | | | | | | |
|--|--|--|--|---|---------------------------|------------------------|
| Product family HB Helios JB | Product type T Thin film junction box | Terminals and diodes G 2 contacts/1 diode | Terminal style B Soldering contacts | Diode rating G 5A1000V H 10A1000V J 8A1000V K 20A1200V N Without diode | Sealing type A Potting | Breathing hole N No |
| Cable size C 2.5 mm ² /14AWG | Adhesive Y Yes N No | Cable length positive (Ln)* A 1000mm B 900mm | Cable length negative (Lp)* A 1000mm B 900mm | Variations U with UTX connector N no connector | | |

| Technical Data | |
|-----------------------|--|
| Rated voltage | 1500V DC(TUV), 1000V DC(UL) |
| Rated current | Up to 20A (without diode), 4A (with diode) |
| Termination type | Soldering |
| Protection degree | IP 68 |
| Operation temperature | -40° C --- +90° C |
| Sealing type | Potting |
| Flame class | UL94 5V |
| Diode quantity option | None/ 1 |

* Ln:cable length on negative end; Lp:cable length on positive end
- Please contact us for additional variations

Herclues Triple Pole PV Junction Box



Features:

- 3 sets on the right/middle/left of backside panel
- Potting sealing
- Bifacial module's better choice

| How to order | | | | | | |
|----------------|----------------------------|--|--|--|---|--|
| Product family | Product type | Diode rated current | Gender | Cable length | Variations | |
| HB Helios JB | N Triple pole Junction box | A VSB 1545 B YJ15SQ045 C Diotec 1540 D HY25A45V | F Female end M Male end N Middle one | A 1000mm B 1100mm Y 00mm(middle end) | Blank H4 connector default A UTX connector | |

| Technical Data | |
|----------------------|--------------------------|
| Rated voltage | TUV1000V/UL1000V |
| Rated Current | 12A |
| Diode quantity | 3 |
| Degree of protection | IP68 (potted) |
| Flame class | UL94 V-0, 5VB |
| Safety class | II |
| Sealing type | Potting |
| Ribbon connection | Spot welding/Soldering |
| Connector Type | Helios H4 |
| Cable size | 12AWG/4.0mm ² |
| Temperature range | -40°C~+85°C |

Ordering example:

- HBNAFA Triple pole Jbox, Female end with VSB1545 diode, 1 meter cable length
- HBNA MA Triple pole Jbox, Male end with VSB1545 diode, 1 meter cable length
- HBNA NY Triple pole Jbox, Middle end with VSB1545 diode

Hercules Twin PV Junction Box

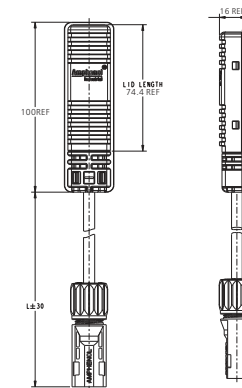

Features:

- IP 68 degree of protection
- Potting sealing
- Solution for integrated IC/diode in PV module



| How to order | | | | | |
|----------------|--|---|--------------------|---------------------------------|--------------|
| Product Family | Product type | Diode rated current | Gender | Cable length | Variations* |
| HB Helios JB | I Single pole Junction box L Double pole Junction box | A VSB 1545 B YJ15SQ045 C Diotec 1540 N without diode | F Female M Male | A 1000mm B 1100mm E 300mm | A Variations |

| Technical Data | |
|-------------------|-----------------------------|
| Rated voltage | 1000V DC(TUV), 1000V DC(UL) |
| Rated current | 12A |
| Diode quantity | 1 |
| Protection degree | IP68 (Potted) |
| Flame class | UL94 V-0, 5VB |
| Safety class | II |
| Sealing type | Potting |
| Ribbon connection | Spot welding/Soldering |
| Connector type | Helios H4 |
| Cable size | 4.0mm ² /12AWG |
| Temperature range | -40°C~+85°C |

*Please contact us for additional variations

Tool Kit. P/N: H4TK0000

Water proof with foam insert and assembly tool.



Crimping Tool



Strip Tool

| Order number | Designation | Crimp range | | Suitable for | | | |
|--------------|---------------|---------------------|---------------|--------------|-----|-----|-----|
| | | mm ² | AWG | H4 | | UTX | |
| | | | | S&F | C&F | S&F | C&F |
| H4TS0000 | Strip Tool | 2.5; 4.0; 6.0 | 14; 12; 10 | | | | |
| H4TC0001 | Crimping Tool | 2.5; 4.0; 6.0; 10.0 | 14; 12; 10; 8 | | X | | |
| H4TC0002 | Crimping Tool | 2.5; 4.0; 6.0 | 14; 12; 10 | X | | | |
| UTXTC0001 | Crimping Tool | 2.5; 4.0; 6.0; 10.0 | 14; 12; 10; 8 | | | | X |
| UTXTC0002 | Crimping Tool | 2.5; 4.0; 6.0 | 14; 12; 10 | | | X | |
| H4TD0001 | Crimping Die | 2.5; 4.0; 6.0; 10.0 | 14; 12; 10; 8 | | X | | |
| H4TD0002 | Crimping Die | 2.5; 4.0; 6.0 | 14; 12; 10 | X | | X | |
| UTXTD0001 | Crimping Die | 2.5; 4.0; 6.0; 10.0 | 14; 12; 10; 8 | | | | X |

New Crimping Tool



| Order number | Designation | Crimp range | | Suitable for | | | |
|--------------|----------------|-----------------|------------|--------------|-----|-----|-----|
| | | mm ² | AWG | H4 | | UTX | |
| | | | | S&F | C&F | S&F | C&F |
| H4TC0003 | Crimping Tool | 2.5; 4.0; 6.0 | 14; 12; 10 | X | | | |
| UTXTC0003 | Crimping Tool | 2.5; 4.0; 6.0 | 14; 12; 10 | | | X | |
| UTXTC0004 | Crimping Tool | 4.0; 6.0; 10.0 | 12; 10; 8 | | X | | X |
| UTXTC0005 | Crimping Tool | 2.5; 4.0&6.0 | 14; 12&10 | | X | | X |
| UTXTD0003 | Crimping Die | 2.5; 4.0; 6.0 | 14; 12; 10 | X | | X | |
| H4TP0002 | Locator | 2.5; 4.0; 6.0 | 14; 12; 10 | X | | | |
| UTXTP0002 | Locator | 2.5; 4.0; 6.0 | 14; 12; 10 | | | X | |
| UTXTD0005 | Crimping Die | 4.0; 6.0; 10.0 | 12; 10; 8 | | X | | X |
| UTXTP0004 | Double-Locator | 4.0; 6.0; 10.0 | 12; 10; 8 | | X | | X |
| UTXTD0004 | Crimping Die | 2.5; 4.0&6.0 | 14; 12&10 | | X | | X |
| UTXTP0003 | Double-Locator | 2.5; 4.0&6.0 | 14; 12&10 | | X | | X |



UTXTD0003



H4TP0002



UTXTP0002



UTXTD0005



UTXTP0004



UTXTD0004



UTXTP0003

Tools & Accessories

Wrench Tool for H4 Connector
P/N: H4TW0001

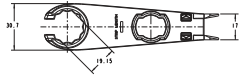

Wrench Tool for Enlarge H4 Connector
P/N: H4TW0004

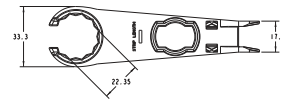

Wrench Tool for H4-R Connector
P/N: H4TW0003

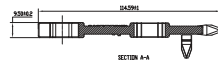

Wrench Tool for UTX Connector
P/N: UTXTWA001



Wrench Tool for UTX-XL Connector
P/N: UTXTWL001



Tools & Accessories

Universal Unlock Tool
P/N: H4TU0000

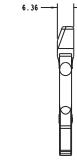
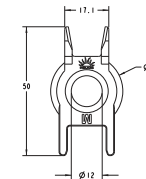

Sealing Cap for Female Connector
P/N: UTXPF

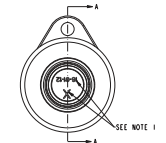
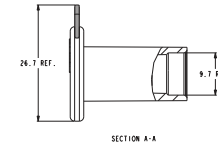

Sealing Cap for Male Connector
P/N: UTXPM

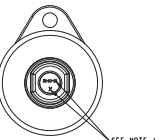
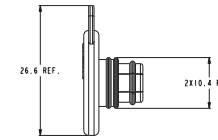

Inspection Tool for H4 Connector
P/N: H4TT0001

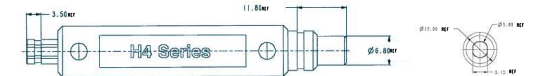

Inspection Tool for UTX Connector
P/N: UTXTT0001

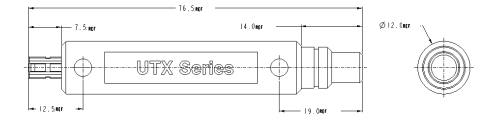

Tools & Accessories

Bulkhead wrench tool:
P/N for M12:H4TM1200; P/N for M14:H4TM1400

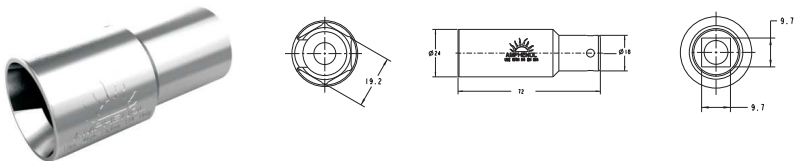

Enlarge cable connector torch wrench
P/N: H4TTW400

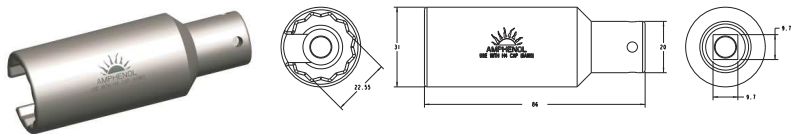

Torch wrench:P/N: H4TTW100

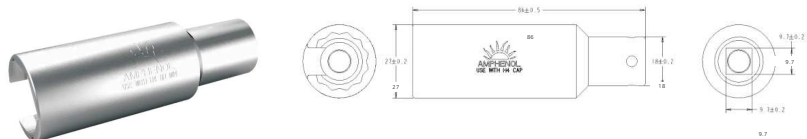

Connector hold tool:P/N: H4TH0000

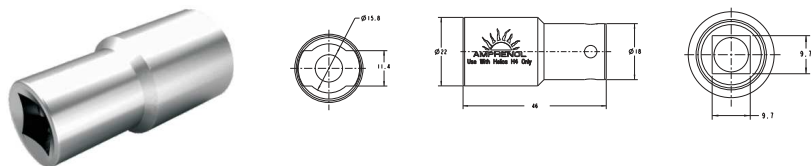

A

Amphenol product quality commitment

Amphenol Industrial Solar Technologies company emphasize innovation in product design and business relationships. By improving customer relationships, product innovation, and manufacturing technology, we strengthen our overall quality and maintain the highest standard of excellence in all aspects of products and service to our customers.

Customer Satisfaction
Team Work
Innovation & Improvement





We Not Only Connect Equipment,
We Connect People!

Компания «Океан Электроники» предлагает заключение долгосрочных отношений при поставках импортных электронных компонентов на взаимовыгодных условиях!

Наши преимущества:

- Поставка оригинальных импортных электронных компонентов напрямую с производств Америки, Европы и Азии, а так же с крупнейших складов мира;
- Широкая линейка поставок активных и пассивных импортных электронных компонентов (более 30 млн. наименований);
- Поставка сложных, дефицитных, либо снятых с производства позиций;
- Оперативные сроки поставки под заказ (от 5 рабочих дней);
- Экспресс доставка в любую точку России;
- Помощь Конструкторского Отдела и консультации квалифицированных инженеров;
- Техническая поддержка проекта, помощь в подборе аналогов, поставка прототипов;
- Поставка электронных компонентов под контролем ВП;
- Система менеджмента качества сертифицирована по Международному стандарту ISO 9001;
- При необходимости вся продукция военного и аэрокосмического назначения проходит испытания и сертификацию в лаборатории (по согласованию с заказчиком);
- Поставка специализированных компонентов военного и аэрокосмического уровня качества (Xilinx, Altera, Analog Devices, Intersil, Interpoint, Microsemi, Actel, Aeroflex, Peregrine, VPT, Syfer, Eurofarad, Texas Instruments, MS Kennedy, Miteq, Cobham, E2V, MA-COM, Hittite, Mini-Circuits, General Dynamics и др.);

Компания «Океан Электроники» является официальным дистрибьютором и эксклюзивным представителем в России одного из крупнейших производителей разъемов военного и аэрокосмического назначения «**JONHON**», а так же официальным дистрибьютором и эксклюзивным представителем в России производителя высокотехнологичных и надежных решений для передачи СВЧ сигналов «**FORSTAR**».



JONHON

«**JONHON**» (основан в 1970 г.)

Разъемы специального, военного и аэрокосмического назначения:

(Применяются в военной, авиационной, аэрокосмической, морской, железнодорожной, горно- и нефтедобывающей отраслях промышленности)

«**FORSTAR**» (основан в 1998 г.)

ВЧ соединители, коаксиальные кабели, кабельные сборки и микроволновые компоненты:

(Применяются в телекоммуникациях гражданского и специального назначения, в средствах связи, РЛС, а так же военной, авиационной и аэрокосмической отраслях промышленности).



Телефон: 8 (812) 309-75-97 (многоканальный)

Факс: 8 (812) 320-03-32

Электронная почта: ocean@oceanchips.ru

Web: <http://oceanchips.ru/>

Адрес: 198099, г. Санкт-Петербург, ул. Калинина, д. 2, корп. 4, лит. А