



RoHS compliant

FEATURES

- Handles low level load 100 μ A at 3 VDC to 100 mA 30 VDC
[Minimum switching capacity (reference value) 10 μ A at 1 VDC]
- Ultra-long stroke. For pin plunger type, it maintains an ultra-long stroke O.T. (Over Travel) with over 2.2 mm on the NO side and over 2.5 mm on the NC side.
- Since contact pressure does not depend on the operation stroke, the range of possible use over the entire stroke is greatly increased.
- Silent operation

TYPICAL APPLICATIONS

- Household appliances
(Cover detection of air conditioners and air purifiers for safety purpose. Cover destruction detection of crime prevention devices.)

ORDERING INFORMATION

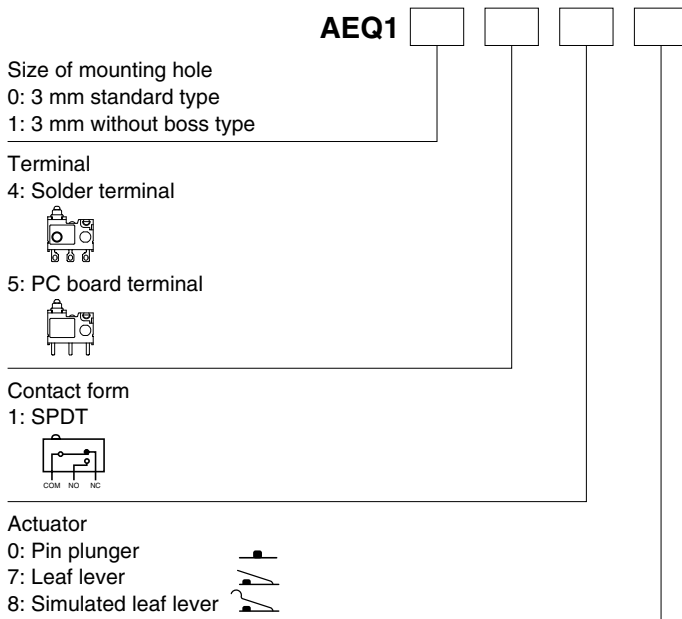

PRODUCT TYPES

Terminal type (Mounting hole: 3mm standard type / 3mm without boss type)

Actuator	Operating force Max.	Mounting hole: 3mm standard type		Mounting hole: 3mm without boss type	
		Solder terminal		PC board terminal	
Pin plunger	1.2N	AEQ10410		AEQ11510	
Leaf lever	1.7N	AEQ10417		AEQ11517	
Simulated leaf lever	1.5N	AEQ10418		AEQ11518	

AEQ1

RATING

1. Rating

100 μ A at 3 VDC to 100 mA 30 VDC.

[Min. switching capacity (Reference value*) 10 μ A at 1 VDC]

* This value is a rough indication of the lowest possible low level load at which switching is possible.

This value can change due to the switching frequency, environmental conditions, and desired reliability level, therefore it is recommended to check this with the actual load.

2. Operation environment and conditions

Item	Specifications
Ambient and storage temperature	-25°C to +85°C (no freezing and condensing)
Allowable operating speed	30 to 500 mm/sec.
Max. operating cycle rate	120 cpm

Note 1: When switching at low and high speeds or under vibration, or in high-temperature, high-humidity environments, life and performance may be reduced significantly depending on the load capacity. Please consult us.

Note 2:

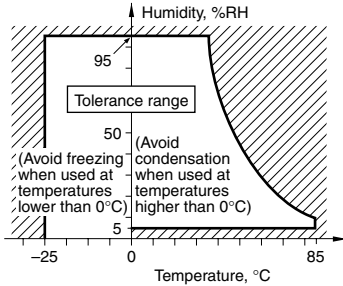

3. Electrical characteristics

Breakdown voltage (Initial)	Between non-continuous terminals: 600 Vrms, Between each terminal and other exposed metal parts: 1,500 Vrms, Between each terminal and ground: 1,500 Vrms (at detection current of 1 mA)
Insulation resistance (Initial)	Min. 100 M Ω (at 500 V DC insulation resistance meter, Locations measured same as breakdown voltage.)
Contact resistance (Initial)	Max. 1 Ω (by voltage drop 0.1 A, 6 to 8 V DC)

4. Characteristics

Item	Specifications
Electrical switching life	3 V DC 0.1 mA (resistive load) Min. 2×10^5 Switching frequency: 20 times/min. Conduction ratio: 1:1
	30 V DC 100 mA (resistive load) Min. 10^5 Pushbutton operation speed: 100 mm/s Pushbutton switching position: free position (F.P.) to total travel position (T.T.P.)
Vibration resistance (malfunction vibration resistance)	Single amplitude: 0.75 mm Amplitude of vibration: 10 to 55 Hz (4 minutes cycle) Direction and time: 2 hours each in X, Y and Z directions
Shock resistance (malfunction shock resistance)	Shock value: 294 m/s ² Direction and time: 3 times each in X, Y and Z directions
Vibration resistance endurance	Frequency of vibration: 33.3 Hz, Acceleration: 43.1 m/s ² Direction and time: 8 hours each in X, Y and Z directions
Terminal strength	Min. 6 N (to each direction, applied power at 1 minute) *Terminal deformation possible.
Salt spray resistance	Density of salt water: 5 % Temperature: 35°C each 100 hours At free position (F.P.) and total travel position (T.T.P.)
Heat and cold resistance	-45 to -40°C 48 hours 85 to 90°C 48 hours
Humidity resistance	40°C 95% R.H. 96 hours
Protection grade	IP40

Notes: As long as there are no particular designations, the following conditions apply to the test environment.

Ambient temperature: 5 to 35°C
Relative humidity: 25 to 85% R.H.
Air pressure: 86 to 106 kPa

5. Operating characteristics

Item	Standard value			
	Pin plunger	Leaf lever	Simulated leaf lever	
Operating Force (max. O.F.) *Note 2	1.2 N	1.7 N	1.5 N	
Total travel Force (max. T.F.) reference value	(1.8 N)	(3.1 N)	(2.8 N)	
Free Position (max. F.P.)	From mounting boss and hole center line	9.2 mm	14.4 mm	
Operating Position on NC side [O.P. (N.C.)] *Note 3	From mounting boss and hole center line	8.7±0.3 mm	9.8±0.5 mm	12.5±0.5 mm
Operating Position on NO side [O.P. (N.O.)] *Note 4	From mounting boss and hole center line	8.4±0.3 mm	9.3±0.5 mm	12.0±0.5 mm
Release Position on NC side [R.P. (N.C.)] *Note 6	From mounting boss and hole center line	8.8±0.3 mm	10.1±0.5 mm	12.9±0.5 mm
Release Position on NO side [R.P. (N.O.)] *Note 7	From mounting boss and hole center line	8.5±0.3 mm	9.6±0.5 mm	12.4±0.5 mm
Over travel on NC side [min. O.T. (N.C.)]		2.5 mm	3.1 mm	3.3 mm
Over travel on NO side [min. O.T. (N.O.)]		2.2 mm	2.6 mm	2.8 mm
Total Travel Position (T.T.P.) reference value	From mounting boss and hole center line	(5.9 mm)	(6.2 mm)	(8.7 mm)

- Notes: 1. The above indicates the characteristics when operating the pushbutton from the vertical direction.
 2. Indicates operation load for NO contact to achieve ON status.
 3. Indicates position for NC contact to achieve OFF status.
 4. Indicates position for NO contact to achieve ON status.
 5. Although there is some overlap in the range of the operating position (O.P.) on the NC and NO sides due to the tolerance, in actuality there is always an intermediate OFF range (the NC and NO sides will never ON at the same time.)
 6. Indicates position for NC contact to achieve ON status.
 7. Indicates position for NO contact to achieve OFF status.

OPERATION CONCEPT DIAGRAM

Contact form: terminal type

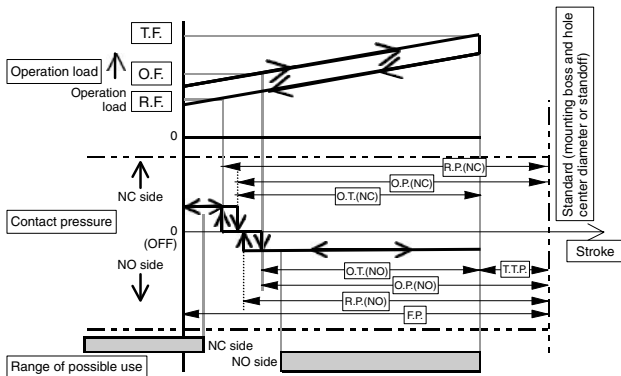

DATA

Applicable current range (reference)

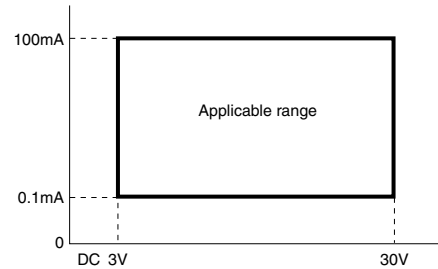

CONTACT ARRANGEMENT

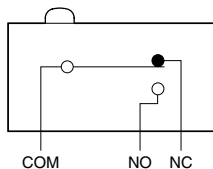

AEQ1

DIMENSIONS (Unit: mm)

The CAD data of the products with a **CAD Data** mark can be downloaded from: <http://industrial.panasonic.com/ac/e>

1. Solder terminal; Mounting hole: 3mm, standard type

Pin plunger

CAD Data



External dimensions

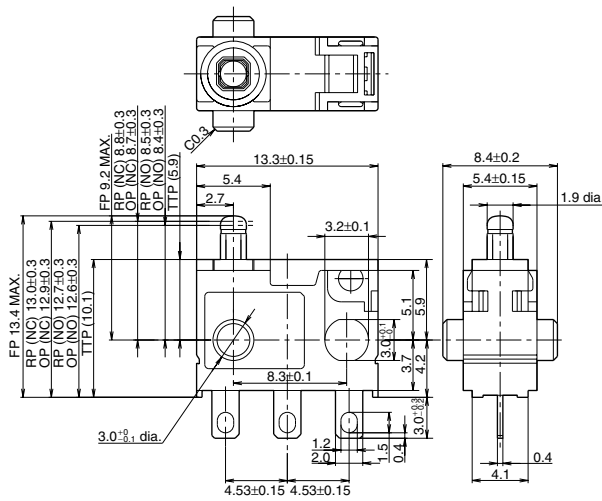

Operating Force (max. O.F.)	1.2 N	
Total travel Force (max. T.F.) reference value	(1.8 N)	
Free Position (F.P.)	From mounting boss and hole center line	9.2 mm max.
Operating Position on NC side [O.P. (N.C.)]	From mounting boss and hole center line	8.7±0.3 mm
Operating Position on NO side [O.P. (N.O.)]	From mounting boss and hole center line	8.4±0.3 mm
Release Position on NC side [R.P. (N.C.)]	From mounting boss and hole center line	8.8±0.3 mm
Release Position on NO side [R.P. (N.O.)]	From mounting boss and hole center line	8.5±0.3 mm
Over travel on NC side [min. O.T. (N.C.)]	2.5 mm	
Over travel on NO side [min. O.T. (N.O.)]	2.2 mm	

2. Leaf lever

CAD Data

External dimensions

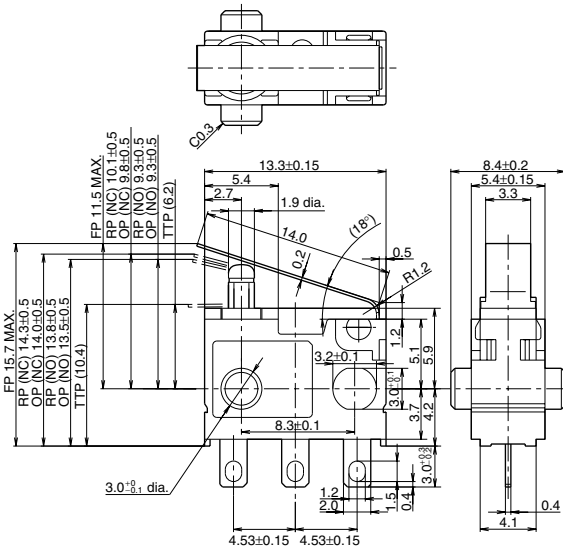

Operating Force (max. O.F.)	1.7 N	
Total travel Force (max. T.F.) reference value	(3.1 N)	
Free Position (F.P.)	From mounting boss and hole center line	11.5 mm max.
Operating Position on NC side [O.P. (N.C.)]	From mounting boss and hole center line	9.8±0.5 mm
Operating Position on NO side [O.P. (N.O.)]	From mounting boss and hole center line	9.3±0.5 mm
Release Position on NC side [R.P. (N.C.)]	From mounting boss and hole center line	10.1±0.5 mm
Release Position on NO side [R.P. (N.O.)]	From mounting boss and hole center line	9.6±0.5 mm
Over travel on NC side [min. O.T. (N.C.)]	3.1 mm	
Over travel on NO side [min. O.T. (N.O.)]	2.6 mm	

Note: When switching at high speed or under shock, lever endurance may drop. Therefore, please be sure to conduct an endurance evaluation under actual switching conditions.

3. Simulated leaf lever

CAD Data

External dimensions

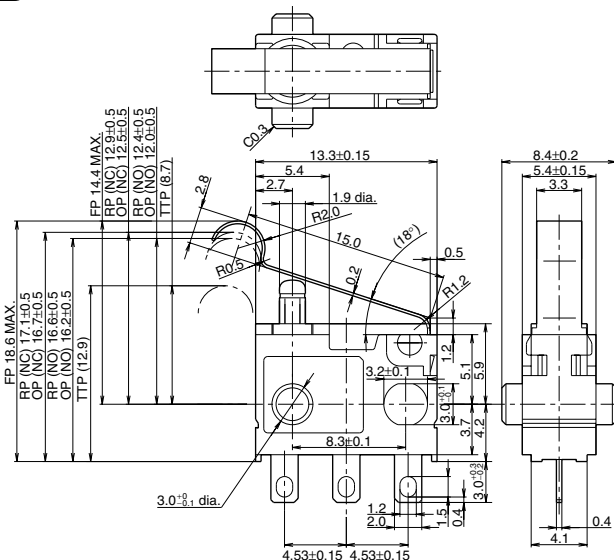

Operating Force (max. O.F.)	1.5 N	
Total travel Force (max. T.F.) reference value	(2.8 N)	
Free Position (F.P.)	From mounting boss and hole center line	14.4 mm max.
Operating Position on NC side [O.P. (N.C.)]	From mounting boss and hole center line	12.5±0.5 mm
Operating Position on NO side [O.P. (N.O.)]	From mounting boss and hole center line	12.0±0.5 mm
Release Position on NC side [R.P. (N.C.)]	From mounting boss and hole center line	12.9±0.5 mm
Release Position on NO side [R.P. (N.O.)]	From mounting boss and hole center line	12.4±0.5 mm
Over travel on NC side [min. O.T. (N.C.)]	3.3 mm	
Over travel on NO side [min. O.T. (N.O.)]	2.8 mm	

Note: When switching at high speed or under shock, lever endurance may drop. Therefore, please be sure to conduct an endurance evaluation under actual switching conditions.

4. PC board terminal; Mounting hole: 3 mm, without boss type

Pin plunger

CAD Data

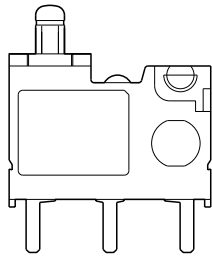

PC board terminal

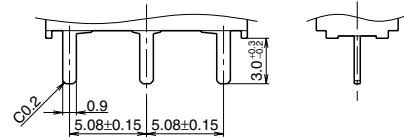

PC board pattern

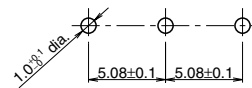

NOTES

■ **Soldering conditions**

Manual soldering: use soldering irons (max. 350°C, within 2 seconds) capable of temperature adjustment. This is to prevent deterioration due to soldering heat. Care should be taken not to apply force to the terminals during soldering. Terminal portion must not be moved within 1 minute after soldering.

■ **Mounting**

Please avoid use in which load would be applied to the sides [hatch part (both sides) shown below] of the switch in the direction indicated by the arrows. This could cause erroneous operation. Also, when using a metal installation board, please make allowance for burr direction designation and burr suppressing, etc., so that the burr side will not be on the switch installation side.

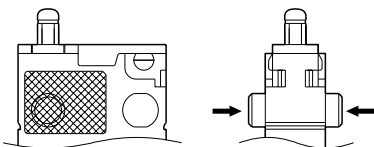

- 1) To secure the switch, please use an M3 small screw on a flat surface and tighten using a maximum torque of 0.29 N·m. It is recommended that spring washers be used with the screws and adhesive be applied to lock the screws to prevent loosening of the screws. Please make sure not to apply adhesive onto the moving parts.
- 2) Be sure to maintain adequate insulating clearance between each terminal and ground.
- 3) Although it is possible to directly operate the pin plunger type from the lateral direction, please consult us if doing so.
- 4) After mounting please make sure no tensile load will be applied to the switch terminals.

5) Range of possible use: Please set the operation position to within the ranges in the following table so that there is sufficient insulation distance and to maintain contact reliability.

Actuator	Plunger/lever free	
	From boss and hole center line	From standoff
Pin plunger	>9.2 mm	>13.4 mm
Leaf lever	>10.7 mm	>14.9 mm
Simulated leaf lever	>13.5 mm	>17.7 mm

Actuator	Plunger/Lever pushed	
	From boss and hole center line	From standoff
Pin plunger	7.8 to 5.9 mm	12.0 to 10.1 mm
Leaf lever	8.4 to 6.2 mm	12.6 to 10.4 mm
Simulated leaf lever	11.1 to 8.7 mm	15.3 to 12.9 mm

6) PC board terminal type should be used if the products are to be soldered on the PC board. (Solder terminal type is not for soldering on PC board.)

■ **Cautions regarding the circuit**

- 1) In order to prevent malfunction in set devices caused by bounce and chattering during the ON-OFF switch operation, please verify the validity of the circuit under actual operating conditions and temperature range.
- 2) When switching inductive loads (relays, solenoids, buzzers, etc.), an arc absorbing circuit is recommended to protect the contacts.

■ **Please verify under actual conditions.**

Please be sure to conduct quality verification under actual operating conditions in order to increase reliability during actual use.

■ **Switch selection**

Please make your selection so that there will be no problems even if the operating characteristics vary up to ±20% from the standard values.

■ **Other**

- 1) Keep away from environments where silicon based adhesives, oil or grease are present as faulty contacts may result from silicon oxide. Do not use in areas where flammable or explosive gases from gasoline and thinner, etc., may be present.
- 2) When using the lever type, please be careful not to apply unreasonable load from the reverse or lateral directions of operation.
- 3) Do not exceed the total travel position (TTP) and press the actuator. This could cause operation failure. Also, when switching at high speed or under shock even within the operation limit, the working life may decrease. Therefore, please be sure to verify the quality under actual conditions of use.
- 4) Please make considerations so that the switch does not become the stopper for the operating part. The switch could break.

Mouser Electronics

Authorized Distributor

Click to View Pricing, Inventory, Delivery & Lifecycle Information:

Panasonic:

[AEQ10410](#) [AEQ10417](#) [AEQ10418](#) [AEQ11510](#) [AEQ11517](#) [AEQ11518](#)

Компания «Океан Электроники» предлагает заключение долгосрочных отношений при поставках импортных электронных компонентов на взаимовыгодных условиях!

Наши преимущества:

- Поставка оригинальных импортных электронных компонентов напрямую с производств Америки, Европы и Азии, а так же с крупнейших складов мира;
- Широкая линейка поставок активных и пассивных импортных электронных компонентов (более 30 млн. наименований);
- Поставка сложных, дефицитных, либо снятых с производства позиций;
- Оперативные сроки поставки под заказ (от 5 рабочих дней);
- Экспресс доставка в любую точку России;
- Помощь Конструкторского Отдела и консультации квалифицированных инженеров;
- Техническая поддержка проекта, помощь в подборе аналогов, поставка прототипов;
- Поставка электронных компонентов под контролем ВП;
- Система менеджмента качества сертифицирована по Международному стандарту ISO 9001;
- При необходимости вся продукция военного и аэрокосмического назначения проходит испытания и сертификацию в лаборатории (по согласованию с заказчиком);
- Поставка специализированных компонентов военного и аэрокосмического уровня качества (Xilinx, Altera, Analog Devices, Intersil, Interpoint, Microsemi, Actel, Aeroflex, Peregrine, VPT, Syfer, Eurofarad, Texas Instruments, MS Kennedy, Miteq, Cobham, E2V, MA-COM, Hittite, Mini-Circuits, General Dynamics и др.);

Компания «Океан Электроники» является официальным дистрибьютором и эксклюзивным представителем в России одного из крупнейших производителей разъемов военного и аэрокосмического назначения «JONHON», а так же официальным дистрибьютором и эксклюзивным представителем в России производителя высокотехнологичных и надежных решений для передачи СВЧ сигналов «FORSTAR».



JONHON

«JONHON» (основан в 1970 г.)

Разъемы специального, военного и аэрокосмического назначения:

(Применяются в военной, авиационной, аэрокосмической, морской, железнодорожной, горно- и нефтедобывающей отраслях промышленности)

«FORSTAR» (основан в 1998 г.)

ВЧ соединители, коаксиальные кабели, кабельные сборки и микроволновые компоненты:

(Применяются в телекоммуникациях гражданского и специального назначения, в средствах связи, РЛС, а так же военной, авиационной и аэрокосмической отраслях промышленности).



Телефон: 8 (812) 309-75-97 (многоканальный)

Факс: 8 (812) 320-03-32

Электронная почта: ocean@oceanchips.ru

Web: <http://oceanchips.ru/>

Адрес: 198099, г. Санкт-Петербург, ул. Калинина, д. 2, корп. 4, лит. А