

# PCMFxUSB3S series

## Common-mode EMI filter for differential channels with integrated ESD protection

Rev. 3 — 7 March 2019

Product data sheet

## 1. General description

Common-mode ElectroMagnetic Interference (EMI) filters with integrated ElectroStatic Discharge (ESD) protection for one, two and three differential channels. The devices are designed to provide low insertion loss for differential high-speed signals on each channel while unwanted common-mode signals are attenuated.

Each differential channel incorporates two signal lines that are coupled by integrated coils. Diodes provide protection to downstream components from ESD voltages up to  $\pm 15$  kV on each signal line.

**Table 1. Product overview**

| Type number | Number of channels | Package Name |
|-------------|--------------------|--------------|
| PCMF1USB3S  | 1                  | WLCSP5       |
| PCMF2USB3S  | 2                  | WLCSP10      |
| PCMF3USB3S  | 3                  | WLCSP15      |

## 2. Features and benefits

- One, two and three differential channels common-mode EMI filters with integrated ESD protection
- ESD protection up to  $\pm 15$  kV contact discharge according to IEC 61000-4-2
- Superior common-mode suppression over a wide frequency range
- Superior RF performance compared to other integrated filters or discrete filters with external ESD protection
- Extremely high symmetry between line pairs
- Industry-standard Wafer-Level Chip-Scale Packages: WLCSP5, 10 and 15 for smaller footprint

## 3. Applications

- Smartphone, cellular and cordless phone
- Tablet PC and Mobile Internet Device (MID)
- USB 3.2, USB 2.0, HDMI 2.0, HDMI 1.4
- MIPI M-PHY and D-PHY as used in Camera Serial Interface (CSI) and Display Serial Interface (DSI)
- General-purpose EMI and Radio-Frequency Interference (RFI) filter and downstream ESD protection

### 4. Pinning information

Table 2. Pinning

| Pin                               | Symbol   | Description          | Simplified outline                                   | Graphic symbol  |
|-----------------------------------|----------|----------------------|--|---|
| <b>PCMF1USB3S (WLCSP5_2-1-2)</b>  |          |                      |  |   |
| A1                                | CH1_IN+  | channel 1+, external | <p>Transparent top view<br/><b>WLCSP5_2-1-2</b></p>  | <p>aaa-019784</p>   |
| A2                                | CH1_IN-  | channel 1-, external |  |   |
| B1                                | GND_CH1  | ground channel 1     |  |   |
| C1                                | CH1_OUT+ | channel 1+, internal |  |   |
| C2                                | CH1_OUT- | channel 1-, internal |  |   |
| <b>PCMF2USB3S (WLCSP10_4-2-4)</b> |          |                      |  |   |
| A1                                | CH1_IN+  | channel 1+, external | <p>Transparent top view<br/><b>WLCSP10_4-2-4</b></p> | <p>B1, B2 - no internal connection<br/>aaa-019785</p>     |
| A2                                | CH1_IN-  | channel 1-, external |  |   |
| A3                                | CH2_IN+  | channel 2+, external |  |   |
| A4                                | CH2_IN-  | channel 2-, external |  |   |
| B1                                | GND_CH1  | ground channel 1     |  |   |
| B2                                | GND_CH2  | ground channel 2     |  |   |
| C1                                | CH1_OUT+ | channel 1+, internal |  |   |
| C2                                | CH1_OUT- | channel 1-, internal |  |   |
| C3                                | CH2_OUT+ | channel 2+, internal |  |   |
| C4                                | CH2_OUT- | channel 2-, internal |  |   |
| <b>PCMF3USB3S (WLCSP15_6-3-6)</b> |          |                      |  |   |
| A1                                | CH1_IN+  | channel 1+, external | <p>Transparent top view<br/><b>WLCSP15_6-3-6</b></p> | <p>B1, B2, B3 - no internal connection<br/>aaa-019786</p> |
| A2                                | CH1_IN-  | channel 1-, external |  |   |
| A3                                | CH2_IN+  | channel 2+, external |  |   |
| A4                                | CH2_IN-  | channel 2-, external |  |   |
| A5                                | CH3_IN+  | channel 3+, external |  |   |
| A6                                | CH3_IN-  | channel 3-, external |  |   |
| B1                                | GND_CH1  | ground channel 1     |  |   |
| B2                                | GND_CH2  | ground channel 2     |  |   |
| B3                                | GND_CH3  | ground channel 3     |  |   |
| C1                                | CH1_OUT+ | channel 1+, internal |  |   |
| C2                                | CH1_OUT- | channel 1-, internal |  |   |
| C3                                | CH2_OUT+ | channel 2+, internal |  |   |
| C4                                | CH2_OUT- | channel 2-, internal |  |   |
| C5                                | CH3_OUT+ | channel 3+, internal |  |   |
| C6                                | CH3_OUT- | channel 3-, internal |  |   |

## 5. Ordering information

Table 3. Ordering information

| Type number | Package |   |
|-------------|---------|---|
|             | Name    | Description                                     |
| PCMF1USB3S  | WLCSP5  | wafer level chip-size package; 5 bumps (2-1-2)  |
| PCMF2USB3S  | WLCSP10 | wafer level chip-size package; 10 bumps (4-2-4) |
| PCMF3USB3S  | WLCSP15 | wafer level chip-size package; 15 bumps (6-3-6) |

## 6. Marking

Table 4. Marking codes

| Type number | Marking code |
|-------------|--------------|
| PCMF1USB3S  | PF1S         |
| PCMF2USB3S  | PF2S         |
| PCMF3USB3S  | PF3S         |

## 7. Limiting values

Table 5. Limiting values

In accordance with the Absolute Maximum Rating System (IEC 60134).

| Symbol    | Parameter                       | Conditions  | Min  | Max | Unit |
|-----------|---------------------------------|---|------|-----|------|
| $V_I$     | input voltage                   |   | -0.5 | 5   | V    |
| $V_{ESD}$ | electrostatic discharge voltage | IEC 61000-4-2, level 4; all input pins to ground  |      |     |      |
|           |                                 | contact discharge                                 | -15  | 15  | kV   |
|           |                                 | air discharge                                     | -15  | 15  | kV   |
|           |                                 | IEC 61000-4-2, level 4; all output pins to ground |      |     |      |
|           |                                 | contact discharge                                 | -2   | 2   | kV   |
|           |                                 | air discharge                                     | -2   | 2   | kV   |
| $I_{PPM}$ | rated peak-pulse current        | $t_p = 8/20 \mu s$                                | -7   | 7   | A    |
| $T_{stg}$ | storage temperature             |   | -40  | 125 | °C   |
| $T_{amb}$ | ambient temperature             |   | -40  | 125 | °C   |

## 8. Characteristics

### 8.1. Channel characteristics

**Table 6. Channel characteristics**

$T_{amb} = 25\text{ °C}$  unless otherwise specified.

| Symbol      | Parameter                 | Conditions                                | Min | Typ  | Max | Unit     |
|-------------|---------------------------|---|-----|------|-----|----------|
| $R_{s(ch)}$ | channel series resistance | single line; input to output              | -   | 3    | -   | $\Omega$ |
| $C_d$       | diode capacitance         | $f = 1\text{ MHz}$ ; $V_I = 2.5\text{ V}$ | [1] | 0.25 | -   | pF       |
| $I_{RM}$    | reverse leakage current   | per line;<br>$V_I = 5\text{ V}$           | -   | -    | 100 | nA       |
| $V_{BR}$    | breakdown voltage         | $I_R = 1\text{ mA}$                       | 6   | 9    | -   | V        |
| $V_F$       | forward voltage           | $I_F = 10\text{ mA}$                      | -   | 0.8  | -   | V        |
| $R_{dyn}$   | dynamic resistance        | TLP; positive transient                   | [2] | 0.14 | -   | $\Omega$ |
|             |                           | TLP; negative transient                   | [2] | 0.14 | -   | $\Omega$ |
|             |                           | surge; positive transient                 | [3] | 0.22 | -   | $\Omega$ |
|             |                           | surge; negative transient                 | [3] | 0.22 | -   | $\Omega$ |

[1] This parameter is guaranteed by design.

[2] 100 ns Transmission Line Pulse (TLP); 50  $\Omega$ ; pulser at 70 ns to 90 ns.

[3] According to IEC 61000-4-5 (8/20  $\mu$ s).

### 8.2. Frequency characteristics

**Table 7. Frequency characteristics**

$T_{amb} = 25\text{ °C}$  unless otherwise specified.

| Symbol  | Parameter         | Conditions           | Min | Typ | Max | Unit |
|---|-------------------|----------------------|-----|-----|-----|------|
| <b>Common mode: <math>S_{21cc}</math></b>       |                   |                      |     |     |     |      |
| $\alpha_{il}$                                   | insertion loss    | $f = 800\text{ MHz}$ | [1] | -12 | -   | dB   |
|   |                   | $f = 2.6\text{ GHz}$ | [1] | -38 | -   | dB   |
|   |                   | $f = 5\text{ GHz}$   | [1] | -18 | -   | dB   |
| <b>Differential mode: <math>S_{21dd}</math></b> |                   |                      |     |     |     |      |
| $\alpha_{il}$                                   | insertion loss    | $f = 1\text{ MHz}$   | [1] | 0.3 | -   | dB   |
| $f_{-3dB}$                                      | cut-off frequency |                      | [1] | 6   | -   | GHz  |

[1] Normalized to attenuation at 1 MHz.

Common-mode EMI filter for differential channels with integrated ESD protection

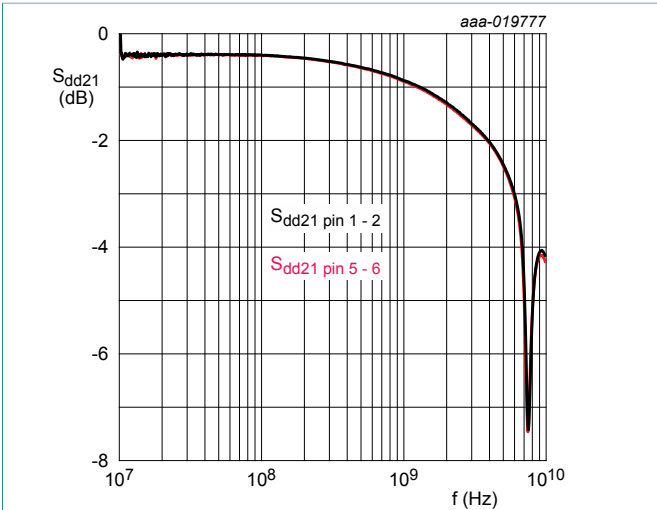

Fig. 1. Differential-mode insertion loss; typical values

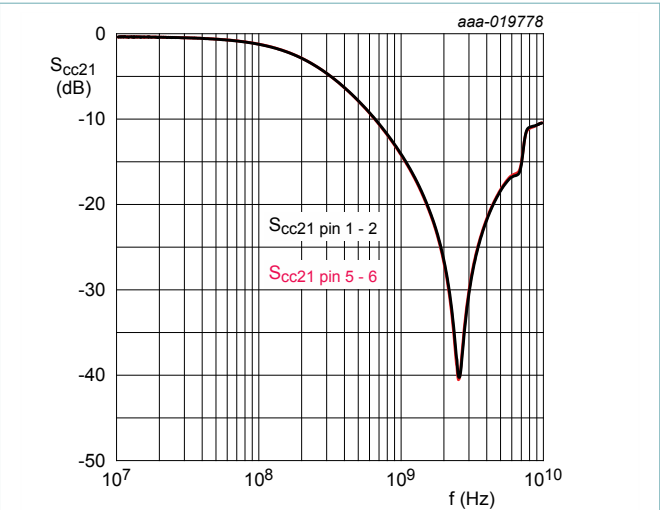
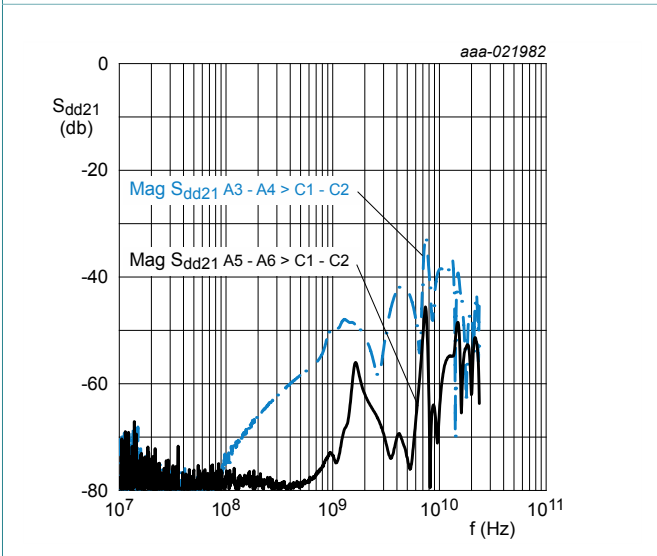
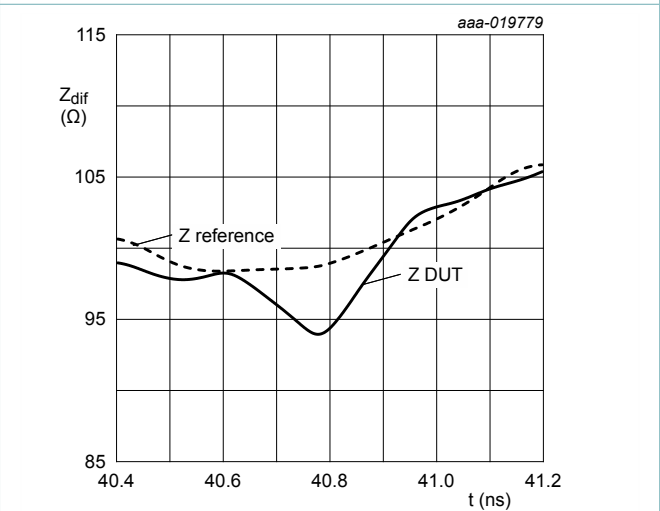

Fig. 2. Common-mode insertion loss; typical values



CH1 to CH2

Fig. 3. Differential crosstalk; typical values



$t_r = 200$  ps

Fig. 4. Differential Time Domain Reflectometer (TDR) plot; typical values

Common-mode EMI filter for differential channels with integrated ESD protection

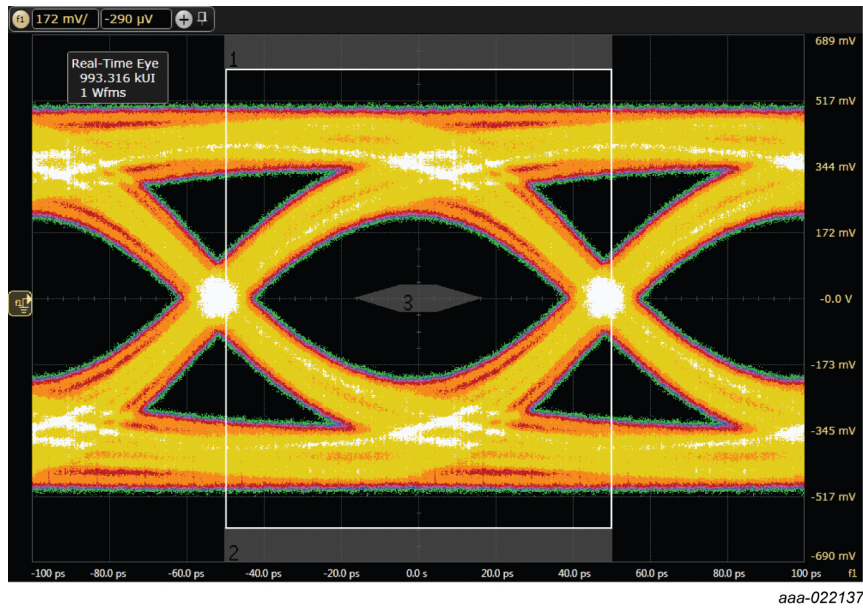

Data rate: 10 Gbit/s  
 Vertical scale 172 mV/div  
 Horizontal scale: 20 ps/div

Fig. 5. USB 3.2 eye diagram 10 Gbps, test board with PCMF2USB3S; typical values

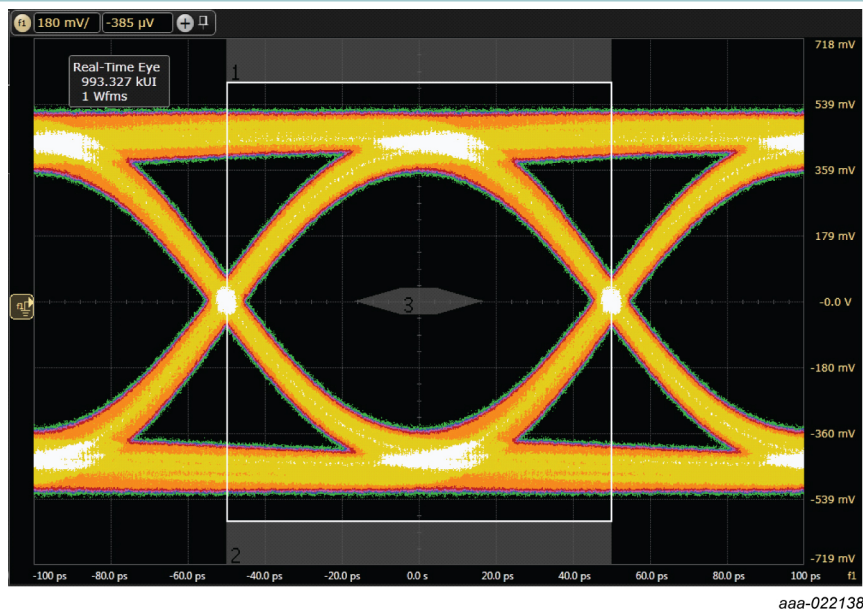

Data rate: 10 Gbit/s  
 Vertical scale 180 mV/div  
 Horizontal scale: 20 ps/div

Fig. 6. USB 3.2 eye diagram 10 Gbps, test board without device; typical values

Common-mode EMI filter for differential channels with integrated ESD protection

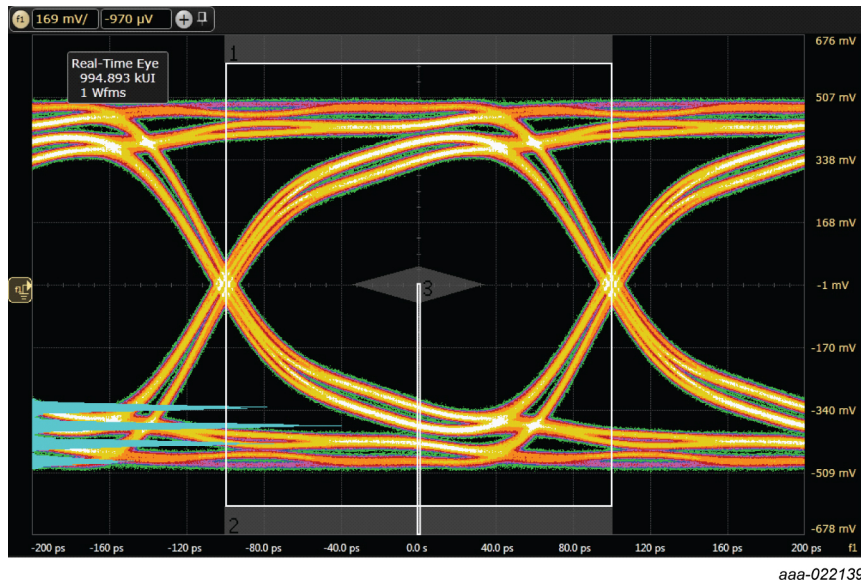

Data rate: 5 Gbit/s  
 Vertical scale 169 mV/div  
 Horizontal scale: 40 ps/div

Fig. 7. USB 3.2 eye diagram 5 Gbps, test board with PCMF2USB3S; typical values

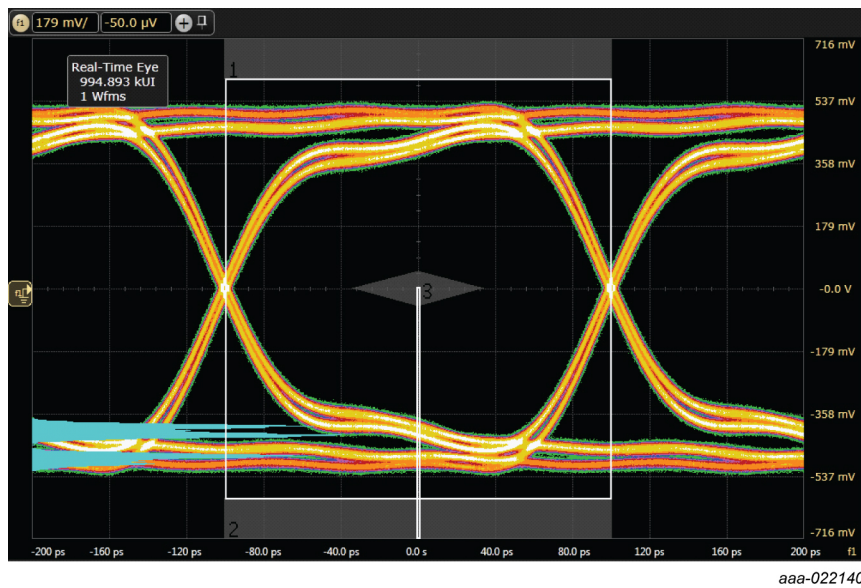

Data rate: 5 Gbit/s  
 Vertical scale 179 mV/div  
 Horizontal scale: 40 ps/div

Fig. 8. USB 3.2 eye diagram 5 Gbps, test board without device; typical values

Common-mode EMI filter for differential channels with integrated ESD protection

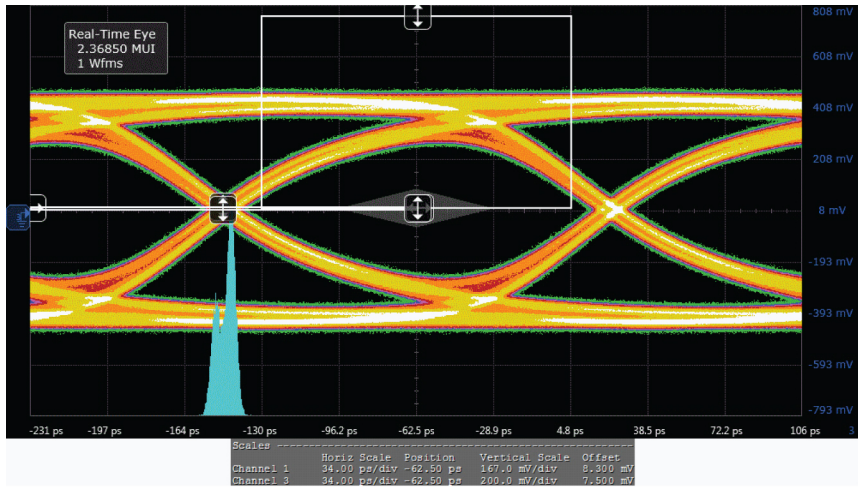

aaa-022141

Test frequency: 148.5 MHz  
 Differential swing voltage: 861 mV  
 Horizontal scale: 34 ps/div

Fig. 9. HDMI 2.0 eye diagram TP1, test board with PCMF2USB3S; typical values

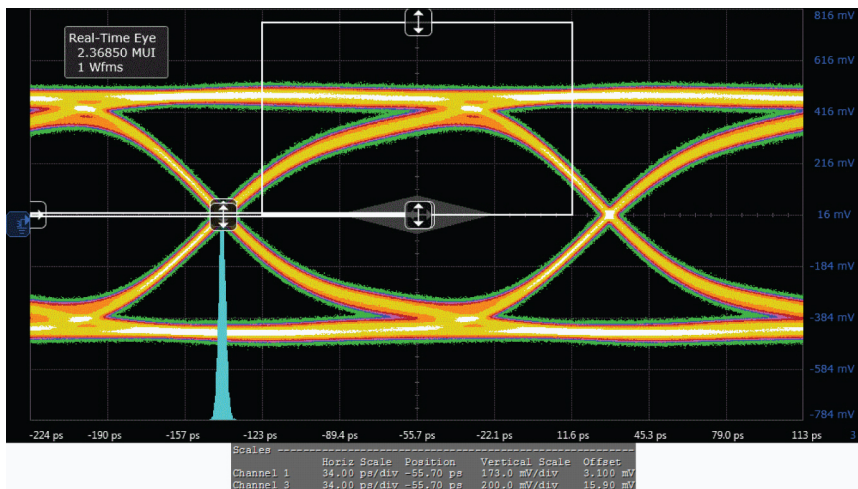

aaa-022142

Test frequency: 148.5 MHz  
 Differential swing voltage: 917 mV  
 Horizontal scale: 34 ps/div

Fig. 10. HDMI 2.0 eye diagram TP1, test board without device; typical values



Common-mode EMI filter for differential channels with integrated ESD protection

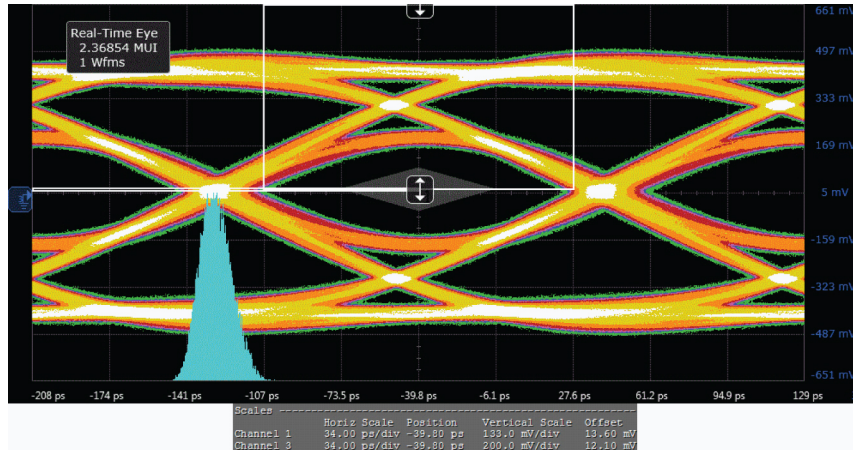

aaa-022143

Test frequency: 148.5 MHz

Differential swing voltage: 849 mV

Horizontal scale: 34 ps/div

**Remark:** Measured at Test Point 2 (TP2) worst cable emulator, reference cable equalizer and worst case positive skew.

Fig. 11. HDMI 2.0 eye diagram TP2, test board with PCMF2USB3S; typical values

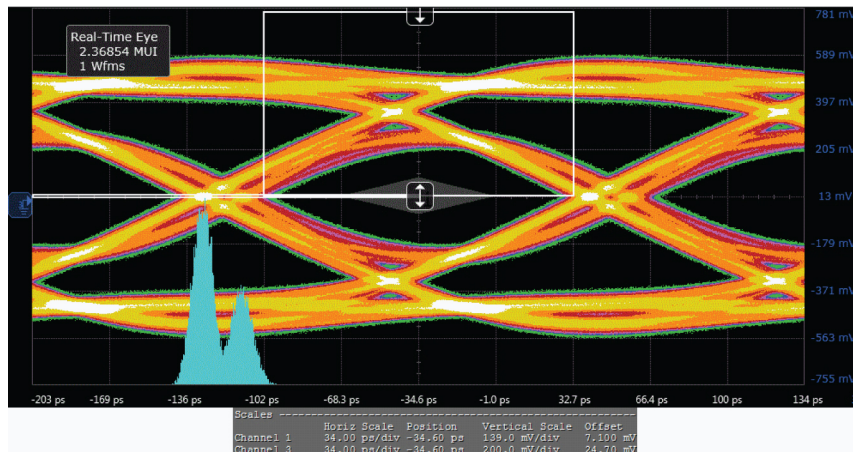

aaa-022144

Test frequency: 148.5 MHz

Differential swing voltage: 909 mV

Horizontal scale: 34 ps/div

**Remark:** Measured at Test Point 2 (TP2) worst cable emulator, reference cable equalizer and worst case positive skew.

Fig. 12. HDMI 2.0 eye diagram TP2, test board without device; typical values

Common-mode EMI filter for differential channels with integrated ESD protection

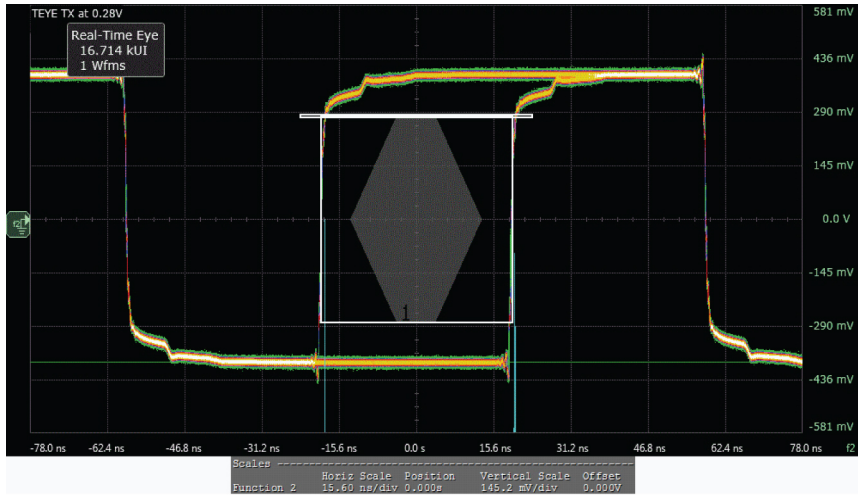

aaa-022146

Vertical scale: 145 mV/div  
 Horizontal scale: 15.6 ns/div

Fig. 13. MIPI M-PHY PWM-TX transmitter eye opening at 140 mV, test board with PCMF2USB3S; typical value

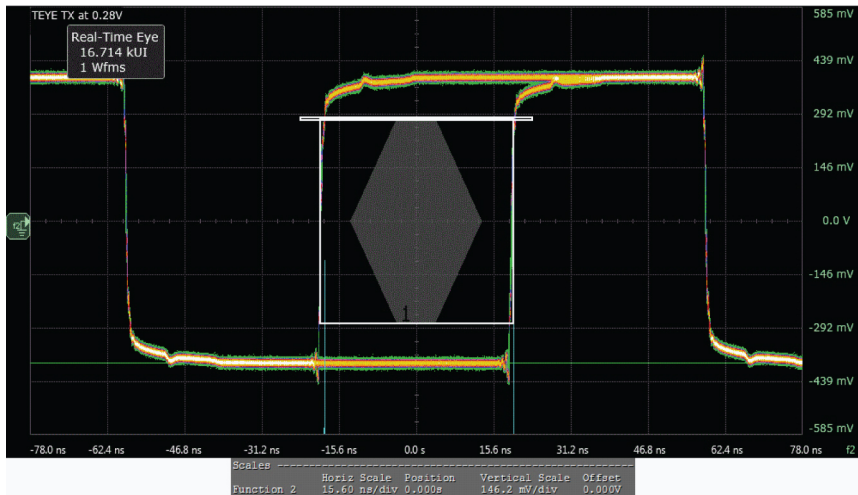

aaa-022148

Vertical scale: 146 mV/div  
 Horizontal scale: 15.6 ns/div

Fig. 14. MIPI M-PHY PWM-TX transmitter eye opening at 140 mV, test board without device; typical value

Common-mode EMI filter for differential channels with integrated ESD protection

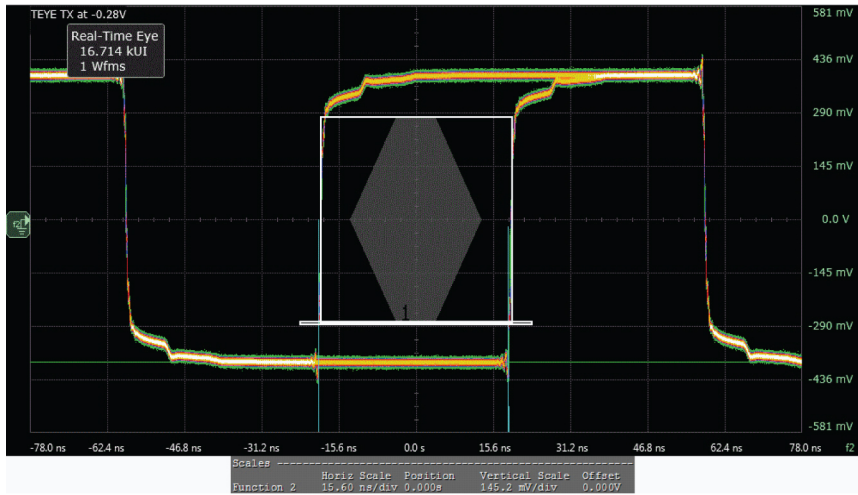

aaa-022147

Vertical scale: 145 mV/div  
Horizontal scale: 15.6 ns/div

Fig. 15. MIPI M-PHY PWM-TX transmitter eye opening at -140 mV, test board with PCMF2USB3S; typical value

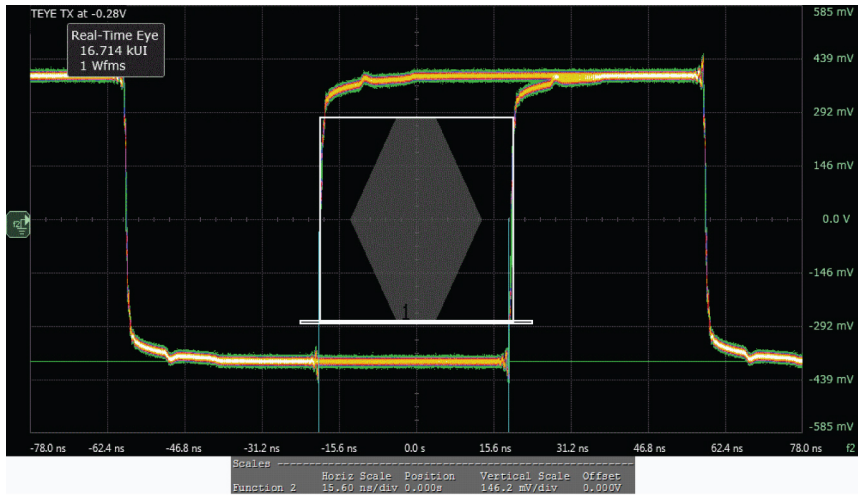

aaa-022149

Vertical scale: 145 mV/div  
Horizontal scale: 15.6 ns/div

Fig. 16. MIPI M-PHY PWM-TX transmitter eye opening at -140 mV, test board without device; typical value

Common-mode EMI filter for differential channels with integrated ESD protection

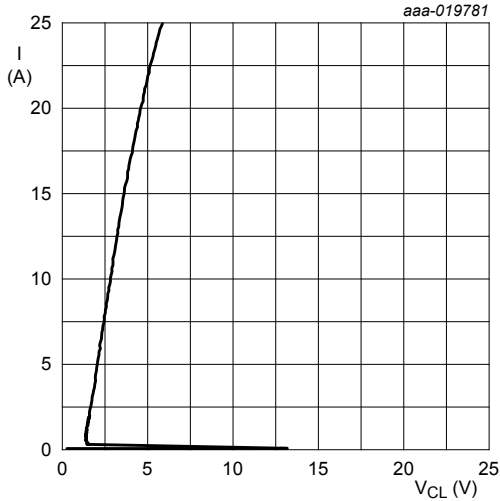

Transmission Line Pulse (TLP) = 100 ns;  
 $t_r = 1$  ns

**Fig. 17. Dynamic resistance with positive clamping; typical values**

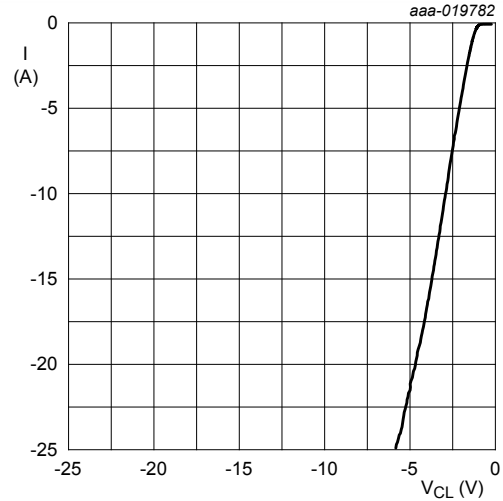

Transmission Line Pulse (TLP) = 100 ns;  
 $t_r = 1$  ns

**Fig. 18. Dynamic resistance with negative clamping; typical values**

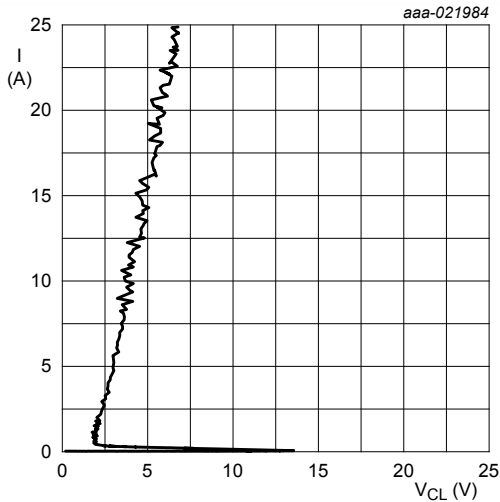

Very-Fast Transmission Line Pulse (VF-TLP) = 5 ns;  
 $t_r = 600$  ps

**Fig. 19. Dynamic resistance with positive clamping; typical values**

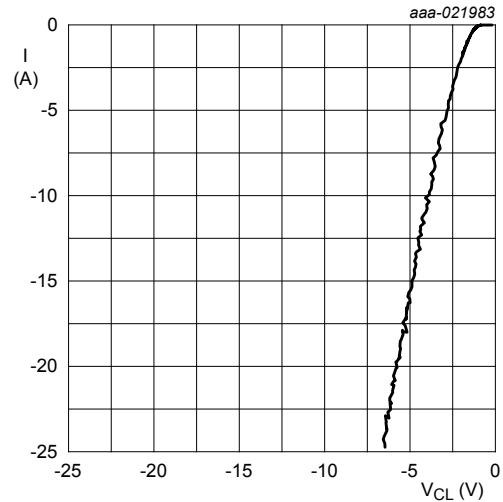

Very-Fast Transmission Line Pulse (VF-TLP) = 5 ns;  
 $t_r = 600$  ps

**Fig. 20. Dynamic resistance with negative clamping; typical values**

The device uses an advanced clamping structure showing a negative dynamic resistance. This snap-back behavior strongly reduces the clamping voltage to the system behind the ESD protection during an ESD event. Do not connect unlimited DC current sources to the data lines to avoid keeping the ESD protection device in snap-back state after exceeding breakdown voltage (due to an ESD pulse for instance).

Common-mode EMI filter for differential channels with integrated ESD protection

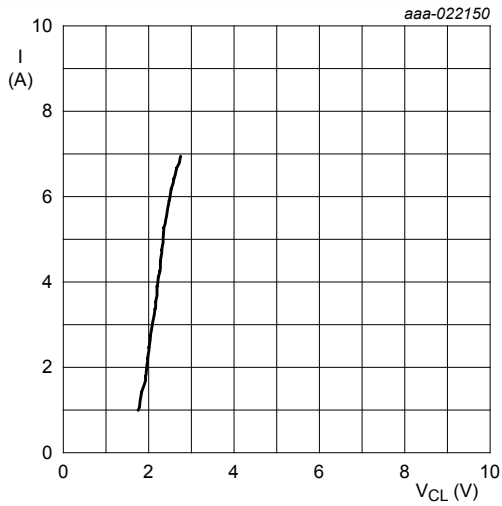

IEC61000-4-5;  $t_p = 8/20 \mu s$ ; positive pulse

**Fig. 21. Dynamic resistance with positive clamping; typical values**

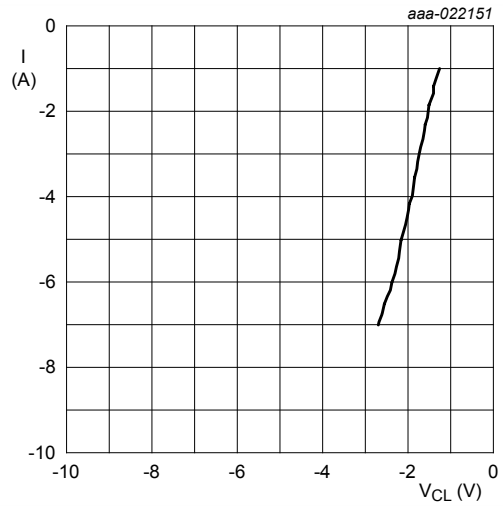

IEC61000-4-5;  $t_p = 8/20 \mu s$ ; negative pulse

**Fig. 22. Dynamic resistance with negative clamping; typical values**

## 9. Application information

The device is designed to provide high-level ESD protection for differential high-speed data line pairs such as:

- USB 3.2
- HDMI 2.0
- Transition-Minimized Differential Signaling (TMDS)
- DisplayPort
- external Serial Advanced Technology Attachment (eSATA)
- Low Voltage Differential Signaling (LVDS)

When designing the Printed-Circuit Board (PCB), give careful consideration to impedance matching and signal coupling. Do not connect the protected signal lines to unlimited current sources like, for example, a battery.

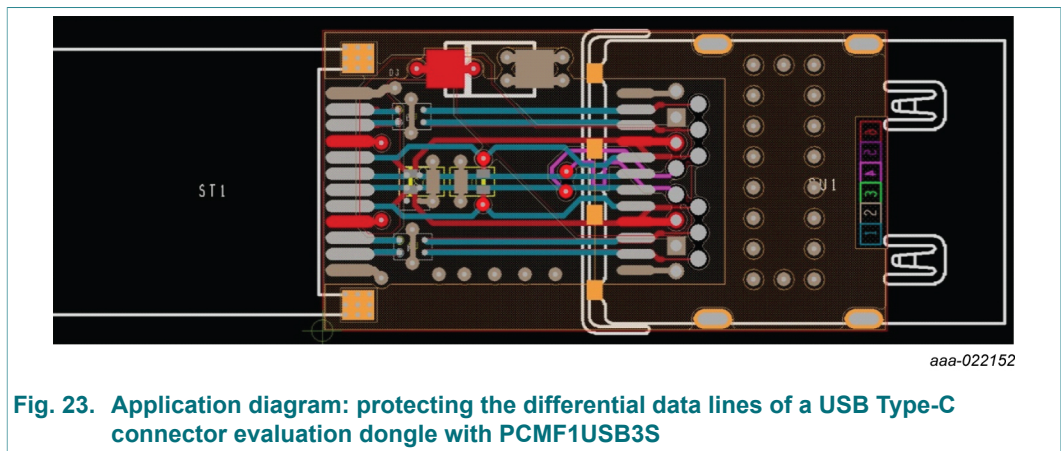

Since the SuperSpeed TX/RX lines are separated by GND or VBUS from the Hi-Speed lines, PCMF1USB3S makes it easy to achieve same signal lengths, straight routing, and optimal positioning for ESD protection directly at the connector.

### 10. Package outline

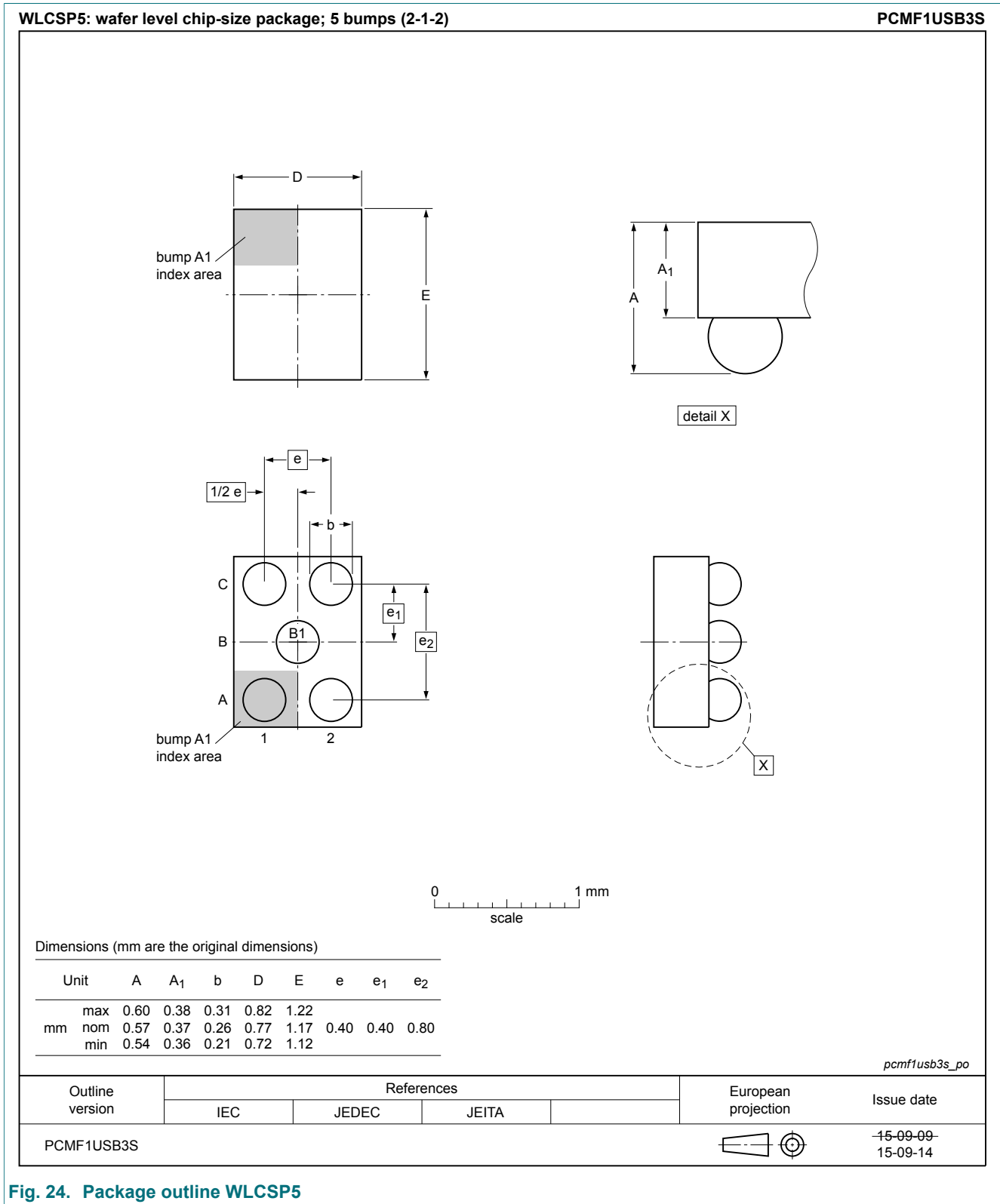

**Fig. 24. Package outline WLCSP5**

WLCSP10: wafer level chip-size package; 10 bumps (4-2-4)

PCMF2USB3S

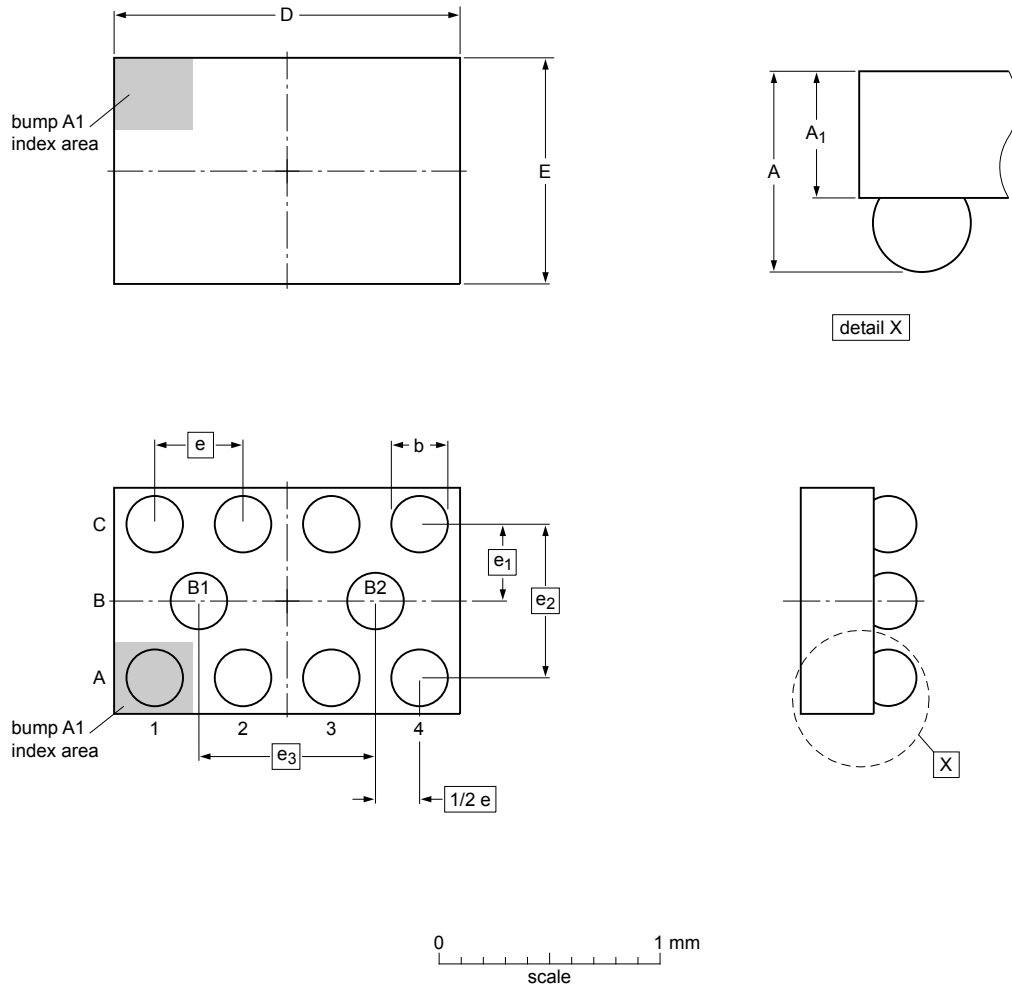

Dimensions (mm are the original dimensions)

| Unit | A        | A <sub>1</sub> | b    | D    | E    | e    | e <sub>1</sub> | e <sub>2</sub> | e <sub>3</sub> |
|------|----------|----------------|------|------|------|------|----------------|----------------|----------------|
| mm   | max 0.60 | 0.38           | 0.31 | 1.62 | 1.22 |      |                |                |                |
|      | nom 0.57 | 0.37           | 0.26 | 1.57 | 1.17 | 0.40 | 0.40           | 0.80           | 0.80           |
|      | min 0.54 | 0.36           | 0.21 | 1.52 | 1.12 |      |                |                |                |

pcmf2usb3s\_po

| Outline version | References |       |       |  | European projection | Issue date           |
|-----------------|------------|-------|-------|--|---------------------|----------------------|
|                 | IEC        | JEDEC | JEITA |  |                     |                      |
| PCMF2USB3S      |            |       |       |  |                     | 15-09-09<br>15-09-14 |

Fig. 25. Package outline WLCSP10



WLCSP15: wafer level chip-size package; 15 bumps (6-3-6)

PCMF3USB3S

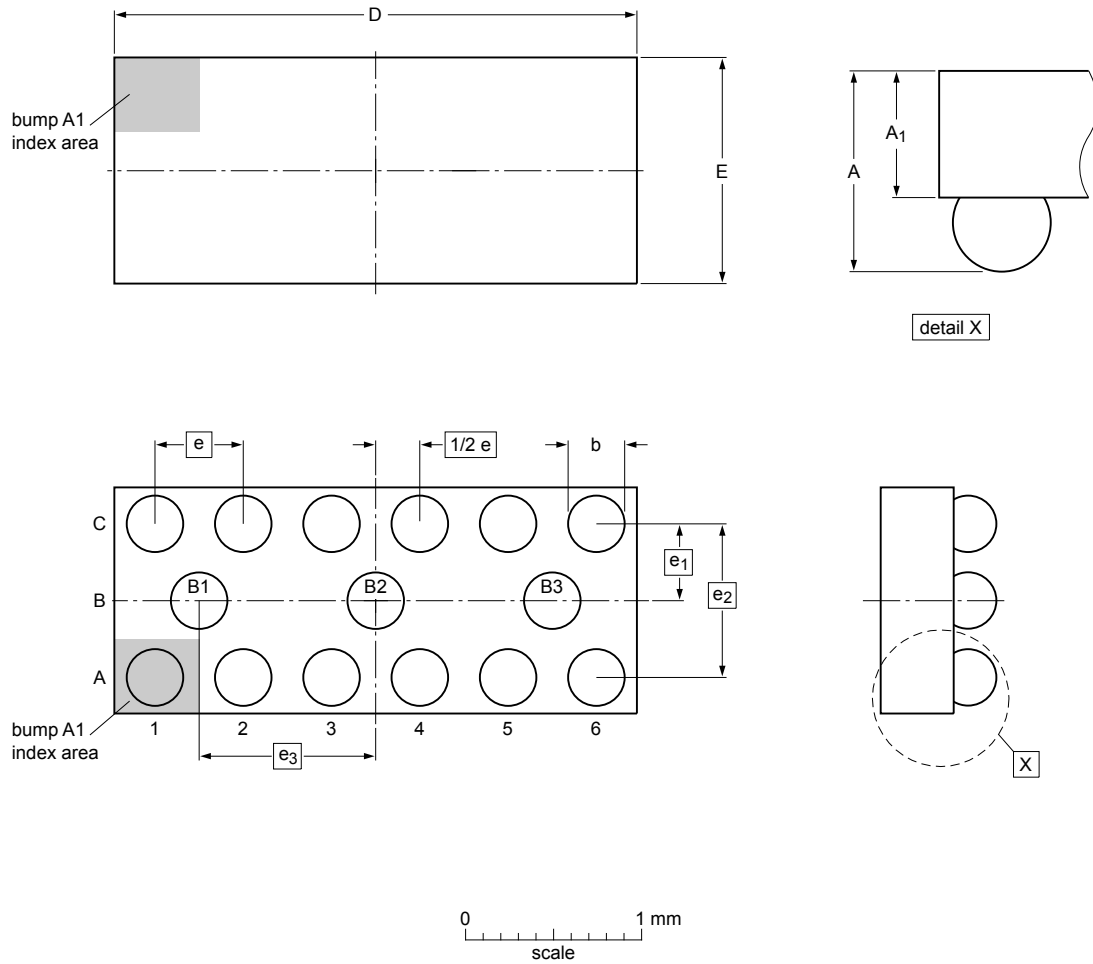

Dimensions (mm are the original dimensions)

| Unit | A        | A <sub>1</sub> | b    | D    | E    | e    | e <sub>1</sub> | e <sub>2</sub> | e <sub>3</sub> |
|------|----------|----------------|------|------|------|------|----------------|----------------|----------------|
| mm   | max 0.60 | 0.38           | 0.31 | 2.42 | 1.22 |      |                |                |                |
|      | nom 0.57 | 0.37           | 0.26 | 2.37 | 1.17 | 0.40 | 0.40           | 0.80           | 0.80           |
|      | min 0.54 | 0.36           | 0.21 | 2.32 | 1.12 |      |                |                |                |

pcmf3usb3s\_po

| Outline version | References |       |       |  | European projection | Issue date           |
|-----------------|------------|-------|-------|--|---------------------|----------------------|
|                 | IEC        | JEDEC | JEITA |  |                     |                      |
| PCMF3USB3S      |            |       |       |  |                     | 15-09-09<br>15-09-14 |

Fig. 26. Package outline WLCSP15

### 11. Soldering

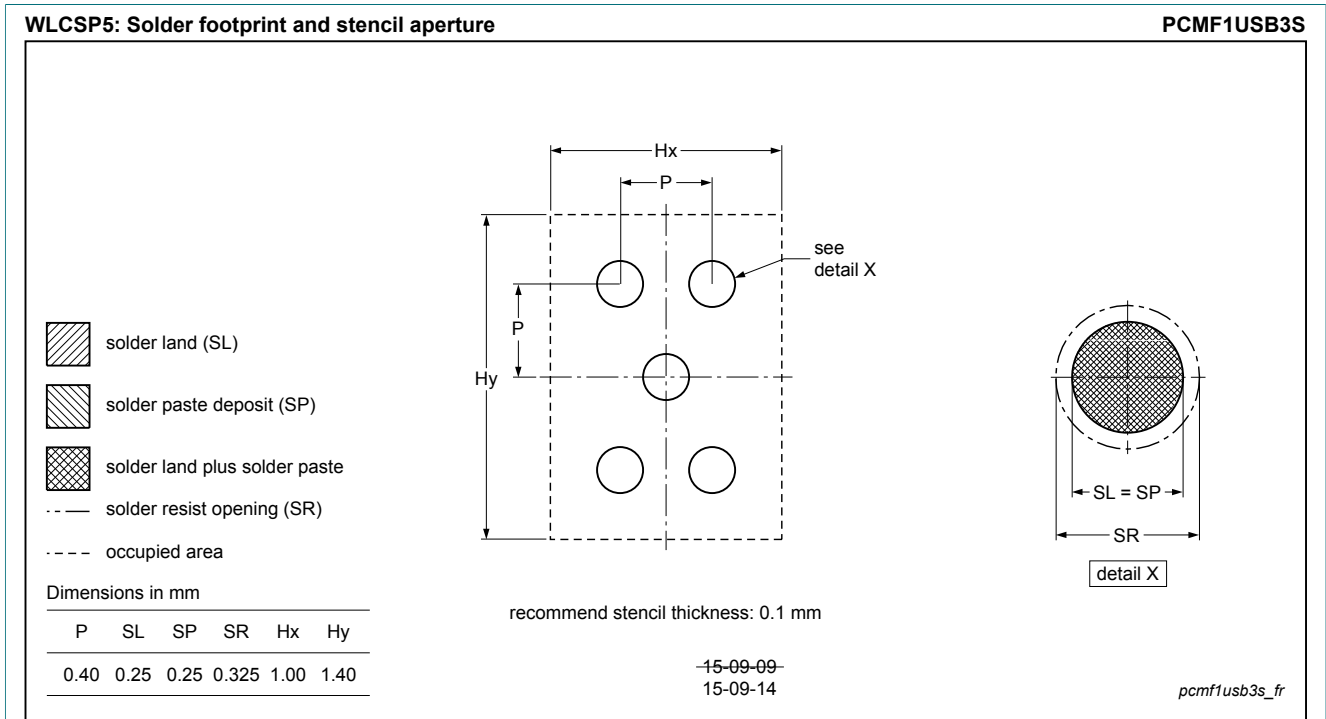

Fig. 27. Soldering footprint WLCSP5 (PCMF1USB3S)

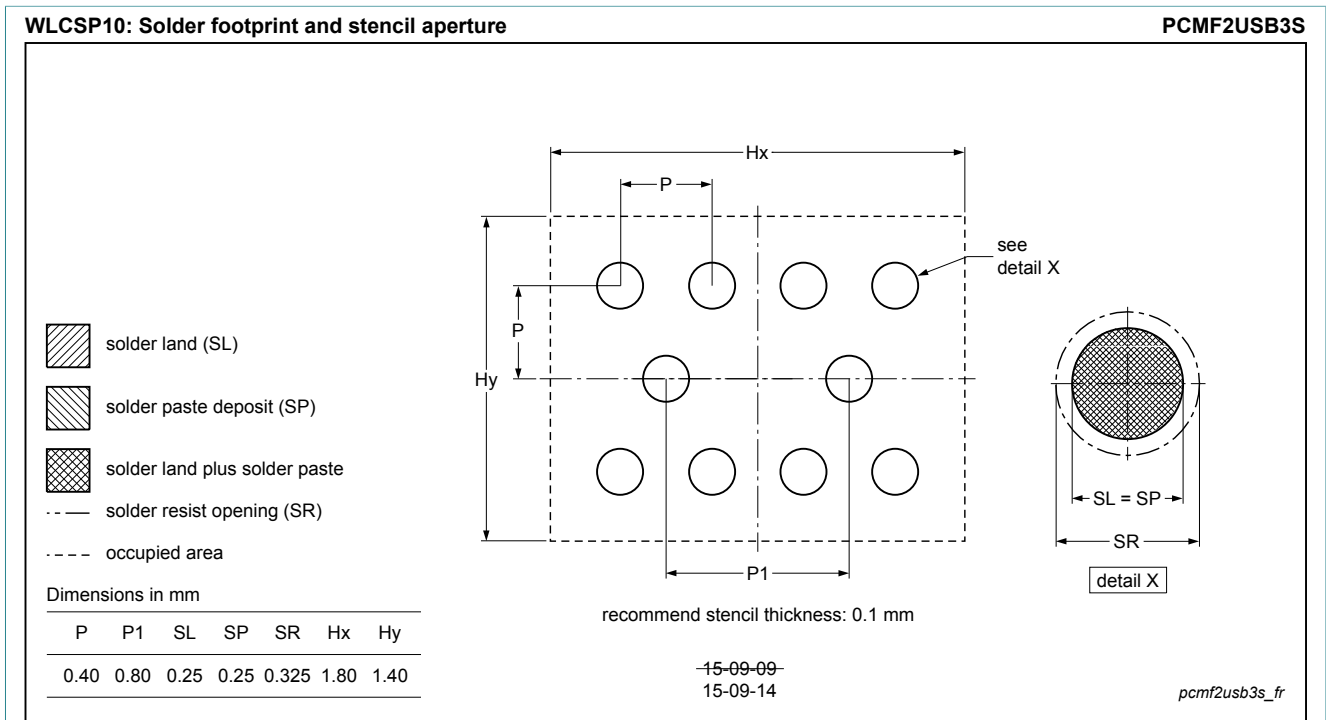
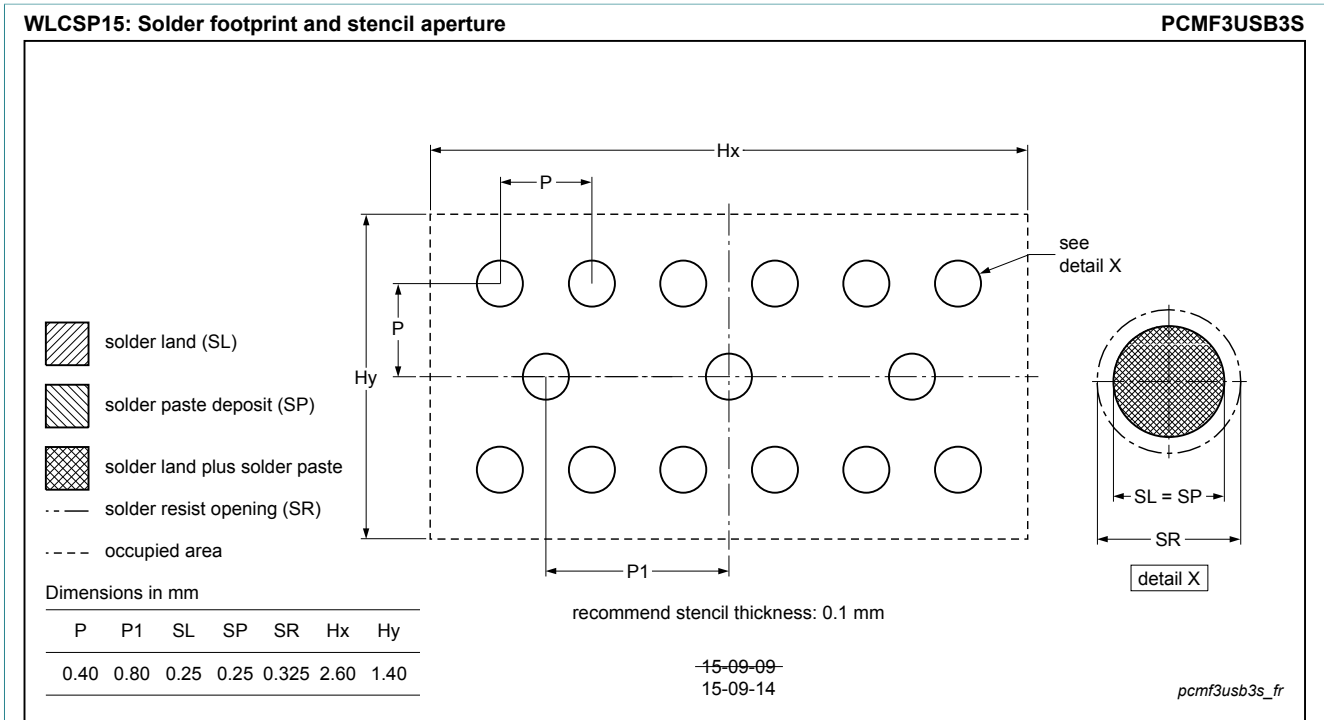

Fig. 28. Soldering footprint WLCSP10 (PCMF2USB3S)



**Fig. 29. Soldering footprint WLCSP15 (PCMF3USB3S)**

## 12. Revision history

**Table 8. Revision history**

| Data sheet ID      | Release date   | Data sheet status      | Change notice | Supersedes         |
|--------------------|--|------------------------|---------------|--------------------|
| PCMFxUSB3S_SER v.3 | 20190307   | Product data sheet     | -             | PCMFxUSB3S_SER v.2 |
| Modifications:     | <ul style="list-style-type: none"><li>Limiting values: <math>T_{amb}</math> maximum values updated.</li><li>Frequency characteristics: corrected typos in Figures 1, 2, 3 and 5.</li></ul> |                        |               |                    |
| PCMFxUSB3S_SER v.2 | 20160307   | Product data sheet     | -             | PCMFxUSB3S_SER v.1 |
| PCMFxUSB3S_SER v.1 | 20151007   | Preliminary data sheet | -             | -                  |

## 13. Legal information

### Data sheet status

| Document status [1][2]         | Product status [3] | Definition  |
|--------------------------------|--------------------|---|
| Objective [short] data sheet   | Development        | This document contains data from the objective specification for product development. |
| Preliminary [short] data sheet | Qualification      | This document contains data from the preliminary specification.                       |
| Product [short] data sheet     | Production         | This document contains the product specification.                                     |

- [1] Please consult the most recently issued document before initiating or completing a design.
- [2] The term 'short data sheet' is explained in section "Definitions".
- [3] The product status of device(s) described in this document may have changed since this document was published and may differ in case of multiple devices. The latest product status information is available on the internet at <https://www.nexperia.com>.

### Definitions

**Draft** — The document is a draft version only. The content is still under internal review and subject to formal approval, which may result in modifications or additions. Nexperia does not give any representations or warranties as to the accuracy or completeness of information included herein and shall have no liability for the consequences of use of such information.

**Short data sheet** — A short data sheet is an extract from a full data sheet with the same product type number(s) and title. A short data sheet is intended for quick reference only and should not be relied upon to contain detailed and full information. For detailed and full information see the relevant full data sheet, which is available on request via the local Nexperia sales office. In case of any inconsistency or conflict with the short data sheet, the full data sheet shall prevail.

**Product specification** — The information and data provided in a Product data sheet shall define the specification of the product as agreed between Nexperia and its customer, unless Nexperia and customer have explicitly agreed otherwise in writing. In no event however, shall an agreement be valid in which the Nexperia product is deemed to offer functions and qualities beyond those described in the Product data sheet.

### Disclaimers

**Limited warranty and liability** — Information in this document is believed to be accurate and reliable. However, Nexperia does not give any representations or warranties, expressed or implied, as to the accuracy or completeness of such information and shall have no liability for the consequences of use of such information. Nexperia takes no responsibility for the content in this document if provided by an information source outside of Nexperia.

In no event shall Nexperia be liable for any indirect, incidental, punitive, special or consequential damages (including - without limitation - lost profits, lost savings, business interruption, costs related to the removal or replacement of any products or rework charges) whether or not such damages are based on tort (including negligence), warranty, breach of contract or any other legal theory.

Notwithstanding any damages that customer might incur for any reason whatsoever, Nexperia's aggregate and cumulative liability towards customer for the products described herein shall be limited in accordance with the Terms and conditions of commercial sale of Nexperia.

**Right to make changes** — Nexperia reserves the right to make changes to information published in this document, including without limitation specifications and product descriptions, at any time and without notice. This document supersedes and replaces all information supplied prior to the publication hereof.

**Suitability for use** — Nexperia products are not designed, authorized or warranted to be suitable for use in life support, life-critical or safety-critical systems or equipment, nor in applications where failure or malfunction of an Nexperia product can reasonably be expected to result in personal

injury, death or severe property or environmental damage. Nexperia and its suppliers accept no liability for inclusion and/or use of Nexperia products in such equipment or applications and therefore such inclusion and/or use is at the customer's own risk.

**Quick reference data** — The Quick reference data is an extract of the product data given in the Limiting values and Characteristics sections of this document, and as such is not complete, exhaustive or legally binding.

**Applications** — Applications that are described herein for any of these products are for illustrative purposes only. Nexperia makes no representation or warranty that such applications will be suitable for the specified use without further testing or modification.

Customers are responsible for the design and operation of their applications and products using Nexperia products, and Nexperia accepts no liability for any assistance with applications or customer product design. It is customer's sole responsibility to determine whether the Nexperia product is suitable and fit for the customer's applications and products planned, as well as for the planned application and use of customer's third party customer(s). Customers should provide appropriate design and operating safeguards to minimize the risks associated with their applications and products.

Nexperia does not accept any liability related to any default, damage, costs or problem which is based on any weakness or default in the customer's applications or products, or the application or use by customer's third party customer(s). Customer is responsible for doing all necessary testing for the customer's applications and products using Nexperia products in order to avoid a default of the applications and the products or of the application or use by customer's third party customer(s). Nexperia does not accept any liability in this respect.

**Limiting values** — Stress above one or more limiting values (as defined in the Absolute Maximum Ratings System of IEC 60134) will cause permanent damage to the device. Limiting values are stress ratings only and (proper) operation of the device at these or any other conditions above those given in the Recommended operating conditions section (if present) or the Characteristics sections of this document is not warranted. Constant or repeated exposure to limiting values will permanently and irreversibly affect the quality and reliability of the device.

**Terms and conditions of commercial sale** — Nexperia products are sold subject to the general terms and conditions of commercial sale, as published at <http://www.nexperia.com/profile/terms>, unless otherwise agreed in a valid written individual agreement. In case an individual agreement is concluded only the terms and conditions of the respective agreement shall apply. Nexperia hereby expressly objects to applying the customer's general terms and conditions with regard to the purchase of Nexperia products by customer.

**No offer to sell or license** — Nothing in this document may be interpreted or construed as an offer to sell products that is open for acceptance or the grant, conveyance or implication of any license under any copyrights, patents or other industrial or intellectual property rights.

**Export control** — This document as well as the item(s) described herein may be subject to export control regulations. Export might require a prior authorization from competent authorities.

**Non-automotive qualified products** — Unless this data sheet expressly states that this specific Nexperia product is automotive qualified, the product is not suitable for automotive use. It is neither qualified nor tested in accordance with automotive testing or application requirements. Nexperia accepts no liability for inclusion and/or use of non-automotive qualified products in automotive equipment or applications.

In the event that customer uses the product for design-in and use in automotive applications to automotive specifications and standards, customer (a) shall use the product without Nexperia's warranty of the product for such automotive applications, use and specifications, and (b) whenever customer uses the product for automotive applications beyond Nexperia's specifications such use shall be solely at customer's own risk, and (c) customer fully indemnifies Nexperia for any liability, damages or failed product claims resulting from customer design and use of the product for automotive applications beyond Nexperia's standard warranty and Nexperia's product specifications.

**Translations** — A non-English (translated) version of a document is for reference only. The English version shall prevail in case of any discrepancy between the translated and English versions.

### Trademarks

Notice: All referenced brands, product names, service names and trademarks are the property of their respective owners.

## Contents

---

|   |           |
|---|-----------|
| <b>1. General description</b> .....     | <b>1</b>  |
| <b>2. Features and benefits</b> .....   | <b>1</b>  |
| <b>3. Applications</b> .....            | <b>1</b>  |
| <b>4. Pinning information</b> .....     | <b>2</b>  |
| <b>5. Ordering information</b> .....    | <b>3</b>  |
| <b>6. Marking</b> .....                 | <b>3</b>  |
| <b>7. Limiting values</b> .....         | <b>3</b>  |
| <b>8. Characteristics</b> .....         | <b>4</b>  |
| 8.1. Channel characteristics.....       | 4         |
| 8.2. Frequency characteristics.....     | 4         |
| <b>9. Application information</b> ..... | <b>14</b> |
| <b>10. Package outline</b> .....        | <b>15</b> |
| <b>11. Soldering</b> .....              | <b>18</b> |
| <b>12. Revision history</b> .....       | <b>20</b> |
| <b>13. Legal information</b> .....      | <b>21</b> |

---

© Nexperia B.V. 2019. All rights reserved

For more information, please visit: <http://www.nexperia.com>  
For sales office addresses, please send an email to: [salesaddresses@nexperia.com](mailto:salesaddresses@nexperia.com)  
Date of release: 7 March 2019

---

Компания «Океан Электроники» предлагает заключение долгосрочных отношений при поставках импортных электронных компонентов на взаимовыгодных условиях!

Наши преимущества:

- Поставка оригинальных импортных электронных компонентов напрямую с производств Америки, Европы и Азии, а так же с крупнейших складов мира;
- Широкая линейка поставок активных и пассивных импортных электронных компонентов (более 30 млн. наименований);
- Поставка сложных, дефицитных, либо снятых с производства позиций;
- Оперативные сроки поставки под заказ (от 5 рабочих дней);
- Экспресс доставка в любую точку России;
- Помощь Конструкторского Отдела и консультации квалифицированных инженеров;
- Техническая поддержка проекта, помощь в подборе аналогов, поставка прототипов;
- Поставка электронных компонентов под контролем ВП;
- Система менеджмента качества сертифицирована по Международному стандарту ISO 9001;
- При необходимости вся продукция военного и аэрокосмического назначения проходит испытания и сертификацию в лаборатории (по согласованию с заказчиком);
- Поставка специализированных компонентов военного и аэрокосмического уровня качества (Xilinx, Altera, Analog Devices, Intersil, Interpoint, Microsemi, Actel, Aeroflex, Peregrine, VPT, Syfer, Eurofarad, Texas Instruments, MS Kennedy, Miteq, Cobham, E2V, MA-COM, Hittite, Mini-Circuits, General Dynamics и др.);

Компания «Океан Электроники» является официальным дистрибьютором и эксклюзивным представителем в России одного из крупнейших производителей разъемов военного и аэрокосмического назначения «JONHON», а так же официальным дистрибьютором и эксклюзивным представителем в России производителя высокотехнологичных и надежных решений для передачи СВЧ сигналов «FORSTAR».



## JONHON

«JONHON» (основан в 1970 г.)

Разъемы специального, военного и аэрокосмического назначения:

(Применяются в военной, авиационной, аэрокосмической, морской, железнодорожной, горно- и нефтедобывающей отраслях промышленности)

«FORSTAR» (основан в 1998 г.)

ВЧ соединители, коаксиальные кабели, кабельные сборки и микроволновые компоненты:

(Применяются в телекоммуникациях гражданского и специального назначения, в средствах связи, РЛС, а так же военной, авиационной и аэрокосмической отраслях промышленности).



Телефон: 8 (812) 309-75-97 (многоканальный)

Факс: 8 (812) 320-03-32

Электронная почта: [ocean@oceanchips.ru](mailto:ocean@oceanchips.ru)

Web: <http://oceanchips.ru/>

Адрес: 198099, г. Санкт-Петербург, ул. Калинина, д. 2, корп. 4, лит. А