



## MIC2810

Digital Power Management IC  
2MHz, 600mA DC/DC w/Dual  
300mA/300mA Low  $V_{IN}$  LDOs

### General Description

The MIC2810 is a high performance power management IC, integrating a 2MHz DC/DC switcher with two 300mA LDOs. The MIC2810 features a *LOWQ*<sup>®</sup> mode, reducing the total current draw while in this mode to less than 30 $\mu$ A. In *LOWQ*<sup>®</sup> mode, the output noise of the DC/DC converter is 53 $\mu$ V<sub>RMS</sub>, significantly lower than other converters that use a PFM light load mode that can interfere with sensitive RF circuitry.

The MIC2810 is a  $\mu$ Cap design, operating with very small ceramic output capacitors and inductors for stability, therefore, reducing required board space and component cost. It is available with fixed output voltages in a 16-pin 3mm x 3mm MLF<sup>®</sup> leadless package.

Data sheets and support documentation can be found on Micrel's web site at: [www.micrel.com](http://www.micrel.com).

### Features

- 2MHz DC/DC converter and two LDOs
- Integrated power-on reset (OR function for all outputs)
  - Adjustable delay time
- *LOWQ*<sup>®</sup> mode
  - 30 $\mu$ A Total  $I_Q$  when in *LOWQ*<sup>®</sup> mode
- Tiny 16-pin 3mm x 3mm MLF<sup>®</sup> package
- Thermal shutdown protection
- Current limit protection

### DC/DC Converter

- 2.7V to 5.5V input voltage range
- Output current to 600mA in PWM mode
- *LOWQ*<sup>®</sup> Mode: NO NOISE light load mode
  - 53 $\mu$ V<sub>RMS</sub> Output noise in *LOWQ*<sup>®</sup> mode
- 2MHz PWM operation in normal mode

### LDOs

- LDO1
  - 1.65V to 5.5V input voltage range
  - 300mA Output current
  - Output voltage down to 0.8V
- LDO2
  - 2.7V to 5.5V input voltage range
  - 300mA Output current
  - Output voltage down to 0.8V

### Applications

- Mobile phones
- PDAs
- GPS receivers
- Digital still cameras
- Portable media players

### Typical Application

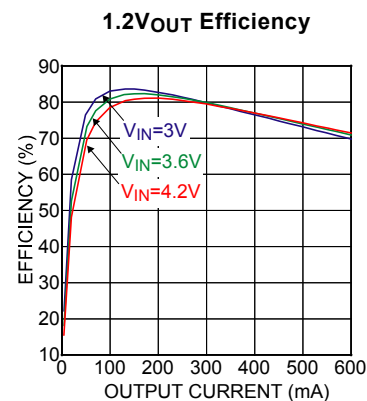
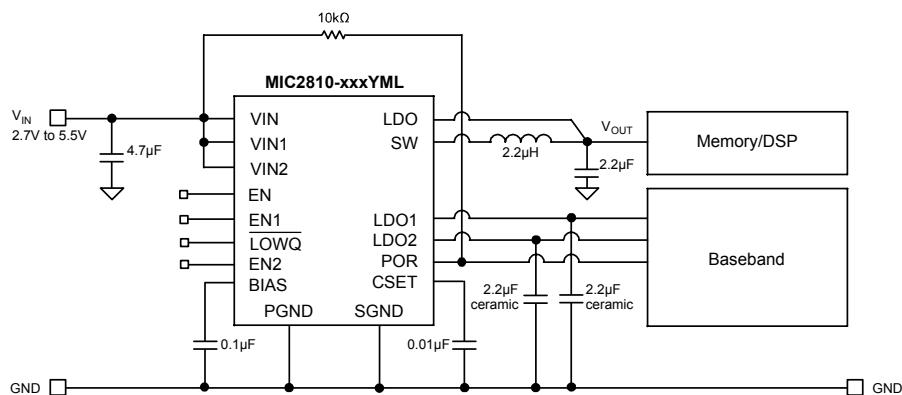

*LOWQ* is a registered trademark of Micrel, Inc.  
MLF and *MicroLeadFrame* are registered trademarks of Amkor Technology, Inc.

Micrel Inc. • 2180 Fortune Drive • San Jose, CA 95131 • USA • tel +1 (408) 944-0800 • fax + 1 (408) 474-1000 • <http://www.micrel.com>

## Ordering Information

Part Number	Marking Code	Voltage*	Junction Temperature Range	Package	Lead Finish
MIC2810-44MYML	YD44M	1.2V/1.2V/2.8V	-40°C to +125°C	16-Pin 3x3 MLF <sup>®</sup>	Pb-Free
MIC2810-4GKYML	YD4GK	1.2V/1.8V/2.6V	-40°C to +125°C	16-Pin 3x3 MLF <sup>®</sup>	Pb-Free
MIC2810-4GMYML	YD4GM	1.2V/1.8V/2.8V	-40°C to +125°C	16-Pin 3x3 MLF <sup>®</sup>	Pb-Free
MIC2810-4GPYML	YD4GP	1.2V/1.8V/3.0V	-40°C to +125°C	16-Pin 3x3 MLF <sup>®</sup>	Pb-Free
MIC2810-4GSYML	YD4GS	1.2V/1.8V/3.3V	-40°C to +125°C	16-Pin 3x3 MLF <sup>®</sup>	Pb-Free
MIC2810-4LSYML	YD4LS	1.2V/2.7V/3.3V	-40°C to +125°C	16-Pin 3x3 MLF <sup>®</sup>	Pb-Free
MIC2810-4MSYML	YD4MS	1.2V/2.8V/3.3V	-40°C to +125°C	16-Pin 3x3 MLF <sup>®</sup>	Pb-Free
MIC2810-CGJYML	YDCGJ	1.2V/1.8V/2.5V	-40°C to +125°C	16-Pin 3x3 MLF <sup>®</sup>	Pb-Free
MIC2810-FGSYML	YDFGS	1.5V/1.8V/3.3V	-40°C to +125°C	16-Pin 3x3 MLF <sup>®</sup>	Pb-Free

### Notes:

MLF<sup>®</sup> is a GREEN RoHS compliant package. Lead finish is NiPdAu. Mold compound is Halogen Free.

Other voltage options available. Please contact Micrel for details.

DC/DC – Output Voltage Range of 1.0V to 2.0V.

LDO1 – Output Voltage Range of 0.8V to 3.6V.

LDO2 – Output Voltage Range of 0.8V to 3.6V.

\* Refers to nominal output voltage of DC/DC, LDO1, and LDO2 respectively.

## Pin Configuration

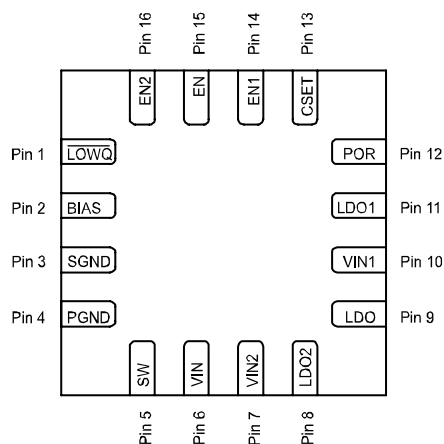

**16-Pin 3mm x 3mm MLF<sup>®</sup> (ML)**

## Pin Description

Pin Number	Pin Name	Pin Function
1	/LOWQ	LOWQ Mode. Active Low Input. Logic High = Full Power (Normal) Mode; Logic Low = LOWQ Mode; Do not leave floating.
2	BIAS	Internal circuit bias supply. It must be de-coupled to signal ground with a 0.1 $\mu$ F capacitor and should not be loaded.
3	SGND	Signal ground.
4	PGND	Power ground.
5	SW	Switch: Internal power MOSFET output switches.
6	VIN	Supply Input – DC/DC and other circuitry shared with LDO1 and LDO2. Must be connected to PIN 7.
7	VIN2	Supply Input – LDO2. Must be connected to PIN 6.
8	LDO2	Output of LDO2
9	LDO	LDO Output: Connect to $V_{OUT}$ of the DC/DC for LOWQ mode operation.
10	VIN1	Supply Input – LDO1.
11	LDO1	Output of LDO1
12	POR	Power-On Reset Output: Open-drain output. Active low indicates an output undervoltage condition on either one of the three regulated outputs.
13	CSET	Delay Set Input: Connect external capacitor to GND to set the internal delay for the POR output. When left open, there is minimum delay. This pin cannot be grounded.
14	EN1	Enable Input (LDO 1). Active High Input. Logic High = On; Logic Low = Off; Do not leave floating
15	EN	Enable Input (DC/DC). Active High Input. Logic High = On; Logic Low = Off; Do not leave floating.
16	EN2	Enable Input (LDO 2). Active High Input. Logic High = On; Logic Low = Off; Do not leave floating

**Absolute Maximum Ratings<sup>(1)</sup>**

Supply Voltage ( $V_{IN}$ , $V_{IN1}$ , $V_{IN2}$ ).....	0V to 6V
Enable Input Voltage ( $V_{EN}$ , $V_{EN1}$ , $V_{EN2}$ ).....	0V to $V_{IN}$
Power Dissipation .....	Internally Limited <sup>(3)</sup>
Lead Temperature (soldering, 10 sec.).....	260°C
Storage Temperature ( $T_s$ ) .....	-65°C to +150°C
ESD Rating <sup>(4)</sup> .....	2kV

**Operating Ratings<sup>(2)</sup>**

Supply Voltage ( $V_{IN}$ , $V_{IN2}$ ).....	2.7V to 5.5V
Supply Voltage ( $V_{IN1}$ ).....	1.65V to 5.5V
Enable Input Voltage ( $V_{EN}$ , $V_{EN1}$ , $V_{EN2}$ ).....	0V to $V_{IN}$
Junction Temperature ( $T_J$ ) .....	-40°C to +125°C
Junction Thermal Resistance MLF-16 ( $\theta_{JA}$ ) .....	56°C/W

**Electrical Characteristics<sup>(5)</sup>**

$V_{IN} = V_{IN1} = V_{IN2} = EN1 = EN2 = EN = /LOWQ = V_{OUT}^{(6)} + 1V$ ;  $C_{OUTDC/DC} = 2.2\mu F$ ,  $C_{LDO1} = C_{LDO2} = 2.2\mu F$ ;  $I_{OUTDC/DC} = 100mA$ ;  
 $I_{OUTLDO1} = I_{OUTLDO2} = 100\mu A$ ;  $T_J = 25^\circ C$ , **bold values indicate**  $-40^\circ C \leq T_J \leq +125^\circ C$ ; unless noted.

Parameter	Conditions	Min	Typ	Max	Units
UVLO Threshold	Rising input voltage during turn-on	<b>2.45</b>	2.55	<b>2.65</b>	V
UVLO Hysteresis			100		mV
Ground Pin Current	$V_{FB} = GND$ (not switching);		800	1100	$\mu A$
	LDO1 or LDO2 ( $EN = GND$ ; $EN1$ or $EN2 = GND$ )		55	<b>85</b> <b>95</b>	$\mu A$ $\mu A$
Ground Pin Current in Shutdown	$EN = EN1 = EN2 = 0V$		0.2	5	$\mu A$
Ground Pin Current (LOWQ <sup>®</sup> mode)	$I_{DC/DC} \leq I_{LDO1} \leq I_{LDO2} \leq 10mA$ ( $/LOWQ = GND$ )		38	60	$\mu A$
	LDO1 or LDO2 ( $EN = GND$ ; $EN1$ or $EN2 = GND$ ); $I_{OUT} \leq 10mA$ ( $/LOWQ = GND$ )		20	<b>80</b> <b>70</b>	$\mu A$ $\mu A$
Over-temperature Shutdown			160		$^\circ C$
Over-temperature Shutdown Hysteresis			23		$^\circ C$
<b>Enable Inputs (EN; EN1; EN2; /LOWQ)</b>					
Enable Input Voltage	Logic Low			<b>0.2</b>	V
	Logic High	<b>1.0</b>			V
Enable Input Current	$V_{IL} \leq 0.2V$		0.1	<b>1</b>	$\mu A$
	$V_{IH} \geq 1.0V$		0.1	<b>1</b>	$\mu A$
<b>Turn-on Time</b>					
Turn-on Time (LDO1 and LDO2)			240	<b>500</b>	$\mu s$
Turn-on Time (DC/DC)	( $/LOWQ = V_{IN}$ ; $I_{LOAD} = 300mA$ ); ( $/LOWQ = GND$ ; $I_{LOAD} = 10mA$ )		83	<b>350</b>	$\mu s$
<b>POR Output</b>					
VTH	Low Threshold, % of nominal ( $V_{DC/DC}$ or $V_{LDO1}$ or $V_{LDO2}$ ) (Flag ON)	90	91		%
	High Threshold, % of nominal ( $V_{DC/DC}$ AND $V_{LDO1}$ AND $V_{LDO2}$ ) (Flag OFF)		96	99	%
VOL	POR Output Logic Low Voltage; $I_L = 250\mu A$		10	<b>100</b>	mV
IPOR	Flag Leakage Current, Flag OFF		0.01	<b>1</b>	$\mu A$
<b>SET INPUT</b>					
SET Pin Current Source	$V_{SET} = 0V$	0.75	1.25	1.75	$\mu A$
SET Pin Threshold Voltage	POR = High		1.25		V

## Electrical Characteristics - DC/DC Converter

$V_{IN} = V_{OUTDC/DC} + 1$ ;  $EN = V_{IN}$ ;  $EN2 = EN1 = GND$ ;  $I_{OUTDC/DC} = 100mA$ ;  $L = 2.2\mu H$ ;  $C_{OUTDC/DC} = 2.2\mu F$ ;  $T_J = 25^\circ C$ ,  
**bold values indicate  $-40^\circ C$  to  $+125^\circ C$ ; unless noted.**

Parameter	Conditions	Min	Typ	Max	Units
<b>LOWQ = High (Full Power Mode)</b>					
Fixed Output Voltages	Nominal $V_{OUT}$ tolerance	-2 <b>-3</b>		+2 <b>+3</b>	% %
Output Voltage Line Regulation	$V_{OUT} > 2.4V$ ; $V_{IN} = V_{OUT} + 300mV$ to $5.5V$ , $I_{LOAD} = 100mA$ $V_{OUT} < 2.4V$ ; $V_{IN} = 2.7V$ to $5.5V$ , $I_{LOAD} = 100mA$		0.2		%/V
Output Voltage Load Regulation	$20mA < I_{LOAD} < 600mA$		0.1		%
Maximum Duty Cycle	$V_{FB} \leq 0.4V$	100			%
PWM Switch ON-Resistance	$I_{SW} = 150mA$ $V_{FB} = 0.7V_{FB\_NOM}$ PMOS $I_{SW} = -150mA$ $V_{FB} = 1.1V_{FB\_NOM}$ NMOS		0.5 0.6		$\Omega$ $\Omega$
Oscillator Frequency		<b>1.8</b>	2	<b>2.2</b>	MHz
Current Limit in PWM Mode	$V_{FB} = 0.9 * V_{NOM}$	0.75	1	1.6	A
<b>LOWQ = Low (Light Load Mode)</b>					
Output Voltage Accuracy	Variation from nominal $V_{OUT}$	-2		+2	%
	Variation from nominal $V_{OUT}$ ; $-40^\circ C$ to $+125^\circ C$	<b>-3</b>		<b>+3</b>	%
Line Regulation	$V_{IN} = V_{OUT} + 1V$ to $5.5V$ ; $I_{OUT} = 100\mu A$		0.02	0.3 <b>0.6</b>	%/V %/V
Load Regulation	$I_{OUT} = 100\mu A$ to $50mA$		0.4	1.5	%
Ripple Rejection	$f =$ up to $1kHz$		45		dB
Current Limit	$V_{OUT} = 0V$	80	120	<b>220</b>	mA
Output Voltage Noise	$10Hz$ to $100KHz$		53		$\mu V_{RMS}$

## Electrical Characteristics – LDO1/LDO2

$V_{IN1} = V_{IN2} = V_{OUTLDO1} + 1.0V$  or  $V_{IN1} = V_{IN2} = V_{OUTLDO2} + 1.0V$ ; EN = GND; EN1 = EN2 =  $V_{IN1} = V_{IN2}$ ;  $C_{LDO1} = C_{LDO2} = 2.2\mu F$ ;  $I_{OUTLDO1} = 100\mu A$ ;  $T_J = 25^\circ C$ , **bold** values indicate  $-40^\circ C \leq T_J \leq +125^\circ C$ ; unless noted.

Parameter	Conditions	Min	Typ	Max	Units
<b>LOWQ = High (Full Power Mode)</b>					
Output Voltage Accuracy	Variation from nominal $V_{OUT}$	-2		+2	%
	Variation from nominal $V_{OUT}$ ; $-40^\circ C$ to $+125^\circ C$	<b>-3</b>		<b>+3</b>	%
Line Regulation	$V_{IN} = V_{OUT} + 1V$ to 5.5V		0.02	0.3 <b>0.6</b>	%/V
Load Regulation	$I_{OUT} = 100\mu A$ to 150mA		0.20		%
	$I_{OUT} = 100\mu A$ to 200mA		0.25		%
	$I_{OUT} = 100\mu A$ to 300mA		0.40	<b>1.5</b>	%
Dropout Voltage	$I_{OUT} = 150mA$		70		mV
	$I_{OUT} = 200mA$		94		mV
	$I_{OUT} = 300mA$		142	<b>300</b>	mV
Ripple Rejection	f = up to 1kHz		35		dB
Current Limit	$V_{OUT} = 0V$	400	600	850	mA
Output Voltage Noise	10Hz to 100kHz		91		$\mu V_{RMS}$
<b>LOWQ = Low (Light Load Mode)</b>					
Output Voltage Accuracy	Variation from nominal $V_{OUT}$	-3		+3	%
	Variation from nominal $V_{OUT}$ ; $-40^\circ C$ to $+125^\circ C$	<b>-4</b>		<b>+4</b>	%
Line Regulation	$V_{IN} = V_{OUT} + 1V$ to 5.5V		0.02	0.3 <b>0.6</b>	%/V
Load Regulation	$I_{OUT} = 100\mu A$ to 10mA		0.2	<b>1.0</b>	%
Dropout Voltage	$I_{OUT} = 10mA$		22	35	mV
				<b>50</b>	mV
Ripple Rejection	f = up to 1kHz		35		dB
Current Limit	$V_{IN} = 2.7V$ ; $V_{OUT} = 0V$	50	85	125	mA

### Notes:

- Exceeding the absolute maximum rating may damage the device.
- The device is not guaranteed to function outside its operating rating.
- The maximum allowable power dissipation of any  $T_A$  (ambient temperature) is  $P_{D(max)} = (T_{J(max)} - T_A) / \theta_{JA}$ . Exceeding the maximum allowable power dissipation will result in excessive die temperature, and the regulator will go into thermal shutdown.
- Devices are ESD sensitive. Handling precautions recommended. Human body model, 1.5k in series with 100pF.
- Specification for packaged product only.

### Typical Characteristics — DC/DC Normal Mode (/LOWQ = VIN)

1.2V<sub>OUT</sub> Efficiency

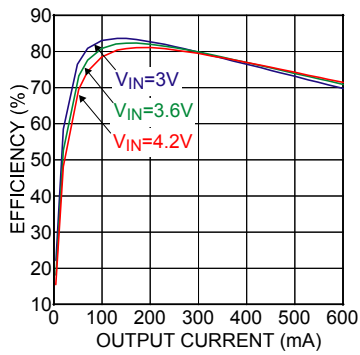

Switching Frequency vs. Input Voltage

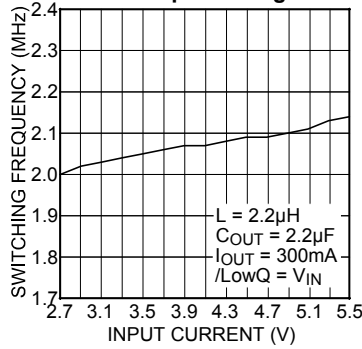

Switching Frequency vs. Temperature

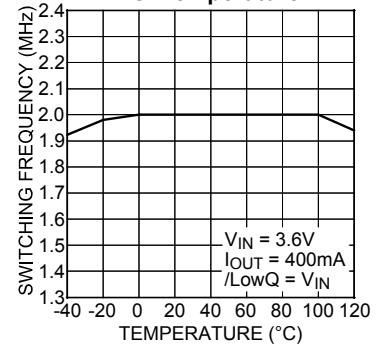

Load Regulation

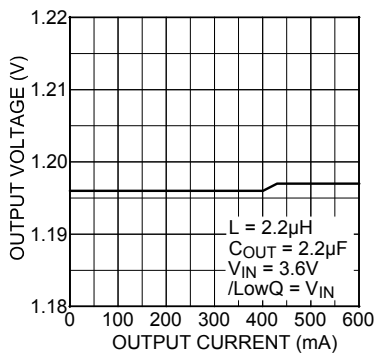

Line Regulation

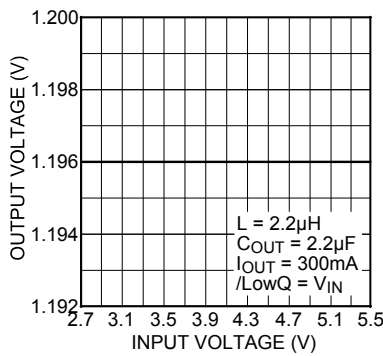

Current Limit vs. Input Voltage

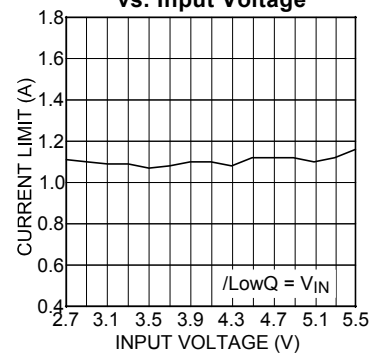

### Typical Characteristics — DC/DC LOWQ Mode (/LOWQ = GND)

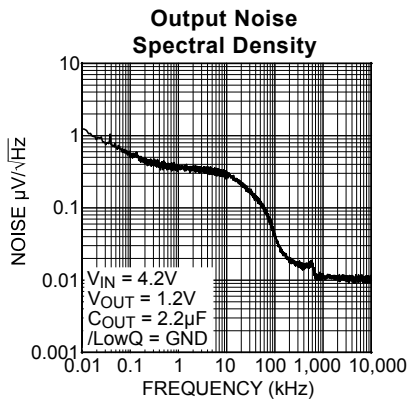
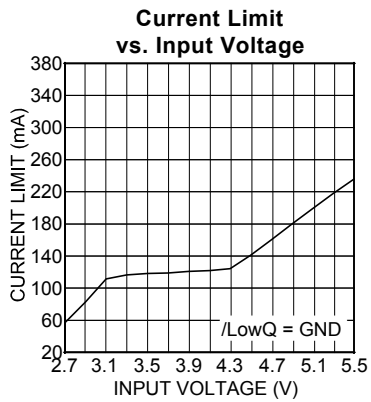
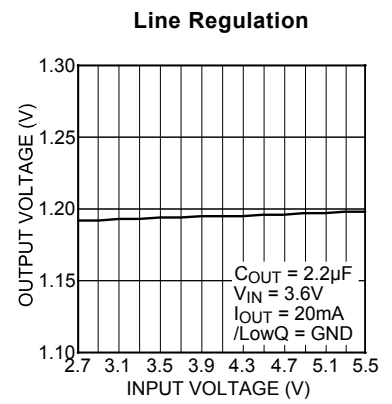
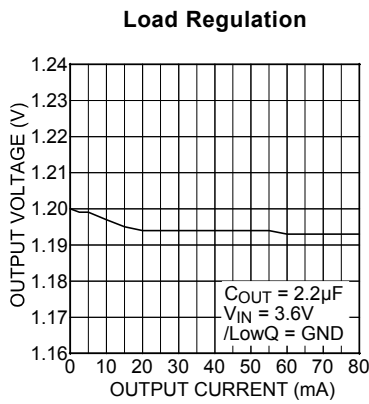
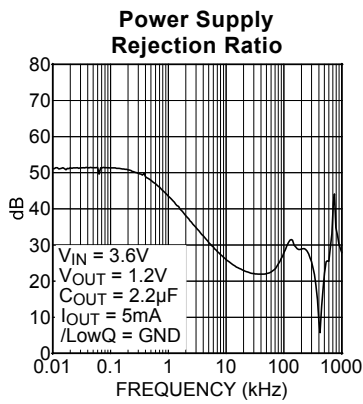



# Typical Characteristics — LDO1/LDO2

**Power Supply Rejection Ratio  
LDO1[LOWQ Mode]**

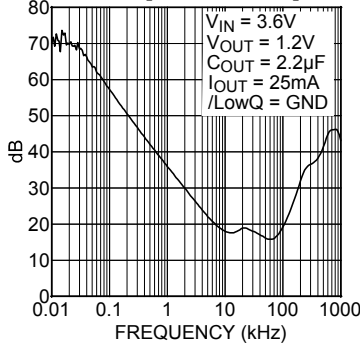

**Power Supply Rejection Ratio  
LDO1[Normal Mode]**

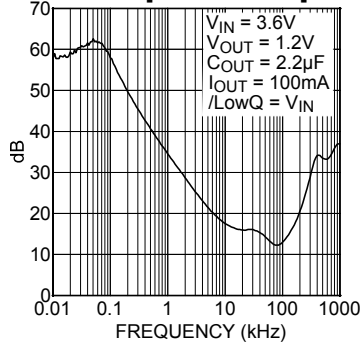

**LDO1 Line Regulation**

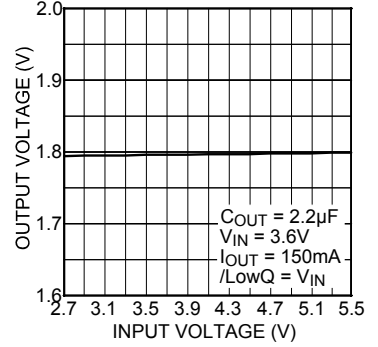

**Power Supply Rejection Ratio  
LDO2[LOWQ Mode]**

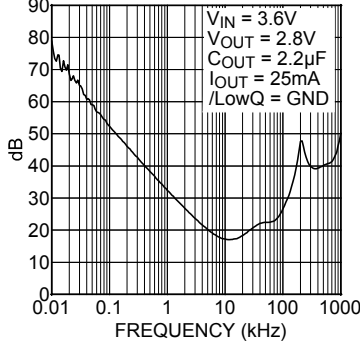

**Power Supply Rejection Ratio  
LDO2[Normal Mode]**

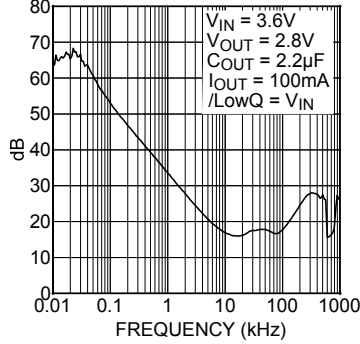

**LDO2 Load Regulation**

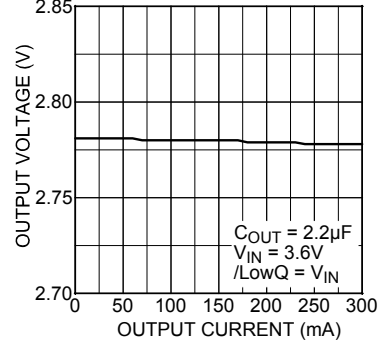

**LDO2 Ground Current  
vs. Output Current**

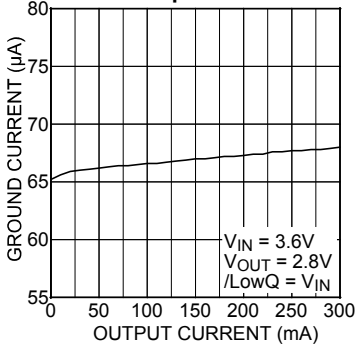

**LDO2 Ground Current  
vs. Temperature**

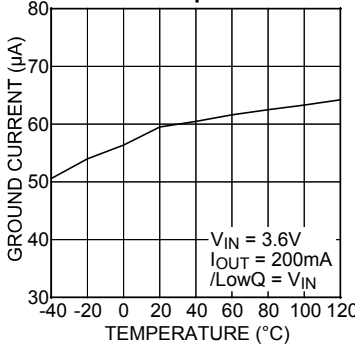

**LDO2 Dropout Voltage  
vs. Output Current**

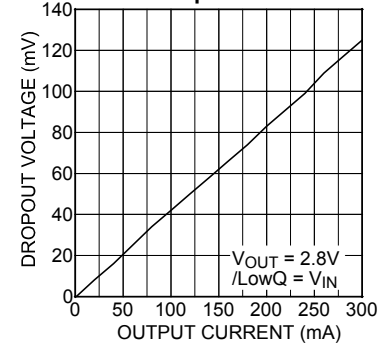

**LDO2 Dropout Voltage  
vs. Temperature**

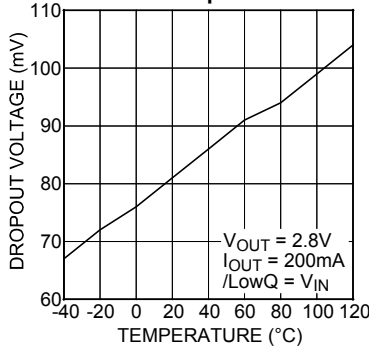

**LDO2 Output Noise  
Spectral Density**

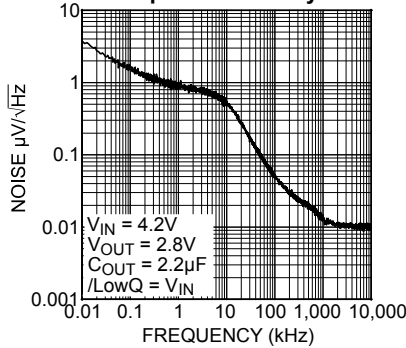

## Functional Characteristics

**LDO2<sub>[LOWQ Mode]</sub> Load Transient**

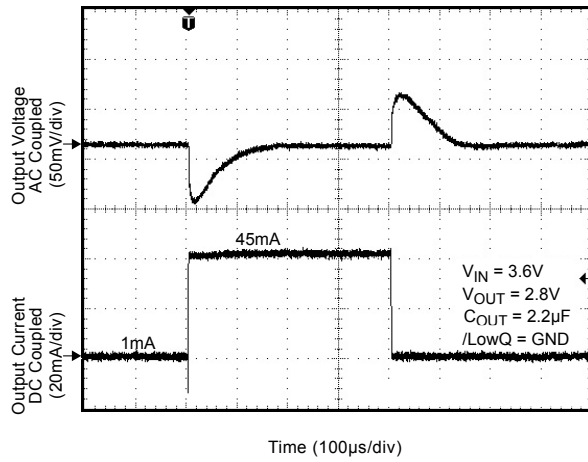

**LDO2<sub>[Normal Mode]</sub> Load Transient**

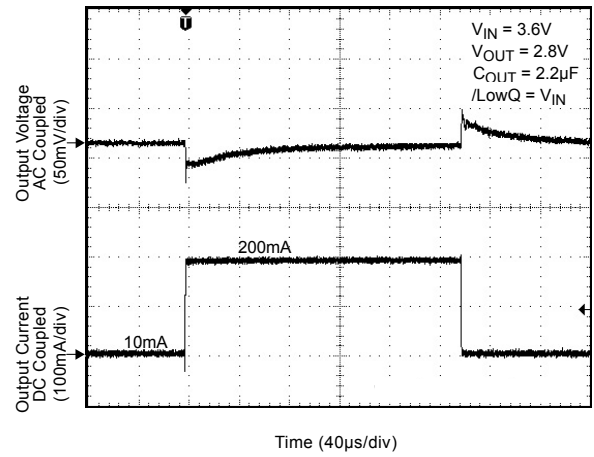

**DC/DC<sub>[LOWQ Mode]</sub> Load Transient**

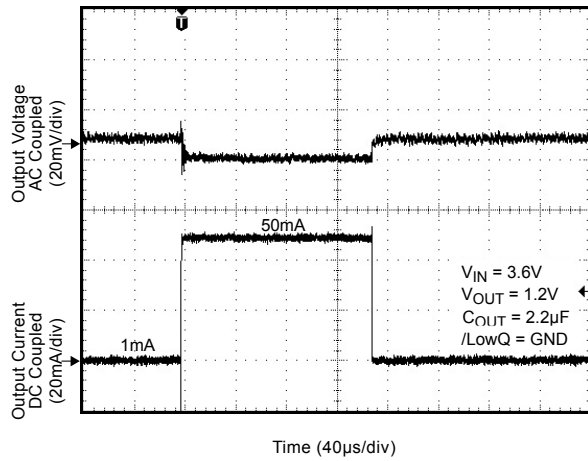

**DC/DC<sub>[LOWQ Mode]</sub> Start-Up Waveforms**

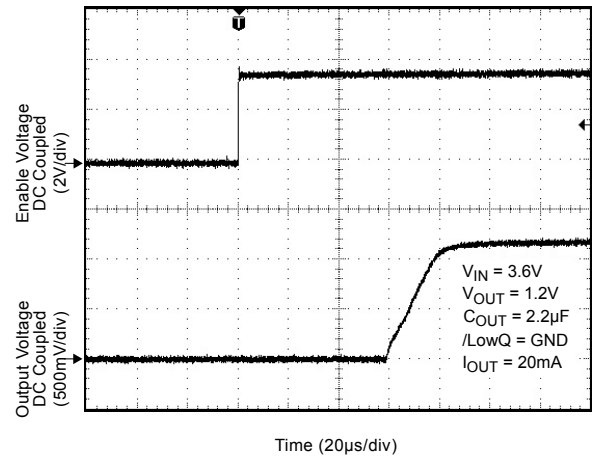

## Functional Characteristics (cont.)

**DC/DC PWM Waveforms**

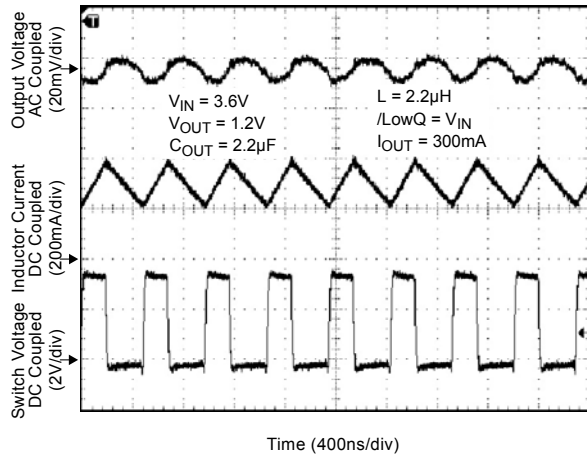

**DC/DC Load Transient**

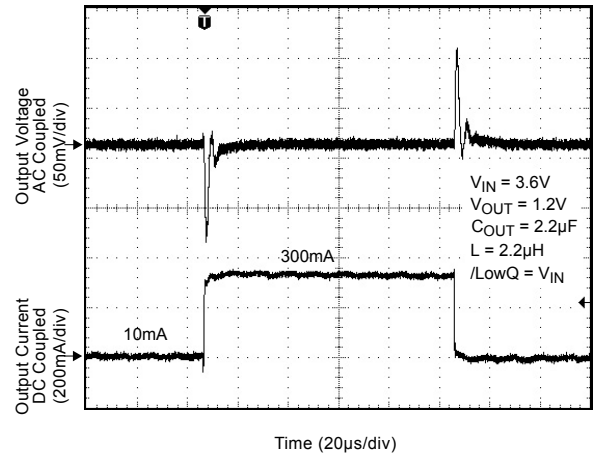

**DC/DC Start-Up Waveforms**

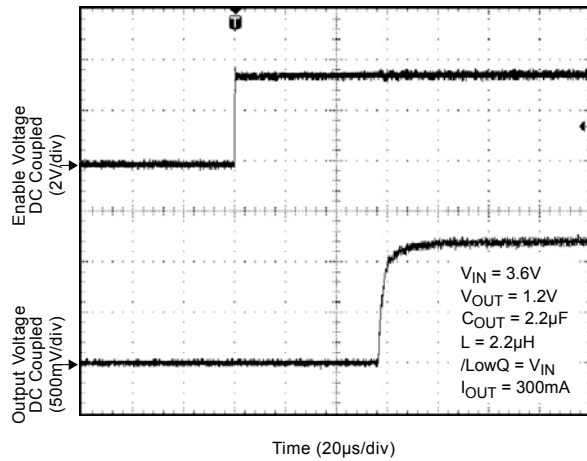

### Functional Diagram

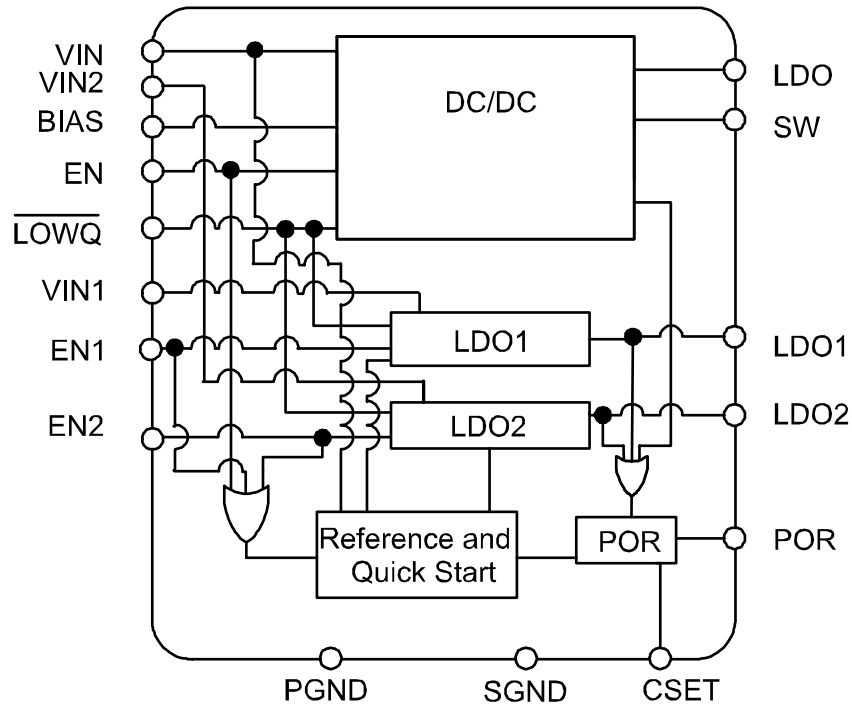

**MIC2810 Block Diagram**

## Device Functional Description

The MIC2810 is a power management IC with a single integrated step-down regulator and two low dropout regulators. LDO1 and LDO2 are 300mA low dropout regulators supplied from the input voltage pins. The step-down regulator is a 600mA PWM power supply. All three regulators utilize a /LOWQ light load mode to maximize battery efficiency under light load conditions. This is achieved with a /LOWQ control pin that when pulled low shuts down all the biasing and drive current for the PWM regulator, along with reducing the current limit of the two independent LDOs. When the /LOWQ pin is pulled low, the MIC2810 draws only 30 $\mu$ A of operating current. This mode allows the output to be regulated through the LDO output which is capable of providing 60mA of output current. This method has the advantage of producing a clean, low current, ultra-low noise output in /LOWQ mode. During /LOWQ mode, the SW node becomes high impedance, blocking current flow. Other methods of reducing quiescent current, such as pulse frequency modulation (PFM) or bursting techniques create large amplitude and low frequency ripple voltages that can be detrimental to system operation.

When more than 60mA is required, the /LOWQ pin can be forced high, causing the MIC2810 to enter PWM mode. In this case, the LDO output makes a "hand-off" to the PWM regulator with virtually no variation in output voltage. The LDO output then turns off allowing up to 600mA of current to be efficiently supplied through the PWM output to the load.

## Pin Functional Description

### VIN/VIN1/VIN2

Three input voltage pins provide power to the switch mode regulator, LDO1, and LDO2. VIN provides power to the control circuitry of the DC/DC converter and voltage reference circuitry shared by all the regulators in the MIC2810. LDO1's input voltage (VIN1) can go down to 1.65V but LDO2 and the DC/DC converter input voltages are limited to 2.7V minimum.

For the switch mode regulator VIN provides power to the MOSFET along with current limiting sense circuitry. Due to the high switching speeds, a 4.7 $\mu$ F capacitor is recommended close to VIN and the power ground (PGND) pin for bypassing. Please refer to the PCB layout section for an example of an appropriate circuit layout.

### LDO

The LDO pin is the output of the linear regulator and should be connected to the output of the step-down PWM regulator. In /LOWQ mode (/LOWQ < 0.2V), the LDO provides the output voltage of the DC/DC regulator.

### LDO1

Regulated output voltage of LDO1. Power is provided by VIN1. Recommended output capacitance is 2.2 $\mu$ F.

### LDO2

Regulated output voltage of LDO2. Power is provided by VIN2. Recommended output capacitance is 2.2 $\mu$ F.

### EN/EN1/EN2

All enable inputs are active high, requiring 1.0V for guaranteed operation. EN provides logic control for the DC/DC regulator. EN2 provides logic control for LDO2, and EN1 provides logic control for LDO1. The enable inputs are CMOS logic and cannot be left floating.

The enable pins provide logic level control of the specified outputs. When all enable pins are in the off state, supply current of the device is greatly reduced (typically < 1 $\mu$ A). When the DC/DC regulator is in the off state, the output drive is placed in a "tri-stated" condition, where both the high side P-channel MOSFET and the low-side N-channel are in an "off" or non-conducting state. Do not drive any of the enable pins above the supply voltage.

### Power-On Reset (POR)

The power-on reset output is an open-drain N-Channel device, requiring a pull-up resistor to either the input voltage or output voltage for proper voltage levels. The POR output has a delay time that is programmable with a capacitor from the CSET pin to ground. The delay time can be programmed to be as long as 1 second.

### /LOWQ

The /LOWQ pin provides a logic level control between the internal PWM switching regulator mode, and the low noise linear regulator mode. With /LOWQ pulled low ( $\leq 0.2V$ ), quiescent current of the device is greatly reduced by switching to a low noise linear regulator mode that has a typical supply current of 38 $\mu$ A. In linear (LDO) mode the output can deliver 60mA of current to the output. By placing /LOWQ high ( $\geq 1V$ ), the device transitions into a constant frequency PWM step-down regulator mode. This allows the device the ability to efficiently deliver up to 600mA of output current at the same output voltage.

/LOWQ mode also limits the output load of both LDO1 and LDO2 to < 50mA.

### BIAS

The BIAS pin supplies the power to the internal control and reference circuitry. The bias is powered from VIN through an internal 6 $\Omega$  resistor. A small 0.1 $\mu$ F capacitor is recommended for bypassing.

**SW**

The switch (SW) pin connects directly to the inductor and provides the switching current necessary to operate in PWM mode. Due to the high speed switching on this pin, the switch node should be routed away from sensitive nodes.

**PGND**

Power ground (PGND) is the ground path for the high current PWM mode. The current loop for the power ground should be as small as possible.

**SGND**

Signal ground (SGND) is the ground path for the biasing and control circuitry. The current loop for the signal ground should be as small as possible.

**CSET**

The CSET pin is a current source output that charges a capacitor that sets the delay time for the power-on reset output from low to high. The delay for POR high to low (detecting an undervoltage on any of the outputs) is always minimal. The current source of 1.25 $\mu$ A charges a capacitor up from 0V. When the capacitor reaches 1.25V, the output of the POR is allowed to go high. The delay time in microseconds is equal to the Cset in picofarads.

$$\text{POR Delay } (\mu\text{s}) = \text{CSET (pF)}$$

**Component Selection****Output Capacitor**

LDO1 and LDO2 outputs require a 2.2 $\mu$ F ceramic output capacitor for stability. The DC/DC switch mode regulator also requires a 2.2 $\mu$ F ceramic output capacitor to be stable. All output capacitor values can be increased to improve transient response, but performance has been optimized for a 2.2 $\mu$ F ceramic on the LDOs and the DC/DC regulator. X7R/X5R dielectric-type ceramic capacitors are recommended because of their temperature performance. X5R/X7R-type capacitors change capacitance by 15% over their operating temperature range and are the most stable type of ceramic capacitors. Z5U and Y5V dielectric capacitors change value by as much as 50% to 60% respectively over their operating temperature ranges.

**Input Capacitor**

A minimum 1 $\mu$ F ceramic, 4.7 $\mu$ F recommended, should be placed as close as possible to the VIN pin for optimal bypassing. X5R or X7R dielectrics are recommended for the input capacitor. Y5V dielectrics lose most of their capacitance over temperature and are therefore, not recommended. A minimum 1 $\mu$ F is recommended close to the VIN and PGND pins for high frequency filtering. Smaller case size capacitors are recommended due to their lower ESR and ESL. Please refer to the PCB layout section for an example of an appropriate circuit layout.

**Inductor Selection**

The MIC2810 is designed for use with a 2.2 $\mu$ H inductor. Proper selection should ensure the inductor can handle the maximum average and peak currents required by the load. Maximum current ratings of the inductor are generally given in two methods; permissible DC current and saturation current. Permissible DC current can be rated either for a 40°C temperature rise or a 10% to 20% loss in inductance. Ensure that the inductor selected can handle the maximum operating current. When saturation current is specified, make sure that there is enough margin that the peak current will not saturate the inductor. Peak inductor current can be calculated as follows:

$$I_{PK} = I_{OUT} + \frac{V_{OUT} \left( 1 - \frac{V_{OUT}}{V_{IN}} \right)}{2 \times f \times L}$$

- $I_{PK}$ : Peak Inductor Current
- $I_{OUT}$ : Output/Load Current
- $V_{IN}$ : Input Voltage
- $V_{OUT}$ : Output Voltage
- f: Switching Frequency of PWM Regulator
- L: Inductor Value

PCB Layout

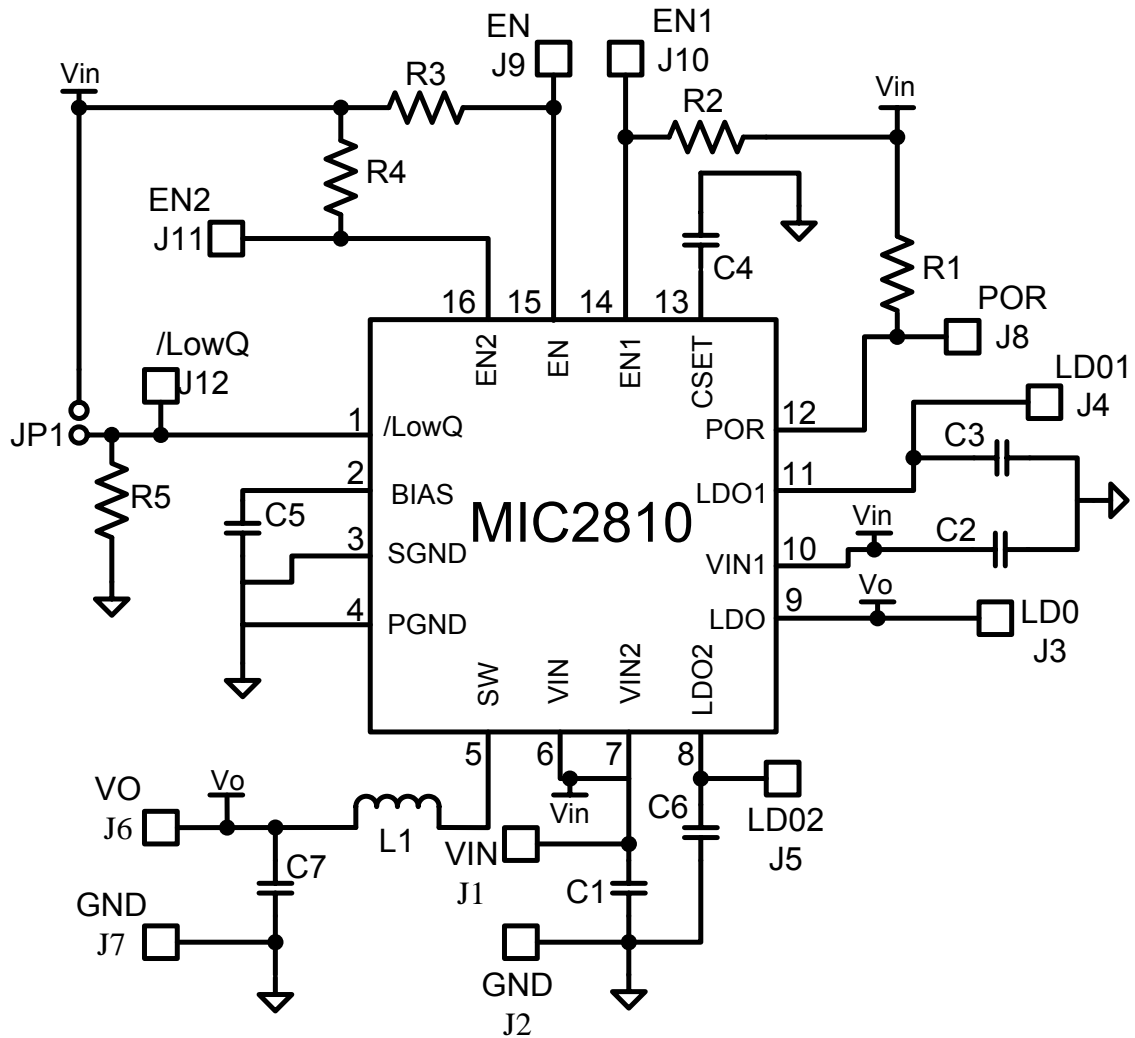

Layout Schematic

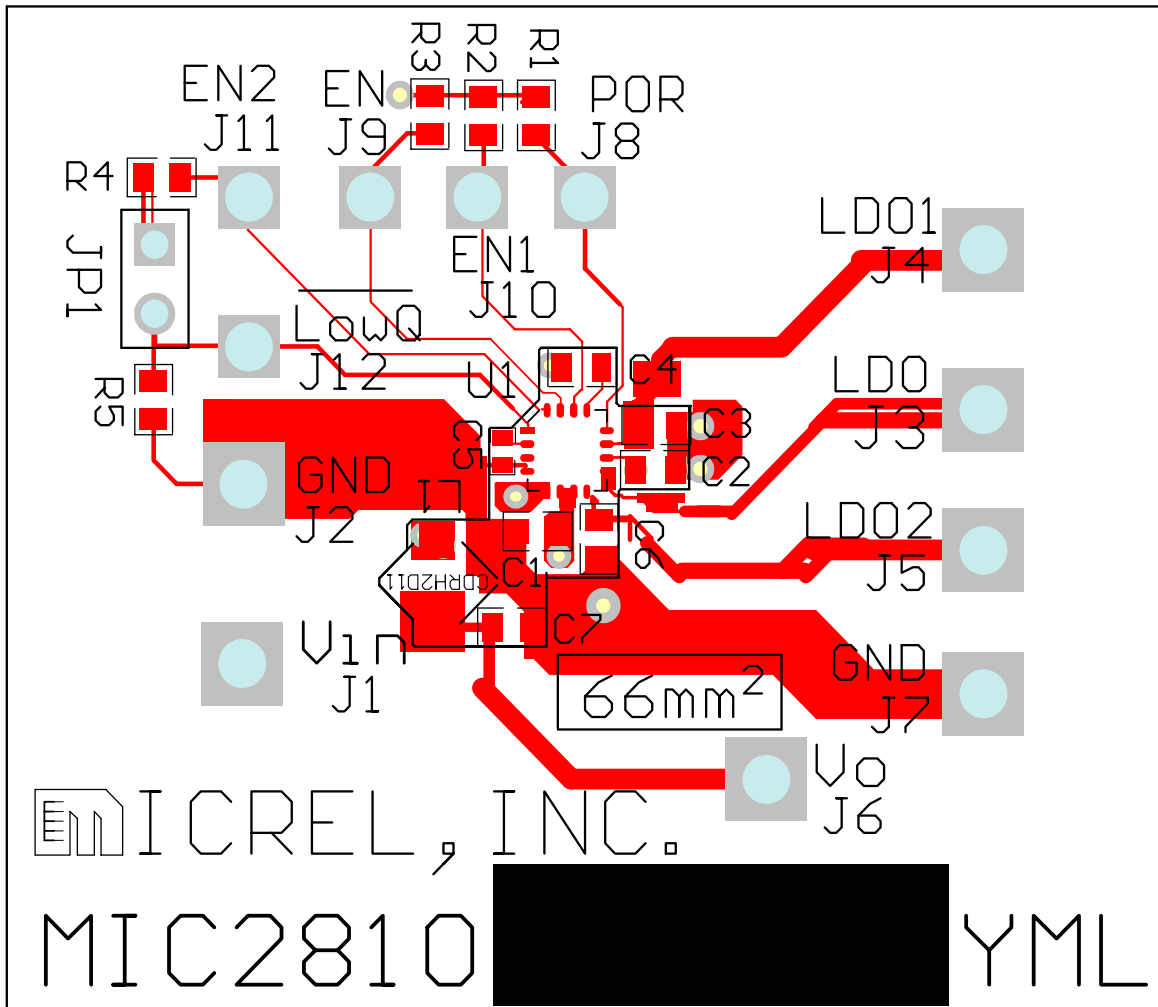

Top Layer



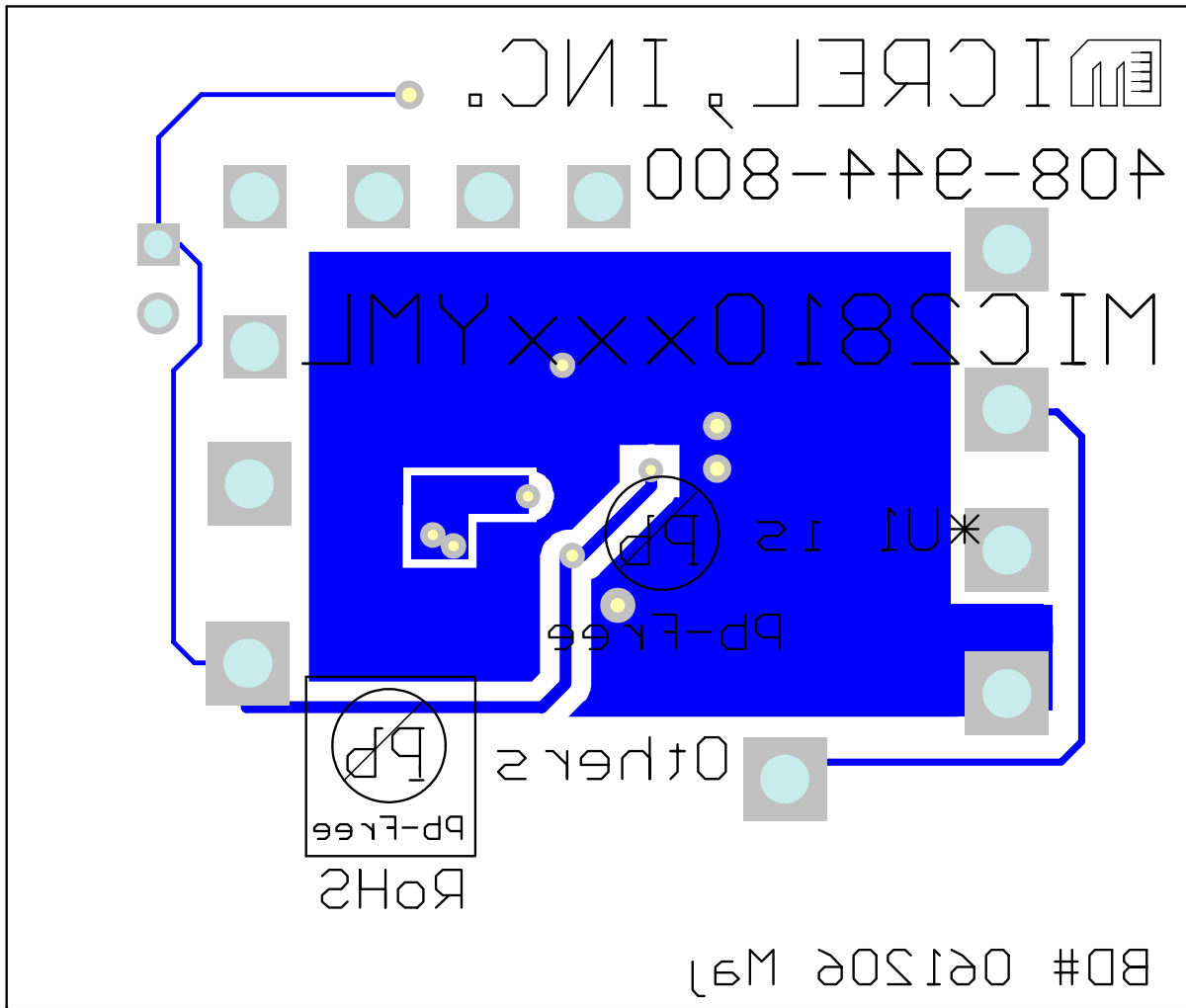

Bottom Layer

## Package Information

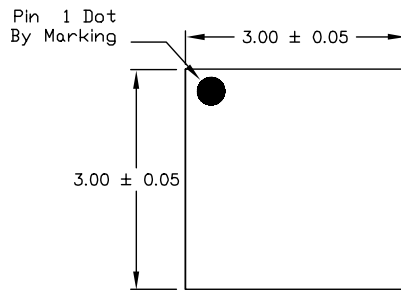

TOP VIEW

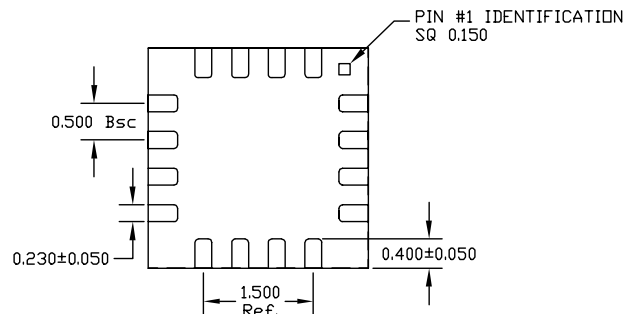

BOTTOM VIEW

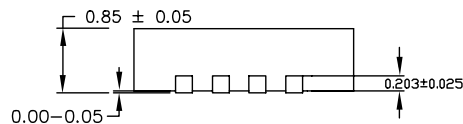

SIDE VIEW

## NOTES:

1. ALL DIMENSIONS ARE IN MILLIMETERS, ANGLES ARE IN DEGREES.  
N IS THE TOTAL NUMBER OF TERMINALS.
2. MAX PACKAGE WARPAGE IS 0.05mm, MAX ALLOWABLE BURRS IS 0.076 mm IN ALL DIRECTIONS.
3. PIN #1 ID ON TOP WILL BE LASER/INK MARKED.

### 16-Pin 3mm x 3mm MLF<sup>®</sup> (ML)

**MICREL, INC. 2180 FORTUNE DRIVE SAN JOSE, CA 95131 USA**  
 TEL +1 (408) 944-0800 FAX +1 (408) 474-1000 WEB <http://www.micrel.com>

The information furnished by Micrel in this data sheet is believed to be accurate and reliable. However, no responsibility is assumed by Micrel for its use. Micrel reserves the right to change circuitry and specifications at any time without notification to the customer.

Micrel Products are not designed or authorized for use as components in life support appliances, devices or systems where malfunction of a product can reasonably be expected to result in personal injury. Life support devices or systems are devices or systems that (a) are intended for surgical implant into the body or (b) support or sustain life, and whose failure to perform can be reasonably expected to result in a significant injury to the user. A Purchaser's use or sale of Micrel Products for use in life support appliances, devices or systems is a Purchaser's own risk and Purchaser agrees to fully indemnify Micrel for any damages resulting from such use or sale.

© 2006 Micrel, Incorporated.

Компания «Океан Электроники» предлагает заключение долгосрочных отношений при поставках импортных электронных компонентов на взаимовыгодных условиях!

Наши преимущества:

- Поставка оригинальных импортных электронных компонентов напрямую с производств Америки, Европы и Азии, а так же с крупнейших складов мира;
- Широкая линейка поставок активных и пассивных импортных электронных компонентов (более 30 млн. наименований);
- Поставка сложных, дефицитных, либо снятых с производства позиций;
- Оперативные сроки поставки под заказ (от 5 рабочих дней);
- Экспресс доставка в любую точку России;
- Помощь Конструкторского Отдела и консультации квалифицированных инженеров;
- Техническая поддержка проекта, помощь в подборе аналогов, поставка прототипов;
- Поставка электронных компонентов под контролем ВП;
- Система менеджмента качества сертифицирована по Международному стандарту ISO 9001;
- При необходимости вся продукция военного и аэрокосмического назначения проходит испытания и сертификацию в лаборатории (по согласованию с заказчиком);
- Поставка специализированных компонентов военного и аэрокосмического уровня качества (Xilinx, Altera, Analog Devices, Intersil, Interpoint, Microsemi, Actel, Aeroflex, Peregrine, VPT, Syfer, Eurofarad, Texas Instruments, MS Kennedy, Miteq, Cobham, E2V, MA-COM, Hittite, Mini-Circuits, General Dynamics и др.);

Компания «Океан Электроники» является официальным дистрибьютором и эксклюзивным представителем в России одного из крупнейших производителей разъемов военного и аэрокосмического назначения «JONHON», а так же официальным дистрибьютором и эксклюзивным представителем в России производителя высокотехнологичных и надежных решений для передачи СВЧ сигналов «FORSTAR».



## JONHON

«JONHON» (основан в 1970 г.)

Разъемы специального, военного и аэрокосмического назначения:

(Применяются в военной, авиационной, аэрокосмической, морской, железнодорожной, горно- и нефтедобывающей отраслях промышленности)

«FORSTAR» (основан в 1998 г.)

ВЧ соединители, коаксиальные кабели, кабельные сборки и микроволновые компоненты:

(Применяются в телекоммуникациях гражданского и специального назначения, в средствах связи, РЛС, а так же военной, авиационной и аэрокосмической отраслях промышленности).



Телефон: 8 (812) 309-75-97 (многоканальный)

Факс: 8 (812) 320-03-32

Электронная почта: [ocean@oceanchips.ru](mailto:ocean@oceanchips.ru)

Web: <http://oceanchips.ru/>

Адрес: 198099, г. Санкт-Петербург, ул. Калинина, д. 2, корп. 4, лит. А