

2SC5509

NPN SILICON RF TRANSISTOR

FOR MEDIUM OUTPUT POWER, LOW-NOISE, HIGH-GAIN AMPLIFICATION

FLAT-LEAD 4-PIN THIN-TYPE SUPER MINIMOLD (M04)

R09DS0056EJ0300

Rev.3.00

Mar 5, 2013

FEATURES

- Ideal for medium output power amplification
- $NF = 1.2$ dB TYP., $G_a = 12$ dB TYP. @ $V_{CE} = 2$ V, $I_C = 10$ mA, $f = 2$ GHz
- Maximum available power gain: $MAG = 14$ dB TYP. @ $V_{CE} = 2$ V, $I_C = 50$ mA, $f = 2$ GHz
- $f_T = 25$ GHz technology adopted
- Flat-lead 4-pin thin-type super minimold (M04) package

<R> ORDERING INFORMATION

Part Number	Order Number	Quantity	Package	Supplying Form
2SC5509	2SC5509-A	50 pcs (Non reel)	Flat-lead 4-pin thin-type super minimold (M04) (Pb-Free)	<ul style="list-style-type: none"> • 8 mm wide embossed taping • Pin 1 (Emitter), Pin 2 (Collector) face the perforation side of the tape
2SC5509-T2	2SC5509-T2-A	3 kpcs/reel		

Remark To order evaluation samples, please contact your nearby sales office.

The unit sample quantity is 50 pcs.

ABSOLUTE MAXIMUM RATINGS ($T_C = 25^\circ\text{C}$)

Parameter	Symbol	Ratings	Unit
Collector to Base Voltage	V_{CBO}	15	V
Collector to Emitter Voltage	V_{CEO}	3.3	V
Emitter to Base Voltage	V_{EBO}	1.5	V
Collector Current	I_C	100	mA
Total Power Dissipation	P_{tot} ^{Note}	190	mW
Junction Temperature	T_j	150	$^\circ\text{C}$
Storage Temperature	T_{stg}	-65 to +150	$^\circ\text{C}$

Note Free air.

THERMAL RESISTANCE

Parameter	Symbol	Ratings	Unit
Junction to Case Resistance	$R_{th\ j-c}$	95	$^\circ\text{C} / \text{W}$
Junction to Ambient Resistance	$R_{th\ j-a}$	650	$^\circ\text{C} / \text{W}$

CAUTION

Observe precautions when handling because these devices are sensitive to electrostatic discharge.

The mark <R> shows major revised points.

The revised points can be easily searched by copying an "<R>" in the PDF file and specifying it in the "Find what:" field.

ELECTRICAL CHARACTERISTICS (T_A = +25 °C)

Parameter	Symbol	Conditions	MIN.	TYP.	MAX.	Unit
DC Characteristics						
Collector Cut-off Current	I _{CBO}	V _{CB} = 5 V, I _E = 0	–	–	600	nA
Emitter Cut-off Current	I _{EBO}	V _{EB} = 1 V, I _C = 0	–	–	600	nA
DC Current Gain	h _{FE} ^{Note 1}	V _{CE} = 2 V, I _C = 10 mA	50	70	100	–
RF Characteristics						
Gain Bandwidth Product	f _T	V _{CE} = 3 V, I _C = 90 mA, f = 2 GHz	13	15	–	GHz
Insertion Power Gain	S _{21e} ²	V _{CE} = 2 V, I _C = 50 mA, f = 2 GHz	8	11	–	dB
Noise Figure	NF	V _{CE} = 2 V, I _C = 10 mA, f = 2 GHz, Z _S = Z _{opt}	–	1.2	1.7	dB
Reverse Transfer Capacitance	C _{re} ^{Note 2}	V _{CB} = 2 V, I _E = 0, f = 1 MHz	–	0.5	0.75	pF
Maximum Available Power Gain	MAG ^{Note 3}	V _{CE} = 2 V, I _C = 50 mA, f = 2 GHz	–	14	–	dB
Maximum Stable Power Gain	MSG ^{Note 4}	V _{CE} = 2 V, I _C = 50 mA, f = 2 GHz	–	15	–	dB
Gain 1 dB Compression Output Power	P _{O(1 dB)}	V _{CE} = 2 V, I _C = 70 mA ^{Note 5} , f = 2 GHz	–	17	–	dBm
3rd Order Intermodulation Distortion Output Intercept Point	OIP ₃	V _{CE} = 2 V, I _C = 70 mA ^{Note 5} , f = 2 GHz	–	27	–	dBm

- Notes**
1. Pulse measurement: PW ≤ 350 μs, Duty Cycle ≤ 2%
 2. Collector to base capacitance when the emitter grounded
 3. $MAG = \left| \frac{S_{21}}{S_{12}} \right| (K - \sqrt{K^2 - 1})$
 4. $MSG = \left| \frac{S_{21}}{S_{12}} \right|$
 5. Collector current when P_{O(1 dB)} is output

h_{FE} CLASSIFICATION

Rank	FB/YFB
Marking	T80
h _{FE} Value	50 to 100

TYPICAL CHARACTERISTICS (T_A = +25°C, unless otherwise specified)

Thermal/DC Characteristics

TOTAL POWER DISSIPATION vs. AMBIENT TEMPERATURE, CASE TEMPERATURE

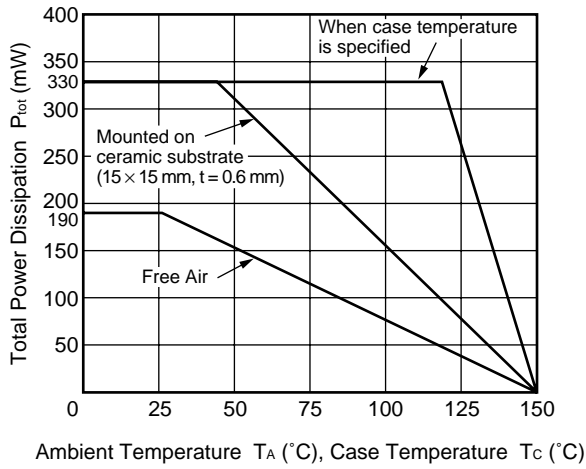

COLLECTOR CURRENT vs. BASE TO EMITTER VOLTAGE

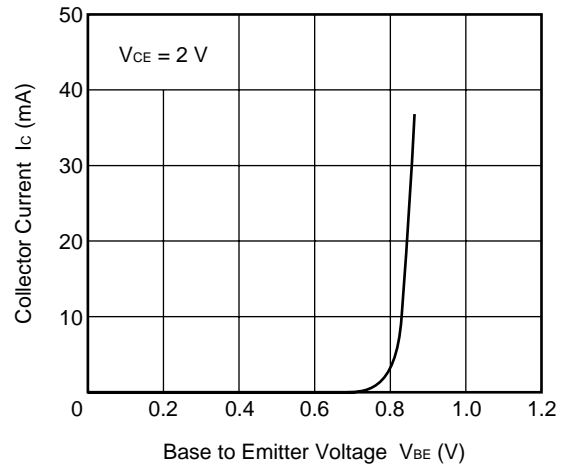

COLLECTOR CURRENT vs. COLLECTOR TO EMITTER VOLTAGE

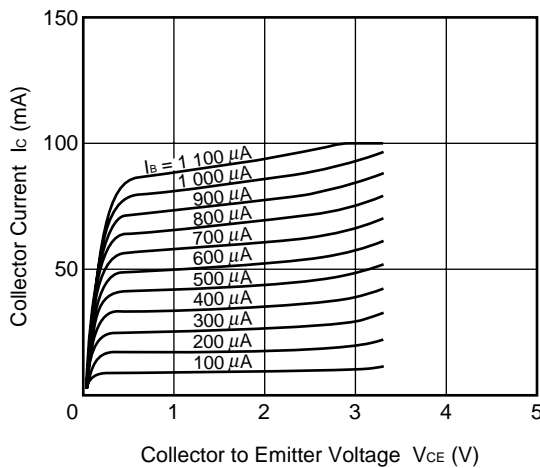

DC CURRENT GAIN vs. COLLECTOR CURRENT

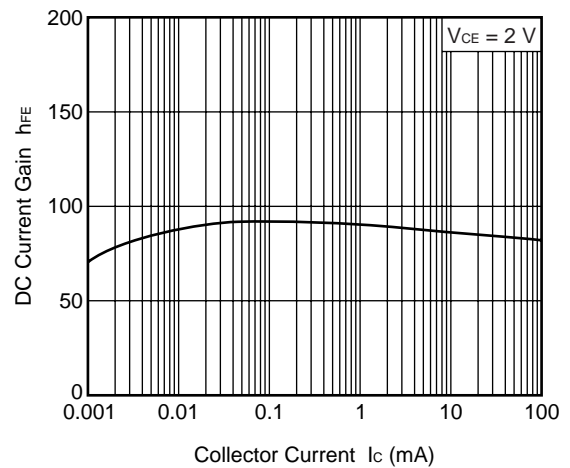

Capacitance/f_T Characteristics

REVERSE TRANSFER CAPACITANCE vs. COLLECTOR TO BASE VOLTAGE

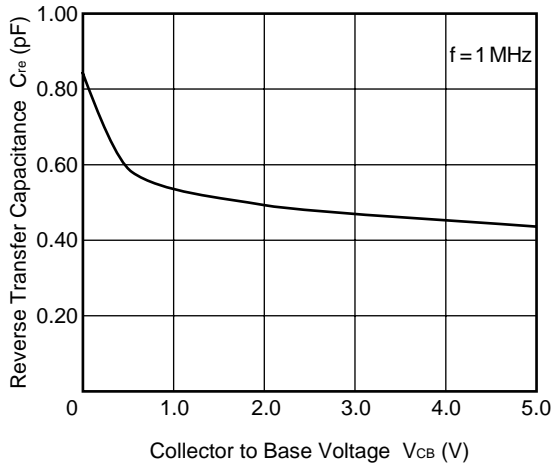

GAIN BANDWIDTH PRODUCT vs. COLLECTOR CURRENT

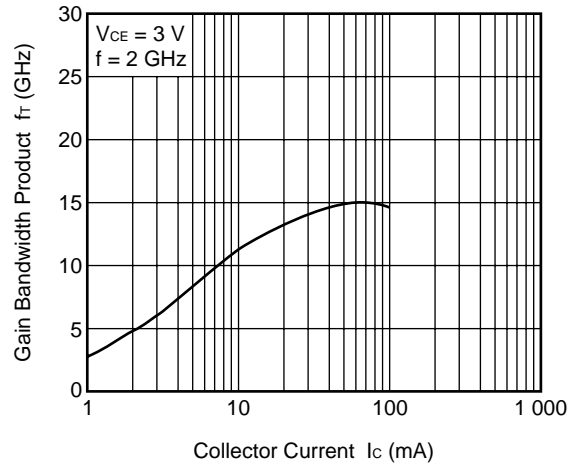

Remark The graphs indicate nominal characteristics.

Gain Characteristics

INSERTION POWER GAIN, MAG, MSG vs. FREQUENCY

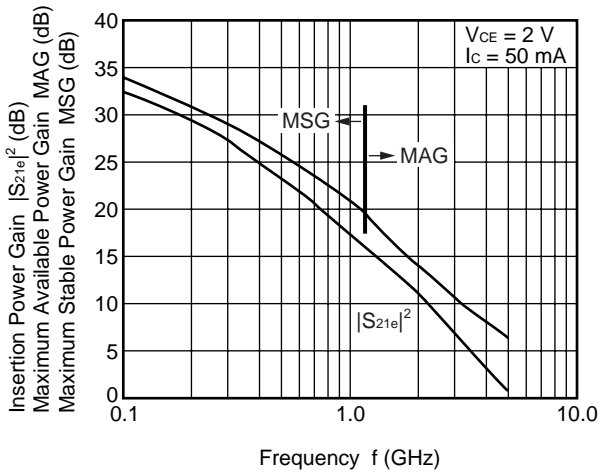

INSERTION POWER GAIN, MAG, MSG vs. COLLECTOR CURRENT

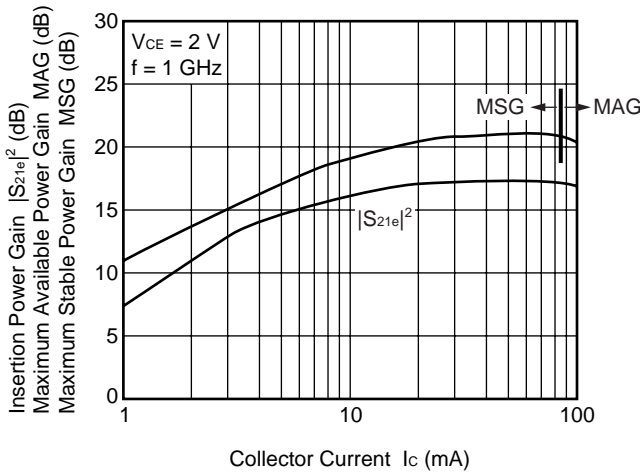

INSERTION POWER GAIN, MAG, MSG vs. COLLECTOR CURRENT

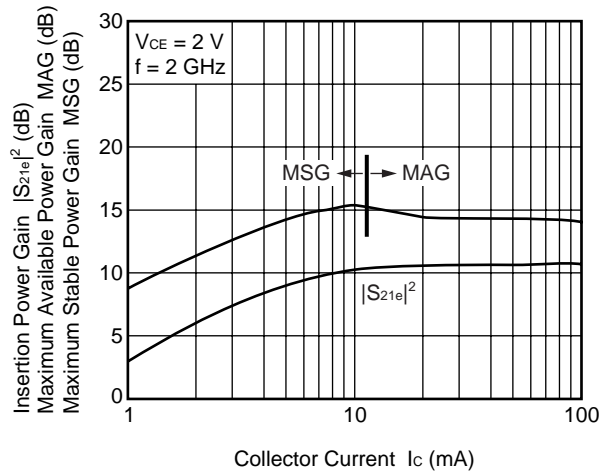

Output Characteristics

OUTPUT POWER, COLLECTOR CURRENT vs. INPUT POWER

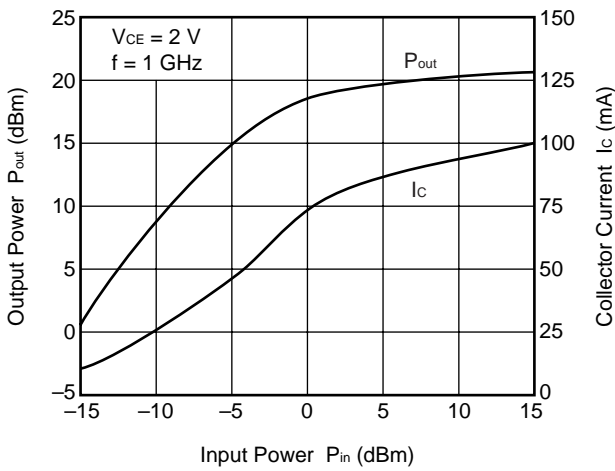

OUTPUT POWER, COLLECTOR CURRENT vs. INPUT POWER

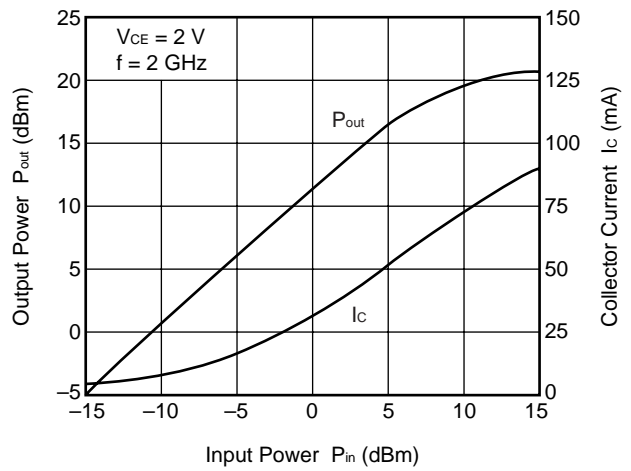

Remark The graphs indicate nominal characteristics.

Noise Characteristics

NOISE FIGURE, ASSOCIATED GAIN vs. COLLECTOR CURRENT

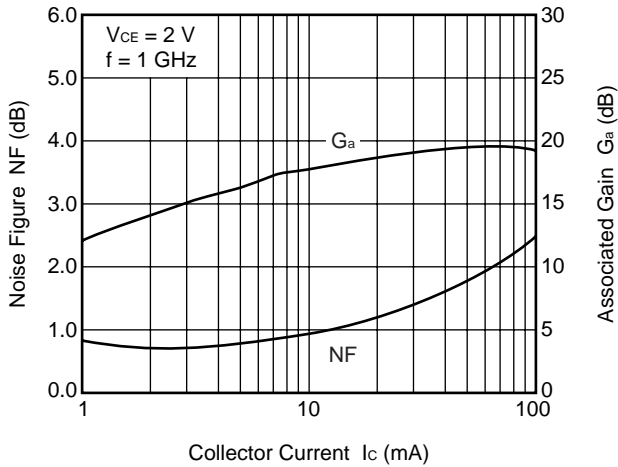

NOISE FIGURE, ASSOCIATED GAIN vs. COLLECTOR CURRENT

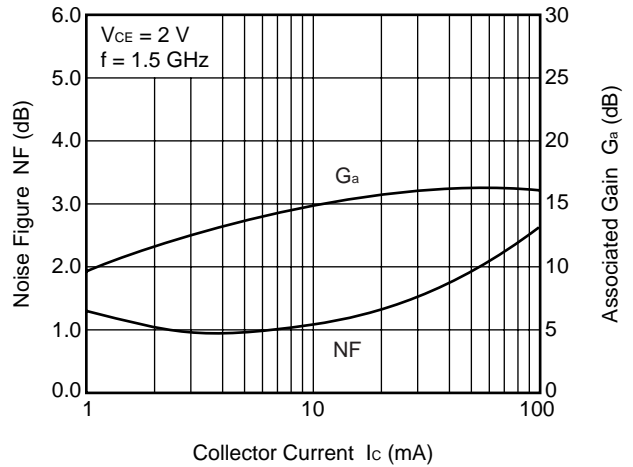

NOISE FIGURE, ASSOCIATED GAIN vs. COLLECTOR CURRENT

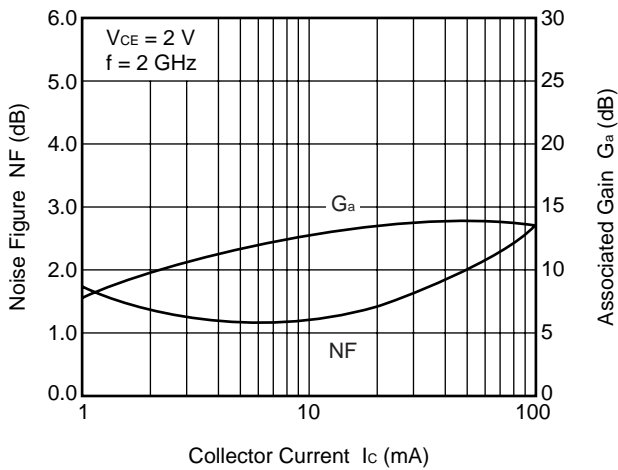

NOISE FIGURE, ASSOCIATED GAIN vs. COLLECTOR CURRENT

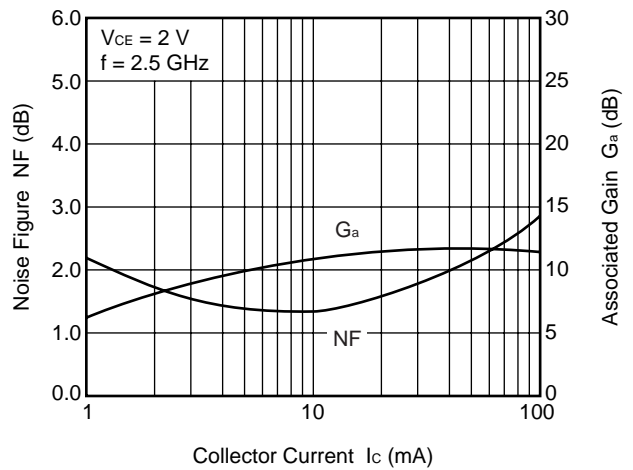

Remark The graphs indicate nominal characteristics.

<R> **S-PARAMETERS**

S-parameters and noise parameters are provided on our web site in a form (S2P) that enables direct import of the parameters to microwave circuit simulators without the need for keyboard inputs.

Click here to download S-parameters.

[Products] → [RF Devices] → [Device Parameters]

URL <http://www.renesas.com/products/microwave/>

EQUAL NF CIRCLE

$V_{CE} = 2\text{ V}$
 $I_C = 10\text{ mA}$
 $f = 1\text{ GHz}$

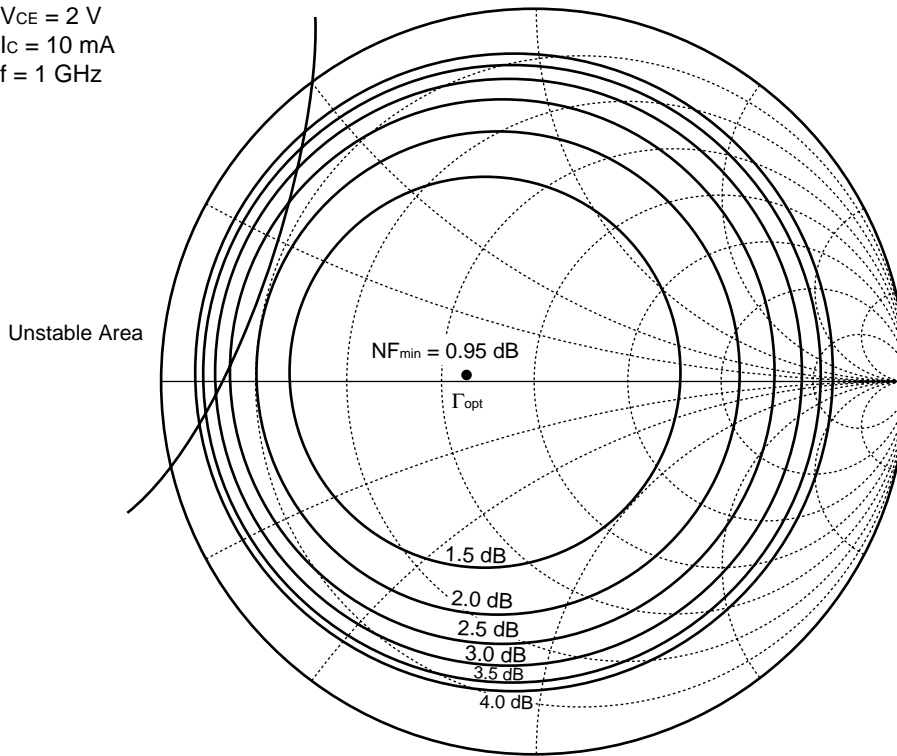

$V_{CE} = 2\text{ V}$
 $I_C = 10\text{ mA}$
 $f = 2\text{ GHz}$

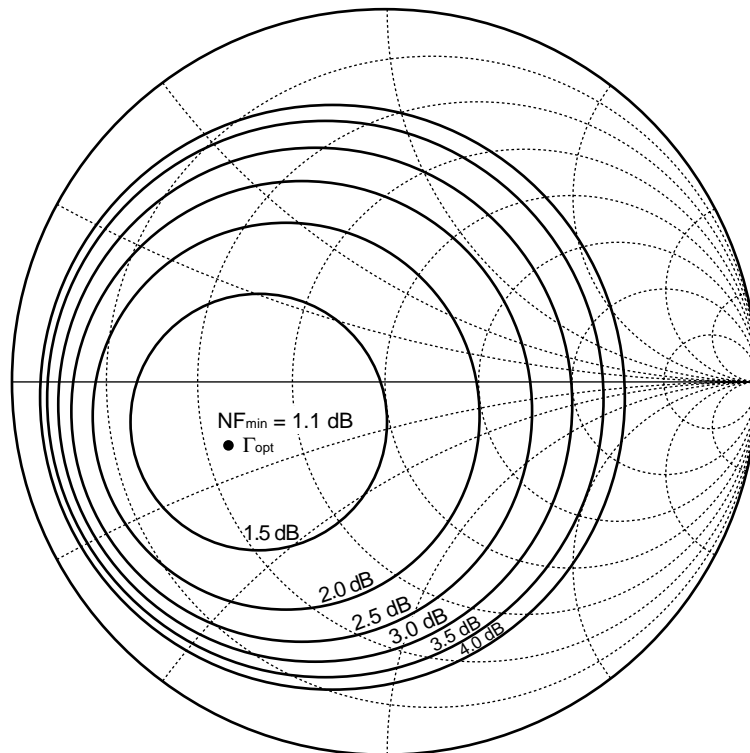

NOISE PARAMETERS

 $V_{CE} = 2\text{ V}$, $I_C = 5\text{ mA}$

f (GHz)	NF _{min} (dB)	G _a (dB)	Γ _{opt}		Rn/50
			MAG.	ANG.	
0.8	0.70	18.0	0.17	93.0	0.11
0.9	0.74	17.0	0.18	103.0	0.11
1.0	0.78	16.2	0.20	112.7	0.11
1.5	0.98	13.6	0.32	155.4	0.09
1.8	1.10	12.5	0.40	176.2	0.07
1.9	1.14	12.2	0.43	-177.8	0.06
2.0	1.18	11.8	0.46	-172.2	0.06
2.5	1.39	9.9	0.56	-151.8	0.08

 $V_{CE} = 2\text{ V}$, $I_C = 20\text{ mA}$

f (GHz)	NF _{min} (dB)	G _a (dB)	Γ _{opt}		Rn/50
			MAG.	ANG.	
0.8	1.12	20.7	0.30	-164.8	0.08
0.9	1.15	19.7	0.31	-162.7	0.09
1.0	1.18	18.8	0.32	-160.7	0.09
1.5	1.31	15.7	0.39	-151.5	0.10
1.8	1.38	14.4	0.45	-146.3	0.10
1.9	1.41	14.0	0.47	-144.6	0.10
2.0	1.43	13.6	0.49	-142.9	0.11
2.5	1.56	11.5	0.56	-133.5	0.14

 $V_{CE} = 2\text{ V}$, $I_C = 10\text{ mA}$

f (GHz)	NF _{min} (dB)	G _a (dB)	Γ _{opt}		Rn/50
			MAG.	ANG.	
0.8	0.87	19.6	0.13	170.3	0.09
0.9	0.90	18.6	0.15	171.5	0.09
1.0	0.93	17.8	0.17	173.0	0.09
1.5	1.07	14.8	0.30	-174.1	0.08
1.8	1.15	13.6	0.39	-164.1	0.07
1.9	1.18	13.2	0.41	-160.6	0.07
2.0	1.20	12.8	0.44	-157.2	0.07
2.5	1.35	10.9	0.53	-142.3	0.10

 $V_{CE} = 2\text{ V}$, $I_C = 50\text{ mA}$

f (GHz)	NF _{min} (dB)	G _a (dB)	Γ _{opt}		Rn/50
			MAG.	ANG.	
0.8	1.75	21.3	0.49	-159.4	0.10
0.9	1.78	20.3	0.49	-157.2	0.10
1.0	1.80	19.4	0.50	-154.9	0.11
1.5	1.92	16.2	0.55	-144.7	0.14
1.8	2.00	14.8	0.59	-139.1	0.17
1.9	2.02	14.4	0.60	-137.3	0.19
2.0	2.04	13.9	0.61	-135.5	0.20
2.5	2.17	11.8	0.65	-126.4	0.28

<R> PACKAGE DIMENSIONS

FLAT-LEAD 4-PIN THIN-TYPE SUPER MINIMOLD (M04) PACKAGE (UNIT: mm)

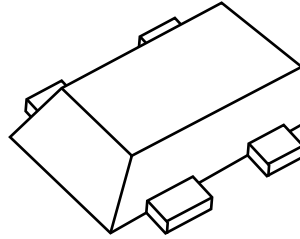

(Top View)

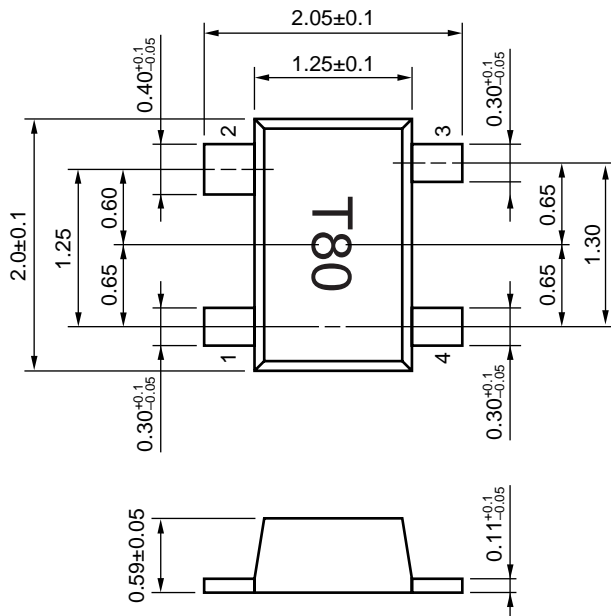

(Bottom View)

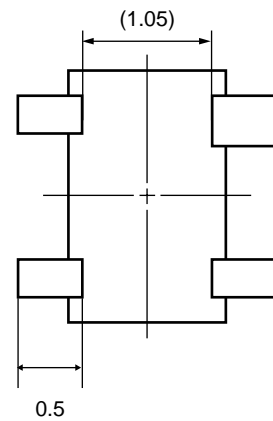

PIN CONNECTIONS

- 1. Emitter
- 2. Collector
- 3. Emitter
- 4. Base

Revision History	2SC5509 Data Sheet
-------------------------	---------------------------

Rev.	Date	Description	
		Page	Summary
1.00	Sep 9, 2004	–	First edition issued
3.00	Mar 5, 2013	Throughout	Renesas format is applied to this data sheet.
		p.1	ORDERING INFORMATION is modified.
		p.5	Up to date S-PARAMETERS.
		p.8	Added a drawing backside to PACKAGE DIMENSIONS.

All trademarks and registered trademarks are the property of their respective owners.

Notice

1. Descriptions of circuits, software and other related information in this document are provided only to illustrate the operation of semiconductor products and application examples. You are fully responsible for the incorporation of these circuits, software, and information in the design of your equipment. Renesas Electronics assumes no responsibility for any losses incurred by you or third parties arising from the use of these circuits, software, or information.
2. Renesas Electronics has used reasonable care in preparing the information included in this document, but Renesas Electronics does not warrant that such information is error free. Renesas Electronics assumes no liability whatsoever for any damages incurred by you resulting from errors in or omissions from the information included herein.
3. Renesas Electronics does not assume any liability for infringement of patents, copyrights, or other intellectual property rights of third parties by or arising from the use of Renesas Electronics products or technical information described in this document. No license, express, implied or otherwise, is granted hereby under any patents, copyrights or other intellectual property rights of Renesas Electronics or others.
4. You should not alter, modify, copy, or otherwise misappropriate any Renesas Electronics product, whether in whole or in part. Renesas Electronics assumes no responsibility for any losses incurred by you or third parties arising from such alteration, modification, copy or otherwise misappropriation of Renesas Electronics product.
5. Renesas Electronics products are classified according to the following two quality grades: "Standard" and "High Quality". The recommended applications for each Renesas Electronics product depends on the product's quality grade, as indicated below.
"Standard": Computers; office equipment; communications equipment; test and measurement equipment; audio and visual equipment; home electronic appliances; machine tools; personal electronic equipment; and industrial robots etc.
"High Quality": Transportation equipment (automobiles, trains, ships, etc.); traffic control systems; anti-disaster systems; anti-crime systems; and safety equipment etc.
Renesas Electronics products are neither intended nor authorized for use in products or systems that may pose a direct threat to human life or bodily injury (artificial life support devices or systems, surgical implantations etc.), or may cause serious property damages (nuclear reactor control systems, military equipment etc.). You must check the quality grade of each Renesas Electronics product before using it in a particular application. You may not use any Renesas Electronics product for any application for which it is not intended. Renesas Electronics shall not be in any way liable for any damages or losses incurred by you or third parties arising from the use of any Renesas Electronics product for which the product is not intended by Renesas Electronics.
6. You should use the Renesas Electronics products described in this document within the range specified by Renesas Electronics, especially with respect to the maximum rating, operating supply voltage range, movement power voltage range, heat radiation characteristics, installation and other product characteristics. Renesas Electronics shall have no liability for malfunctions or damages arising out of the use of Renesas Electronics products beyond such specified ranges.
7. Although Renesas Electronics endeavors to improve the quality and reliability of its products, semiconductor products have specific characteristics such as the occurrence of failure at a certain rate and malfunctions under certain use conditions. Further, Renesas Electronics products are not subject to radiation resistance design. Please be sure to implement safety measures to guard them against the possibility of physical injury, and injury or damage caused by fire in the event of the failure of a Renesas Electronics product, such as safety design for hardware and software including but not limited to redundancy, fire control and malfunction prevention, appropriate treatment for aging degradation or any other appropriate measures. Because the evaluation of microcomputer software alone is very difficult, please evaluate the safety of the final products or systems manufactured by you.
8. Please contact a Renesas Electronics sales office for details as to environmental matters such as the environmental compatibility of each Renesas Electronics product. Please use Renesas Electronics products in compliance with all applicable laws and regulations that regulate the inclusion or use of controlled substances, including without limitation, the EU RoHS Directive. Renesas Electronics assumes no liability for damages or losses occurring as a result of your noncompliance with applicable laws and regulations.
9. Renesas Electronics products and technology may not be used for or incorporated into any products or systems whose manufacture, use, or sale is prohibited under any applicable domestic or foreign laws or regulations. You should not use Renesas Electronics products or technology described in this document for any purpose relating to military applications or use by the military, including but not limited to the development of weapons of mass destruction. When exporting the Renesas Electronics products or technology described in this document, you should comply with the applicable export control laws and regulations and follow the procedures required by such laws and regulations.
10. It is the responsibility of the buyer or distributor of Renesas Electronics products, who distributes, disposes of, or otherwise places the product with a third party, to notify such third party in advance of the contents and conditions set forth in this document, Renesas Electronics assumes no responsibility for any losses incurred by you or third parties as a result of unauthorized use of Renesas Electronics products.
11. This document may not be reproduced or duplicated in any form, in whole or in part, without prior written consent of Renesas Electronics.
12. Please contact a Renesas Electronics sales office if you have any questions regarding the information contained in this document or Renesas Electronics products, or if you have any other inquiries.
(Note 1) "Renesas Electronics" as used in this document means Renesas Electronics Corporation and also includes its majority-owned subsidiaries.
(Note 2) "Renesas Electronics product(s)" means any product developed or manufactured by or for Renesas Electronics.



SALES OFFICES

Renesas Electronics Corporation

<http://www.renesas.com>

Refer to "<http://www.renesas.com/>" for the latest and detailed information.

California Eastern Laboratories, Inc.
4590 Patrick Henry Drive, Santa Clara, California 95054, U.S.A.
Tel: +1-408-919-2500, Fax: +1-408-988-0279

Renesas Electronics Europe Limited
Dukes Meadow, Millboard Road, Bourne End, Buckinghamshire, SL8 5FH, U.K
Tel: +44-1628-651-700, Fax: +44-1628-651-804

Renesas Electronics Europe GmbH
Arcadiastrasse 10, 40472 Düsseldorf, Germany
Tel: +49-211-65030, Fax: +49-211-6503-1327

Renesas Electronics (China) Co., Ltd.
7th Floor, Quantum Plaza, No.27 ZhiChunLu Haidian District, Beijing 100083, P.R.China
Tel: +86-10-8235-1155, Fax: +86-10-8235-7679

Renesas Electronics (Shanghai) Co., Ltd.
Unit 204, 205, AZIA Center, No.1233 Lujiazui Ring Rd., Pudong District, Shanghai 200120, China
Tel: +86-21-5877-1818, Fax: +86-21-6887-7858 / -7898

Renesas Electronics Hong Kong Limited
Unit 1601-1613, 16/F., Tower 2, Grand Century Place, 193 Prince Edward Road West, Mongkok, Kowloon, Hong Kong
Tel: +852-2886-9318, Fax: +852 2886-9022/9044

Renesas Electronics Taiwan Co., Ltd.
13F, No. 363, Fu Shing North Road, Taipei, Taiwan
Tel: +886-2-8175-9600, Fax: +886 2-8175-9670

Renesas Electronics Singapore Pte. Ltd.
80 Bendemeer Road, Unit #06-02 Hyflux Innovation Centre Singapore 339949
Tel: +65-6213-0200, Fax: +65-6213-0300

Renesas Electronics Malaysia Sdn.Bhd.
Unit 906, Block B, Menara Amcorp, Amcorp Trade Centre, No. 18, Jln Persiaran Barat, 46050 Petaling Jaya, Selangor Darul Ehsan, Malaysia
Tel: +60-3-7955-9390, Fax: +60-3-7955-9510

Renesas Electronics Korea Co., Ltd.
11F., Samik Lavied' or Bldg., 720-2 Yeoksam-Dong, Kangnam-Ku, Seoul 135-080, Korea
Tel: +82-2-558-3737, Fax: +82-2-558-5141

Компания «Океан Электроники» предлагает заключение долгосрочных отношений при поставках импортных электронных компонентов на взаимовыгодных условиях!

Наши преимущества:

- Поставка оригинальных импортных электронных компонентов напрямую с производств Америки, Европы и Азии, а так же с крупнейших складов мира;
- Широкая линейка поставок активных и пассивных импортных электронных компонентов (более 30 млн. наименований);
- Поставка сложных, дефицитных, либо снятых с производства позиций;
- Оперативные сроки поставки под заказ (от 5 рабочих дней);
- Экспресс доставка в любую точку России;
- Помощь Конструкторского Отдела и консультации квалифицированных инженеров;
- Техническая поддержка проекта, помощь в подборе аналогов, поставка прототипов;
- Поставка электронных компонентов под контролем ВП;
- Система менеджмента качества сертифицирована по Международному стандарту ISO 9001;
- При необходимости вся продукция военного и аэрокосмического назначения проходит испытания и сертификацию в лаборатории (по согласованию с заказчиком);
- Поставка специализированных компонентов военного и аэрокосмического уровня качества (Xilinx, Altera, Analog Devices, Intersil, Interpoint, Microsemi, Actel, Aeroflex, Peregrine, VPT, Syfer, Eurofarad, Texas Instruments, MS Kennedy, Miteq, Cobham, E2V, MA-COM, Hittite, Mini-Circuits, General Dynamics и др.);

Компания «Океан Электроники» является официальным дистрибьютором и эксклюзивным представителем в России одного из крупнейших производителей разъемов военного и аэрокосмического назначения «JONHON», а так же официальным дистрибьютором и эксклюзивным представителем в России производителя высокотехнологичных и надежных решений для передачи СВЧ сигналов «FORSTAR».



JONHON

«JONHON» (основан в 1970 г.)

Разъемы специального, военного и аэрокосмического назначения:

(Применяются в военной, авиационной, аэрокосмической, морской, железнодорожной, горно- и нефтедобывающей отраслях промышленности)

«FORSTAR» (основан в 1998 г.)

ВЧ соединители, коаксиальные кабели, кабельные сборки и микроволновые компоненты:

(Применяются в телекоммуникациях гражданского и специального назначения, в средствах связи, РЛС, а так же военной, авиационной и аэрокосмической отраслях промышленности).



Телефон: 8 (812) 309-75-97 (многоканальный)

Факс: 8 (812) 320-03-32

Электронная почта: ocean@oceanchips.ru

Web: <http://oceanchips.ru/>

Адрес: 198099, г. Санкт-Петербург, ул. Калинина, д. 2, корп. 4, лит. А