



**Hittite**  
MICROWAVE PRODUCTS  
FROM ANALOG DEVICES

# Analog Devices Welcomes Hittite Microwave Corporation



**THIS PAGE INTENTIONALLY LEFT BLANK**

## GaAs MMIC 3 WATT T/R SWITCH DC - 3 GHz

### Typical Applications

The HMC595A / 595AE is ideal for:

- Cellular/3G Infrastructure
- Private Mobile Radio Handsets
- WLAN, WiMAX & WiBro
- Automotive Telematics
- Test Equipment

### Functional Diagram

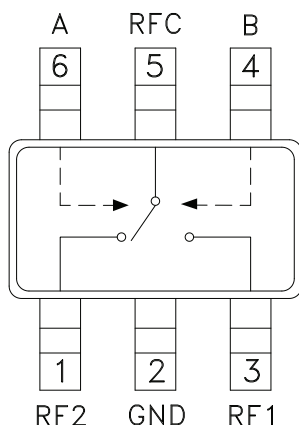

### Features

- Low Insertion Loss: 0.3 dB
- High Input IP3: +63 dBm
- Isolation: 30 dB
- Positive Control: 0/+3V to 0/+10V
- Ultra Small Package: SOT26

### General Description

The HMC595A & HMC595AE are low-cost SPDT switches in 6-lead SOT26 packages for use in transmit/receive applications which require very low distortion at high incident power levels. The device can control signals from DC to 3 GHz and is especially suited for Cellular/3G infrastructure, WiMAX and WiBro applications with only 0.3 dB typical insertion loss. The design provides a 3 watt power handling and +63 dBm third order intercept at +8 Volt bias. RF1 and RF2 are reflective shorts when "Off". Control inputs A & B are compatible with CMOS and some TTL logic families. These products are form, fit and function replacements for HMC595 & HMC595E while offering superior electrical performance.

### Electrical Specifications,

$T_A = +25^\circ \text{C}$ ,  $V_{ctl} = 0/+5 \text{Vdc}$  (Unless Otherwise Stated), 50 Ohm System

| Parameter   | Frequency     | Min.                                     | Typ. | Max. | Units |
|---|---------------|--|------|------|-------|
| Insertion Loss  | DC - 1.0 GHz  |  | 0.25 | 0.5  | dB    |
|   | DC - 2.0 GHz  |  | 0.3  | 0.6  | dB    |
|   | DC - 2.5 GHz  |  | 0.4  | 0.7  | dB    |
|   | DC - 3.0 GHz  |  | 0.5  | 0.8  | dB    |
| Isolation   | DC - 1.0 GHz  | 26                                       | 30   |      | dB    |
|   | DC - 2.0 GHz  | 22                                       | 26   |      | dB    |
|   | DC - 2.5 GHz  | 18                                       | 24   |      | dB    |
|   | DC - 3.0 GHz  | 14                                       | 18   |      | dB    |
| Return Loss   | DC - 1.0 GHz  |  | 30   |      | dB    |
|   | DC - 2.0 GHz  |  | 25   |      | dB    |
|   | DC - 2.5 GHz  |  | 22   |      | dB    |
|   | DC - 3.0 GHz  |  | 20   |      | dB    |
| Input Power for 1dB Compression   | 0.5 - 3.0 GHz | $V_{ctl} = 0/+3V$                        | 29   | 31   | dBm   |
|   |               | $V_{ctl} = 0/+5V$                        | 35   | 37   | dBm   |
|   |               | $V_{ctl} = 0/+8V$                        | 37   | 39   | dBm   |
| Input Third Order Intercept<br>(Two-tone Input Power = +23 dBm Each Tone) | 0.5 - 3.0 GHz | $V_{ctl} = 0/+3V$                        |      | 50   | dBm   |
|   |               | $V_{ctl} = 0/+5V$                        |      | 64   | dBm   |
|   |               | $V_{ctl} = 0/+8V$                        |      | 63   | dBm   |
| Switching Characteristics   | DC - 3.0 GHz  | $t_{RISE}, t_{FALL}$ (10/90% RF)         |      | 50   | ns    |
|   |               | $t_{ON}, t_{OFF}$ (50% CTL to 10/90% RF) |      | 100  | ns    |

For price, delivery and to place orders: Hittite Microwave Corporation, 2 Elizabeth Drive, Chelmsford, MA 01824

Phone: 978-250-3343 Fax: 978-250-3373 Order On-line at [www.hittite.com](http://www.hittite.com)

Application Support: Phone: 978-250-3343 or [apps@hittite.com](mailto:apps@hittite.com)



**GaAs MMIC 3 WATT T/R SWITCH  
 DC - 3 GHz**

**Insertion Loss**

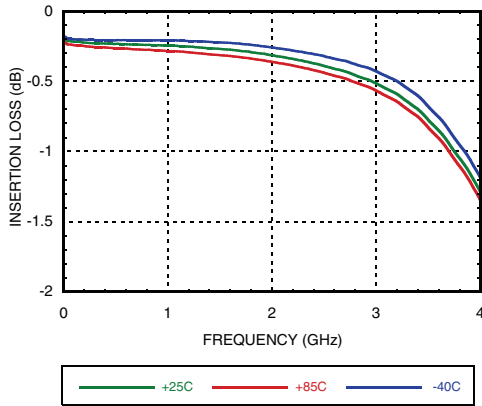

**Isolation Between RFC and RF1/RF2**

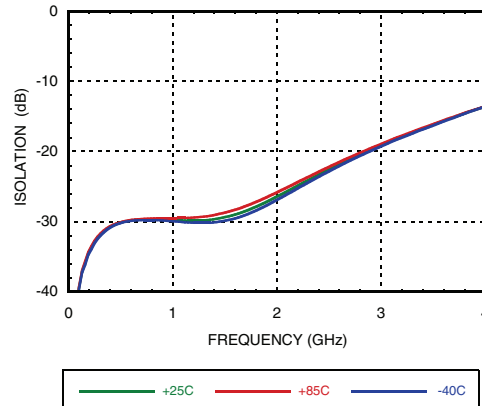

**RF1 to RF2 Isolations**

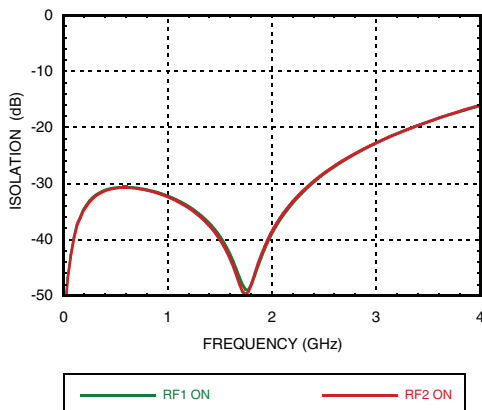

**Return Loss**

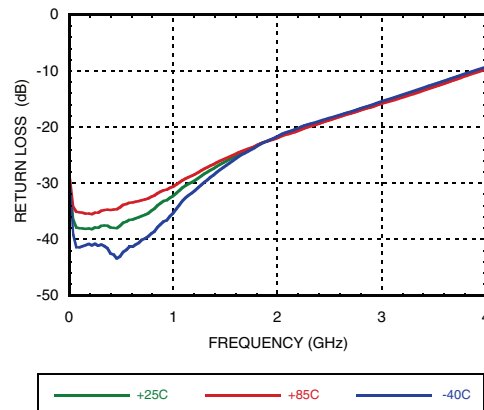

**Input P0.1dB vs. Vctl**

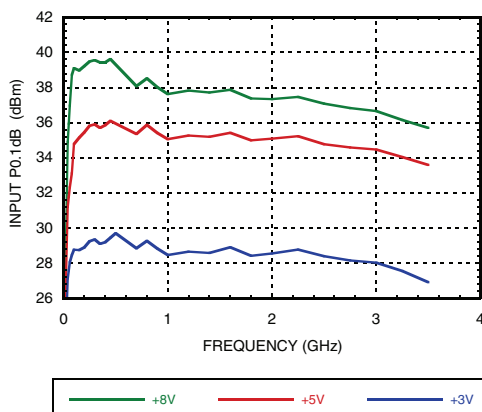

**Input P1dB vs. Vctl**

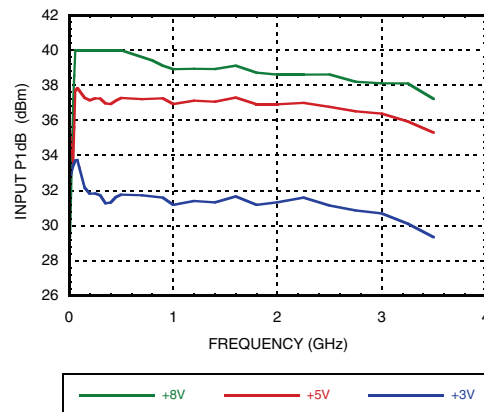



**GaAs MMIC 3 WATT T/R SWITCH  
 DC - 3 GHz**

SWITCHES - SPDT T/R - SMT

**Input IP3 vs. Input Power @ 900 MHz**

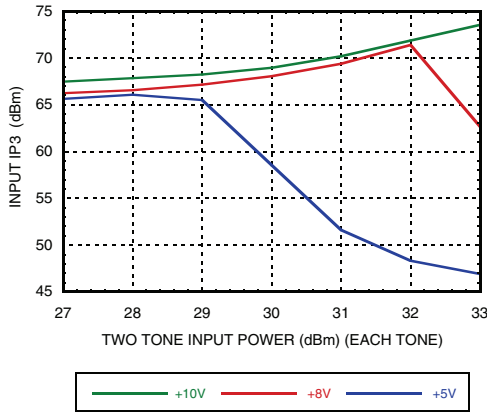

**Input IP3 vs. Input Power @ 1900 MHz**

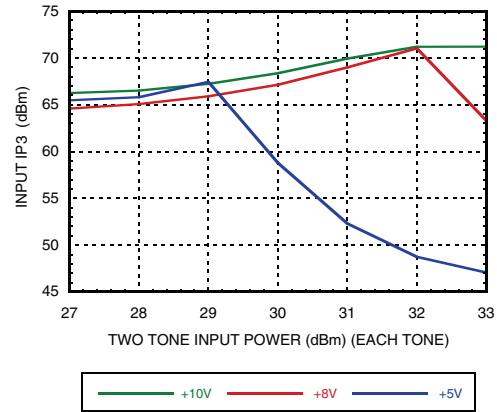

**Input Third Order Intercept Point**

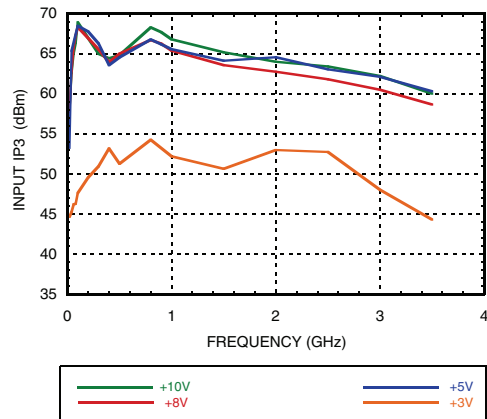

**2nd & 3rd Harmonics @ 900 MHz  
 Vctl = +3 Volts**

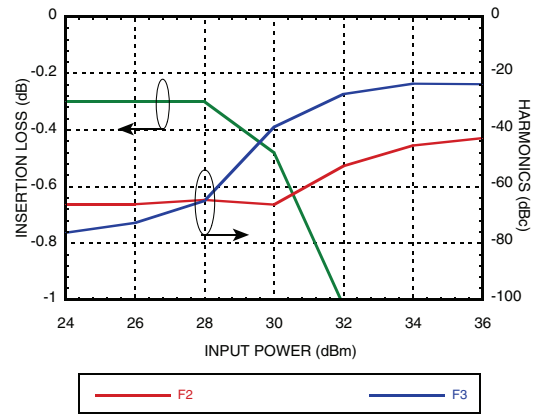

**2nd & 3rd Harmonics @ 900 MHz  
 Vctl = +5 Volts**

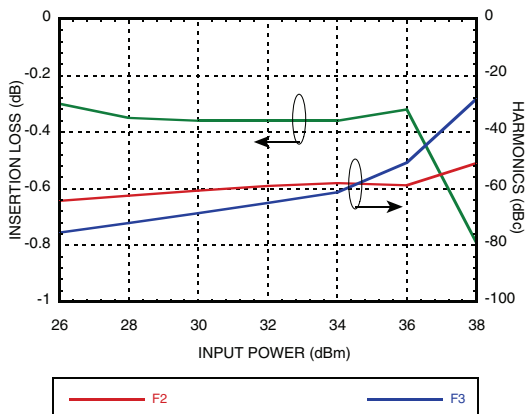

**2nd & 3rd Harmonics @ 900 MHz  
 Vctl = +8 Volts**

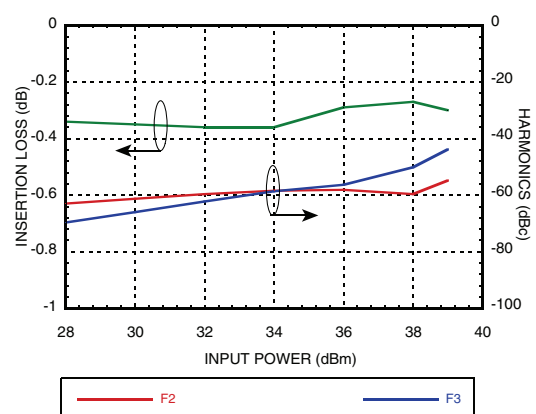



**GaAs MMIC 3 WATT T/R SWITCH  
DC - 3 GHz**

**Input P0.1dB vs. Vctl**

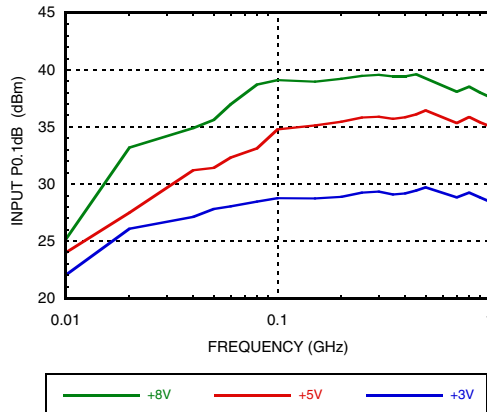

**Input P1dB vs. Vctl**

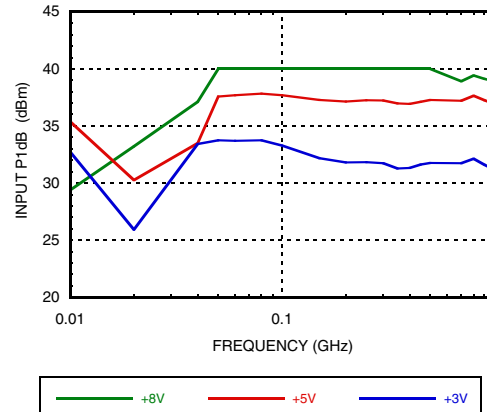

**Absolute Maximum Ratings**

|  |                 |        |
|--|-----------------|--------|
| Max. Input Power<br>$V_{ctl} = 0/+8V$  | 0.5 - 2.5 GHz   | 39 dBm |
| Control Voltage Range (A & B)  | -0.2 to +12 Vdc |        |
| Channel Temperature  | 150 °C          |        |
| Continuous P <sub>diss</sub> ( T= + 85 °C)<br>(derate 9.2 mW/°C above 85 °C) | 0.597W          |        |
| Thermal Resistance   | 109 °C/W        |        |
| Storage Temperature  | -65 to +150 °C  |        |
| Operating Temperature  | -40 to +85 °C   |        |
| ESD Sensitivity (HBM)  | Class 1A        |        |

DC Blocks are required at ports RFC, RF1 and RF2

**Control Voltages**

| State | Bias Condition   |
|-------|--|
| Low   | 0 to +0.2 Vdc @ 10 $\mu$ A Typical   |
| High  | +3 Vdc @ 2 $\mu$ A Typical to<br>+8 Vdc @ 100 $\mu$ A Typical ( $\pm$ 0.2 Vdc) |

**Truth Table**

| Control Input (Vctl) |      | Signal Path State |            |
|----------------------|------|-------------------|------------|
| A                    | B    | RFC to RF1        | RFC to RF2 |
| High                 | Low  | Off               | On         |
| Low                  | High | On                | Off        |



**ELECTROSTATIC SENSITIVE DEVICE  
OBSERVE HANDLING PRECAUTIONS**

**Outline Drawing**

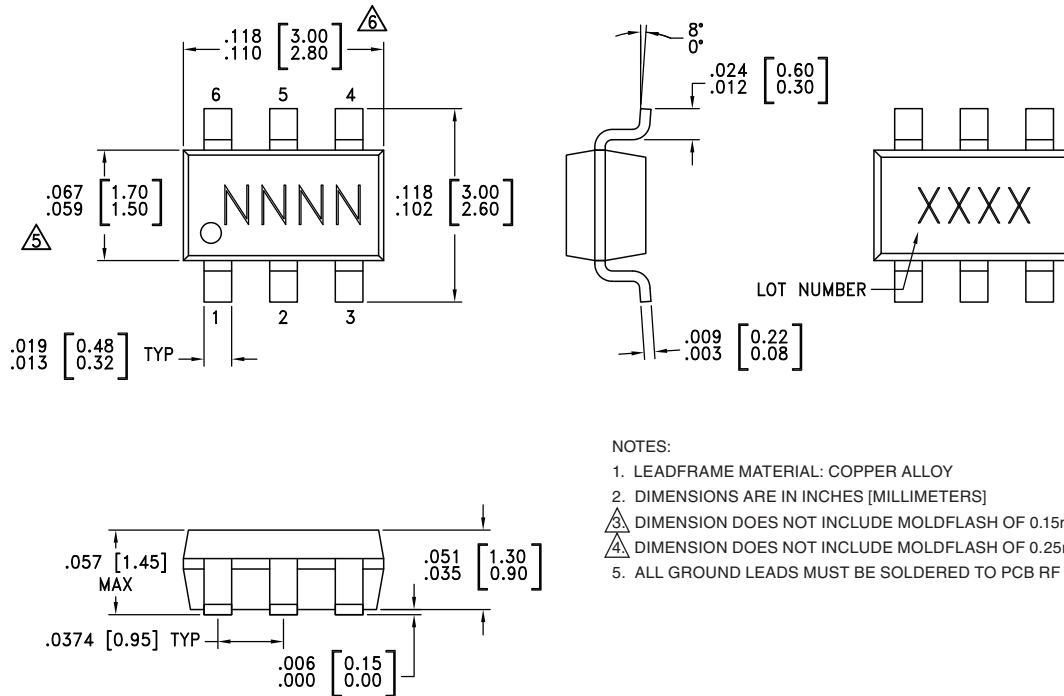

NOTES:

1. LEADFRAME MATERIAL: COPPER ALLOY
2. DIMENSIONS ARE IN INCHES [MILLIMETERS]
3. DIMENSION DOES NOT INCLUDE MOLDFLASH OF 0.15mm PER SIDE.
4. DIMENSION DOES NOT INCLUDE MOLDFLASH OF 0.25mm PER SIDE.
5. ALL GROUND LEADS MUST BE SOLDERED TO PCB RF GROUND

**Package Information**

| Part Number | Package Body Material                              | Lead Finish   | MSL Rating          | Package Marking <sup>[3]</sup> |
|-------------|--|---------------|---------------------|--------------------------------|
| HMC595A     | Low Stress Injection Molded Plastic                | Sn/Pb Solder  | MSL1 <sup>[1]</sup> | H595A<br>XXXX                  |
| HMC595AE    | RoHS-compliant Low Stress Injection Molded Plastic | 100% matte Sn | MSL1 <sup>[2]</sup> | 595AE<br>XXXX                  |

[1] Max peak reflow temperature of 235 °C  
 [2] Max peak reflow temperature of 260 °C  
 [3] 4-Digit lot number XXXX

**Pin Descriptions**

| Pin Number | Function      | Description   | Interface Schematic |
|------------|---------------|---|---------------------|
| 1, 3, 5    | RF2, RF1, RFC | This pin is DC coupled and matched to 50 Ohm. Blocking capacitors are required. |                     |
| 2          | GND           | This pin must be connected to RF/DC ground.                                     |                     |
| 4          | B             | See truth table and control voltage table.                                      |                     |
| 6          | A             | See truth table and control voltage table.                                      |                     |

### Typical Application Circuit

Notes:

1. Set logic gate and switch Vdd = +3V to +5V and use HCT series logic to provide a TTL driver interface.
2. Control inputs A/B can be driven directly with CMOS logic (HC) with Vdd of +3 to +8 Volts applied to the CMOS logic gates.
3. DC Blocking capacitors are required for each RF port as shown. Capacitor value determines lowest frequency of operation.
4. Highest RF signal power capability is achieved with V set to +10V. The switch will operate properly (but at lower RF power capability) at bias voltages down to +3V.

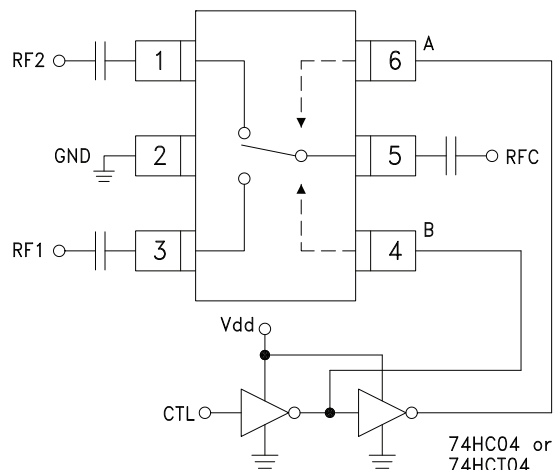

### Evaluation Circuit Board

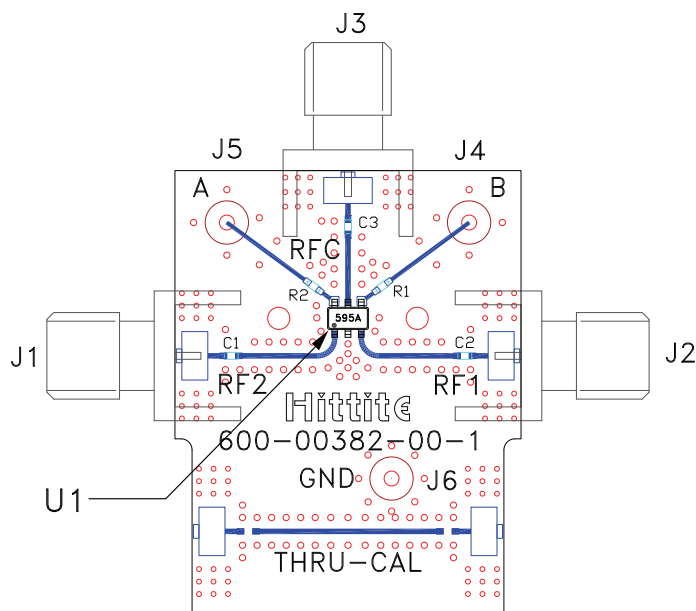

### List of Materials for Evaluation PCB EV1HMC595A [1]

| Item    | Description                 |
|---------|-----------------------------|
| J1 - J3 | PCB Mount SMA RF Connector  |
| J4 - J6 | DC Pin                      |
| C1 - C3 | 330 pF capacitor, 0402 Pkg. |
| R1, R2  | 1 kOhm Resistor, 0402 Pkg.  |
| U1      | HMC595A / 595AE T/R Switch  |
| PCB [2] | 101659 Evaluation PCB       |

[1] Reference this number when ordering complete evaluation PCB

[2] Circuit Board Material: Rogers 4350

The circuit board used in the application should be generated with proper RF circuit design techniques. Signal lines at the RF port should have 50 Ohm impedance and the package ground leads and package bottom should be connected directly to the ground plane similar to that shown above. The evaluation circuit board shown above is available from Analog Devices upon request.



Компания «Океан Электроники» предлагает заключение долгосрочных отношений при поставках импортных электронных компонентов на взаимовыгодных условиях!

Наши преимущества:

- Поставка оригинальных импортных электронных компонентов напрямую с производств Америки, Европы и Азии, а так же с крупнейших складов мира;
- Широкая линейка поставок активных и пассивных импортных электронных компонентов (более 30 млн. наименований);
- Поставка сложных, дефицитных, либо снятых с производства позиций;
- Оперативные сроки поставки под заказ (от 5 рабочих дней);
- Экспресс доставка в любую точку России;
- Помощь Конструкторского Отдела и консультации квалифицированных инженеров;
- Техническая поддержка проекта, помощь в подборе аналогов, поставка прототипов;
- Поставка электронных компонентов под контролем ВП;
- Система менеджмента качества сертифицирована по Международному стандарту ISO 9001;
- При необходимости вся продукция военного и аэрокосмического назначения проходит испытания и сертификацию в лаборатории (по согласованию с заказчиком);
- Поставка специализированных компонентов военного и аэрокосмического уровня качества (Xilinx, Altera, Analog Devices, Intersil, Interpoint, Microsemi, Actel, Aeroflex, Peregrine, VPT, Syfer, Eurofarad, Texas Instruments, MS Kennedy, Miteq, Cobham, E2V, MA-COM, Hittite, Mini-Circuits, General Dynamics и др.);

Компания «Океан Электроники» является официальным дистрибьютором и эксклюзивным представителем в России одного из крупнейших производителей разъемов военного и аэрокосмического назначения «JONHON», а так же официальным дистрибьютором и эксклюзивным представителем в России производителя высокотехнологичных и надежных решений для передачи СВЧ сигналов «FORSTAR».



## JONHON

«JONHON» (основан в 1970 г.)

Разъемы специального, военного и аэрокосмического назначения:

(Применяются в военной, авиационной, аэрокосмической, морской, железнодорожной, горно- и нефтедобывающей отраслях промышленности)

«FORSTAR» (основан в 1998 г.)

ВЧ соединители, коаксиальные кабели, кабельные сборки и микроволновые компоненты:

(Применяются в телекоммуникациях гражданского и специального назначения, в средствах связи, РЛС, а так же военной, авиационной и аэрокосмической отраслях промышленности).



Телефон: 8 (812) 309-75-97 (многоканальный)

Факс: 8 (812) 320-03-32

Электронная почта: [ocean@oceanchips.ru](mailto:ocean@oceanchips.ru)

Web: <http://oceanchips.ru/>

Адрес: 198099, г. Санкт-Петербург, ул. Калинина, д. 2, корп. 4, лит. А