

Product Summary

- Continuous Drain Source Voltage: 60V
- On-State Resistance: 500mΩ
- Nominal Load Current ($V_{IN} = 5V$): 1.3A
- Clamping Energy: 90mJ

Description

The ZXMS6004FFQ is a self-protected low side IntelliFET™ MOSFET with logic level input. It integrates overtemperature, overcurrent, overvoltage (active clamp) and ESD protected logic level functionality. The ZXMS6004FFQ is ideal as a general purpose switch driven from 3.3V or 5V microcontrollers in harsh environments where standard MOSFETs are not rugged enough.

Applications

- Especially Suited for Loads with a High In-Rush Current such as Lamps and Motors
- All Types of Resistive, Inductive and Capacitive Loads in Switching Applications
- μ C Compatible Power Switch for 12V and 24V DC Applications
- Automotive Rated
- Replaces Electromechanical Relays and Discrete Circuits
- Linear Mode Capability – the current-limiting protection circuitry is designed to de-activate at low V_{DS} to minimize on state power dissipation. The maximum DC operating current is therefore determined by the thermal capability of the package/board combination, rather than by the protection circuitry. This does not compromise the product's ability to self-protect at low V_{DS} .

SOT23F



Top View

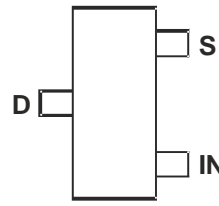

Top view
Pin Out

Features and Benefits

- Compact High Power Dissipation Package
- Low Input Current
- Logic Level Input (3.3V and 5V)
- Short Circuit Protection with Auto Restart
- Overvoltage Protection (Active Clamp)
- Thermal Shutdown with Auto Restart
- Overcurrent Protection
- Input Protection (ESD)
- High Continuous Current Rating
- **Totally Lead-Free & Fully RoHS Compliant (Notes 1 & 2)**
- **Halogen and Antimony Free. "Green" Device (Note 3)**
- **Qualified to AEC-Q101 Standards for High Reliability**
- **PPAP Capable (Note 4)**

Mechanical Data

- Case: SOT23F
- Case Material: Molded Plastic, "Green" Molding Compound. UL Flammability Classification Rating 94V-0
- Moisture Sensitivity: Level 1 per J-STD-020
- Terminals: Matte Tin Finish Ⓜ
- Weight: 0.012 grams (Approximate)

Ordering Information (Note 5)

| Product | Marking | Reel Size (inches) | Tape Width (mm) | Quantity per Reel |
|---------------|---------|--------------------|-----------------|-------------------|
| ZXMS6004FFQTA | 1K6 | 7 | 12 | 3,000 |

- Notes:
1. No purposely added lead. Fully EU Directive 2002/95/EC (RoHS) & 2011/65/EU (RoHS 2) compliant.
 2. See http://www.diodes.com/quality/lead_free.html for more information about Diodes Incorporated's definitions of Halogen- and Antimony-free, "Green" and Lead-free.
 3. Halogen- and Antimony-free "Green" products are defined as those which contain <900ppm bromine, <900ppm chlorine (<1500ppm total Br + Cl) and <1000ppm antimony compounds.
 4. Automotive products are AEC-Q10x qualified and are PPAP capable. Refer to http://www.diodes.com/quality/product_compliance_definitions/.
 5. For packaging details, go to our website at <http://www.diodes.com/products/packages.html>.

Marking Information

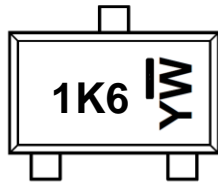

Y: Year: 0~9
 W: Week: A-Z : 1~26
 a-z: 27~52
 z: Represents 52 & 53 Week
 1K6 = Product Type Marking Code

Functional Block Diagram

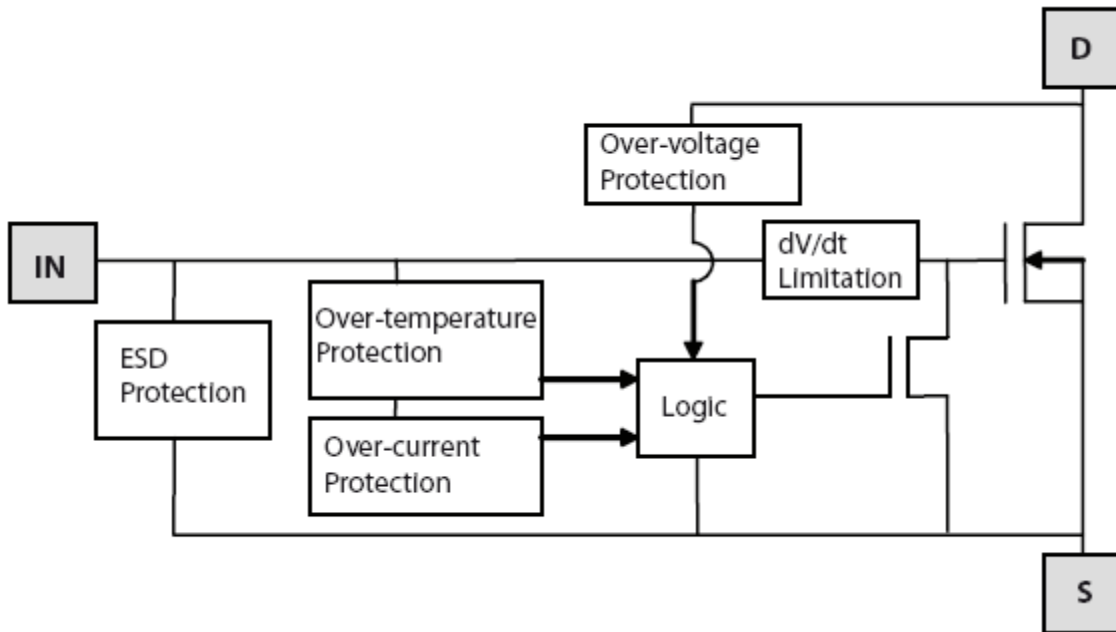

Maximum Ratings (@T_A = +25°C, unless otherwise specified.)

| Characteristic | Symbol | Value | Units |
|--|---------------------|-----------------------|-------|
| Continuous Drain-Source Voltage | V _{DS} | 60 | V |
| Drain-Source Voltage for Short Circuit Protection | V _{DS(SC)} | 36 | V |
| Continuous Input Voltage | V _{IN} | -0.5 ... +6 | V |
| Continuous Input Current @ -0.2V ≤ V _{IN} ≤ 6V | I _{IN} | No limit | mA |
| Continuous Input Current @ V _{IN} < -0.2V or V _{IN} > 6V | | I _{IN} ≤ 2 | |
| Pulsed Drain Current @ V _{IN} = 3.3V | I _{DM} | 2 | A |
| Pulsed Drain Current @ V _{IN} = 5V | I _{DM} | 2.5 | A |
| Continuous Source Current (Body Diode) | I _S | 1 | A |
| Pulsed Source Current (Body Diode) | I _{SM} | 5 | A |
| Unclamped Single Pulse Inductive Energy, T _J = +25°C, I _D = 0.5A, V _{DD} = 24V | E _{AS} | 90 | mJ |
| Electrostatic Discharge (Human Body Model) | V _{ESD} | 4,000 | V |
| Charged Device Model | V _{CDM} | 1,000 | V |

Thermal Characteristics (@T_A = +25°C, unless otherwise specified.)

| Characteristic | Symbol | Value | Units |
|---|------------------|-------------|-------|
| Power Dissipation @ T _A = +25°C (Note 6) | P _D | 0.83 | W |
| Linear Derating Factor | | 6.66 | mW/°C |
| Power Dissipation @ T _A = +25°C (Note 7) | P _D | 1.5 | W |
| Linear Derating Factor | | 12.0 | mW/°C |
| Thermal Resistance, Junction to Ambient (Note 6) | R _{θJA} | 150 | °C/W |
| Thermal Resistance, Junction to Ambient (Note 7) | R _{θJA} | 83 | °C/W |
| Thermal Resistance, Junction to Case (Note 8) | R _{θJC} | 44 | °C/W |
| Operating Temperature Range | T _J | -40 to +150 | °C |
| Storage Temperature Range | T _{STG} | -55 to +150 | °C |

Notes: 6. For a device surface mounted on 15mm x 15mm single sided, 1oz weight copper on 1.6mm FR4 board, in still air conditions.

7. For a device surface mounted on 50mm x 50mm single sided, 2oz weight copper on 1.6mm FR4 board, in still air conditions.

8. Thermal resistance from junction and the mounting surfaces of the drain pins.

Recommended Operating Conditions

The ZXMS6004FF is optimized for use with μC operating from 3.3V and 5V supplies.

| Characteristic | Symbol | Min | Max | Unit |
|---|-----------------|-----|------|------|
| Input Voltage Range | V _{IN} | 0 | 5.5 | V |
| Ambient Temperature Range | T _A | -40 | +125 | °C |
| High Level Input Voltage for MOSFET to be On | V _{IH} | 3 | 5.5 | V |
| Low Level Input Voltage for MOSFET to be Off | V _{IL} | 0 | 0.7 | V |
| Peripheral Supply Voltage (Voltage to which Load is Referred) | V _P | 0 | 36 | V |

Typical Thermal Characteristics

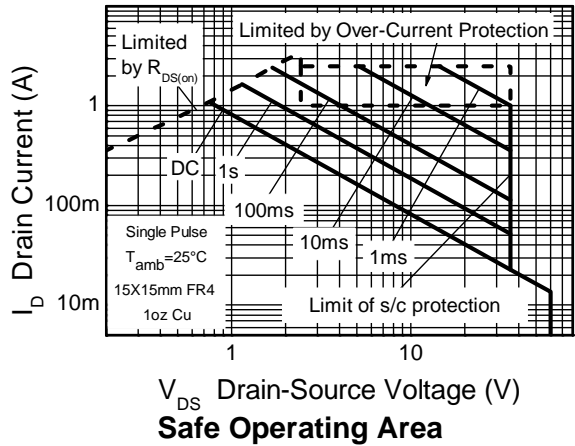

Safe Operating Area

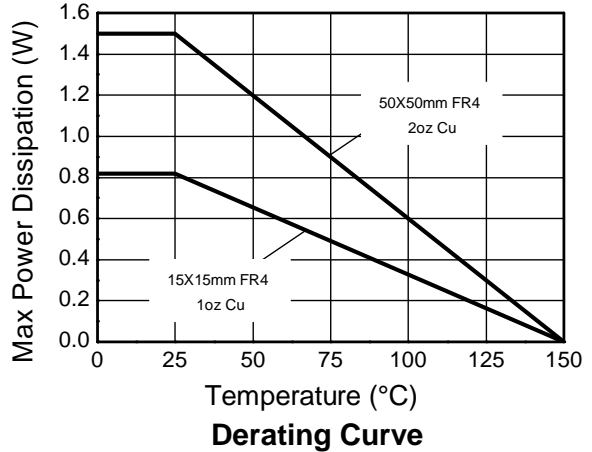

Derating Curve

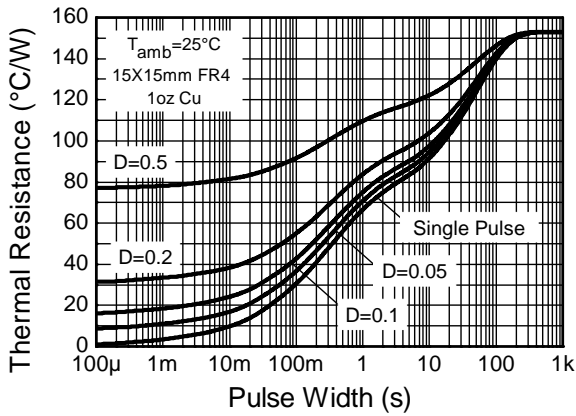

Transient Thermal Impedance

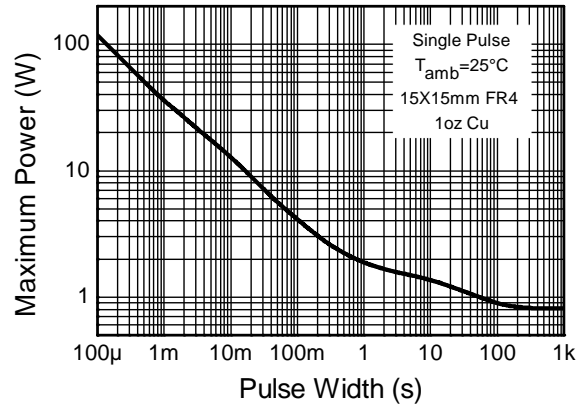

Pulse Power Dissipation

Electrical Characteristics (@T_A = +25°C, unless otherwise specified.)

| Characteristic | Symbol | Min | Typ | Max | Unit | Test Condition |
|---|---------------------|------|------|-----|------|--|
| Static Characteristics | | | | | | |
| Drain-Source Clamp Voltage | V _{DS(AZ)} | 60 | 65 | 70 | V | I _D = 10mA |
| Off-State Drain Current | I _{DSS} | — | — | 500 | nA | V _{DS} = 12V, V _{IN} = 0V |
| | | — | — | 1 | μA | V _{DS} = 36V, V _{IN} = 0V |
| Input Threshold Voltage | V _{IN(TH)} | 0.7 | 1 | 1.5 | V | V _{DS} = V _{GS} , I _D = 1mA |
| Input Current | I _{IN} | — | 60 | 100 | μA | V _{IN} = +3V |
| | | — | 120 | 200 | | V _{IN} = +5V |
| Input Current while Overtemperature Active | — | — | — | 220 | μA | V _{IN} = +5V |
| Static Drain-Source On-State Resistance | R _{DS(ON)} | — | 400 | 600 | mΩ | V _{IN} = +3V, I _D = 0.5A |
| | | — | 350 | 500 | | V _{IN} = +5V, I _D = 0.5A |
| Continuous Drain Current (Note 6) | I _D | 0.9 | — | — | A | V _{IN} = 3V; T _A = +25°C |
| | | 1.0 | — | — | | V _{IN} = 5V; T _A = +25°C |
| Continuous Drain Current (Note 7) | | 1.2 | — | — | | V _{IN} = 3V; T _A = +25°C |
| | | 1.3 | — | — | | V _{IN} = 5V; T _A = +25°C |
| Current Limit (Note 9) | I _{D(LIM)} | 0.7 | 1.7 | — | A | V _{IN} = +3V |
| | | 1 | 2.2 | — | | V _{IN} = +5V |
| Dynamic Characteristics | | | | | | |
| Turn-On Delay Time | t _{D(ON)} | — | 5 | — | μs | V _{DD} = 12V, I _D = 0.5A, V _{GS} = 5V |
| Rise Time | t _R | — | 10 | — | | |
| Turn-Off Delay Time | t _{D(OFF)} | — | 45 | — | | |
| Fall Time | t _F | — | 15 | — | | |
| Overtemperature Protection | | | | | | |
| Thermal Overload Trip Temperature (Note 10) | T _{JT} | +150 | +175 | — | °C | — |
| Thermal Hysteresis (Note 10) | f _F | — | +10 | — | °C | — |

- Notes:
- The drain current is restricted only when the device is in saturation (see graph 'Typical Output Characteristic'). This allows the device to be used in the fully on-state without interference from the current limit. The device is fully protected at all drain currents, as the low power dissipation generated outside saturation makes current limit unnecessary.
 - Overtemperature protection is designed to prevent device destruction under fault conditions. Fault conditions are considered as "outside" normal operating range, so this part is not designed to withstand over-temperature for extended periods.

Typical Performance Characteristics

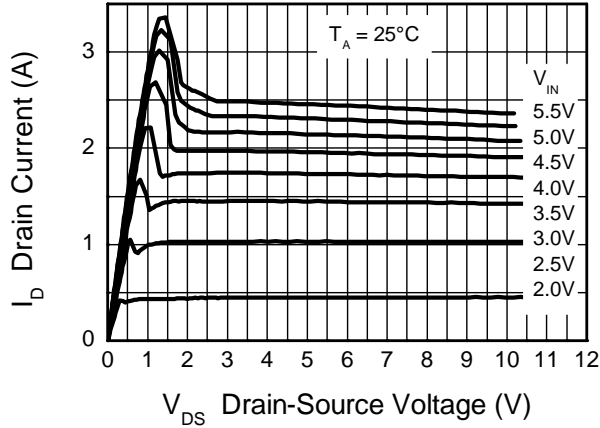

Typical Output Characteristic

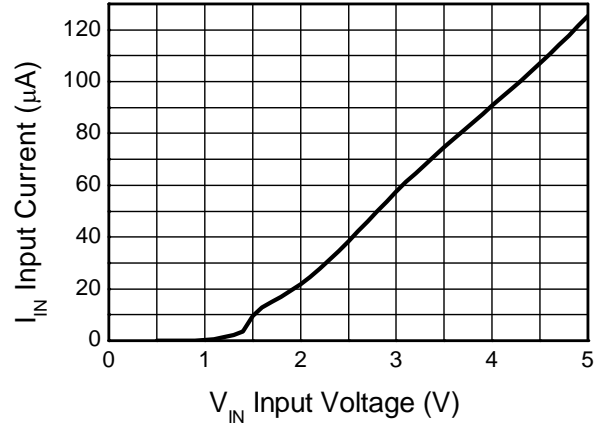

Input Current vs Input Voltage

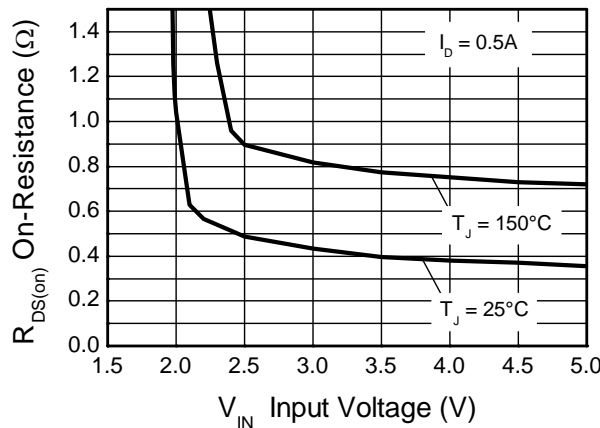

On-Resistance vs Input Voltage

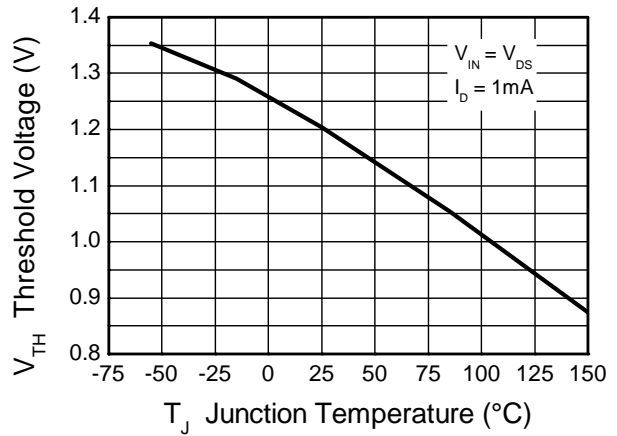

Threshold Voltage vs Temperature

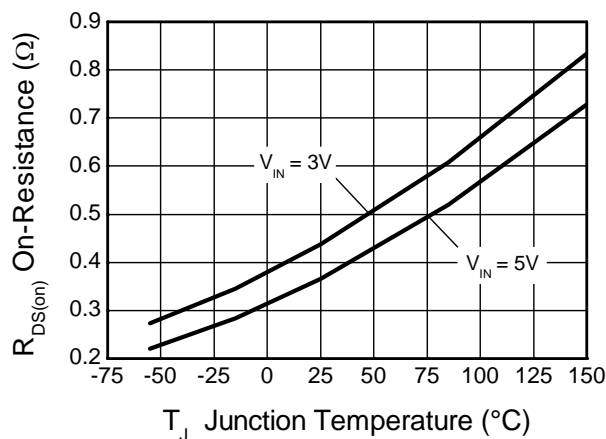

On-Resistance vs Temperature

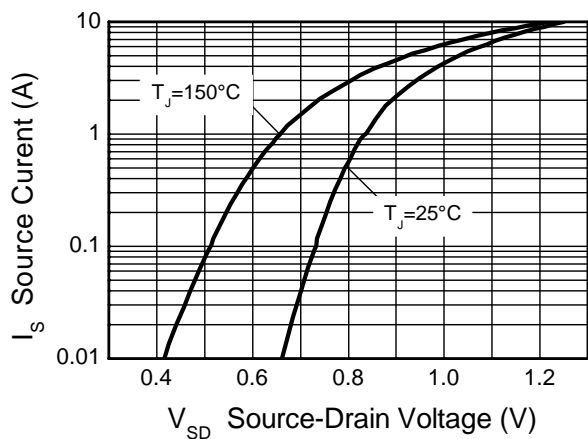

Reverse Diode Characteristic

Typical Performance Characteristics (continued)

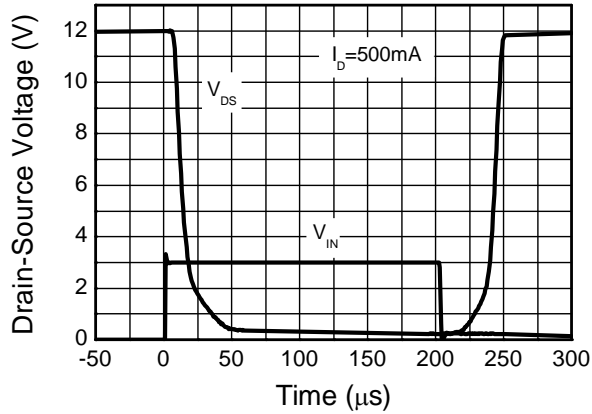

Switching Speed

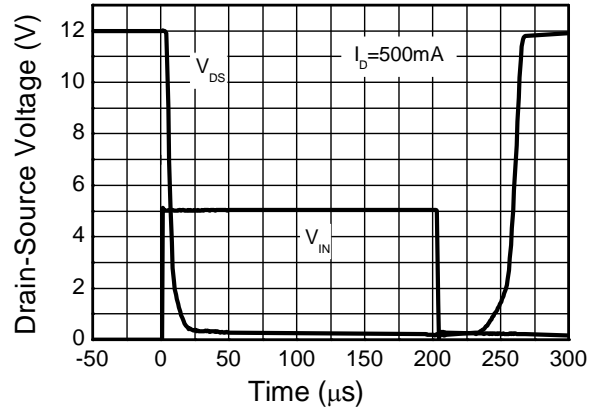

Switching Speed

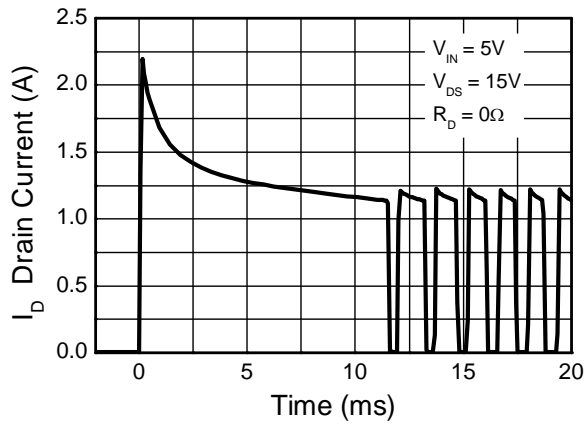

Typical Short Circuit Protection

Package Outline Dimensions

Please see AP02001 at http://www.diodes.com/_files/datasheets/ap02001.pdf for the latest version.

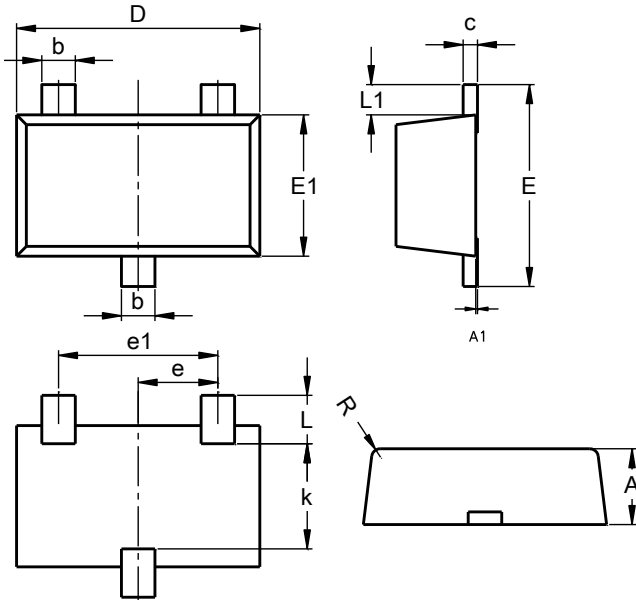

| SOT23F | | | |
|----------------------|-----------|------|------|
| Dim | Min | Max | Typ |
| A | 0.80 | 1.00 | 0.90 |
| b | 0.35 | 0.50 | 0.44 |
| c | 0.10 | 0.20 | 0.16 |
| D | 2.80 | 3.00 | 2.90 |
| e | 0.95 REF | | |
| e1 | 0.190 REF | | |
| E | 2.30 | 2.50 | 2.40 |
| E1 | 1.50 | 1.70 | 1.65 |
| k | 1.20 | - | - |
| L | 0.30 | 0.65 | 0.50 |
| L1 | 0.30 | 0.50 | 0.40 |
| R | 0.05 | 0.15 | - |
| All Dimensions in mm | | | |

Suggested Pad Layout

Please see AP02001 at http://www.diodes.com/_files/datasheets/ap02001.pdf for the latest version.

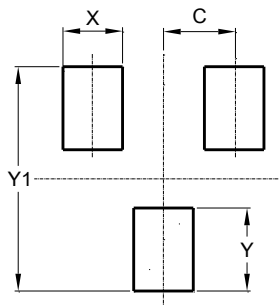

| Dimensions | Value (in mm) |
|------------|---------------|
| C | 0.95 |
| X | 0.80 |
| Y | 1.110 |
| Y1 | 3.000 |

IMPORTANT NOTICE

DIODES INCORPORATED MAKES NO WARRANTY OF ANY KIND, EXPRESS OR IMPLIED, WITH REGARDS TO THIS DOCUMENT, INCLUDING, BUT NOT LIMITED TO, THE IMPLIED WARRANTIES OF MERCHANTABILITY AND FITNESS FOR A PARTICULAR PURPOSE (AND THEIR EQUIVALENTS UNDER THE LAWS OF ANY JURISDICTION).

Diodes Incorporated and its subsidiaries reserve the right to make modifications, enhancements, improvements, corrections or other changes without further notice to this document and any product described herein. Diodes Incorporated does not assume any liability arising out of the application or use of this document or any product described herein; neither does Diodes Incorporated convey any license under its patent or trademark rights, nor the rights of others. Any Customer or user of this document or products described herein in such applications shall assume all risks of such use and will agree to hold Diodes Incorporated and all the companies whose products are represented on Diodes Incorporated website, harmless against all damages.

Diodes Incorporated does not warrant or accept any liability whatsoever in respect of any products purchased through unauthorized sales channel. Should Customers purchase or use Diodes Incorporated products for any unintended or unauthorized application, Customers shall indemnify and hold Diodes Incorporated and its representatives harmless against all claims, damages, expenses, and attorney fees arising out of, directly or indirectly, any claim of personal injury or death associated with such unintended or unauthorized application.

Products described herein may be covered by one or more United States, international or foreign patents pending. Product names and markings noted herein may also be covered by one or more United States, international or foreign trademarks.

This document is written in English but may be translated into multiple languages for reference. Only the English version of this document is the final and determinative format released by Diodes Incorporated.

LIFE SUPPORT

Diodes Incorporated products are specifically not authorized for use as critical components in life support devices or systems without the express written approval of the Chief Executive Officer of Diodes Incorporated. As used herein:

A. Life support devices or systems are devices or systems which:

1. are intended to implant into the body, or
2. support or sustain life and whose failure to perform when properly used in accordance with instructions for use provided in the labeling can be reasonably expected to result in significant injury to the user.

B. A critical component is any component in a life support device or system whose failure to perform can be reasonably expected to cause the failure of the life support device or to affect its safety or effectiveness.

Customers represent that they have all necessary expertise in the safety and regulatory ramifications of their life support devices or systems, and acknowledge and agree that they are solely responsible for all legal, regulatory and safety-related requirements concerning their products and any use of Diodes Incorporated products in such safety-critical, life support devices or systems, notwithstanding any devices- or systems-related information or support that may be provided by Diodes Incorporated. Further, Customers must fully indemnify Diodes Incorporated and its representatives against any damages arising out of the use of Diodes Incorporated products in such safety-critical, life support devices or systems.

Copyright © 2016, Diodes Incorporated

www.diodes.com

Компания «Океан Электроники» предлагает заключение долгосрочных отношений при поставках импортных электронных компонентов на взаимовыгодных условиях!

Наши преимущества:

- Поставка оригинальных импортных электронных компонентов напрямую с производств Америки, Европы и Азии, а так же с крупнейших складов мира;
- Широкая линейка поставок активных и пассивных импортных электронных компонентов (более 30 млн. наименований);
- Поставка сложных, дефицитных, либо снятых с производства позиций;
- Оперативные сроки поставки под заказ (от 5 рабочих дней);
- Экспресс доставка в любую точку России;
- Помощь Конструкторского Отдела и консультации квалифицированных инженеров;
- Техническая поддержка проекта, помощь в подборе аналогов, поставка прототипов;
- Поставка электронных компонентов под контролем ВП;
- Система менеджмента качества сертифицирована по Международному стандарту ISO 9001;
- При необходимости вся продукция военного и аэрокосмического назначения проходит испытания и сертификацию в лаборатории (по согласованию с заказчиком);
- Поставка специализированных компонентов военного и аэрокосмического уровня качества (Xilinx, Altera, Analog Devices, Intersil, Interpoint, Microsemi, Actel, Aeroflex, Peregrine, VPT, Syfer, Eurofarad, Texas Instruments, MS Kennedy, Miteq, Cobham, E2V, MA-COM, Hittite, Mini-Circuits, General Dynamics и др.);

Компания «Океан Электроники» является официальным дистрибьютором и эксклюзивным представителем в России одного из крупнейших производителей разъемов военного и аэрокосмического назначения «JONHON», а так же официальным дистрибьютором и эксклюзивным представителем в России производителя высокотехнологичных и надежных решений для передачи СВЧ сигналов «FORSTAR».



JONHON

«JONHON» (основан в 1970 г.)

Разъемы специального, военного и аэрокосмического назначения:

(Применяются в военной, авиационной, аэрокосмической, морской, железнодорожной, горно- и нефтедобывающей отраслях промышленности)

«FORSTAR» (основан в 1998 г.)

ВЧ соединители, коаксиальные кабели, кабельные сборки и микроволновые компоненты:

(Применяются в телекоммуникациях гражданского и специального назначения, в средствах связи, РЛС, а так же военной, авиационной и аэрокосмической отраслях промышленности).



Телефон: 8 (812) 309-75-97 (многоканальный)

Факс: 8 (812) 320-03-32

Электронная почта: ocean@oceanchips.ru

Web: <http://oceanchips.ru/>

Адрес: 198099, г. Санкт-Петербург, ул. Калинина, д. 2, корп. 4, лит. А