

FDD15 SERIES

DC - DC CONVERTER
10 ~ 15W SINGLE & DUAL OUTPUT



FEATURES

- LOW COST
- 2:1 WIDE INPUT RANGE
- I/O ISOLATION
- LC INPUT FILTER
- SHORT CIRCUIT PROTECTION
- HIGH PERFORMANCE
- 2 YEARS WARRANTY

MODEL LIST

| MODEL NO. | INPUT VOLTAGE | INPUT CURRENT (typ.) | OUTPUT WATTAGE | OUTPUT VOLTAGE | OUTPUT CURRENT | EFF. (min.) | EFF. (typ.) | CAPACITOR LOAD (max.) |
|-----------|---------------|----------------------|----------------|----------------|----------------|-------------|-------------|-----------------------|
|-----------|---------------|----------------------|----------------|----------------|----------------|-------------|-------------|-----------------------|

Single Output Models

| | | | | | | | | |
|--------------|-----------|--------|----------|-----------|---------|-----|-----|--------------|
| FDD15 - 03S1 | 9~18 VDC | 1.1 A | 10 WATTS | + 3.3 VDC | 3000 mA | 75% | 77% | 4700 μ F |
| FDD15 - 05S1 | 9~18 VDC | 1.08 A | 10 WATTS | + 5 VDC | 2000 mA | 75% | 77% | 4700 μ F |
| FDD15 - 12S1 | 9~18 VDC | 1.07 A | 10 WATTS | + 12 VDC | 834 mA | 75% | 77% | 3500 μ F |
| FDD15 - 15S1 | 9~18 VDC | 1.07 A | 10 WATTS | + 15 VDC | 667 mA | 76% | 78% | 3500 μ F |
| FDD15 - 03S2 | 18~36 VDC | 0.54 A | 10 WATTS | + 3.3 VDC | 3000 mA | 75% | 77% | 4700 μ F |
| FDD15 - 05S2 | 18~36 VDC | 0.79 A | 15 WATTS | + 5 VDC | 3000 mA | 78% | 80% | 4700 μ F |
| FDD15 - 12S2 | 18~36 VDC | 0.78 A | 15 WATTS | + 12 VDC | 1250 mA | 79% | 81% | 3500 μ F |
| FDD15 - 15S2 | 18~36 VDC | 0.77 A | 15 WATTS | + 15 VDC | 1000 mA | 80% | 82% | 3500 μ F |
| FDD15 - 03S3 | 36~72 VDC | 0.27 A | 10 WATTS | + 3.3 VDC | 3000 mA | 74% | 76% | 4700 μ F |
| FDD15 - 05S3 | 36~72 VDC | 0.39 A | 15 WATTS | + 5 VDC | 3000 mA | 78% | 80% | 4700 μ F |
| FDD15 - 12S3 | 36~72 VDC | 0.39 A | 15 WATTS | + 12 VDC | 1250 mA | 79% | 81% | 3500 μ F |
| FDD15 - 15S3 | 36~72 VDC | 0.39 A | 15 WATTS | + 15 VDC | 1000 mA | 79% | 81% | 3500 μ F |

Dual Output Models

| | | | | | | | | |
|--------------|-----------|--------|----------|--------------|--------------|-----|-----|--------------------|
| FDD15 - 12D1 | 9~18 VDC | 1.12 A | 10 WATTS | \pm 12 VDC | \pm 417 mA | 73% | 76% | \pm 1000 μ F |
| FDD15 - 15D1 | 9~18 VDC | 1.09 A | 10 WATTS | \pm 15 VDC | \pm 334 mA | 75% | 78% | \pm 1000 μ F |
| FDD15 - 12D2 | 18~36 VDC | 0.77 A | 15 WATTS | \pm 12 VDC | \pm 625 mA | 80% | 83% | \pm 1000 μ F |
| FDD15 - 15D2 | 18~36 VDC | 0.77 A | 15 WATTS | \pm 15 VDC | \pm 500 mA | 80% | 83% | \pm 1000 μ F |
| FDD15 - 12D3 | 36~72 VDC | 0.38 A | 15 WATTS | \pm 12 VDC | \pm 625 mA | 80% | 83% | \pm 1000 μ F |
| FDD15 - 15D3 | 36~72 VDC | 0.38 A | 15 WATTS | \pm 15 VDC | \pm 500 mA | 80% | 83% | \pm 1000 μ F |

SPECIFICATION

All Specifications Typical At Nominal Line, Full Load, 25°C Unless Otherwise Noticed

GENERAL

| Characteristics | Conditions | min. | typ. | max. | unit |
|-------------------------|-----------------------------|-----------------------|--------|--------|--------|
| Switching frequency | Vi nom, Io nom | | 200 | | KHz |
| Isolation voltage | Input - Output | 1500 | | | VDC |
| Isolation resistance | Input - Output, @ 500VDC | 100 | | | MΩ |
| Isolation capacitance | 100KHz / 1V | | | 1000 | PF |
| Ambient temperature | Operating at Vi nom, Io nom | -10 | | + 51 | °C |
| Case temperature | Operating at Vi nom, Io nom | | | + 85 | °C |
| Derating | Vi nom | See derating curve | | | |
| Storage temperature | Non operational | -25 | | + 100 | °C |
| Relative humidity | Vi nom, Io nom | 20 | | 95 | % RH |
| Temperature coefficient | Vi nom, Io min | | | ± 0.02 | % / °C |
| Dimension | | L50.8 x W50.8 x H12.0 | | | mm |
| MTBF | Bellcore issue 6@40°C, GB | | 889000 | | Hours |
| Cooling | Free air convection | | | | |

INPUT SPECIFICATIONS

| Characteristics | Conditions | min. | typ. | max. | unit |
|--------------------------|------------------------------|------------|------|------|------|
| Input voltage range | Ta min ... Ta max, Io nom | 9 | 12 | 18 | VDC |
| | | 18 | 24 | 36 | VDC |
| | | 36 | 48 | 72 | VDC |
| No load input current | Vi nom, Io = 0 | 12V models | | 30 | mA |
| | | 24V models | | 25 | mA |
| | | 48V models | | 15 | mA |
| Input voltage w/o damage | Io nom | 12V models | | 20 | VDC |
| | | 24V models | | 40 | VDC |
| | | 48V models | | 75 | VDC |
| Startup voltage | Io nom | 12V models | 8.5 | | VDC |
| | | 24V models | 15 | | VDC |
| | | 48V models | 35 | | VDC |
| Input filter | Pi type | | | | |

OUTPUT SPECIFICATIONS

| Characteristics | Conditions | min. | typ. | max. | unit |
|-------------------------------|---|--|------|-------------|------|
| Output voltage accuracy | Vi nom, Io nom | | | ± 2 | % |
| Minimum load | Vi nom single output models | 0 | | | % |
| | Vi nom dual output models (each output) | 20 | | | % |
| Line regulation | Io nom, Vi min ... Vi max | | | ± 1 | % |
| Load regulation | Vi nom, Io 0 ... Io nom, single output models | | | ± 2 | % |
| | Vi nom, Io min ... Io nom, dual output models | | | ± 5 | % |
| Cross regulation (Dual model) | Aymmetrical load 20% - 100% FL | | | ± 5 | % |
| Startup time | Vi nom, Io nom | | | 1000 | ms |
| Transient recovery time | Vi nom, I ~ 0.5 Io nom | | | 500 | μs |
| Ripple & noise | Vi nom, Io nom, 3.3V model | | | 100 | mV |
| | Vi nom, Io nom, BW = 20MHz 5V, 12V, 15V & dual | | | Vout x ± 1% | mV |
| Efficiency | Vi nom, Io nom, Po / Pi | Up to 83%, See model list and efficiency curve | | | |

CONTROL AND PROTECTION

| | |
|----------------------------|--|
| Input reversed | Shunt diode built in, external fuse recommended (12Vin : 1.5A, 24Vin : 1 A, 48Vin : 0.5 A) |
| Output short circuit | Current limited (Auto-recovery) |
| Rated over load protection | 110%min....140%max |

PHYSICAL CHARACTERISTICS

| | |
|------------------|---|
| Case size | 50.8 x 50.8 x 12.0 mm (2 x 2 x 0.47 inches) |
| Case material | Plastic base / Metal case |
| Weight | 70 g |
| Patting material | Epoxy |

MECHANISM & PIN CONFIGURATION

mm [inch]

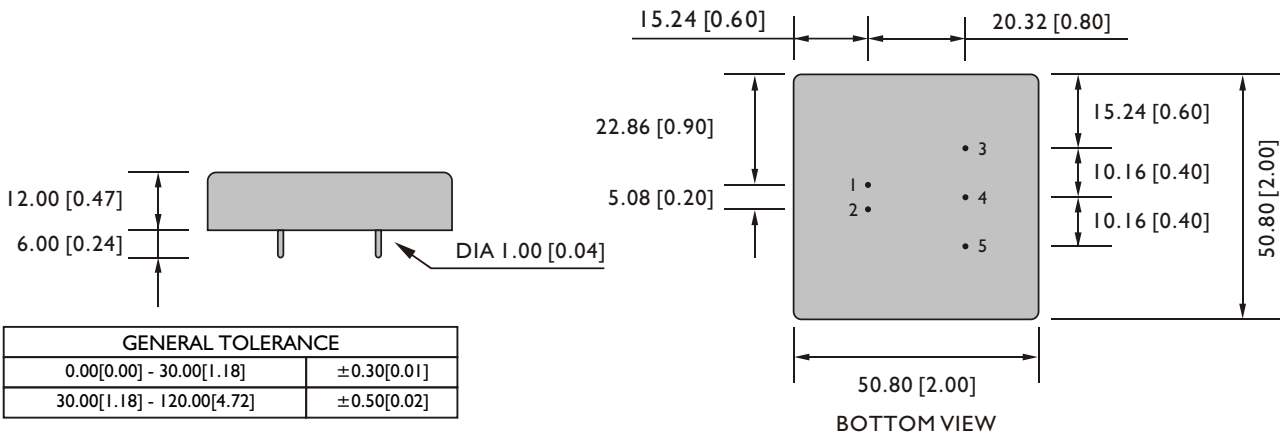

PIN ASSIGNMENT

GENERAL

| PIN NO. | 1 | 2 | 3 | 4 | 5 |
|---------|-----|-----|-----|--------|-----|
| SINGLE | Vi+ | Vi- | Vo+ | NO PIN | Vo- |
| DUAL | Vi+ | Vi- | Vo+ | com | Vo- |

CIRCUIT SCHEMATIC

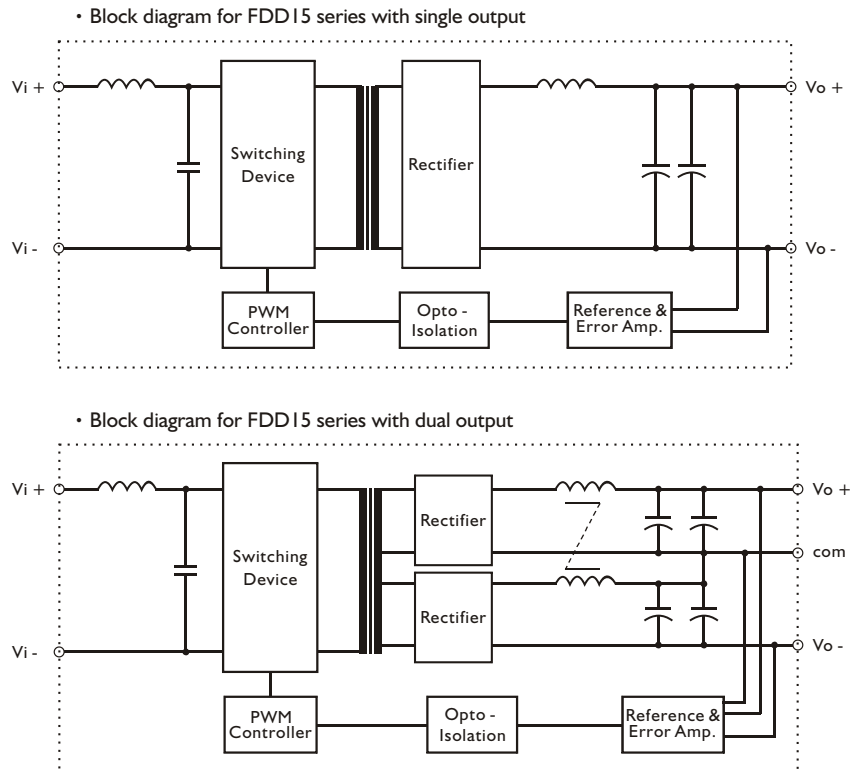

RECOMMENDED CIRCUIT

- Recommended filter for EN55022 Class B compliance

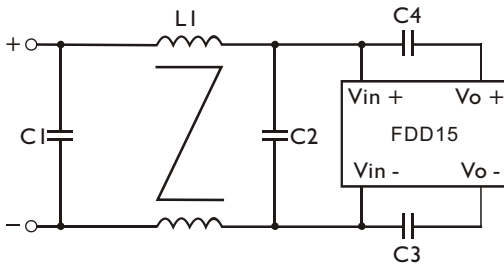

- The components used in the above figure, together with the manufacturer part numbers for these components, are as follows.

| | C1 | C2 | C3 | C4 | L1 |
|------------|-------------------------|-------------------------|----------------|----------------|--------------------|
| FDD15-XXX1 | 6.8 μ F / 50V MLCC | 4.7 μ F / 50V MLCC | 1nF / 2KV MLCC | 1nF / 2KV MLCC | 0.5mH Common Choke |
| FDD15-XXX2 | 4.7 μ F / 50V MLCC | 4.7 μ F / 50V MLCC | 1nF / 2KV MLCC | 1nF / 2KV MLCC | 0.5mH Common Choke |
| FDD15-XXX3 | 4.7 μ F / 100V MLCC | 4.7 μ F / 100V MLCC | 1nF / 2KV MLCC | 1nF / 2KV MLCC | 0.5mH Common Choke |

- Recommended EN 55022 Class B filter circuit layout.

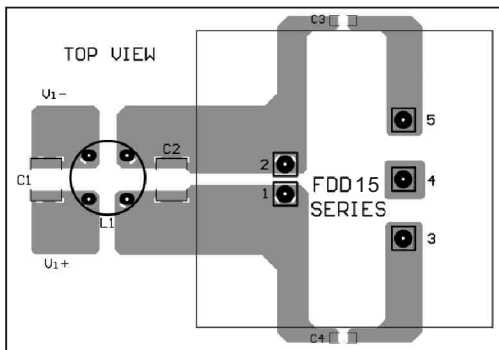

DERATING AND EFFICIENCY CURVE

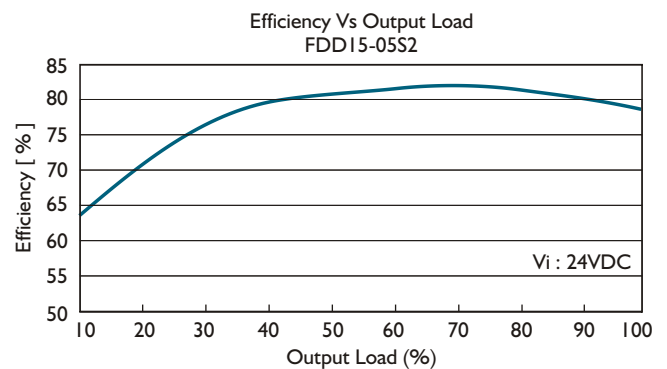
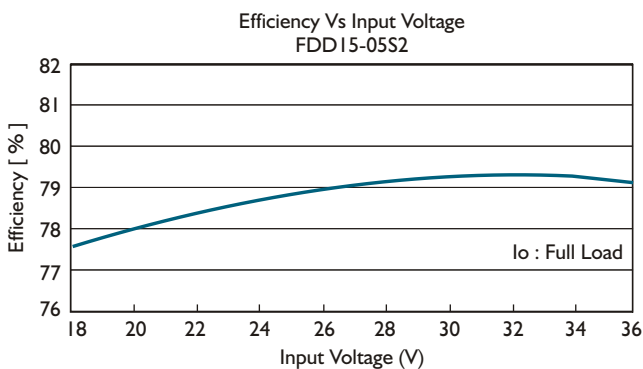
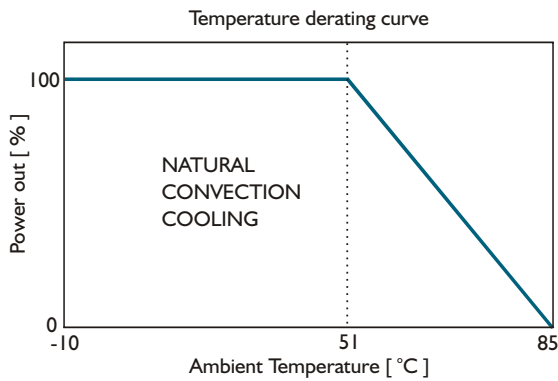

FDD15 SERIES

DC - DC CONVERTER
10 ~ 15W TRIPLE OUTPUT



FEATURES

- LOW COST
- 2:1 WIDE INPUT RANGE
- I/O ISOLATION
- LC INPUT FILTER
- SHORT CIRCUIT PROTECTION
- HIGH PERFORMANCE
- 2 YEARS WARRANTY

MODEL LIST

| MODEL NO. | INPUT VOLTAGE | INPUT CURRENT (typ.) | OUTPUT WATTAGE | OUTPUT VOLTAGE | OUTPUT CURRENT | EFF. (min.) | EFF. (typ.) | CAPACITOR LOAD (max.) |
|-----------------------------|---------------|----------------------|----------------|----------------|----------------|-------------|-------------|-----------------------|
| Triple Output Models | | | | | | | | |
| FDD15 - 0512T1 | 9~18 VDC | 1.07 A | 10 WATTS | +5 / ±12 VDC | 1.5A / ± 0.12A | 77% | 79% | 4700 μF / ±2200 μF |
| FDD15 - 0515T1 | 9~18 VDC | 1.07 A | 10 WATTS | +5 / ±15 VDC | 1.5A / ± 0.1 A | 77% | 79% | 4700 μF / ±2200 μF |
| FDD15 - 0512T2 | 18~36 VDC | 0.76 A | 15 WATTS | +5 / ±12 VDC | 2 A / ± 0.2 A | 80% | 82% | 4700 μF / ±2200 μF |
| FDD15 - 0515T2 | 18~36 VDC | 0.76 A | 15 WATTS | +5 / ±15 VDC | 2 A / ± 0.16A | 80% | 82% | 4700 μF / ±2200 μF |
| FDD15 - 0512T3 | 36~72 VDC | 0.38 A | 15 WATTS | +5 / ±12 VDC | 2 A / ± 0.2 A | 80% | 82% | 4700 μF / ±2200 μF |
| FDD15 - 0515T3 | 36~72 VDC | 0.38 A | 15 WATTS | +5 / ±15 VDC | 2 A / ± 0.16A | 80% | 82% | 4700 μF / ±2200 μF |

SPECIFICATION

All Specifications Typical At Nominal Line, Full Load, 25°C Unless Otherwise Noticed

GENERAL

| Characteristics | Conditions | min. | typ. | max. | unit |
|-------------------------|-----------------------------|-----------------------|--------|--------|--------|
| Switching frequency | Vi nom, Io nom | | 180 | | KHz |
| Isolation voltage | Input - Output | 1500 | | | VDC |
| Isolation resistance | Input - Output, @ 500VDC | 100 | | | MΩ |
| Isolation capacitance | 100KHz / 1V | | | 1000 | PF |
| Ambient temperature | Operating at Vi nom, Io nom | -10 | | + 51 | °C |
| Case temperature | Operating at Vi nom, Io nom | | | +100 | °C |
| Derating | Vi nom | See derating curve | | | |
| Storage temperature | Non operational | -40 | | +100 | °C |
| Relative humidity | Vi nom, Io nom | 20 | | 95 | % RH |
| Temperature coefficient | Vi nom, Io min | | | ± 0.02 | % / °C |
| Dimension | | L50.8 x W50.8 x H12.0 | | | mm |
| MTBF | Belcore issue 6@40°C, GB | | 720000 | | Hours |
| Cooling | Free air convection | | | | |

INPUT SPECIFICATIONS

| Characteristics | Conditions | min. | typ. | max. | unit |
|--------------------------|---------------------------|------------|------|------|------|
| Input voltage range | Ta min ... Ta max, Io nom | 9 | 12 | 18 | VDC |
| | | 18 | 24 | 36 | VDC |
| | | 36 | 48 | 72 | VDC |
| No load input current | Vi nom, Io = 0 | 12V models | | 30 | mA |
| | | 24V models | | 25 | mA |
| | | 48V models | | 15 | mA |
| Input voltage w/o damage | Io nom | 12V models | | 20 | VDC |
| | | 24V models | | 40 | VDC |
| | | 48V models | | 75 | VDC |
| Startup voltage | Io nom | 12V models | 8.5 | | VDC |
| | | 24V models | 13.6 | | VDC |
| | | 48V models | 24 | | VDC |
| Input filter | Pi type | | | | |

OUTPUT SPECIFICATIONS

| Characteristics | Conditions | min. | typ. | max. | unit |
|-------------------------|--------------------------------|--|------|-------------|------|
| Output voltage accuracy | Vi nom, Io nom | + 5V | | ± 2 | % |
| | | ±12V or ±15V | | ± 6 | % |
| Minimum load | Vi nom | + 5V | 10 | | % |
| | | ±12V or ±15V | 20 | | % |
| Line regulation | Vi min ...Vi max, Io nom | + 5V | | ± 2 | % |
| | | ±12V or ±15V | | ± 6 | % |
| Load regulation | Vi nom, Io min ...Io nom | + 5V | | ± 2 | % |
| | | ±12V or ±15V | | ± 6 | % |
| Cross regulation | Aymmetrical load 20% - 100% FL | | | ± 6 | % |
| Startup time | Vi nom, Io nom | | | 30 | ms |
| Transient recovery time | Vi nom, I ~ 0.5 Io nom | | | 500 | μs |
| Ripple & noise | Vi nom, Io nom, BW = 20MHz | | | Vout x ± 1% | mV |
| Efficiency | Vi nom, Io nom, Po / Pi | Up to 82%, See model list and efficiency curve | | | |

CONTROL AND PROTECTION

| | |
|----------------------------|---|
| Remote ON / OFF | ON : opened or 8 ~ 10VDC applied, reference to input GND OFF : -0.3 ~ 2VDC applied, reference to input GND |
| Input reversed | Shunt diode built in, external fuse recommended (12Vin : 1.5A, 24Vin : 1A, 48Vin : 0.5A) |
| Output short circuit | Current limited (Auto-recovery) |
| Rated over load protection | I 10%min.... 140%max |

PHYSICAL CHARACTERISTICS

| | |
|------------------|---|
| Case size | 50.8 x 50.8 x 12.0 mm (2 x 2 x 0.47 inches) |
| Case material | Plastic base / Metal case |
| Weight | 70 g |
| Patting material | Epoxy |

MECHANISM & PIN CONFIGURATION

mm [inch]

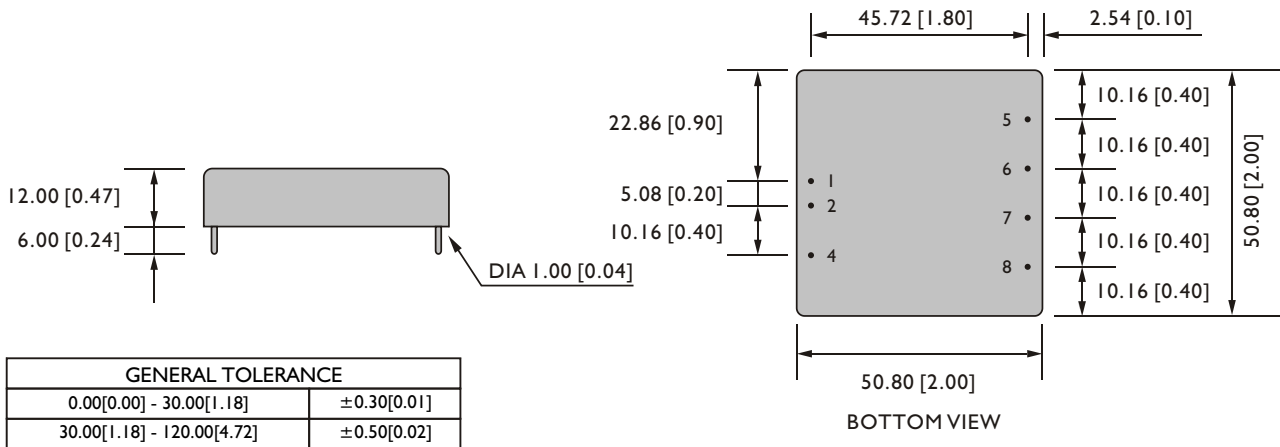

PIN ASSIGNMENT

GENERAL

| PIN NO. | 1 | 2 | 4 | 5 | 6 | 7 | 8 |
|---------|-----|-----|----------|----------------|---------------|-----|----------------|
| TRIPLE | Vi+ | Vi- | ON / OFF | Vo2 (+ OUT) | Vo1 (+ 5V) | com | Vo3 (- OUT) |

CIRCUIT SCHEMATIC

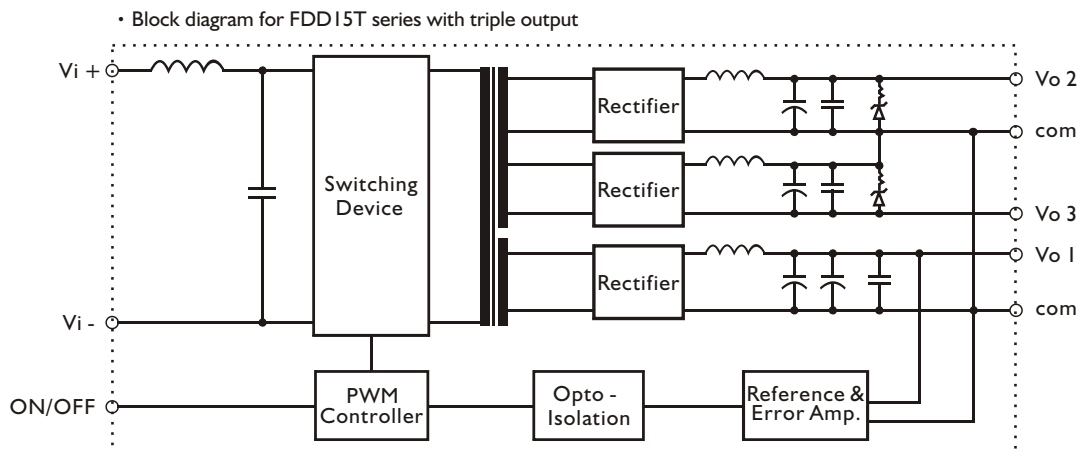

RECOMMENDED CIRCUIT

- Recommended filter for EN55022 Class B compliance

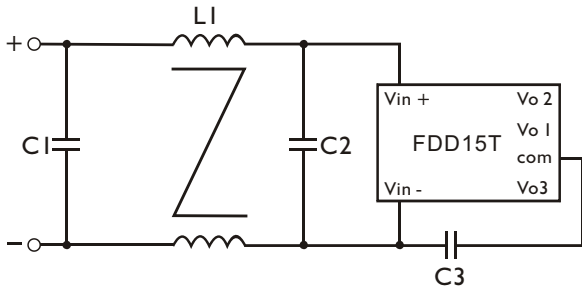

- The components used in the above figure, together with the manufacturer part numbers for these components, are as follows.

| | C1 | C2 | C3 | L1 |
|--------------|-------------------------|-------------------------|----------------|--------------------|
| FDD15-XXXXT1 | 3.3 μ F / 50V MLCC | 3.3 μ F / 50V MLCC | InF / 2KV MLCC | 0.5mH Common Choke |
| FDD15-XXXXT2 | 3.3 μ F / 50V MLCC | 3.3 μ F / 50V MLCC | InF / 2KV MLCC | 0.5mH Common Choke |
| FDD15-XXXXT3 | 2.2 μ F / 100V MLCC | 2.2 μ F / 100V MLCC | InF / 2KV MLCC | 0.5mH Common Choke |

- Recommended EN 55022 Class B filter circuit layout.

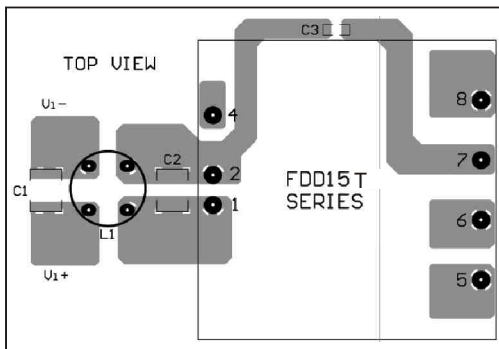

DERATING AND EFFICIENCY CURVE

Temperature derating curve

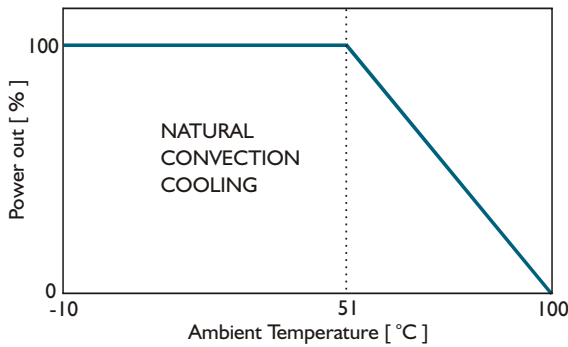

Efficiency Vs Input Voltage
FDD15-0515T2

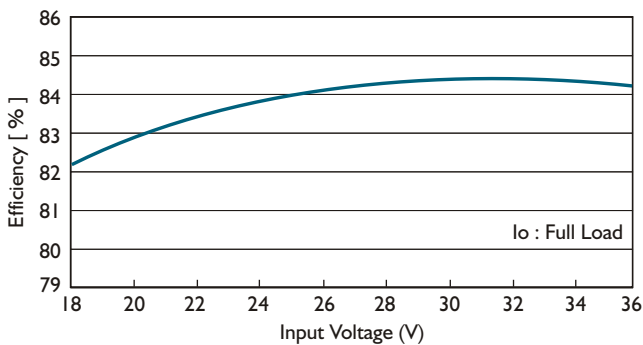

Efficiency Vs Output Load
FDD15-0515T2

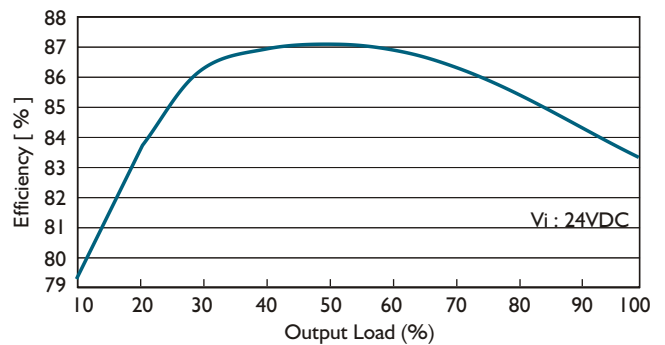

Компания «Океан Электроники» предлагает заключение долгосрочных отношений при поставках импортных электронных компонентов на взаимовыгодных условиях!

Наши преимущества:

- Поставка оригинальных импортных электронных компонентов напрямую с производств Америки, Европы и Азии, а так же с крупнейших складов мира;
- Широкая линейка поставок активных и пассивных импортных электронных компонентов (более 30 млн. наименований);
- Поставка сложных, дефицитных, либо снятых с производства позиций;
- Оперативные сроки поставки под заказ (от 5 рабочих дней);
- Экспресс доставка в любую точку России;
- Помощь Конструкторского Отдела и консультации квалифицированных инженеров;
- Техническая поддержка проекта, помощь в подборе аналогов, поставка прототипов;
- Поставка электронных компонентов под контролем ВП;
- Система менеджмента качества сертифицирована по Международному стандарту ISO 9001;
- При необходимости вся продукция военного и аэрокосмического назначения проходит испытания и сертификацию в лаборатории (по согласованию с заказчиком);
- Поставка специализированных компонентов военного и аэрокосмического уровня качества (Xilinx, Altera, Analog Devices, Intersil, Interpoint, Microsemi, Actel, Aeroflex, Peregrine, VPT, Syfer, Eurofarad, Texas Instruments, MS Kennedy, Miteq, Cobham, E2V, MA-COM, Hittite, Mini-Circuits, General Dynamics и др.);

Компания «Океан Электроники» является официальным дистрибьютором и эксклюзивным представителем в России одного из крупнейших производителей разъемов военного и аэрокосмического назначения «JONHON», а так же официальным дистрибьютором и эксклюзивным представителем в России производителя высокотехнологичных и надежных решений для передачи СВЧ сигналов «FORSTAR».



JONHON

«JONHON» (основан в 1970 г.)

Разъемы специального, военного и аэрокосмического назначения:

(Применяются в военной, авиационной, аэрокосмической, морской, железнодорожной, горно- и нефтедобывающей отраслях промышленности)

«FORSTAR» (основан в 1998 г.)

ВЧ соединители, коаксиальные кабели, кабельные сборки и микроволновые компоненты:

(Применяются в телекоммуникациях гражданского и специального назначения, в средствах связи, РЛС, а так же военной, авиационной и аэрокосмической отраслях промышленности).



Телефон: 8 (812) 309-75-97 (многоканальный)

Факс: 8 (812) 320-03-32

Электронная почта: ocean@oceanchips.ru

Web: <http://oceanchips.ru/>

Адрес: 198099, г. Санкт-Петербург, ул. Калинина, д. 2, корп. 4, лит. А