

Push-Pull connectors



Introduction

This catalog presents the push-pull connectors ranges for industrial applications.

These products are particularly suitable for high reliability and high quality applications where a simple yet fast method to connect/disconnect is required. Also suitable for high endurance and ease of operation in very limited spaces. The aesthetics of the product allows for perfect integration on front panel equipments.

SOURIAU offers 3 main series of metallic circular connectors :

- **JBX series** : basic push-pull series for signal transmission
- **JKX series** : environmental version of the JBX series sealed to IP68
- **JAX series** : complementary range including coaxial contact layouts.

Contents

| | |
|--|-------|
| Where and why push-pull | 3 |
| Selection guide | 4 |
| JBX series | |
| • <i>Main features - Part number system</i> | 5 |
| • <i>Shell types and dimensions</i> | 6-8 |
| • <i>Keying</i> | 9 |
| • <i>Contact layouts</i> | 10-12 |
| • <i>Options</i> | 13 |
| • <i>Technical characteristics</i> | 14 |
| • <i>Wiring and assembly instructions</i> | 15-19 |
| JAX series | |
| • <i>Main features - Part number system</i> | 20 |
| • <i>Shell types and dimensions</i> | 21 |
| • <i>Contact layouts</i> | 22 |
| • <i>Suffix for cable outside diameter - Options</i> | 23 |
| • <i>Technical characteristics</i> | 24 |
| • <i>JAX camac series</i> | 25-26 |
| • <i>Wiring and assembly instructions</i> | 27-30 |
| JKX series | |
| • <i>Main features - Part number system</i> | 31 |
| • <i>Shell types and dimensions</i> | 32 |
| • <i>Keying - contact layouts</i> | 33 |
| • <i>Options</i> | 34 |
| • <i>Technical characteristics</i> | 35 |
| • <i>Wiring and assembly instructions</i> | 36-39 |
| JBX series-sealed version size 2 | |
| • <i>Main features - Part number system</i> | 40 |
| • <i>Shell types and dimensions</i> | 41 |
| • <i>Keying - contact layouts</i> | 42 |
| • <i>Technical informations</i> | 43 |
| Accessories - Piece parts | 44-46 |
| Toolings | 47-48 |
| More about our know-how | 49 |
| Requirement form | 50 |
| Conversion table | 51 |

All dimensions are in mm



Where and Why **push-pull ?**

Medical



- Extremely fast and easy to use
- A thousand matings/unmatings.
- Quality aesthetics for more value added on the equipment
- Space saving

Professional audio-video



GPS



Instrumentation



Telecommunications



Selection Guide



| | | | | |
|---------------------------|---|---|---|---|
| Shell material | Brass | Brass | Brass | Brass |
| Insulator material | Tefzel for coaxial contact Nylatron for multipin layout | Fortron Peek for layout with contacts of 0.5 mm of Ø | Fortron Peek for layout with contacts of 0.5 mm of Ø | Fortron Peek for layout with contacts of 0.5 mm of Ø |
| Shielding | Shielded (65 dB up to 100 MHz) | Shielded (55 dB up to 100 MHz) | Shielded (55 dB up to 100 MHz) | Shielded (55 dB up to 100 MHz) |
| Endurance | > 1000 cycles | > 1000 cycles | > 1000 cycles | > 1000 cycles |
| Current rating | up to 30 A | up to 30 A | up to 15 A | up to 30 A |
| Temperature range | - 40°C ; + 125°C (- 40°F ; + 257°F) | - 50°C ; + 125°C (- 58°F ; + 257°F) | - 50°C ; + 125°C (- 58°F ; + 257°F) | - 40°C ; + 80°C (- 40°F ; + 176°F) |
| Protection index | IP 40 | IP 40 | IP 68 when mated | IP 67 |
| Specific version | JAX Camac connectors (coaxial, size 00) (optional sealed version : consult us) | | | |

Push-pull locking system

The locking of the plug into the receptacle is achieved by a simple axial push on the outer shell.



Connection cannot be broken by pulling the cable or any other parts of the plug than the outer shell.



To unmate the plug from the receptacle, just pull axially the outer shell.

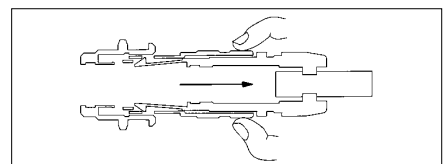

JBX Series



Key features

- Mechanically keyed : ensures correct polarisation and alignment.
- Contact layouts from 2 to 30 contacts.
- Wire gauges range from 30 AWG to 12 AWG.
- High contact density in a small space.
- Contact termination in either crimp, solder or PCB contacts.



User advantages

Blister packaging



6-collet cluster

Allows a wide range of cable diameter applications for a single connector.
Reduces inventory variations



Removable contacts

Available crimp versions allow easier wiring and maintenance.



Part number system

| | |
|----------------------------|---|
| Basic series | JBX FD 1 G 05 M C S D S M |
| Shell type | FD-FC-ER-EA-SR-PC-ED-EP-EZ |
| Shell size | 00 - 0 - 1 - 2 - 3 |
| Keying | G - J - A - B & customs are available |
| Contact layout | 02 ----- 30 |
| Contact type | M : pin F : socket |
| Contact termination | C : crimp ; S : solder ; P* : straight PCB tails ; Q* : 90° PCB tails ; W : 0.7 mm clipped solder |
| Material & surface plating | S : Outer shell in brass alloy with chrome over nickel N : Outer shell in brass alloy with black plating D : Obligatory suffix S : Insulator in PPS P : insulator in PEEK |
| Options | M : Connector with backnut for protective boot - Protective boot to order separately page 13 R : Red dot (possible for FD, FC, PC, SR, ER, ED, EZ only) |

* For receptacles with female contacts only

JBX Series



Shell types

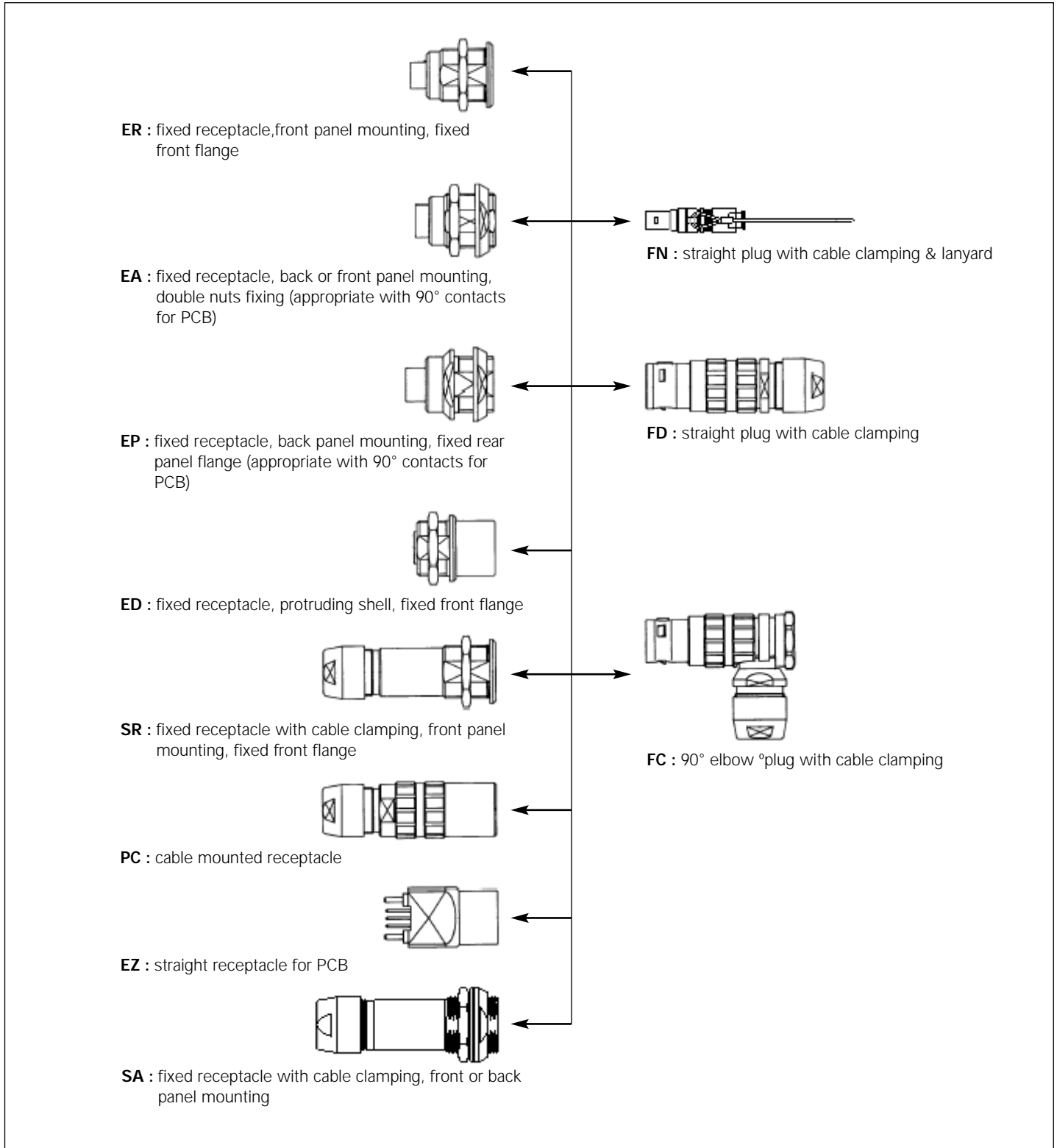

JBX Series



Dimensions*

ER : Fixed receptacle, front panel mounting*



| Size | 00 | 0 | 1 | 2 | 3* |
|------------|-----|-----|-----|-----|-----|
| A | 14 | 19 | 21 | 24 | 28 |
| B | 6 | 8 | 10 | 10 | 12 |
| C | 0.8 | 1.2 | 1.5 | 1.8 | 2.0 |
| Ø D | 8 | 10 | 14 | 18 | 22 |

*Lock washer not available

EA : Double nut receptacle*



| Size | 0 | 1 | 2 | 3* |
|------------|-----|-----|-----|-----|
| A | 19 | 21 | 24 | 28 |
| B | 6.7 | 8.3 | 8 | 9.5 |
| C | 2.5 | 3.2 | 3.8 | 4.5 |
| Ø D | 12 | 16 | 20 | 24 |

*Lock washer not available

EP : Fixed receptacle, back panel mounting

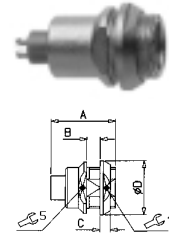

| Size | 0 | 1 | 2 |
|------------|-----|-----|-----|
| A | 19 | 21 | 24 |
| B | 4.5 | 6 | 6.5 |
| C | 2.5 | 3.2 | 3.8 |
| Ø D | 12 | 16 | 20 |

FD : Straight plug



| Size | 00 | 0 | 1 | 2 | 3 |
|------------|----|----|----|----|----|
| A | 31 | 39 | 45 | 52 | 62 |
| B | 23 | 29 | 34 | 40 | 47 |
| Ø C | 7 | 10 | 12 | 15 | 18 |

ED : Protruding receptacle



| Size | 0 | 1 | 2 |
|------------|-----|-----|-----|
| A | 19 | 21 | 24 |
| B | 3 | 4.5 | 6.3 |
| C | 1.2 | 1.5 | 1.8 |
| Ø D | 10 | 14 | 18 |

SR : Cable clamp receptacle*



| Size | 0 | 1 | 2 | 3 |
|------------|-----|-----|-----|----|
| A | 38 | 43 | 50 | 59 |
| B | 8 | 10 | 10 | 12 |
| C | 1.2 | 1.5 | 1.8 | 2 |
| Ø D | 10 | 14 | 18 | 22 |

*Lock washer not available

FC : 90° elbow plug



| Size | 0 | 1 | 2 | 3 |
|------------|------|------|------|------|
| A | 30.5 | 36.5 | 42.5 | 50.5 |
| B | 20.5 | 25.5 | 30.5 | 35.5 |
| C | 29.5 | 33.5 | 36.5 | 45 |
| Ø D | 10 | 12 | 15 | 18 |

PC : Cable mounted receptacle



| Size | 0 | 1 | 2 | 3 |
|------------|----|----|----|------|
| A | 38 | 43 | 50 | 59 |
| Ø B | 10 | 13 | 16 | 19.5 |

EZ : Receptacle for PCB

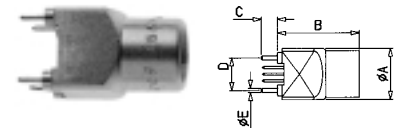

| Size | 0 | 1 |
|------------|----------|----------|
| Ø A | 10 | 12 |
| B | 19 | 21 |
| C | 4 | 4 |
| D | 7.62 sq. | 7.62 sq. |
| Ø E | 1.1 | 1.1 |

*All dimensions in mm.

JBX Series



Dimensions

• Special custom shells

FN : Straight plug,
shell 0 with a lanyard

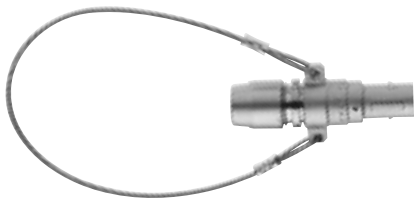

FM : 90° elbow plug,
shell 0 with a lanyard



FF : Straight plug,
with no latching, size 1



SA : fixed receptacle with cable clamping,
front or back panel mounting



JBX Series



Keying

• Keying angles

JBX Series are mechanically keyed to ensure correct alignment of the inserts before the contacts mate.

«G» : standard keying

«J» : standard reverse gender keying ; plugs with socket contacts, receptacles with pin contacts.

*G & J are standard keying, but all keying configurations can use standard or reverse gender.

| Key | G | J | | A | B |
|--------------|----|-------------|-------------|-----|-------------|
| | | sizes 0 - 1 | sizes 2 - 3 | | sizes 0 - 1 |
| Keying angle | 0° | 45° | 37.5° | 30° | 60° |
| Plug | | | | | |
| Receptacle | | | | | |

• Keyed shells availability

| Shell size | Key | ER | EA | ED | EP | EZ | SR | PC | FD | FC | FM | FN | SA |
|------------|------------------|------------------|--------|----|----|----|----|----|------------------|--------|----|----|----|
| 00 | G | ● | | | | | | | ● | | | | |
| 0 | G J A B | ● ● ● ● | ● ● | ● | ● | ● | ● | ● | ● ● ● ● | ● ● | ● | ● | ● |
| 1 | G J A | ● ● ● | ● ● | ● | ● | ● | ● | ● | ● ● ● | ● ● | | | |
| 2 | G J A | ● ● ● | ● ● | ● | ● | | ● | ● | ● ● ● | ● ● | | | ● |
| 3 | G | ● | ● | | | | ● | ● | ● | ● | | | |

● Available for JBX series, customs can be ordered contact Project Management.

JBX Series



Contact layouts

• Multi contact inserts

| Shell size | Male insulator viewed from wiring side | Contact layout | Contact types available | | | | Ø Contact | AWG | | Max. current rating (A)* | Testing voltage (Vrms)* | Working voltage (Vdc / Vrms)* |
|------------|--|----------------|-------------------------|---------|-----------------------|------------------|-----------|------------------|-----------------|--------------------------|-------------------------|-------------------------------|
| | | | S solder | C crimp | P* straight PCB tails | Q* 90° PCB tails | | Solder wire Max. | Crimp wire Max. | | | |
| 00 | | 04 | S | | | | 0.5 | 30 | - | 2 | 1000 | 500/350 |
| 0 | | 02 | S | C | P | Q | 0.9 | 24 | 20 | 10 | 1400 | 660/460 |
| | | 03 | S | C | P | Q | 0.9 | 24 | 20 | 8 | 1300 | 600/420 |
| | | 04 | S | C | P | Q | 0.7 | 26 | 22 | 7 | 1400 | 660/460 |
| | | 05 | S | C | P | Q | 0.7 | 26 | 22 | 6.5 | 800 | 400/260 |
| | | 06 | S | | P | | 0.5 | 28 | - | 2.5 | 680 | 320/220 |
| | | 07 | S | | P | | 0.5 | 28 | - | 2.5 | 680 | 320/220 |
| 1 | | 02 | S | C | P | | 1.3 | 20 | 18 | 15 | 1600 | 760/530 |
| | | 03 | S | C | P | Q | 1.3 | 20 | 18 | 12 | 1300 | 600/420 |
| | | 04 | S | C | P | Q | 0.9 | 24 | 20 | 10 | 1900 | 900/630 |
| | | 05 | S | C | P | Q | 0.9 | 24 | 20 | 9 | 1400 | 660/460 |
| | | 06 | S | C | P | Q | 0.7 | 26 | 22 | 7 | 1400 | 660/460 |
| | | 07 | S | C | P | Q | 0.7 | 26 | 22 | 7 | 1400 | 660/460 |
| | | 08 | S | C | P | Q | 0.7 | 26 | 22 | 5 | 1200 | 600/420 |
| | | 10 | S | | | | 0.5 | 28 | - | 2.5 | 600 | 300/200 |

Inserts with fixed contacts (non removable contacts).

* For receptacles with female contacts only.

JBX Series



Contact layouts

• Multi contact inserts

| Shell size | Male insulator viewed from wiring side | Contact layout | Contact types available | | | | Ø Contact | AWG | | Max. current rating (A)* | Testing voltage (Vrms)* | Working voltage (Vdc / Vrms)* |
|------------|--|----------------|-------------------------|---------|-----------------------|------------------|-----------|------------------|-----------------|--------------------------|-------------------------|-------------------------------|
| | | | S solder | C crimp | P* straight PCB tails | Q* 90° PCB tails | | Solder wire Max. | Crimp wire Max. | | | |
| 2 | | 02 | S | C | | | 2 | 16 | 12 | 30 | 2100 | 1000/700 |
| | | 03 | S | C | | | 1.6 | 18 | 14 | 17 | 1700 | 830/560 |
| | | 04 | S | C | P | Q | 1.3 | 20 | 18 | 15 | 2400 | 1000/800 |
| | | 05 | S | C | P | Q | 1.3 | 20 | 18 | 14 | 1900 | 900/630 |
| | | 06 | S | C | P | Q | 1.3 | 20 | 18 | 12 | 1900 | 900/630 |
| | | 07 | S | C | P | Q | 1.3 | 20 | 18 | 11 | 1500 | 730/500 |
| | | 08 | S | C | P | Q | 0.9 | 24 | 20 | 10 | 1700 | 830/560 |
| | | 10 | S | C | P | Q | 0.9 | 24 | 20 | 8 | 1700 | 830/560 |
| | | 12 | S | C | P | Q | 0.7 | 26 | 22 | 7 | 1700 | 830/560 |
| | | 16 | S | C | P | Q | 0.7 | 26 | 22 | 6 | 1500 | 730/500 |
| | | 18 | S | C | P | | 0.7 | 26 | 22 | 5.5 | 1400 | 660/460 |
| | 19 | S | C | P | | 0.7 | 26 | 22 | 5 | 1400 | 660/460 | |
| 3 | | 03 | S | C | | | 2 | 16 | 12 | 25 | 3600 | 1600/1200 |
| | | 04 | S | C | | | 2 | 16 | 12 | 25 | 2500 | 1100/830 |

Inserts with fixed contacts (non removable contacts).

* For receptacles with female contacts.

JBX Series



Contact layouts

• Multi contact inserts

| Shell size | Male insulator viewed from wiring side | Contact layout side | Contact types available | | | | Ø Contact | AWG | | Max. current rating (A)* | Testing voltage (Vrms)* | Working voltage (Vdc / Vrms)* |
|------------|--|---------------------|-------------------------|---------|-----------------------|------------------|-----------|------------------|-----------------|--------------------------|-------------------------|-------------------------------|
| | | | S solder | C crimp | P* straight PCB tails | Q* 90° PCB tails | | Solder wire Max. | Crimp wire Max. | | | |
| 3 | | 07 | S | C | | | 1.6 | 18 | 14 | 15 | 2200 | 1000/730 |
| | | 10 | S | C | | | 1.3 | 20 | 18 | 12 | 1400 | 660/460 |
| | | 14 | S | C | P | | 0.9 | 24 | 20 | 9 | 1700 | 830/560 |
| | | 18 | S | C | P | | 0.9 | 24 | 20 | 7 | 1400 | 660/460 |
| | | 22 | S | C | P | | 0.7 | 26 | 22 | 5.5 | 1200 | 560/400 |
| | | 30 | S | C | P | | 0.7 | 26 | 26 | 3.5 | 800 | 400/260 |

Inserts with fixed contacts (non removable contacts).

* For receptacles with female contacts.

Note : Contacts are numbered counter clock wise in the plug and clock wise in the receptacle.

• Voltage Test Procedure

- **The testing voltage** corresponds to the maximum voltage the connector is able to withstand in normal climatic conditions. The value is about 75% of the electrical breakdown voltage. The testing voltage level can be reached several times in connectors life, but never applied for a continuous duration.
- **The working voltage** corresponds to the maximum voltage the connector is able to withstand continuously during its life time, in real environmental conditions, even with high temperature. The value is around 1/3 of the testing voltage.

• Maximum current rating

- This indicated maximum current rating corresponds to the maximum current that can be continuously applied to the connector mated pair, in normal climatic conditions.

Remark : If the current is applied on only one contact of the layout, then an increased current value can be achieved over a long duration.

JBX Series



Options

• Protective boot



| Part number | Shell size | Dimensions | | | |
|-------------|------------|------------|----|---------|------|
| | | Ø A | L | Ø Cable | |
| | | | | min | Max. |
| JBX 00 MPN | 00 | 1.5 | 15 | 1 | 3.5 |
| JBX 0 MP* | 0 | 2.2 | 20 | 1.5 | 5.5 |
| JBX 1 MP* | 1 | 2.6 | 25 | 2 | 7.5 |
| JBX 2 MP* | 2 | 4 | 30 | 3.5 | 9.7 |
| JBX 3 MP* | 3 | 5 | 35 | 4.9 | 12 |

* Color code / In size 00, available only in black



| Color code | Colors |
|------------|--------|
| A | blue |
| B | white |
| G | grey |
| J | yellow |
| M | brown |
| N | black |
| R | red |
| V | green |
| O | orange |

Material :

ELASTOLLAN (PUR)

Working temperature :

- 40°C ; + 80°C
- 40°F ; + 176°F

Parts that require a protective boot need to be ordered with an M suffix, see page 5. Protective boots are ordered separately.

With each JBX connector, one protective boot can accept multiple cable diameters thus the end-user can use various cable diameters without the need of multiple part numbers.

• Receptacle caps : an effective protection against dust



| Part number | Ø |
|-------------|-------|
| JBX BR0 | 12 mm |
| JBX BR1 | 14 mm |
| JBX BR2 | 17 mm |
| JBX BR3 | 20 mm |

JBX Series



Technical characteristics

• Material and treatment

UL approved - homologation file E 169916 

| Component | Material | Standard | | Surface treatment (µm) | | |
|--------------------------------|------------------|-----------|--------------|------------------------|-------|-----|
| | | ISO | ASTM | Cr | Ni | Au |
| Outer shell and collet nut | Brass | CuZn40Pb3 | C38500/C3600 | 0.1 - 0.6 | 5 - 8 | - |
| Latching sleeve & metal collet | Brass | CuZn40Pb3 | C38500/C3600 | - | 5 - 8 | - |
| Shielding ring | Brass | CuZn40Pb3 | C38500/C3600 | - | 3 - 7 | - |
| Nut | Brass | CuZn40Pb3 | C38500/C3600 | - | 5 - 8 | - |
| Half bushes | Brass | CuZn40Pb3 | C38500/C3600 | - | 5 - 8 | - |
| Socket contact (1) | Copper Nickel- | CuNi1Pb1P | CDA C 19150 | - | 3 - 5 | 0.5 |
| Pin contact (1) | Brass | CuZn35Pb2 | C35300/C3600 | - | 3 - 5 | 0.5 |
| Clip | Beryllium copper | CuBe1,9 | C17200 | - | - | - |

(1) Gold thickness as per MIL-G-45204C type 1, class 00.

| Component | Material | Color | Working Temperature | |
|----------------|--------------------------------|----------------|----------------------------------|----------------------------------|
| Insert | PPS + 40%GF or PEEK + 15%GF | black brown | - 65°C + 200°C - 50°C + 250°C | - 85°F + 392°F - 58°F + 482°F |
| Plastic collet | PA 6/6 + MoS2 | black | - 55°C + 125°C | - 67°F + 257°F |

• Mechanical and climatics

| Characteristics | Values | Standard | Method |
|-----------------------|---|---------------|------------------|
| Endurance | > 1000 cycles (except for 0.7 mm crimp contacts for which endurance is limited to 500 cycles) | MIL-STD 1344A | 2016.1 |
| Shock | 50 g, duration 6 ms ; contact Ø 0.7 mm and 0.9 mm 100 g, duration 6 ms ; contact Ø 1.3 mm - 1.6 mm and 2 mm | MIL-STD 1344A | 2004.1 |
| Vibrations | 10 to 2000 Hz $\gamma = 15$ g, contact Ø 0.7 mm and 0.9 mm $\gamma = 20$ g, contact Ø 1.3 mm - 1.6 mm and 2 mm | MIL-STD 1344A | 2005.1 |
| Protection index | IP 40 | CEI 529 | |
| Operating temperature | with plastic collets } - 55°C + 125°C - 67°F + 257°F | - | - |
| | with optional metal collets } - 55°C + 200°C - 67°F + 392°F | - | - |
| Gas | H ₂ S : 100 ppb ± 20 ppb SO ₂ : 500 ppb ± 100 ppb | IEC 68-2-60 | test Ke method 1 |
| Radiation stability | 10 ⁸ Rad | - | - |

JBX Series



Wiring and assembly instructions

• Panel cutout



| Size | 00 | 0 | 1 | 2 | 3 |
|-----------------|-----|-----|------|------|------|
| $\varnothing A$ | 7.1 | 9.1 | 12.1 | 15.1 | 18.1 |
| B | 6.4 | 8.3 | 10.6 | 13.6 | 16.6 |

• Removable contacts

Crimp contacts



| Contact | | Usable cables | | | Max. current rating (A) | Contact resistance (m Ω) | Endurance (number of cycles) |
|-----------------|-----------------|---------------------------------|-------|----------|-------------------------|----------------------------------|------------------------------|
| $\varnothing C$ | $\varnothing F$ | Core section (mm ²) | | AWG | | | |
| | | min | Max. | | | | |
| 0.7 | 0.85 | 0.129 | 0.326 | 22-24-26 | 7 | 5 | 500 Max. |
| 0.9 | 1.1 | 0.205 | 0.518 | 20-22-24 | 10 | 3.5 | > 1000 |
| 1.3 | 1.4 | 0.326 | 0.823 | 18-20-22 | 15 | 3 | > 1000 |
| 1.6 | 1.9 | 0.823 | 2.081 | 14-16-18 | 17 | 2.5 | > 1000 |
| 2.0 | 2.4 | 1.309 | 3.309 | 12-14-16 | 30 | 2.5 | > 1000 |

Solder contacts



| Contact | | Usable cables | | | Max. current rating (A) | Contact resistance (m Ω) | Endurance (number of cycles) |
|-----------------|-----------------|---------------------------------|------|------|-------------------------|----------------------------------|------------------------------|
| $\varnothing C$ | $\varnothing F$ | Core section (mm ²) | | AWG | | | |
| | | min | Max. | | | | |
| 0.7 | 1.0 | - | 0.3 | 22.0 | 7.0 | 5.0 | 500 Max. |
| 0.9 | 0.8 | - | 0.21 | 24 | 10 | 3.5 | > 1000 |
| 1.3 | 1.1 | - | 0.60 | 20 | 15 | 3 | > 1000 |
| 1.6 | 1.5 | - | 0.93 | 18 | 17 | 2.5 | > 1000 |
| 2 | 1.9 | - | 1.34 | 16 | 30 | 2.5 | > 1000 |

The conductor bucket on the solder contacts is designed with an angle to form a cup into which the solder can flow easily.

• Fixed contacts

Solder contacts



| Contact | | Shell size | Usable cables | | Max. current rating (A) | Contact resistance (m Ω) | Endurance (number of cycles) |
|-----------------|-----------------|---------------|---------------------------------|-----|-------------------------|----------------------------------|------------------------------|
| $\varnothing C$ | $\varnothing F$ | | Core section (mm ²) | AWG | | | |
| 0.5 | 0.4 | 00 | 0.06 | 30 | 5 | 10 | > 1000 |
| | 0.5 | 0 - 1 | 0.096 | 28 | | | |
| 0.7 | 0.63 | 0 - 1 - 2 - 3 | 0.15 | 26 | 7 | 5 | > 1000 |

Contacts for PCB



| Contacts for PCB | | Contact length dimensions "L" | |
|--------------------------------------|--|--|--|
| PCB tail length size 0 | | dimension "L" 5.5 mm | |
| 0.7 mm female PCB tail length size 0 | | dimension "L" 3.5 mm | |
| 0.7 mm female PCB tail length size 1 | | dimension "L" 4.0 mm | |
| 0.7 mm female PCB tail length size 2 | | dimension "L" 6.0 mm | |
| 0.7 mm female PCB tail length size 3 | | dimension "L" 6.0 mm | |
| 0.9 mm female PCB tail length size 0 | | dimension "L" 3.5 mm | |
| 0.9 mm female PCB tail length size 1 | | dimension "L" 4.0 mm | |
| 0.9 mm female PCB tail length size 2 | | dimension "L" 6.0 mm | |
| 4.3 mm female PCB tail length size 1 | | dimension "L" 4.0 mm, dimension "F" 0.7 mm | |
| 1.3 mm female PCB tail length size 2 | | dimension "L" 6.0 mm, dimension "F" 0.7 mm | |
| 1.3 mm female PCB tail length size 3 | | dimension "L" 6.0 mm, dimension "F" 0.7 mm | |

JBX Series



Wiring and assembly instructions

• Cable stripping for connectors with crimp contacts



| Shell size | Ø contacts | Ø I | Stripping for FD, SR, PC | | | Stripping for FC | | |
|------------|------------|--------|--------------------------|-----|----|------------------|-----|----|
| | | | L | C | T | L | C | T |
| 0 | 0.7 | ≤ 1.35 | 15 | 4 | 7 | 19 | 4 | 7 |
| | | > 1.35 | | 5.5 | | | 5.5 | |
| | 0.9 | ≤ 1.6 | 15 | 4 | 7 | 19 | 4 | 7 |
| | | > 1.6 | | 5.5 | | | 5.5 | |
| 1 | 0.7 | ≤ 1.35 | 16 | 4 | 8 | 22 | 4 | 8 |
| | | > 1.35 | | 5.5 | | | 5.5 | |
| | 0.9 | ≤ 1.6 | 16 | 4 | 8 | 22 | 4 | 8 |
| | > 1.6 | 5.5 | | 5.5 | | | | |
| 2 | 0.7 | ≤ 2.1 | 16 | 4 | 8 | 22 | 4 | 8 |
| | | > 2.1 | | 5.5 | | | 5.5 | |
| | 0.9 | ≤ 1.6 | 19 | 4 | 9 | 28 | 4 | 9 |
| | | > 1.6 | | 5.5 | | | 5.5 | |
| 1.3 | ≤ 2.1 | 19 | 4 | 9 | 28 | 4 | 9 | |
| | > 2.1 | | 5.5 | | | 5.5 | | |
| 3 | 0.7 | ≤ 1.35 | 25 | 4 | 10 | 35 | 4 | 10 |
| | | > 1.35 | | 7 | | | 7 | |
| | 0.9 | ≤ 1.6 | 25 | 4 | 10 | 35 | 4 | 10 |
| | | > 1.6 | | 7 | | | 7 | |
| 1.3 | ≤ 2.1 | 25 | 4 | 10 | 35 | 4 | 10 | |
| | > 2.1 | | 7 | | | 7 | | |
| 2 | 1.6 | ≤ 2.6 | 21 | 5.5 | 9 | 28 | 5.5 | 9 |
| | | > 2.6 | | 7 | | | 7 | |
| | 2.0 | ≤ 3.2 | 21 | 5.5 | 9 | 28 | 5.5 | 9 |
| | | > 3.2 | | 7 | | | 7 | |

• Cable stripping for connectors with solder contacts



| Shell size | Ø Contacts | Stripping for FD, SR, PC | | | Stripping for FC | | |
|------------|------------|--------------------------|-----|----|------------------|-----|----|
| | | L | S | T | L | S | T |
| 00 | 0.5 | 9 | 2 | 4 | / | / | / |
| 0 | 0.5 | 11 | 2 | 7 | 16 | 2 | 7 |
| | 0.7 | 12 | 3 | 7 | 16 | 3 | 7 |
| 1 | 0.9 | 12 | 3 | 7 | 16 | 3 | 7 |
| | 0.5 | 12 | 2 | 8 | 19 | 2 | 8 |
| | 0.7 | 13 | 3 | 8 | 19 | 3 | 8 |
| 2 | 0.9 | 13 | 3 | 8 | 19 | 3 | 8 |
| | 1.3 | 13 | 3.5 | 8 | 19 | 3.5 | 8 |
| | 0.7 | 16 | 3 | 9 | 25 | 3 | 9 |
| | 0.9 | 16 | 3 | 9 | 25 | 3 | 9 |
| 3 | 1.3 | 16 | 3.5 | 9 | 25 | 3.5 | 9 |
| | 1.6 | 18 | 4 | 9 | 25 | 4 | 9 |
| | 2 | 18 | 4 | 9 | 25 | 4 | 9 |
| 3 | 0.7 | 20 | 3 | 10 | 30 | 3 | 10 |
| | 0.9 | 20 | 3 | 10 | 30 | 3 | 10 |
| | 1.3 | 20 | 3.5 | 10 | 30 | 3.5 | 10 |
| | 1.6 | 22 | 4 | 10 | 30 | 4 | 10 |
| | 2 | 22 | 4 | 10 | 30 | 4 | 10 |



Wiring and assembly instructions : STRAIGHT PLUG



• Connector preparation

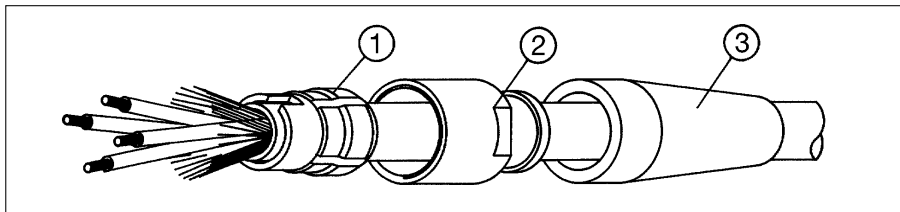

- 1 - Select the proper collet. (see page 19)
- 2 - Slide the protective boot ③ the backnut ② and the collet ① over the cable. Strip end of cable (see pg. 17).
- 3 - If a shielded cable is used fold the braid back over the collet.

• Contacts wiring : crimp contacts

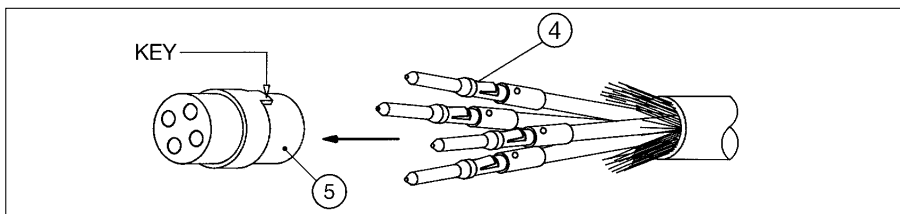

- 1 - Select the proper crimping tool and locator. (see page 48)
- 2 - Adjust the crimping tool based on wire size "AWG". (See wire size and crimp tool settings on the back of the locator)
- 3 - Crimp the contacts ④ then insert the contact into the insulator until the clip is fully seated and cannot be removed.

• Contacts wiring : solder contacts

| Fixed solder contacts 0.5 mm and 0.7 mm | Removable solder contacts from 0.9 mm to 2 mm |
|---|--|
| 1 - Insert wire into solder cup and solder. | 1 - Insert wire into solder cup and solder. 2 - Insert contact into the insulator until the clip is fully seated and cannot be removed. |

• Connector assembly

- 1 - Position 2 half bushings ⑥ on either side of the insulator.
- 2 - Confirm that the key on the insulator ⑤ appears through the window in the one half bushing.
- 3 - Align the key slot on the collet with the keys on the half bushings.
- 4 - Insure the cable shield is still folded back and under the collet.
- 5 - Insert the insulator subassembly ① ④ ⑤ & ⑥ into the connector housing ⑦.
- 6 - Make sure the window on the half bushing ⑥ is aligned with the key way on the connector housing ⑦.
- 7 - Apply thread lock to back nut ②.
- 8 - Attach the back nut to the connector housing ⑦
- 9 - Use the correct size wrench, see page 19.
- 10 - Place the wrenches on the flats A and B. Tighten the back nut ② per the torque spec on page 19.
- 11 - Install the protective boot if applicable.



JBX Series



Wiring and assembly instructions : 90° ELBOW PLUG



• Connector preparation



- 1 - Select the proper collet (see page 19).
- 2 - Slide the protective boot ④, the backnut ③, the collet ② and the elbow outlet ① over the cable. Strip end of cable (see pg. 17).
- 3 - If a shielded cable is used, fold the braid back over the collet ②.
- 4 - Align the keys in the elbow outlet ① with the key slot in the collet.
- 5 - Apply thread lock to the backnut ③.
- 6 - Install the back nut ③ and tighten until it bottoms.

• Contacts wiring : crimp contacts



- 1 - Select the proper crimping tool and locator. (see page 48)
- 2 - Adjust the crimping tool based on wire size "AWG". (See wire size and crimp tool settings on the back of the locator)
- 3 - Crimp the contacts ④ then insert the contact into the insulator until the clip is fully seated and cannot be removed.

• Contacts wiring : solder contacts

| Fixed solder contacts 0.5 mm and 0.7 mm | Removable solder contacts from 0.9 mm to 2 mm |
|---|--|
| 1 - Insert wire into solder cup and solder. | 1 - Insert wire into solder cup and solder. 2 - Insert contact into the insulator until the clip is fully seated and cannot be removed. |

• Connector assembly : 90 degree plug



- 1 - Position the ring ⑦ over the insulator.
- 2 - Align the key on the insulator ⑤ with the key way on the spacer ⑧ and insert the insulator into the spacer.
- 3 - Insert the insulator sub-assembly into the connector housing ⑨ insuring the flats on the elbow outlet ① are facing the retaining nut ⑩.
- 4 - Apply thread lock to retaining nut ⑩.
- 5 - Tighten the retaining nut ⑩ to the recommended torque on page 19.



Wiring and assembly instructions

• Collet selection according to cable diameters

4 or 6 collets per shell size are supplied to allow the use of a wide range of cable diameters for each connector. The cable diameters given on this chart are the minimum and maximum diameters of cable jacket.



| Collet number | Cable diameter | | | | |
|---------------|----------------|--------------|--------------|--------------|--------------|
| | Shell size 00 | Shell size 0 | Shell size 1 | Shell size 2 | Shell size 3 |
| 1 | 1.1 - 1.9 | 1.5 - 2.5 | 2.0 - 2.5 | 3.5 - 4.7 | 4.9 - 6 |
| 2 | 2 - 2.8 | 2.6 - 3.5 | 2.6 - 3.5 | 4.8 - 5.7 | 6.1 - 7.2 |
| 3 | 2.9 - 3.5 | 3.6 - 4.5 | 3.6 - 4.5 | 5.8 - 6.7 | 7.3 - 8.4 |
| 4 | - | 4.6 - 5.5 | 4.6 - 5.5 | 6.8 - 7.7 | 8.5 - 9.6 |
| 5 | - | - | 5.6 - 6.6 | 7.8 - 8.7 | 9.7 - 10.8 |
| 6 | - | - | 6.7 - 7.5 | 8.8 - 9.7 | 10.9 - 12.0 |

*Cable jacket must be inserted at least halfway through the collet.

Metal collets are available as an option in size 0, 1, 2, & 3.

• Coupling torques

| Tools (jaw dimensions) | 7 x 0.5 | 9 x 0.6 | 12 x 1 | 15 x 1 | 18 x 1 | Advised torques* in Nm | | | | |
|---------------------------|---------|---------|--------|--------|--------|------------------------|------------|-----|------------|---|
| | 00 | 0 | 1 | 2 | 3 | 00 | 0 | 1 | 2 | 3 |
| | 7 | 11 | 14 | 17 | 21 | 0.5 | 0.7 | 1.3 | 1.7 | 2 |
| | 6 | 8 | 10 | 13 | 15 | 0.7 | 0.8 | 1 | 1.5 | 2 |
| | 6 | 9 | 11 | 14 | 16 | 0.7 | 0.8 | 1 | 1.5 | 2 |
| | - | 10 | 12 | 15 | 17 | - | 0.4 to 0.5 | | 0.5 to 0.7 | |
| | - | 10 | 13 | 17 | 20 | 0.5 | 0.7 | 1.3 | 1.7 | 2 |
| | - | 9 | 13 | 15 | - | - | - | - | - | - |

Torque values are the maximum allowable for each connector size.

Torque values will vary due to the type and size of the cable used

*Apply thread lock to back nut prior to assembly.

Note : All the tooling numbers refer to the drawings pages 7 and 8.

• Shielding

Tested according to MIL-STD 1344 A, method 3007



| Shell size | Electrical continuity (mΩ) |
|------------|----------------------------|
| 00 | 4.5 |
| 0 | 4 |
| 1 | 3 |
| 2 | 2.5 |
| 3 | 2.5 |

Metal collet available for all sizes



Discreet application based on cable diameter.

JAX Series



Key features

- Hermaphroditic insert : prevents mismatings.
- Multipin connectors : contact layouts from 1 to 14.
- Wire gauges range from 26 AWG to 16 AWG.
- High contact density in a small space.
- Coaxial contacts : 50 Ω and 75 Ω impedance.



User advantages

Large range of blind mate coaxial connectors



Part number system

| | | | | | | |
|--|---|---|---|----|------|---|
| Basic series | JAX | F | 2 | M3 | D080 | B |
| Shell type | F - RA - PC | | | | | |
| Shell size | 00 - 0 - 1 - 2 - 3 | | | | | |
| Contact layout | - multi contacts : see designation table page 22 - coaxial : see designation table page 22 | | | | | |
| Suffix for cable outside diameter, see table page 23 | | | | | | |
| B : obligatory suffix | | | | | | |

JAX Series



Shell types



Dimensions

Straight plug - ref. F



| Size | 00 | 0 | 1 | 2 | 3 |
|------------------------|-----|-----|-----|-----|------|
| A | 25 | 34 | 43 | 51 | 61 |
| \varnothing B | 6.5 | 9 | 12 | 15 | 18 |
| \varnothing C | 3.2 | 4.2 | 6.2 | 8.2 | 11.2 |
| \varnothing c | 2.2 | 2.2 | 2.2 | 4.2 | 4.2 |
| D | 17 | 24 | 32 | 39 | 46 |

Round flange - ref. RA



| Size | 00 | 0 | 1 | 2 | 3 |
|------------------------|----------|----------|---------|---------|---------|
| A | 11 | 13.3 | 15 | 16.5 | 20.5 |
| \varnothing B | 8 | 10 | 14 | 18 | 22 |
| \varnothing C | M7 x 0.5 | M9 x 0.6 | M12 x 1 | M15 x 1 | M18 x 1 |
| D | 1 | 1.2 | 1.5 | 1.8 | 2 |
| E | 6.5 | 7 | 8 | 8 | 11 |
| \varnothing F | 7.1 | 9.2 | 12.2 | 15.2 | 18.2 |
| G | 3.5 | 3.5 | 3 | 5 | 4.5 |
| K | 9 | 11 | 14 | 17 | 21 |
| \varnothing M | 6 | 8 | 10 | 13 | 16 |
| L | 6.4 | 8.3 | 10.6 | 13.6 | 16.6 |

In line plug - ref. PC



| Size | 00 | 0 | 1 | 2 | 3 |
|----------|-----|-----|-----|-----|------|
| A | 24 | 33 | 40 | 49 | 59 |
| B | 6.5 | 9 | 12 | 15 | 18 |
| C | 3.2 | 4.2 | 6.2 | 8.2 | 11.2 |
| c | 2.2 | 2.2 | 2.2 | 4.2 | 4.2 |

JAX Series





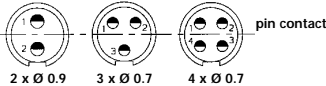
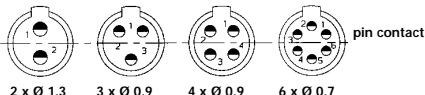
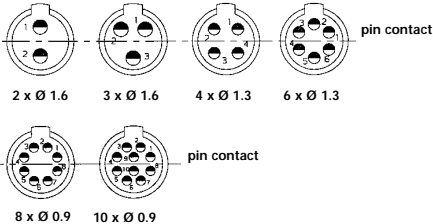
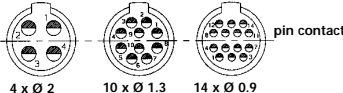

Contact layouts

• Multi contacts inserts

| Shell size | Plug insulator viewed from wiring side | Contact layout | Designation | Ø Contact | Max current rating (A) | Testing voltage (Vrms) | Working voltage (Vdc / Vrms) |
|------------|--|----------------|------------------------------|-----------|------------------------|------------------------|------------------------------|
| 00 |  1 x Ø 1.3 | 1 | UM (plug) UF (receptacle) | 1.3 | 8 | 900 | 400 / 300 |
| 0 |  | 2 | M2 | 0.9 | 10 | 1500 | 700 / 500 |
| | | 3 | M3 | 0.7 | 7 | 1050 | 500 / 350 |
| | | 4 | M4 | 0.7 | 7 | 1050 | 500 / 350 |
| 1 |  | 2 | M2 | 1.3 | 15 | 1200 | 600 / 400 |
| | | 3 | M3 | 0.9 | 10 | 1200 | 600 / 400 |
| | | 4 | M4 | 0.9 | 10 | 1200 | 600 / 400 |
| | | 6 | M6 | 0.7 | 7 | 1200 | 600 / 400 |
| 2 |  | 2 | M2 | 1.6 | 20 | 1800 | 600 / 400 |
| | | 3 | M3 | 1.6 | 15 | 1500 | 600 / 400 |
| | | 4 | M4 | 1.3 | 15 | 1500 | 600 / 400 |
| | | 6 | M6 | 1.3 | 12 | 1500 | 600 / 400 |
| | | 8 | M8 | 0.9 | 9 | 750 | 800 / 600 |
| | | 10 | M10 | 0.9 | 7 | 750 | 700 / 500 |
| 3 |  | 4 | M4 | 2 | 18 | 1500 | 700 / 500 |
| | | 10 | M10 | 1.3 | 9 | 1050 | 500 / 350 |
| | | 14 | M14 | 0.9 | 7 | 1050 | 500 / 350 |

Designation to use in the part-number system, page 20

• Coaxial inserts

| Shell size | Insulator | Contact impedance (Ω) | Designation | Ø Contact | Max current rating (A) | Testing voltage (Vrms) | Working voltage (Vdc / Vrms) |
|------------|---|-----------------------|-------------|-----------|------------------------|------------------------|------------------------------|
| 00 |  | 50 | C50 | 0.7 | 5 | 1800 | 800 / 600 |
| 0 |  | 50 | C50 | 1.3 | 10 | 2300 | 1100 / 780 |
| | | 50S | C50S | 0.9 | 6 | 2300 | 1100 / 780 |
| 1 |  | 50 | C50 | 1.6 | 12 | 2300 | 1100 / 780 |
| | | 75 | C75 | 1.3 | 10 | 2900 | 1400 / 980 |
| 2 |  | 50 | C50 | 2 | 15 | 2900 | 1400 / 980 |
| | | 75 | C75 | 1.6 | 12 | 3900 | 1800 / 1300 |
| 3 |  | 50 | C50 | 3 | 26 | 5700 | 2800 / 1900 |
| | | 75 | C75 | 2 | 15 | 6300 | 3000 / 2100 |

Designation to use in the part-number system, page 20.

JAX Series



Suffix for cable outside diameter

| Shell size | Accommodation of cable diameter | Obligatory suffix |
|------------|--|--|
| 00 | From 1.5 mm to 2.2 mm From 2 mm to 3.2 mm | D020 D030 |
| 0 | From 2 mm to 3.2 mm From 3 mm to 4.2 mm | D030 D040 |
| 1 | From 2 mm to 3.2 mm From 3 mm to 4.2 mm From 4 mm to 5.2 mm From 5 mm to 6.2 mm | D030 D040 D050 D060 |
| 2 | From 4 mm to 5.2 mm From 5 mm to 6.2 mm From 6 mm to 7.2 mm From 7 mm to 8.2 mm | D050 D060 D070 D080 |
| 3 | From 4 mm to 5.2 mm From 5 mm to 6.2 mm From 6 mm to 7.2 mm From 7 mm to 8.2 mm From 8 mm to 9.2 mm From 9 mm to 10.2 mm From 10 mm to 11.2 mm | D050 D060 D070 D080 D090 D100 D110 |

Designation to use in the part number system, page 20

Options

• Caps



| Part number | A | B | C | D |
|-------------|----|----|----|----|
| JAX RA 120 | 12 | 11 | 20 | 70 |
| JAX RA 220 | 15 | 11 | 21 | 70 |
| JAX RA 320 | 18 | 14 | 26 | 70 |

Material: Nickel-chromium brass. Neoprene seal.



Technical characteristics

• Material and treatment

| Component | Material | Standard | | Surface treatment (µm) | | |
|----------------------------|--------------|-----------|--------|------------------------|-------|-----|
| | | ISO | ASTM | Cr | Ni | Au |
| Outer shell and collet nut | Brass | CuZn40Pb3 | C38500 | 0.1 - 0.6 | 5 - 8 | - |
| Latching sleeve | Brass | CuZn40Pb3 | C38500 | - | 5 - 8 | - |
| Shielding ring | Brass | CuZn40Pb3 | C38500 | - | 3 - 7 | - |
| Nut | Brass | CuZn40Pb3 | C38500 | - | 5 - 8 | - |
| Half bushes | Brass | CuZn40Pb3 | C38500 | - | 5 - 8 | - |
| Socket contact (1) | Cupro-nickel | CuNi1Pb1P | - | - | 3 - 5 | 0.5 |
| Pin contact (1) | Brass | CuZn35Pb2 | C35300 | - | 3 - 5 | 0.5 |

(1) Gold thickness as per MIL-G-45204C type 1, class 00.

| Component | Material | Color | Temperature withstanding | |
|-----------|-------------------------------------|-------|--------------------------|------------------|
| | | | | |
| Insert | TEFZEL (coaxial connector) | White | - 70°C ; + 150°C | - 94°F ; + 302°F |
| | Nylatron GS (multipin connector) | Grey | - 40°C ; + 125°C | - 40°F ; + 257°F |

• Mechanical and climatics

| Characteristics | Values | Standard |
|-----------------------|-------------------------------------|----------|
| Endurance | 1000 cycles | |
| Protection index | IP 40 | CEI 529 |
| Operating temperature | - 40°C ; + 125°C / - 40°F ; + 257°F | |

JAX Camac Series



These 2 pages describe the JAX Camac series, size 00. These connectors are often used on jumpers for delay lines in Nuclear Physics due to their size and simple handling in congested areas. For Nuclear Physics, our connectors meet the standard NIM-CAMAC*. Moreover, JAX coaxial connectors are suitable for many other industrial and scientific applications such as medical, microwave communications, pocket transmitters, input/output on electronic modules.

NIM-CAMAC* configuration (4 GHz - 50 Ω)



* NIM-CAMAC : Nuclear Instrumentation Module / Computer Automated Measurement and Control

Dimensions and part-numbers

P/N : JAX F 00 C50 RG 174 US
Straight plug for RG174U cable

Weight : 3.5 g

P/N : JAX RA 00 C50S
Fixed front flange receptacle, solder contacts

Weight : 2.5 g

P/N : JAX 00 MDPN
Protective boot

Cable \varnothing =
min = 1
max = 3.8

Weight : 0.2 g
Temperature = - 40°C ; + 80°C

P/N : JAX RA 0018
RF screening cap

Weight : 1.5 g

Technical data



| Specific characteristics | Values |
|--------------------------|--------------------------------------|
| Endurance | 5000 cycles |
| Operating temperature | - 70°C ; + 200°C - 94°F ; + 392°F |
| Plating on metal shell | Ni = 3 - 7 μm |
| Insert | PTFE |

JAX Camac Series



Delay lines

- **Cable Nr 96-CEI-50-2-1 (RG 174U)**
fitted with NIM-CAMAC connectors at both ends



L : Length which defines delay in ns of cable jumpers

| P/N | Delay (ns) | Tolerance (%) | L * |
|-----------------------|------------|---------------|------|
| JAX L 00 C50 C11 R005 | 0.5 | 5 | 100 |
| JAX L 00 C50 C11 R010 | 1 | 5 | 200 |
| JAX L 00 C50 C11 R020 | 2 | 2.5 | 400 |
| JAX L 00 C50 C11 R030 | 3 | 1.7 | 600 |
| JAX L 00 C50 C11 R040 | 4 | 1.3 | 800 |
| JAX L 00 C50 C11 R050 | 5 | 1 | 1000 |
| JAX L 00 C50 C11 R060 | 6 | 1 | 1200 |
| JAX L 00 C50 C11 R080 | 8 | 1 | 1600 |
| JAX L 00 C50 C11 R100 | 10 | 1 | 2000 |
| JAX L 00 C50 C11 R160 | 16 | 0.6 | 3200 |

* Average length, for information only

• Crimping tool





Wiring and assembly instructions

• Panel cutout



| Size | 00 | 0 | 1 | 2 | 3 |
|------|-----|-----|------|------|------|
| A | 7.1 | 9.1 | 12.1 | 15.1 | 18.1 |
| B | 6.4 | 8.3 | 10.6 | 13.6 | 16.6 |

• Contacts



| \varnothing Contact | Usable cables (AWG) | $\varnothing F$ |
|-----------------------|---------------------|-----------------|
| 0.7 | 26 | 0.6 |
| 0.9 | 24 | 0.8 |
| 1.3 | 20 | 1.1 |
| 1.6 | 18 | 1.5 |
| 2.0 | 16 | 1.9 |

• Cable stripping for connectors with multi contacts (solder contacts)



| Size | A | B | C * |
|------|----|---|-----|
| 0 | 9 | 4 | 7 |
| 1 | 12 | 4 | 8 |
| 2 | 17 | 4 | 9 |
| 3 | 19 | 4 | 10 |

* If shielded cable

• Cable stripping for connectors with coaxial contacts / single contacts



| Size | A | B | C |
|------|------|-----|----|
| 00 | 15 | 4 | 15 |
| 0 | 15.5 | 4.5 | 6 |
| 1 | 18.5 | 6.5 | 6 |
| 2 | 25 | 7 | 7 |
| 3 | 23 | 7.5 | 10 |

JAX Series



Wiring and assembly instructions : MULTIPIN PLUGS SIZES 0, 1, 2, 3



• **Cable stripping** : see page 27

• **Connector preparation and contacts wiring**



1 - Slide the backnut and the collet onto the cable.

2 - Terminate the bucket contacts using solder method.

• **Connector assembly**



3 - For shielded cable : pull back the collet up to external sheath extremity.

4 - Comb out the screen and fold back over the collet end.

5 - Position two half bushes on the insert, taking care of a proper positioning of the key.



6 - Slide in the insert assembly into the plug (or the free receptacle) shell.

Note : the collet key may be properly set into shells key ways.

7 - Install the backnut and screw it.



Wiring and assembly instructions : COAXIAL PLUGS

• **Cable stripping** : see page 27

• **Connector assembly**



Note :

- Take care to align cone key inside the sub-assembly rear key way.
- The stripped core end may be visible inside pin contact front window.

Remark : For size 00, no cone existing : sub-assembly directly onto collet.



Wiring and assembly instructions : SINGLE PIN PLUGS

• **Cable stripping** : see page 27

• **Connector assembly**

Monolithic insert is directly soldered onto the inner core.



- 1 - Slide the backnut and the collet onto the cable.
- 2 - Position the intermediate cone in abutment on external sheath extremity
- 3 - Brush back the screen around the cone
- 4 - Pull back the collet onto the cone
- 5 - Position the rear insulator sub-assembly on the cone

- 6 - Solder inner core thru the pin window
- 7 - Set in place the front insulator, taking care of the key/keyway positioning between the two half insert sub-assembly

- 8 - Slide in the insert assembly into the plug (or free receptacle shells)
- 9 - Install the nut and screw it





Wiring and assembly instructions : Crimp contact (NIM-CAMAC configuration)

• Wiring preparation

- 1 - Slide the protective boot and the crimping ferrule onto the cable

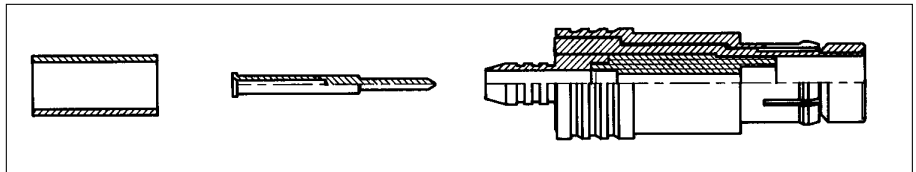

• Coaxial cable stripping

- 1 - Strip the coaxial cable according to the lengths given on the drawing

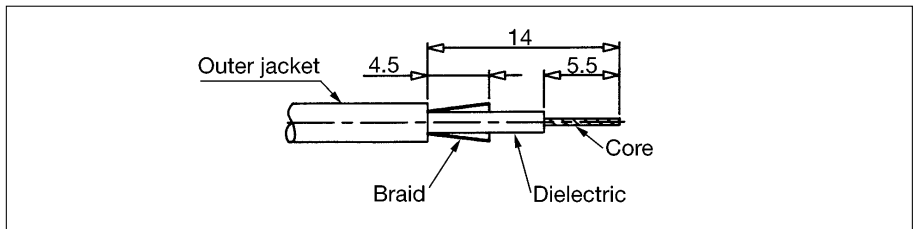

• Contact crimping

- 1 - Take the crimping tool P/N : JX2 W 1010 A9
- 2 - Crimp the contact

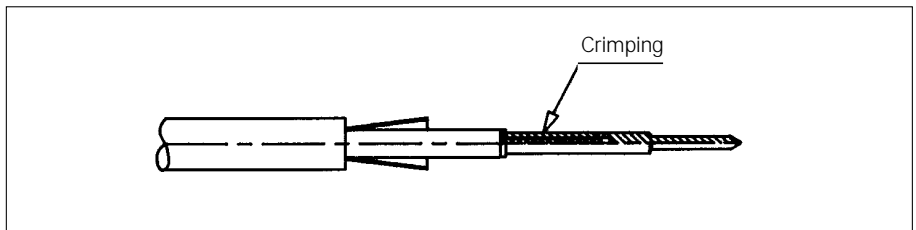

• Connector assembly

- 1 - Position the crimp contact then engage the insert cavity until it bottoms
- 2 - Fold the screen over the connector outlet
- 3 - Position the ferrule on the screen then crimp it

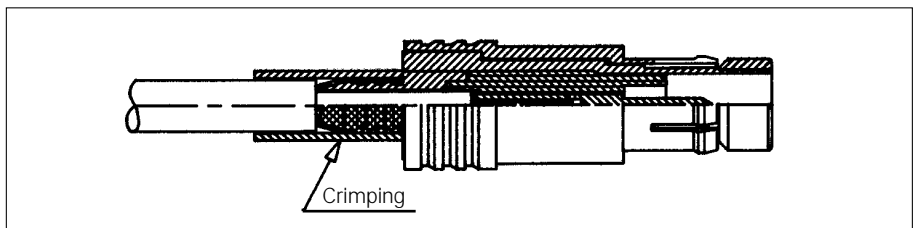

- 4 - Slide the protective boot and then position on the connector outershell

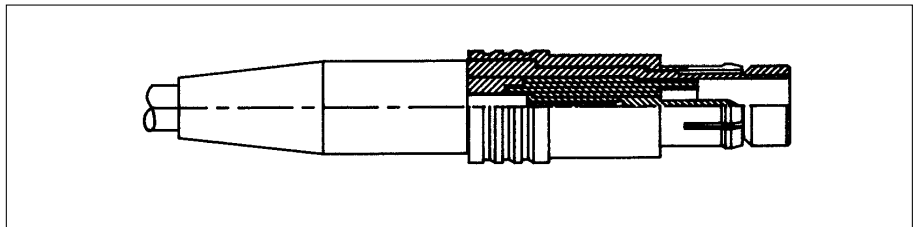

JKX Series



Key features

- Sealed IP 68 (mated connectors)
- Mechanically keyed : ensures correct polarization and alignment.
- Contact arrangements : from 2 to 10 contacts.
- Wire gauge range from 28 AWG to 14 AWG.
- High contact density in a small space.
- Contact termination in either crimp, solder or PCB contacts.



User advantages

Temporary immersion IP 68



6-collet cluster

Allows a wide range of cable diameter applications for a single connector.
Reduces inventory variations.

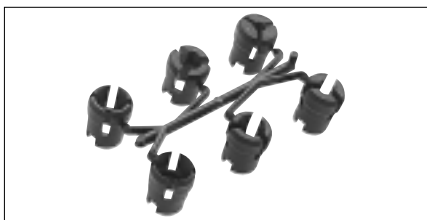

Removable contacts

Crimp versions allow easier wiring and maintenance.

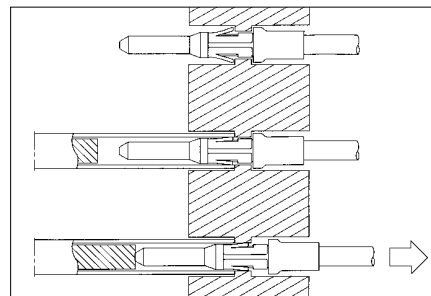

Part number system

| | | | | | | | | | | | |
|----------------------------|---|-----------|----------|----------|-----------|----------|----------|----------|----------|----------|----------|
| Basic series | JKX | FD | 1 | G | 05 | M | C | S | D | S | M |
| Shell configuration | FD - ER - EP - PC | | | | | | | | | | |
| Size | 0 - 1 | | | | | | | | | | |
| Keying | G | | | | | | | | | | |
| Contact layouts | 02 ----- 10 (see page 33) | | | | | | | | | | |
| Contact type | M : pin F : socket (in relation with keying) | | | | | | | | | | |
| Contact termination | C : crimp ; S : solder ; P* : straight PCB tails ; Q* : 90° PCB tails ; W : 0.7 mm clipped solder | | | | | | | | | | |
| Material & surface plating | S : Outer shell in brass alloy with glossy chrome over nickel N : Outer shell in brass alloy with black plating (consult us) D : Obligatory suffix S : Insulator in PPS P : Insulator in Peek (for Ø 0.5 mm contacts only) Obligatory suffix for layouts including contacts of Ø 0.5 mm | | | | | | | | | | |
| Options | M : Connector with backnut for protective boot (protective boot to order separately page 34) G : Connector adapted to accommodate larger cables (Ø 4.5 to 6 in size 0 and Ø 6 to 8 in size 1) R : Red dot (possible for FD, PC, ER only) | | | | | | | | | | |

* For receptacles with female contacts only.

JKX Series



Shell type

- Available JKX shells



• Dimensions

ER : Fixed receptacle, front panel mounting

| Size | A | B | C | Ø D |
|------|------|-----|-----|-----|
| 0 | 19.5 | 4.5 | 4 | 18 |
| 1 | 24.5 | 8.5 | 4.5 | 20 |

FD : Straight plug with cable clamping

| Size | A | Ø B | Ø M |
|------|----|-----|------------|
| 0 | 47 | 12 | 1.5 to 4.5 |
| 1 | 57 | 15 | 2 to 6 |

EP : Fixed receptacle, back panel mounting

| Size | A | B | C | Ø D |
|------|------|-----|-----|-----|
| 0 | 19.5 | 4.5 | 3.2 | 18 |
| 1 | 24.5 | 6 | 4 | 20 |

PC : Cable mounted receptacle

| Size | A | Ø B | Ø C |
|------|----|-----|--------|
| 0 | – | – | – |
| 1 | 60 | 16 | 2 to 6 |

- Option G : to accomodate bigger cables



| Size | A | Ø B | Ø M |
|------|----|-----|----------|
| 0 | 51 | 12 | 4.6 to 6 |
| 1 | 60 | 15 | 6 to 8 |

JKX Series



Keying

G keying is available in standard version (0° keying angle, plugs with pin contacts, receptacles with female contacts) for the 4 shell types. Reverse gender available in all layouts.

| Shell size | Key | ER | EP | PC | FD |
|------------|-----|----|----|----|----|
| 0 | G | ● | ● | - | ● |
| 1 | G | ● | ● | ● | ● |

● Concerning the availability of other alternatives, please consult our commercial office.

Contacts

• Multi contacts inserts

| Shell size | Male insulator viewed from wiring side | Contact layout | Available Contact types | | | | ∅ Contact | AWG | | Max. current rating (A) | Testing voltage (Vrms) | Working voltage (Vdc / Vrms) |
|------------|--|----------------|-------------------------|---------|-----------------------|------------------|-----------|------------------|-----------------|-------------------------|------------------------|------------------------------|
| | | | S solder | C crimp | P* straight PCB tails | Q* 90° PCB tails | | Solder wire Max. | Crimp wire Max. | | | |
| 0 | | 02 | S | C | P | Q | 0.9 | 24 | 20 | 10 | 1400 | 660/460 |
| | | 03 | S | C | P | Q | 0.9 | 24 | 20 | 8 | 1300 | 600/420 |
| | | 04 | S | C | P | Q | 0.7 | 26 | 22 | 7 | 1400 | 660/460 |
| | | 05 | S | C | P | Q | 0.7 | 26 | 22 | 6.5 | 800 | 400/260 |
| | | 06 | S | | P | | 0.5 | 28 | - | 2.5 | 680 | 320/220 |
| | | 07 | S | | P | | 0.5 | 28 | - | 2.5 | 680 | 320/220 |
| 1 | | 02 | S | C | P | | 1.3 | 20 | 18 | 15 | 1600 | 760/530 |
| | | 03 | S | C | P | Q | 1.3 | 20 | 18 | 12 | 1300 | 600/420 |
| | | 04 | S | C | P | Q | 0.9 | 24 | 20 | 10 | 1900 | 900/630 |
| | | 05 | S | C | P | Q | 0.9 | 24 | 20 | 9 | 1400 | 660/460 |
| | | 06 | S | C | P | Q | 0.7 | 26 | 22 | 7 | 1400 | 660/460 |
| | | 07 | S | C | P | Q | 0.7 | 26 | 22 | 7 | 1400 | 660/460 |
| | | 08 | S | C | P | Q | 0.7 | 26 | 22 | 5 | 1200 | 600/420 |
| | | 10 | S | | P | | 0.5 | 28 | - | 2.5 | 600 | 300/200 |

Inserts with fixed contacts (non removable contacts)

* For receptacles with female contacts only

JKX Series



Options

• Protective boot

Protective boot can accept multiple cable diameters



| Part number | Shell size | Shell size Option G | Dimensions | | | |
|-------------|------------|---------------------|------------|----|---------|------|
| | | | Ø A | L | Ø Câble | |
| | | | | | min | Max. |
| JBX 0 MP* | 0 | - | 2.2 | 20 | 1.5 | 5.5 |
| JBX 1 MP* | 1 | 0 | 2.6 | 25 | 2 | 7.5 |
| JBX 2 MP* | - | 1 | 4 | 30 | 3.5 | 9.7 |

* Color code



| Color code | Colors |
|------------|--------|
| A | blue |
| B | white |
| G | grey |
| J | yellow |
| M | brown |
| N | black |
| R | red |
| V | green |
| O | orange |

Material :

ELASTOLLAN (PUR)

Working temperature :

- 40°C ; + 80°C

- 40°F ; + 176°F

With each JKX connector, one protective boot can accept diverse cable diameters thus the end-user can manage various cable diameters without bothering with multiple part numbers.

• Caps : an efficient protection until 2 bars



| Part number | Ø |
|-------------|----|
| JKX BR0 | 15 |
| JKX BR1 | 17 |

JKX Series



Technical characteristics

• Material and treatment

| Component | Material | Standard | | Surface treatment (µm) | | |
|--------------------------------|------------------|-----------|-------------|------------------------|-------|-----|
| | | ISO | ASTM | Cr | Ni | Au |
| Outer shell and collet nut | Brass | CuZn40Pb3 | C38500/C360 | 0.1 - 0.6 | 5 - 8 | - |
| Latching sleeve & metal collet | Brass | CuZn40Pb3 | C38500/C360 | - | 5 - 8 | - |
| Shielding ring | Brass | CuZn40Pb3 | C38500/C360 | - | 3 - 7 | - |
| Nut | Brass | CuZn40Pb3 | C38500/C360 | - | 5 - 8 | - |
| Tapered washer and half bushes | Brass | CuZn40Pb3 | C38500/C360 | - | 5 - 8 | - |
| Socket contact (1) | Copper-nickel | CuNi1Pb1P | CDA C 19150 | - | 3 - 5 | 0.5 |
| Pin contact (1) | Brass | CuZn35Pb2 | C35300/C360 | - | 3 - 5 | 0.5 |
| Clip | Beryllium copper | CuBe1,9 | C17200/C360 | - | - | - |

(1) Gold thickness as per MIL-G-45204C type 1, class 00.

| Component | Material | Color | Temperature withstanding | |
|----------------|--------------------------------|----------------|----------------------------------|----------------------------------|
| Insert | PPS + 40%GF or PEEK + 15%GF | black brown | - 65°C + 200°C - 50°C + 250°C | - 85°F + 392°F - 58°F + 482°F |
| Plastic collet | PA 6/6 + MoS2 | black | - 55°C + 125°C | - 67°F + 257°F |
| Cable seal | Silicon rubber | red | - 50°C + 250°C | - 58°F + 482°F |

• Mechanical and climatics

| Characteristics | Values | Standard | Method |
|-----------------------|---|---------------|--------|
| Endurance | > 1000 cycles (except for 0.7 mm crimp contacts for which endurance is limited to 500 cycles) | MIL-STD 1344A | 2016.1 |
| Shock | 50 g, duration 6 ms ; contact Ø 0.7 mm and 0.9 mm 100 g, duration 6 ms ; contact Ø 1.3 mm - 1.6 mm and 2 mm | MIL-STD 1344A | 2004.1 |
| Vibrations | 10 to 2000 Hz $\gamma = 15$ g, contact Ø 0.7 mm and 0.9 mm $\gamma = 20$ g, contact Ø 1.3 mm - 1.6 mm and 2 mm | MIL-STD 1344A | 2005.1 |
| Protection index | IP 68 (watertight - 48 hours under 1 m of water) | CEI 529 | |
| Operating temperature | with plastic collets } - 55°C + 125°C - 67°F + 257°F | - | - |
| | with optional metal collets } - 55°C + 200°C - 67°F + 392°F | - | - |

JKX Series



Wiring and assembly instructions

• Panel cutout



| Size | 0 | 1 |
|-----------------|------|------|
| $\varnothing A$ | 14.1 | 16.1 |
| B | 12.6 | 14.6 |

• Removable contacts

Crimp contacts



| Contact | | Usable cables | | | Max. current rating (A) | Contact resistance (m Ω) | Endurance (number of cycles) |
|-----------------|-----------------|---------------------------------|-------|--------------|-------------------------|----------------------------------|------------------------------|
| $\varnothing C$ | $\varnothing F$ | Core section (mm ²) | | AWG | | | |
| | | min | Max. | | | | |
| 0.7 | 0.85 | 0.129 | 0.326 | 22 - 24 - 26 | 7 | 5 | 500 Max. |
| 0.9 | 1.1 | 0.205 | 0.518 | 20 - 22 - 24 | 10 | 3.5 | > 1000 |
| 1.3 | 1.4 | 0.326 | 0.823 | 18 - 20 - 22 | 15 | 3 | > 1000 |

Solder contacts



| Contact | | Usable cables | | | Max. current rating (A) | Contact resistance (m Ω) | Endurance (number of cycles) |
|-----------------|-----------------|---------------------------------|------|-----|-------------------------|----------------------------------|------------------------------|
| $\varnothing C$ | $\varnothing F$ | Core section (mm ²) | | AWG | | | |
| | | min | Max. | | | | |
| 0.7 | 1.0 | - | 0.3 | 22 | 7 | 5 | 500 Max. |
| 0.9 | 0.8 | - | 0.21 | 24 | 10 | 3.5 | > 1000 |
| 1.3 | 1.1 | - | 0.60 | 20 | 15 | 3 | > 1000 |

The conductor bucket on the solder contacts is designed with an angle to form a cup into which the solder can flow easily.

• Fixed contacts

Solder contacts

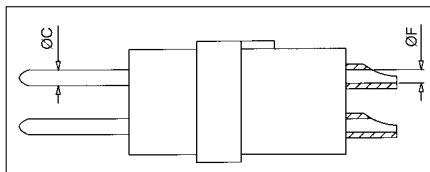

| Contact | | Shell size | Usable cables | | Max. current rating (A) | Contact resistance (m Ω) | Endurance (number of cycles) |
|-----------------|-----------------|------------|--------------------------------------|-----|-------------------------|----------------------------------|------------------------------|
| $\varnothing C$ | $\varnothing F$ | | Core section (mm ²) Max. | AWG | | | |
| 0.5 | 0.5 | 0 - 1 | 0.096 | 28 | 5 | 10 | > 1000 |
| 0.7 | 0.63 | 0 - 1 | 0.15 | 26 | 7 | 5 | > 1000 |

Contacts for PCB

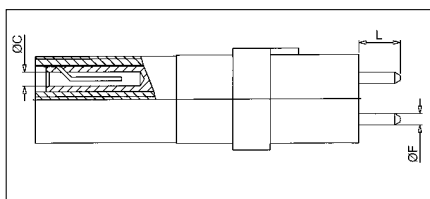

| Contacts for PCB | Contact length dimensions "L" |
|--------------------------------------|--|
| PCB tail length size 0 | dimension "L" 5.5 mm |
| 0.7 mm female PCB tail length size 0 | dimension "L" 3.5 mm |
| 0.7 mm female PCB tail length size 1 | dimension "L" 4.0 mm |
| 0.9 mm female PCB tail length size 0 | dimension "L" 3.5 mm |
| 0.9 mm female PCB tail length size 1 | dimension "L" 4.0 mm |
| 1.3 mm female PCB tail length size 1 | dimension "L" 4.0 mm, dimension "F" 0.7 mm |



Wiring and assembly instructions

• Cable stripping for connectors with crimp contacts



| Shell size | Ø Contacts | Ø I | Stripping for FD / PC | | |
|------------|------------|--------|-----------------------|-----|---|
| | | | L | C | T |
| 0 | 0.7 | ≤ 1.35 | 15 | 4 | 7 |
| | | > 1.35 | | 5.5 | |
| | 0.9 | ≤ 1.6 | 15 | 4 | 7 |
| | | > 1.6 | | 5.5 | |
| 1 | 0.7 | ≤ 1.35 | 17 | 4 | 8 |
| | | > 1.35 | | 5.5 | |
| | 0.9 | ≤ 1.6 | 17 | 4 | 8 |
| | > 1.6 | 5.5 | | | |
| | 1.3 | ≤ 2.1 | 17 | 4 | 8 |
| | | > 2.1 | | 5.5 | |

• Cable stripping for connectors with solder contacts



| Shell size | Ø Contacts | Stripping for FD / PC | | |
|------------|------------|-----------------------|-----|---|
| | | L | S | T |
| 0 | 0.5 | 11 | 2 | 7 |
| | 0.7 | 12 | 3 | 7 |
| | 0.9 | 12 | 3 | 7 |
| 1 | 0.5 | 13 | 2 | 8 |
| | 0.7 | 14 | 3 | 8 |
| | 0.9 | 14 | 3 | 8 |
| | 1.3 | 14 | 3.5 | 8 |

• Watertightness design (mated connectors)



- ① : O-ring for sealing between receptacle and plug shell
- ② : O-ring for sealing between receptacle and panel
- ③ : O-ring for sealing between plug body and backshell
- ④ : seals to accomodate variety of cable diameters

JKX Series



Wiring and assembly instructions : STRAIGHT PLUG

- **Cable stripping** : see page 37



• Connector preparation



- 1 - Select the proper collet ④ and the cable seal ③ (see page 39).
- 2 - Slide protective boot ⑥, the backnut ⑤, the collet ④, the cable seal ③, the outershell ② and the taper seat ① onto the cable. Strip end of cable (see pg. 16)

• Contacts wiring : crimp contacts



- 1 - Select the proper crimping tool (see page 48)
- 2 - Adjust the crimping tool based on the wire size "AWG". (See wire size and crimp tool settings on the back of this locator.)
- 3 - Crimp the contacts ④ then insert the contact into the insulator until the clip is fully seated and cannot be removed.

• Contacts wiring : solder contacts

| Fixed solder contacts 0.5 mm and 0.7 mm | Removable solder contacts from 0.9 mm to 1.3 mm |
|--|---|
| 1 - Insert wire into solder cup and solder | 1 - Insert wire into solder cup and solder 2 - Insert the contact into the insulator until the clip is fully seated and cannot be removed. |

• Connector assembly



- 1 - In case of shielded cable, comb out the shield and fold back over the taper seat ①.
- 2 - Position 2 half bushes ⑨, making sure that the insert key appears through the windows of one bush.
- 3 - Position the taper seat ① on the half bushes ⑨.
- 4 - Position all the sub-assembly in connector housing ⑩, making sure to keep the sub-assembly well aligned.
- 5 - Screw the outershell ② following the torque values on page 39. Install the cable seal ③ and the collet ④ into the outershell ② then screw the backnut ⑤ till bottoming. Use 2 wrenches well positioned on the flats A and B. Place a wrench to grip flats B, use the other wrench to tighten the backnut at the flats A following the torque values on page 39.
- 6 - Install the protective boot ⑥ if applicable.



Wiring and assembly instructions

• Collets selection according to cable diameters

3 or 5 collets per shell size allow a wide range of cable diameters for a single connector. Cable out diameters are for information only, since values will change with each cable construction.



| Collet number | Cable diameter | | | |
|---------------|----------------|------------------|--------------|------------------|
| | Shell size 0 | Size 0, option G | Shell size 1 | Size 1, option G |
| 1 | 1.5 - 2.5 | - | 2 - 2.5 | - |
| 2 | 2.6 - 3.5 | - | 2.6 - 3.5 | - |
| 3 | 3.6 - 4.5 | - | 3.6 - 4.5 | 6.1 - 6.7 |
| 4 | - | 4.6 - 5.5 | 4.6 - 5.5 | 6.8 - 7.7 |
| 5 | - | 5.6 - 6 | 5.6 - 6 | 7.8 - 8 |

Collet number 4 in shell size 0 and collet number 6 in shell size 1 are not used.

• Cable seal selections according to cable size

Discreet application based on cable diameter

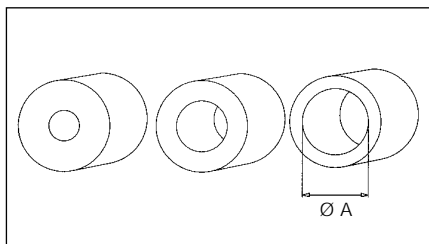

| Cable gland Ø A | Cable diameter | | | |
|--------------------|----------------|------------------|--------------|------------------|
| | Shell size 0 | Size 0, option G | Shell size 1 | Size 1, option G |
| 2 | 1.5 - 2.9 | | | |
| 3.5 | 3 - 4.5 | | | |
| 2.5 | | | 2 - 3.4 | - |
| 4 | | 4.6 - 4.9 | 3.5 - 4.9 | - |
| 5.5 | | 5 - 6 | 5 - 6 | 6.1 - 6.4 |
| 7 | | | | 6.5 - 8 |

• Shielding

Tested according to MIL-STD 1344 A, method 3007

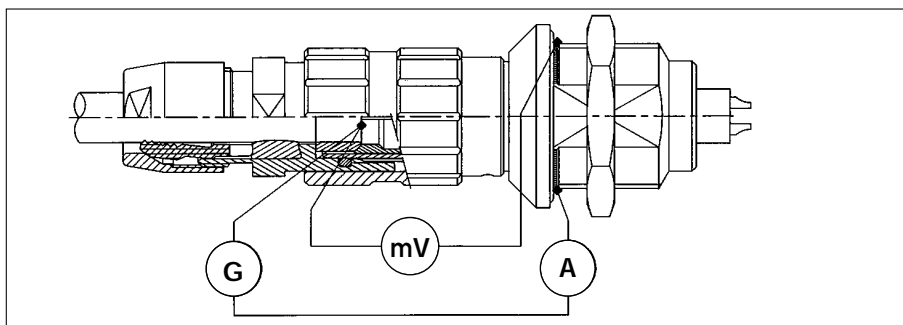

| Shell size | Electrical continuity (mΩ) |
|------------|----------------------------|
| 0 | 4 |
| 1 | 3 |

• Coupling torques

| Size mm | Advised torque* in Nm | | | |
|------------|-----------------------|-----------------|-----|-----------------|
| | 0 | 0 (option G) | 1 | 1 (option G) |
| | 1.6 | / | 1.8 | / |
| | 1.5 | 2 | 2 | 2.5 |
| | 0.8 | 0.8 | 1 | 1 |

Torque values are the maximum allowable for each connector size. Torque values will vary due to the type and size of the cable used

*Apply thread lock to back nut prior to assembly.

Tool dimensions

| Tools (jaw dimensions) | 14 x 1 | | 16 x 1 | |
|---------------------------|--------|-----------------|--------|-----------------|
| | 0 | 0 (option G) | 1 | 1 (option G) |
| | 17 | | 19 | |
| | 8 | 10 | 13 | |
| | 10 | 11 | 12 | 14 |

Tool numbers can be found on page 32

JBX Series sealed version size 2



Key features

- Sealed IP 67 (mated connectors)(FE, EC, SE, & PC)
- Watertight receptacles IP68 (HC & HH)
- Mechanically keyed : ensure correct polarisation and alignment.
- Contact arrangements : from 2 to 19 contacts.
- Wire gauge range from 26 AWG to 12 AWG.
- High contact density in a small space.
- Contact termination in either crimp, solder or PCB contacts.



User advantages

Wet environment IP67



6-collet cluster

Allows a wide range of cable diameter applications for a single connector.
Reduces inventory variations.



Removable contacts (EC, FE, SE & PE)

Crimp versions allow easier wiring and maintenance.

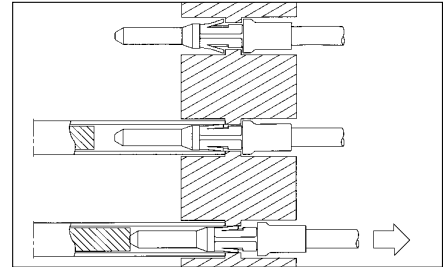

Part number system

| | |
|----------------------------|--|
| Basic series | JBX FE 2 G 12 M C S D S R |
| Shell type | FE-HH-HC-EC-PE-SE |
| Shell size | 2 |
| Keying | G |
| Contact layouts | 02 ----- 19 |
| Contact type | M : pin F : socket (in relation with keying) |
| Contact termination | C : crimp ; S : solder ; P* : straight PCB tails ; Q* : 90° PCB tails |
| Material & surface plating | S : Outer shell in brass alloy with chrome over nickel N : Outer shell in brass alloy with black plating (consult us) D : Obligatory suffix S : Obligatory suffix |
| Option | R : FE, PE, HH, & HC N/A for EC & SE |

* For receptacles with female contacts only.

JBX Series sealed version size 2



Shell type

- Available sealed JBX, Size 2



• Dimensions



JBX Series sealed version size 2



Keying

Only G keying is available in standard version (0° keying angle, plugs with pin contacts, receptacles with female contacts) for the different types of shells.

Contact layouts

• Multi contact inserts

| Shell size | Male insulator viewed from wiring side | Contact layout | Available Contact types | | | | Ø Contact | AWG | | Max. current rating (A)* | Testing voltage (Vrms)* | Working voltage (Vdc / Vrms)* |
|------------|--|----------------|-------------------------|---------|-----------------------|------------------|-----------|------------------|-----------------|--------------------------|-------------------------|-------------------------------|
| | | | S solder | C crimp | P* straight PCB tails | Q* 90° PCB tails | | Solder wire Max. | Crimp wire Max. | | | |
| 2 | | 02 | S | C | | | 2 | 16 | 12 | 30 | 2100 | 1000/700 |
| | | 03 | S | C | | | 1.6 | 18 | 14 | 17 | 1700 | 830/560 |
| | | 04 | S | C | P | Q | 1.3 | 20 | 18 | 15 | 2400 | 1000/800 |
| | | 05 | S | C | P | Q | 1.3 | 20 | 18 | 14 | 1900 | 900/630 |
| | | 06 | S | C | P | Q | 1.3 | 20 | 18 | 12 | 1900 | 900/630 |
| | | 07 | S | C | P | Q | 1.3 | 20 | 18 | 11 | 1500 | 730/500 |
| | | 08 | S | C | P | Q | 0.9 | 24 | 20 | 10 | 1700 | 830/560 |
| | | 10 | S | C | P | Q | 0.9 | 24 | 20 | 8 | 1700 | 830/560 |
| | | 12 | S | C | P | Q | 0.7 | 26 | 22 | 7 | 1700 | 830/560 |
| | | 16 | S | C | P | Q | 0.7 | 26 | 22 | 6 | 1500 | 730/500 |
| | | 18 | S | C | P | | 0.7 | 26 | 22 | 5.5 | 1400 | 660/460 |
| | | 19 | S | C | P | | 0.7 | 26 | 22 | 5 | 1400 | 660/460 |

Inserts with fixed contacts (non removable contacts).

* For EC and HC receptacles with female contacts only.

HH & HC fixed contacts only.

JBX Series sealed version size 2



Technical characteristics

The technical characteristics are the same as for the standard JBX series except the following ones:

• Material - Specific additional elements

| Component | Material | Color | Working temperature | |
|-----------------|------------------|---------------------|---------------------|------------------|
| Seals | Nitrile | O'ring seal = black | - 30°C ; + 250°C | - 58°F ; + 482°F |
| Protective boot | Elastollan (PUR) | Black | - 40°C ; + 80°C | - 40°F ; + 176°F |

• Mechanical and climatics - Specific additional elements

| Characteristics | Values | |
|-----------------------|---|------------------|
| Protection index | IP 67 (Splashproof - 1/2 hour under 1 m of water) | |
| Operating temperature | - 40°C ; + 80°C | - 40°F ; + 176°F |

Options



- **Cap: Part-number = JBX BR2 022** : an efficient protection against water

Wiring and assembly instructions

• Panel cutout

The panel cutout is the same as for the JBX size 2 shells except for the HC.

• Operation to add during the plug assembly:

Deposit of watertight thread glue between the backnut (Ⓒ on the drawing p17) and the connection shell (Ⓓ on the drawing p17).
Advised glue = Loctite 542.

• Sealed Panel cutout



Push-Pull connectors



Accessories JAX - JBX

• Insulating washer



| Part number | Shell size | Ø A | B | L | M | N | T | E |
|-------------|------------|-----|------|-----|-----|-----|------|------|
| JBX 00 RIN | 00 | 10 | 8.8 | 1.8 | 1 | 0.8 | 8 | 4.4 |
| JBX 0 RI* | 0 | 12 | 10.8 | 1.8 | 1 | 0.8 | 9.9 | 6.4 |
| JBX 1 RI* | 1 | 16 | 13.8 | 1.8 | 1 | 0.8 | 12.2 | 8.4 |
| JBX 2 RI* | 2 | 21 | 17.8 | 2.2 | 1.2 | 0.8 | 16.2 | 8.2 |
| JBX 3 RI* | 3 | 25 | 21.8 | 2.2 | 1.2 | 0.8 | 20.2 | 10.1 |

* Washer colors as protective boots.
In size 00, available only in black.

Material : PA 6/6

Working temperature : - 40°C ; + 125°C
- 40°F ; + 257°F

Using 2 washers for receptacle / panel insulating

Be careful : usable for the JAX and JBX series but not for sealed connectors (JKX and sealed JBX size 2).

• Grounding washer



| Part number | Shell size | Dimensions | | | |
|---------------|------------|------------|------|-----|------|
| | | Ø A | Ø B | L | N |
| JAX RA 00 251 | 00 | 10 | 7.2 | 0.3 | 21.5 |
| JAX RA 0 251 | 0 | 13 | 9.1 | 0.3 | 24 |
| JAX RA 1 251 | 1 | 16 | 12.2 | 0.3 | 24 |
| JAX RA 2 251 | 2 | 21 | 15.1 | 0.8 | 35 |
| JAX RA 3 251 | 3 | 25 | 18.1 | 0.8 | 37 |

Material : - Brass
- Nickel plated (3 µm)

Be careful : usable for the JAX and JBX series but not for sealed connectors (JKX and sealed JBX size 2).

Push-Pull connectors



Accessories JAX-JBX

• Locking washer



| Part number | Shell size | Dimensions | | | |
|-------------|------------|------------|------|-----|---|
| | | Ø A | Ø B | C | D |
| JAX RE 0 | 0 | 9.2 | 12.5 | 0.6 | 1 |
| JAX RE 1 | 1 | 12.2 | 16 | 0.6 | 1 |
| JBX RE 2 | 2 | 16 | 19.8 | 0.6 | 1 |

Piece parts JBX-JKX

• Crimp contacts (if ordered separately)

| Shell size | Ø contact | Part Number | |
|------------|-----------|----------------|----------------|
| | | Crimp pin | Crimp socket |
| 0 | 0.9 | JBX 0 CT MC 09 | JBX 0 CT FC 09 |
| | 0.7 | JBX 0 CT MC 07 | JBX 0 CT FC 07 |
| 1 | 1.3 | JBX 1 CT MC 13 | JBX 1 CT FC 13 |
| | 0.9 | JBX 1 CT MC 09 | JBX 1 CT FC 09 |
| 2 | 0.7 | JBX 1 CT MC 07 | JBX 1 CT FC 07 |
| | 2 | JBX 2 CT MC 20 | JBX 2 CT FC 20 |
| | 1.6 | JBX 2 CT MC 16 | JBX 2 CT FC 16 |
| | 1.3 | JBX 2 CT MC 13 | JBX 2 CT FC 13 |
| | 0.9 | JBX 2 CT MC 09 | JBX 2 CT FC 09 |
| 3 | 0.7 | JBX 2 CT MC 07 | JBX 2 CT FC 07 |
| | 2 | JBX 3 CT MC 20 | JBX 3 CT FC 20 |
| | 1.6 | JBX 3 CT MC 16 | JBX 3 CT FC 16 |
| | 1.3 | JBX 3 CT MC 13 | JBX 3 CT FC 13 |
| | 0.9 | JBX 3 CT MC 09 | JBX 3 CT FC 09 |
| | 0.7 | JBX 3 CT MC 07 | JBX 3 CT FC 07 |

• Solder contacts (if ordered separately)

| Shell size | Ø contact | Part Number | |
|------------|-----------|----------------|----------------|
| | | Solder pin | Solder socket |
| 0 | 0.9 | JBX 0 CT MS 09 | JBX 0 CT FS 09 |
| 1 | 1.3 | JBX 1 CT MS 13 | JBX 1 CT FS 13 |
| | 0.9 | JBX 1 CT MS 09 | JBX 1 CT FS 09 |
| 2 | 2 | JBX 2 CT MS 20 | JBX 2 CT FS 20 |
| | 1.6 | JBX 2 CT MS 16 | JBX 2 CT FS 16 |
| | 1.3 | JBX 2 CT MS 13 | JBX 2 CT FS 13 |
| | 0.9 | JBX 2 CT MS 09 | JBX 2 CT FS 09 |
| 3 | 2 | JBX 3 CT MS 20 | JBX 3 CT FS 20 |
| | 1.6 | JBX 3 CT MS 16 | JBX 3 CT FS 16 |
| | 1.3 | JBX 3 CT MS 13 | JBX 3 CT FS 13 |
| | 0.9 | JBX 3 CT MS 09 | JBX 3 CT FS 09 |

Solder contacts of 0.5 mm and 0.7 mm diameter not available separately (always fixed into the insulator).

Push-Pull connectors



Piece parts JBX-JKX

- Inserts for removable solder and crimp contacts (if ordered separately)

| Shell size | Insert | Insert Part Number | |
|------------|--------|--------------------|-----------------|
| | | Pin contacts | Socket contacts |
| 0 | 02 | JBX 0 BI 02 MS | JBX 0 BI 02 FS |
| | 03 | JBX 0 BI 03 MS | JBX 0 BI 03 FS |
| | 04 | JBX 0 BI 04 MS | JBX 0 BI 04 FS |
| | 05 | JBX 0 BI 05 MS | JBX 0 BI 05 FS |
| 1 | 02 | JBX 1 BI 02 MS | JBX 1 BI 02 FS |
| | 03 | JBX 1 BI 03 MS | JBX 1 BI 03 FS |
| | 04 | JBX 1 BI 04 MS | JBX 1 BI 04 FS |
| | 05 | JBX 1 BI 05 MS | JBX 1 BI 05 FS |
| | 06 | JBX 1 BI 06 MS | JBX 1 BI 06 FS |
| | 07 | JBX 1 BI 07 MS | JBX 1 BI 07 FS |
| | 08 | JBX 1 BI 08 MS | JBX 1 BI 08 FS |
| 2 | 02 | JBX 2 BI 02 MS | JBX 2 BI 02 FS |
| | 03 | JBX 2 BI 03 MS | JBX 2 BI 03 FS |
| | 04 | JBX 2 BI 04 MS | JBX 2 BI 04 FS |
| | 05 | JBX 2 BI 05 MS | JBX 2 BI 05 FS |
| | 06 | JBX 2 BI 06 MS | JBX 2 BI 06 FS |
| | 07 | JBX 2 BI 07 MS | JBX 2 BI 07 FS |
| | 08 | JBX 2 BI 08 MS | JBX 2 BI 08 FS |
| | 10 | JBX 2 BI 10 MS | JBX 2 BI 10 FS |
| | 12 | JBX 2 BI 12 MS | JBX 2 BI 12 FS |
| | 16 | JBX 2 BI 16 MS | JBX 2 BI 16 FS |
| | 18 | JBX 2 BI 18 MS | JBX 2 BI 18 FS |
| 3 | 03 | JBX 3 BI 03 MS | JBX 3 BI 03 FS |
| | 04 | JBX 3 BI 04 MS | JBX 3 BI 04 FS |
| | 07 | JBX 3 BI 07 MS | JBX 3 BI 07 FS |
| | 10 | JBX 3 BI 10 MS | JBX 3 BI 10 FS |
| | 14 | JBX 3 BI 14 MS | JBX 3 BI 14 FS |
| | 18 | JBX 3 BI 18 MS | JBX 3 BI 18 FS |
| | 22 | JBX 3 BI 22 MS | JBX 3 BI 22 FS |
| | 30 | JBX 3 BI 30 MS | JBX 3 BI 30 FS |



Push-Pull connectors



• Inserts with fixed solder contacts (if ordered separately)

| Shell size | Insert | Insert Part Number | |
|------------|--------|--------------------|------------------|
| | | Pin contacts | Socket contacts |
| 00 | 04 | JBX 00 BI 04 MPS | JBX 00 BI 04 FPS |
| 0 | 04 | JBX 0 BI 04 MSS | JBX 0 BI 04 FSS |
| | 05 | JBX 0 BI 05 MSS | JBX 0 BI 05 FSS |
| | 06 | JBX 0 BI 06 MPS | JBX 0 BI 06 FPS |
| | 07 | JBX 0 BI 07 MPS | JBX 0 BI 07 FPS |
| 1 | 07 | JBX 1 BI 07 MSS | JBX 1 BI 07 FSS |
| | 08 | JBX 1 BI 08 MSS | JBX 1 BI 08 FSS |
| | 10 | JBX 1 BI 10 MPS | JBX 1 BI 10 FPS |
| 2 | 12 | JBX 2 BI 12 MSS | JBX 2 BI 12 FSS |
| | 16 | JBX 2 BI 16 MSS | JBX 2 BI 16 FSS |
| | 18 | JBX 2 BI 18 MSS | JBX 2 BI 18 FSS |
| | 19 | JBX 2 BI 19 MSS | JBX 2 BI 19 FSS |
| 3 | 22 | JBX 3 BI 22 MSS | JBX 3 BI 22 FSS |
| | 30 | JBX 3 BI 30 MSS | JBX 3 BI 30 FSS |



Toolings JBX - JKX

• Manual extraction tools

Contacts automatically extracted

The extraction tool is similar for both male and female contacts.



| Shell size | ∅ Contacts | SOURIAU Part number | ASTRO Part number |
|------------|------------|---------------------|-------------------|
| 0 | 0.7 | JBX OUT DC 07 | ATJP 2045 |
| | 0.9 | JBX OUT DC 09 | ATJP 2057 |
| 1 | 0.7 | JBX OUT DC 07 | ATJP2045 |
| | 0.9 | JBX OUT DC 09 | ATJP 2057 |
| | 1.3 | JBX OUT DC 13 | ATJP 2077 |
| 2 | 0.7 | JBX OUT DC 07 | ATJP 2045 |
| | 0.9 | JBX OUT DC 09 | ATJP 2057 |
| | 1.3 | JBX OUT DC 13 | ATJP 2077 |
| | 1.6 | JBX OUT DC 16 | ATJP 2095 |
| | 2.0 | JBX OUT DC 20 | ATJP 2115 |
| 3 | 0.7 | JBX OUT DC 07 | ATJP 2045 |
| | 0.9 | JBX OUT DC 09 | ATJP 2057 |
| | 1.3 | JBX OUT DC 13 | ATJP 2077 |
| | 1.6 | JBX OUT DC 16 | ATJP 2095 |
| | 2.0 | JBX OUT DC 20 | ATJP 2115 |

The contact is automatically extracted without the need of pulling onto the cable.

Push-Pull connectors



Toolings JBX - JKX

• Crimping tool



Specifications MIL-C-22520 / 7.01

| | MIL P/N - SOURIAU P/N | Supplier P/N |
|-------------------------------------|-----------------------|---------------------------------------|
| Contacts 0.7 mm - 0.9 mm and 1.3 mm | MIL-22520/7-01 | Daniels : MH860 Buchanan : 616 336 |



Specifications MIL-C-22520 / 1.01

| | MIL P/N - SOURIAU P/N | Supplier P/N |
|--------------------------|-----------------------|-------------------------------------|
| Contacts 1.6 mm and 2 mm | MIL-22520/1-01 | Daniels : AF8 Buchanan : 615 708 |

• Locator for pin and socket 0.7 - 0.9 mm and 1.3 mm contacts



| Shell size | Ø contacts | AWG | Male contact | | | Female contact | | |
|------------|------------|--------------|----------------|-------------|-----------|----------------|-------------|-----------|
| | | | SOURIAU P/N | DANIELS P/N | ASTRO P/N | SOURIAU P/N | DANIELS P/N | ASTRO P/N |
| 0 | 0.7 | 22 - 24 - 26 | JBX 0 OUT LP07 | 86 - 223 | / | JBX 0 OUT LS07 | 86 - 224 | / |
| | 0.9 | 20 - 22 - 24 | JBX 0 OUT LP09 | 86 - 225 | / | JBX 0 OUT LS09 | 86 - 226 | / |
| 1 | 0.7 | 22 - 24 - 26 | JBX 1 OUT LP07 | 86 - 196 | 642 - 001 | JBX 1 OUT LS07 | 86 - 197 | 642 - 004 |
| | 0.9 | 20 - 22 - 24 | JBX 1 OUT LP09 | 86 - 198 | 642 - 002 | JBX 1 OUT LS09 | 86 - 199 | 642 - 005 |
| | 1.3 | 18 - 20 - 22 | JBX 1 OUT LP13 | 86 - 200 | 642 - 003 | JBX 1 OUT LS13 | 86 - 201 | 642 - 006 |
| 2 | 0.7 | 22 - 24 - 26 | JBX 2 OUT LP07 | 86 - 202 | 642 - 007 | JBX 2 OUT LS07 | 86 - 203 | 642 - 010 |
| | 0.9 | 20 - 22 - 24 | JBX 2 OUT LP09 | 86 - 204 | 642 - 008 | JBX 2 OUT LS09 | 86 - 205 | 642 - 011 |
| | 1.3 | 18 - 20 - 22 | JBX 2 OUT LP13 | 86 - 206 | 642 - 009 | JBX 2 OUT LS13 | 86 - 207 | 642 - 012 |
| 3 | 0.7 | 22 - 24 - 26 | JBX 3 OUT LP07 | 86 - 217 | 642 - 014 | JBX 3 OUT LS07 | 86 - 214 | 642 - 017 |
| | 0.9 | 20 - 22 - 24 | JBX 3 OUT LP09 | 86 - 218 | 642 - 015 | JBX 3 OUT LS09 | 86 - 215 | 642 - 018 |
| | 1.3 | 18 - 20 - 22 | JBX 3 OUT LP13 | 86 - 219 | 642 - 016 | JBX 3 OUT LS13 | 86 - 216 | 642 - 019 |

• Turret with locator for pin and socket 1.6 mm and 2 mm contacts



| Shell size | Ø contacts | AWG | Male and female contacts | | |
|------------|------------|--------------|--------------------------|-------------|-----------|
| | | | SOURIAU P/N | DANIELS P/N | ASTRO P/N |
| 2 | 1.6 | 14 - 16 - 18 | JBX 2 OUT LT16 | TH 564 | 650 - 030 |
| | 2 | 12 - 14 - 16 | JBX 2 OUT LT20 | TH 565 | 650 - 031 |
| 3 | 1.6 | 14 - 16 - 18 | JBX 3 OUT LT16 | TH 566 | 650 - 038 |
| | 2 | 12 - 14 - 16 | JBX 3 OUT LT20 | TH 567 | 650 - 035 |



Examples of custom designs derivated from standard connectors lines

- **Watertight receptacles**



- **JBX series:**

Custom watertight receptacles designed to customer requirements

- **Black finish plating**



- **JBX and JKX series**, black chrome plating

Applications: Military radiocommunication

Push-Pull connectors



Request form please fill in and fax to SOURIAU - Customer service
(see the address page for your local contact)

Name : Tel number : Fax number :

Title : E-mail :

Company :

Address :

Applications :

- Medical Audio Video Instrumentation Nuclear physics
 GPS Transportation Metrology Other

Detailed description of end product, unit or application

Connector description :

- Series : Shell configuration :
 Shell size : Protective boot : Color :
 Number of contacts :
 Type of contacts : Solder Crimp Printed circuit 90° printed circuit
 Conductor AWG : Coax type : Other :

Electrical :

- Working voltage (AC/DC) : Current rating :
 Impedance (Ohms) : SWR : Frequency
 Contact resistance : Shielding :
 Fibre optics : Multimode Monomode

Environment :

- Temperature : Protection index (IP --) :
 Outside environment :
 Clear Splash proof Sterilization
 Dirt Fluids Radiation
 Chemicals Waterproof Gases
 Salt waterspray

Projections :

- Prototype quantity : Delivery date :
 Preseries quantity : Delivery date :
 Production quantity : Delivery date :
 Production per year : Number of years :
 Target pricing per connector :

Push-Pull connectors



Conversion Table

• Millimeters / Inches

| (mm) | (inches) | (mm) | (inches) | (mm) | (inches) |
|------|----------|------|----------|--------|-----------|
| 0.1 | 0.00394 | 8.2 | 0.32308 | 38.0 | 1.49720 |
| 0.2 | 0.00788 | 8.4 | 0.33096 | 38.5 | 1.51690 |
| 0.3 | 0.01182 | 8.6 | 0.33884 | 39.0 | 1.53660 |
| 0.4 | 0.01576 | 8.8 | 0.34672 | 39.5 | 1.55630 |
| 0.5 | 0.01970 | 9.0 | 0.35460 | 40.0 | 1.57600 |
| 0.6 | 0.02364 | 9.2 | 0.36248 | 40.5 | 1.59570 |
| 0.7 | 0.02758 | 9.4 | 0.37036 | 41.0 | 1.61540 |
| 0.8 | 0.03152 | 9.6 | 0.37824 | 41.5 | 1.63510 |
| 0.9 | 0.03546 | 9.8 | 0.38612 | 42.0 | 1.65480 |
| 1.0 | 0.03940 | 10.0 | 0.39400 | 42.5 | 1.67450 |
| 1.1 | 0.04334 | 10.5 | 0.41370 | 43.0 | 1.69420 |
| 1.2 | 0.04728 | 11.0 | 0.43340 | 43.5 | 1.71390 |
| 1.3 | 0.05122 | 11.5 | 0.45310 | 44.0 | 1.73360 |
| 1.4 | 0.05516 | 12.0 | 0.47280 | 44.5 | 1.75330 |
| 1.5 | 0.05910 | 12.5 | 0.49250 | 45.0 | 1.77300 |
| 1.6 | 0.06304 | 13.0 | 0.51220 | 45.5 | 1.79270 |
| 1.7 | 0.06698 | 13.5 | 0.53190 | 46.0 | 1.81240 |
| 1.8 | 0.07092 | 14.0 | 0.55160 | 46.5 | 1.83210 |
| 1.9 | 0.07486 | 14.5 | 0.57130 | 47.0 | 1.85180 |
| 2.0 | 0.07880 | 15.0 | 0.59100 | 47.5 | 1.87150 |
| 2.1 | 0.08274 | 15.5 | 0.61070 | 48.0 | 1.89120 |
| 2.2 | 0.08668 | 16.0 | 0.63040 | 48.5 | 1.91090 |
| 2.3 | 0.09062 | 16.5 | 0.65010 | 49.0 | 1.93060 |
| 2.4 | 0.09456 | 17.0 | 0.66980 | 49.5 | 1.95030 |
| 2.5 | 0.09850 | 17.5 | 0.68950 | 50.0 | 1.97000 |
| 2.6 | 0.10244 | 18.0 | 0.70920 | 51.0 | 2.00940 |
| 2.7 | 0.10638 | 18.5 | 0.72890 | 52.0 | 2.04880 |
| 2.8 | 0.11032 | 19.0 | 0.74860 | 53.0 | 2.08820 |
| 2.9 | 0.11426 | 19.5 | 0.76830 | 54.0 | 2.12760 |
| 3.0 | 0.11820 | 20.0 | 0.78800 | 55.0 | 2.16700 |
| 3.1 | 0.12214 | 20.5 | 0.80770 | 56.0 | 2.20640 |
| 3.2 | 0.12608 | 21.0 | 0.82740 | 57.0 | 2.24580 |
| 3.3 | 0.13002 | 21.5 | 0.84710 | 58.0 | 2.28520 |
| 3.4 | 0.13396 | 22.0 | 0.86680 | 59.0 | 2.32460 |
| 3.5 | 0.13790 | 22.5 | 0.88650 | 60.0 | 2.36400 |
| 3.6 | 0.14184 | 23.0 | 0.90620 | 61.0 | 2.40340 |
| 3.7 | 0.14578 | 23.5 | 0.92590 | 62.0 | 2.44280 |
| 3.8 | 0.14972 | 24.0 | 0.94560 | 63.0 | 2.48220 |
| 3.9 | 0.15366 | 24.5 | 0.96530 | 64.0 | 2.52160 |
| 4.0 | 0.15760 | 25.0 | 0.98500 | 65.0 | 2.56100 |
| 4.1 | 0.16154 | 25.5 | 1.00470 | 66.0 | 2.60040 |
| 4.2 | 0.16548 | 26.0 | 1.02440 | 67.0 | 2.63980 |
| 4.3 | 0.16942 | 26.5 | 1.04410 | 68.0 | 2.67920 |
| 4.4 | 0.17336 | 27.0 | 1.06380 | 69.0 | 2.71860 |
| 4.5 | 0.17730 | 27.5 | 1.08350 | 70.0 | 2.75800 |
| 4.6 | 0.18124 | 28.0 | 1.10320 | 71.0 | 2.79740 |
| 4.7 | 0.18518 | 28.5 | 1.12290 | 72.0 | 2.83680 |
| 4.8 | 0.18912 | 29.0 | 1.14260 | 73.0 | 2.87620 |
| 4.9 | 0.19306 | 29.5 | 1.16230 | 74.0 | 2.91560 |
| 5.0 | 0.19700 | 30.0 | 1.18200 | 75.0 | 2.95500 |
| 5.2 | 0.20488 | 30.5 | 1.20170 | 80.0 | 3.15200 |
| 5.4 | 0.21276 | 31.0 | 1.22140 | 85.0 | 3.34900 |
| 5.6 | 0.22064 | 31.5 | 1.24110 | 90.0 | 3.54600 |
| 5.8 | 0.22852 | 32.0 | 1.26080 | 100.0 | 3.94000 |
| 6.0 | 0.23640 | 32.5 | 1.28050 | 200.0 | 7.88000 |
| 6.2 | 0.24428 | 33.0 | 1.30020 | 400.0 | 15.76000 |
| 6.4 | 0.25216 | 33.5 | 1.31990 | 600.0 | 23.64000 |
| 6.6 | 0.26004 | 34.0 | 1.33960 | 800.0 | 31.52000 |
| 6.8 | 0.26792 | 34.5 | 1.35930 | 1000.0 | 39.40000 |
| 7.0 | 0.27580 | 35.0 | 1.37900 | 1200.0 | 47.28000 |
| 7.2 | 0.28368 | 35.5 | 1.39870 | 1600.0 | 63.04000 |
| 7.4 | 0.29156 | 36.0 | 1.41840 | 2000.0 | 78.80000 |
| 7.6 | 0.29944 | 36.5 | 1.43810 | 3200.0 | 126.08000 |
| 7.8 | 0.30732 | 37.0 | 1.45780 | | |
| 8.0 | 0.31520 | 37.5 | 1.47750 | | |

• °C/°F

| (°C) | (°F) |
|------|------|
| - 70 | - 94 |
| - 65 | - 85 |
| - 55 | - 67 |
| - 50 | - 58 |
| - 40 | - 40 |
| 0 | 32 |
| 37 | 98.6 |
| 80 | 176 |
| 125 | 257 |
| 150 | 302 |
| 170 | 338 |
| 200 | 392 |
| 250 | 482 |

• Pressure conversion

| bar | psi | mmHg (torr) |
|-----|-------|-------------|
| 10 | 145.0 | 7600 |
| 5 | 72.5 | 3800 |
| 2 | 29.0 | 1520 |
| 1 | 14.5 | 760 |
| 0.5 | 7.2 | 380 |
| 0.1 | 1.4 | 76 |

| mbar | psi | torr (mmHg) |
|------|-------|-------------|
| 100 | 1.4 | 76 |
| 50 | 0.72 | 38 |
| 10 | 0.14 | 7.6 |
| 1.32 | 0.019 | 1 |

Компания «Океан Электроники» предлагает заключение долгосрочных отношений при поставках импортных электронных компонентов на взаимовыгодных условиях!

Наши преимущества:

- Поставка оригинальных импортных электронных компонентов напрямую с производств Америки, Европы и Азии, а так же с крупнейших складов мира;
- Широкая линейка поставок активных и пассивных импортных электронных компонентов (более 30 млн. наименований);
- Поставка сложных, дефицитных, либо снятых с производства позиций;
- Оперативные сроки поставки под заказ (от 5 рабочих дней);
- Экспресс доставка в любую точку России;
- Помощь Конструкторского Отдела и консультации квалифицированных инженеров;
- Техническая поддержка проекта, помощь в подборе аналогов, поставка прототипов;
- Поставка электронных компонентов под контролем ВП;
- Система менеджмента качества сертифицирована по Международному стандарту ISO 9001;
- При необходимости вся продукция военного и аэрокосмического назначения проходит испытания и сертификацию в лаборатории (по согласованию с заказчиком);
- Поставка специализированных компонентов военного и аэрокосмического уровня качества (Xilinx, Altera, Analog Devices, Intersil, Interpoint, Microsemi, Actel, Aeroflex, Peregrine, VPT, Syfer, Eurofarad, Texas Instruments, MS Kennedy, Miteq, Cobham, E2V, MA-COM, Hittite, Mini-Circuits, General Dynamics и др.);

Компания «Океан Электроники» является официальным дистрибьютором и эксклюзивным представителем в России одного из крупнейших производителей разъемов военного и аэрокосмического назначения «JONHON», а так же официальным дистрибьютором и эксклюзивным представителем в России производителя высокотехнологичных и надежных решений для передачи СВЧ сигналов «FORSTAR».



JONHON

«JONHON» (основан в 1970 г.)

Разъемы специального, военного и аэрокосмического назначения:

(Применяются в военной, авиационной, аэрокосмической, морской, железнодорожной, горно- и нефтедобывающей отраслях промышленности)

«FORSTAR» (основан в 1998 г.)

ВЧ соединители, коаксиальные кабели,
кабельные сборки и микроволновые компоненты:

(Применяются в телекоммуникациях гражданского и специального назначения, в средствах связи, РЛС, а так же военной, авиационной и аэрокосмической отраслях промышленности).



Телефон: 8 (812) 309-75-97 (многоканальный)

Факс: 8 (812) 320-03-32

Электронная почта: ocean@oceanchips.ru

Web: <http://oceanchips.ru/>

Адрес: 198099, г. Санкт-Петербург, ул. Калинина, д. 2, корп. 4, лит. А