



The Future of Analog IC Technology®

MP3115 High-Efficiency, Single-Cell Alkaline, 1.3MHz Synchronous Step-up Converter with Output Disconnect

DESCRIPTION

The MP3115 is a synchronous, fixed frequency, current mode step-up converter with output-to-input disconnect optimized to boost a single AA Alkaline battery to 2.5V or 3.3V.

It can startup from an input voltage as low as 0.950V and provide in-rush current limiting as well as output short circuit protection. The integrated P-Channel synchronous rectified switch provides improved efficiency and eliminates an external schottky diode. The output disconnect feature allows the output to be completely discharged, thus allowing the part to draw less than 1µA of current in shutdown mode.

The 1.3MHz switching frequency allows for the use of smaller external components and the internal compensation and soft-start minimize the external component count, all helping to produce a compact solution for a wide range of load current.

The MP3115 regulates the output voltage up to 4.0V or 3.3V at 200mA from a single cell AA battery, without the use of an external Schottky diode.

The MP3115 is offered in a SOT23-6 package.

EVALUATION BOARD REFERENCE

Board Number	Dimensions
EV3115DT-00A	L x W x H (5cm x 5cm x 1.2cm)

FEATURES

- Over 90% Efficiency
- Output-to-Input Disconnect in Shutdown Mode
- Internal Synchronous Rectifier
- Output Voltage up to 4.0V without an External Schottky Diode
- Inrush Current Limiting and Internal Soft-Start
- Internal Compensation
- 1A Minimum Peak Current Limit
- 1.3MHz Fixed Switching Frequency
- Zero Current Shutdown Mode
- Thermal Shutdown
- 6-Pin SOT-23 Package

APPLICATIONS

- Single-cell Alkaline Consumer Products
- MP3 Players
- Wireless Mouse
- RFTags
- Audio Recorders

MPS and "The Future of Analog IC Technology" are Registered Trademarks of Monolithic Power Systems, Inc.

TYPICAL APPLICATION

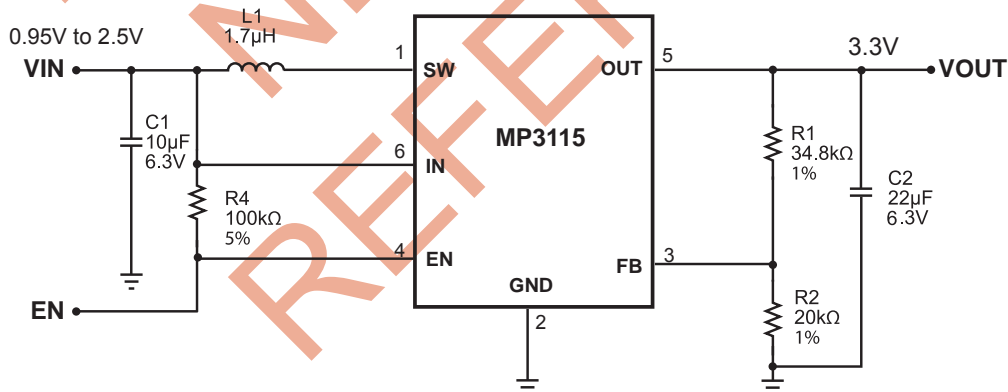

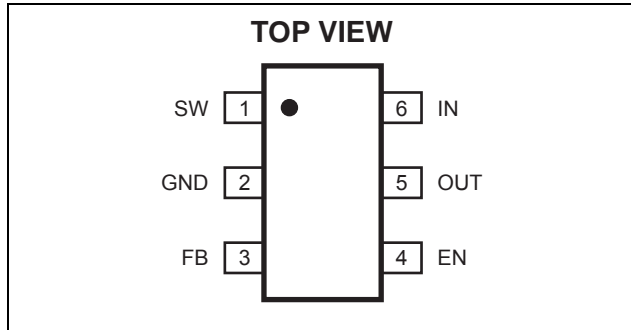
PACKAGE REFERENCE

Part Number*	Package	Temperature
MP3115DT	SOT23-6	-40°C to +85°C

* For Tape & Reel, add suffix -Z (eg. MP3115DT-Z)
For RoHS Compliant Packaging, add suffix -LF
(eg. MP3115DT-LF-Z)

ABSOLUTE MAXIMUM RATINGS ⁽¹⁾

Supply Voltage V_{IN} 2.5V
 V_{SW} -0.3V to 6.5V
 All Other Pins..... -0.3V to 6.5V
 Storage Temperature -65°C to +150°C

Thermal Resistance ⁽³⁾ θ_{JA} θ_{JC}
 SOT23-6 195..... 110.. °C/W

Notes:

- 1) Exceeding these ratings may damage the device.
- 2) The device is not guaranteed to function outside of its operating conditions.
- 3) Measured on approximately 1" square of 1 oz copper.

ELECTRICAL CHARACTERISTICS

$V_{IN} = 1.5V$, $V_{EN} = V_{OUT} = 3.3V$, $T_A = +25^\circ C$, unless otherwise noted.

Parameter	Symbol	Condition	Min	Typ	Max	Units
Minimum Startup Voltage	V_{ST}	$R_L = 3k\Omega$, Rising Edge		0.95	1.1	V
Minimum Operating Voltage ⁽⁴⁾	V_{IN}	$V_{EN} = V_{IN}$			0.5	V
Output Voltage Range	V_{OUT}		2.5		4.0	V
Supply Current (Shutdown)		$V_{EN} = V_{OUT} = 0V$		0	1	μA
Supply Current (Quiescent)		$V_{FB} = 1.3V$		200		μA
Feedback Voltage	V_{FB}			1.225		V
Feedback Input Current		$V_{FB} = 1.2V$		10		nA
Switching Frequency	f_{SW}	$V_{FB} = 1.1V$		1.3		MHz
Maximum Duty Cycle	D_{MAX}	$V_{FB} = 1.1V$	85	90		%
EN Input Low Voltage					0.4	V
EN Input High Voltage			0.9			V
EN Input Current		$V_{EN} = 3V$		0	1	μA
NMOS On Resistance	R_{NMOS}			300		m Ω
NMOS Leakage Current		$V_{SW} = 5.5V$		1		μA
NMOS Current Limit	I_{LIM}		1	1.3		A
PMOS On Resistance	R_{PMOS}			600		m Ω
PMOS Leakage Current		$V_{EN} = V_{OUT} = 0V$, $V_{SW} = 3V$		1		μA
Thermal Shutdown ⁽⁵⁾				160		°C
Thermal Shutdown Hysteresis ⁽⁵⁾				30		°C
Minimum On Time ⁽⁵⁾				100	150	ns

Notes:

- 4) The MP3115 is not dependent on V_{IN} when V_{OUT} is greater than 2.4V.
- 5) Guaranteed by design, not tested.

PIN FUNCTIONS

Pin #	Name	Description
1	SW	Output Switch Node. SW is the drain of the internal N-Channel and P-Channel MOSFETs. Connect the inductor to SW to complete the step-up converter.
2	GND	Ground.
3	FB	Regulation Feedback Input. Connect an external resistive voltage divider from the output to FB to set the output voltage.
4	EN	Regulator On/Off Control Input. A logic high input ($V_{EN} > 0.9V$) turns on the regulator. A logic low input ($V_{EN} < 0.4V$) puts the MP3115 into low current shutdown mode.
5	OUT	Supply Input for the MP3115 and Output Voltage Sense Input. Connect to the output of the converter.
6	IN	Input Voltage.

TYPICAL PERFORMANCE CHARACTERISTICS

C1 = 10µF, C2=22µF, L=1.7µH,R2=20K, TA = +25°C, unless otherwise noted.

Efficiency vs. Load Current

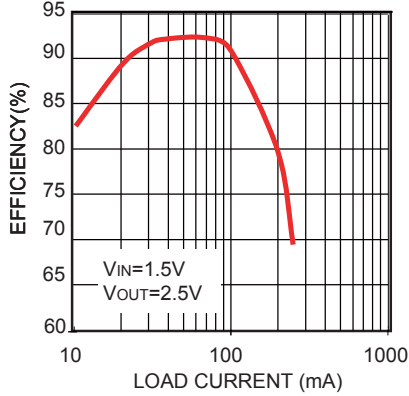

Efficiency vs. Load Current

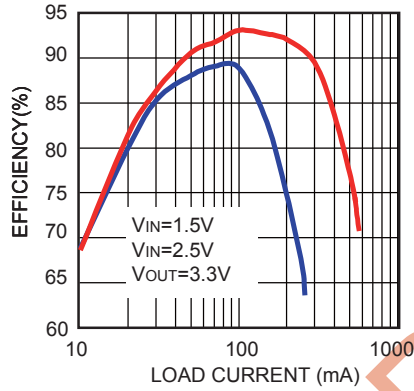

Load Regulation

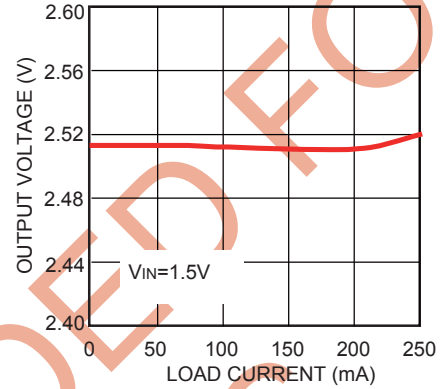

Line Regulation

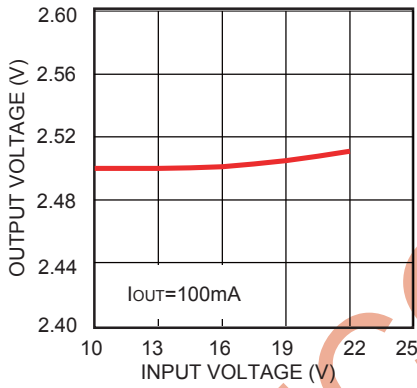

Minimum Start VIN vs. Iout

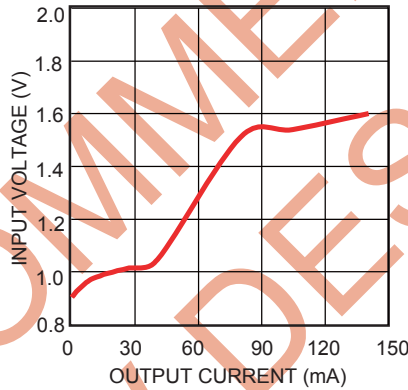

IPEAK vs. Duty Cycle

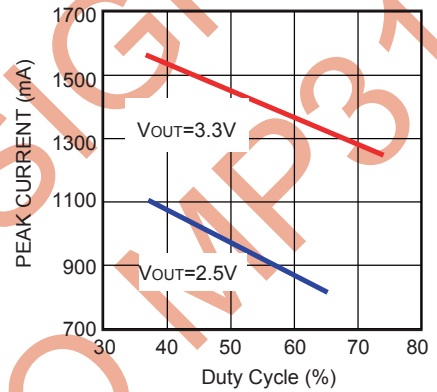

Line Transient

VIN=1.2V to 2V, VOUT=2.5V, IOUT=48mA
VEN=VIN, Resistor Load

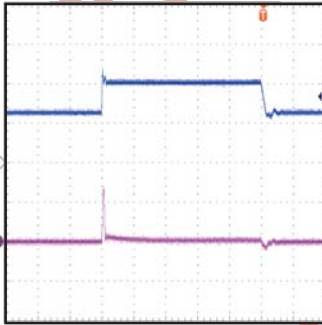

200µs/div.

Load Transient

VIN=1.2V, VOUT=2.5V, IOUT=0mA to 50mA
VEN=VIN, Resistor Load

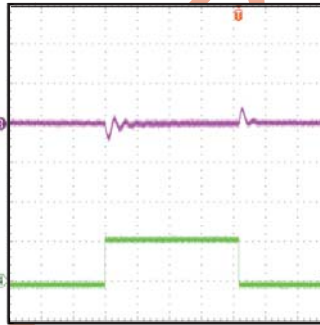

40µs/div.

Inrush Current

VEN=2V, VIN=1.5V, VOUT=3.3V
IOUT=41mA, CFF=10nF

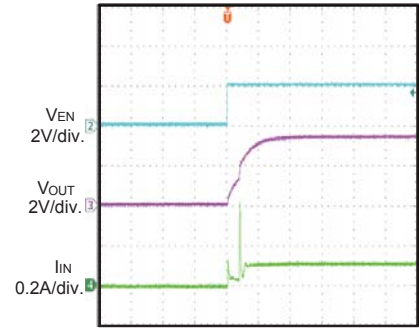

1ms/div.

TYPICAL PERFORMANCE CHARACTERISTICS (continued)
C1 = 10 μ F, C2=22 μ F, L=1.7 μ H, R2=20K, T_A = +25°C, unless otherwise noted.
Enable Turn On vs. Outputs

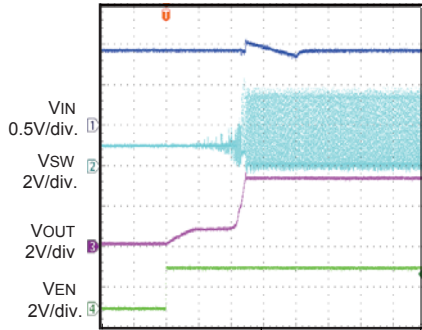
 VIN=0.93V, VOUT=3.3V
 VEN=2V, Load with 3k Ω Resistor

1ms/div

Enable Turn Off vs. Outputs

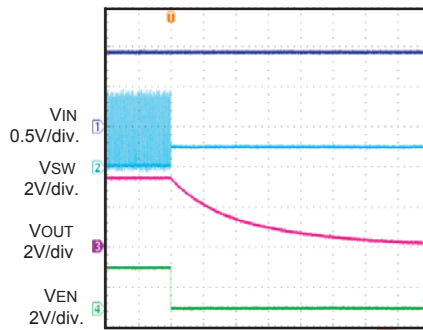
 VIN=0.93V, VOUT=3.3V
 VEN=2V, Load with 3k Ω Resistor

10ms/div

VIN Rump Up

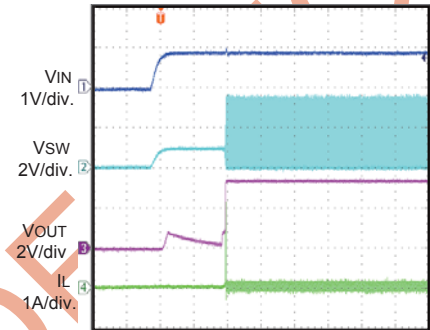
 VIN=VEN=0.93V, VOUT=3.3V
 Load with 3k Ω Resistor

20ms/div.

Short Circuit

VIN=VEN=2V, VOUT=3.3V

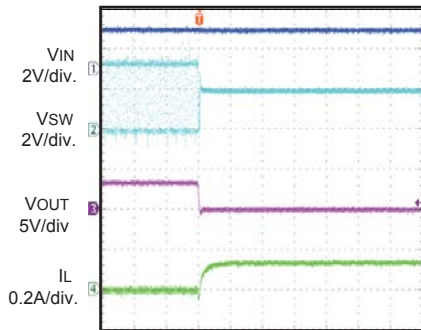

 20 μ s/div

Short Circuit Recovery

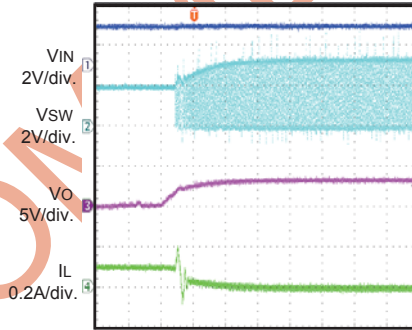
VIN=VEN=2V, VOUT=3.3V

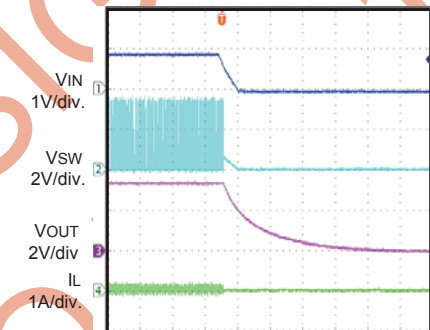

 200 μ s/div

VIN Rump Down

 VIN=VEN=0.93V, VOUT=3.3V
 Load with 3k Ω Resistor

20ms/div.

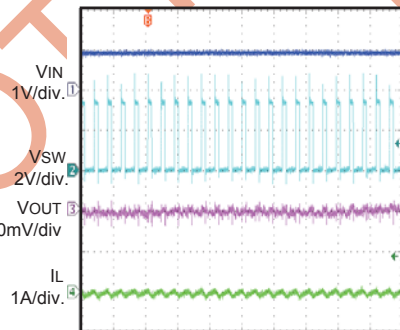
No Load Ripple

 VIN=VEN=0.92V, VOUT=3.3V
 IOUT=0mA

 2 μ s/div

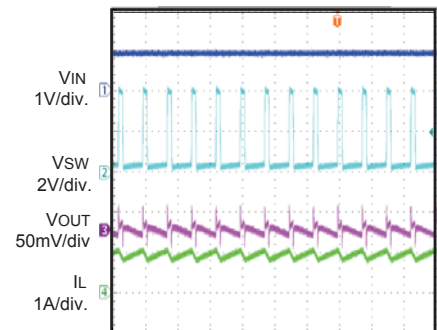
Full Load Ripple

 VIN=VEN=0.95V, VOUT=3.3V
 IOUT=150mA

 1 μ s/div

OPERATION

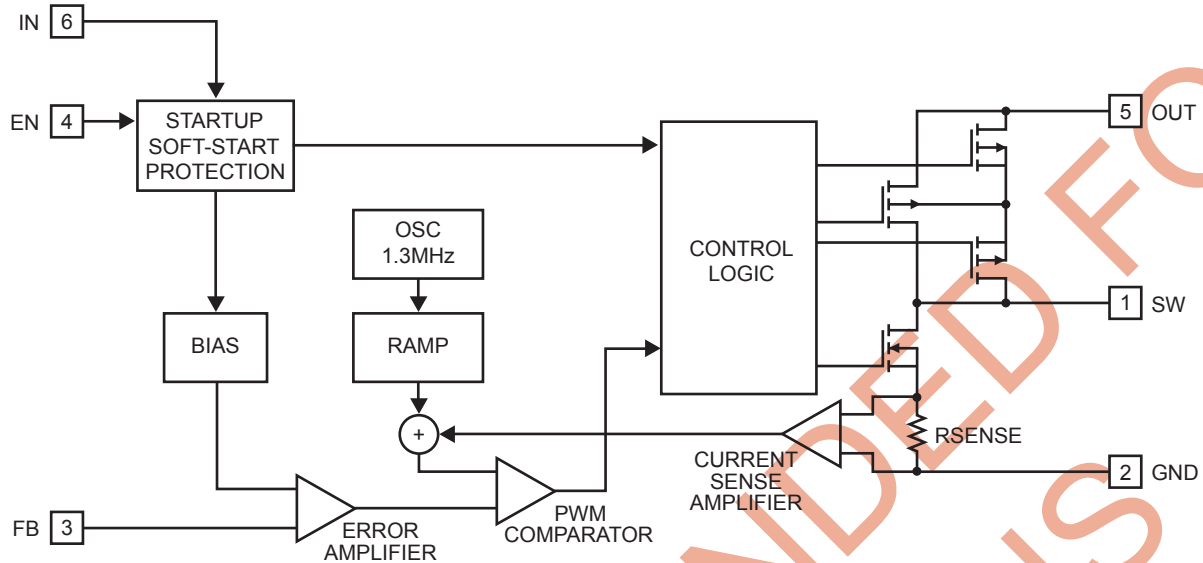

Figure 1—Functional Block Diagram

The MP3115 uses a 1.3MHz fixed-frequency, current-mode regulation architecture to regulate the output voltage. The MP3115 measures the output voltage through an external resistive voltage divider and compares that to the internal 1.2V reference to generate the error voltage. The current-mode regulator compares the error voltage to the inductor current to regulate the output voltage. The use of current-mode regulation improves transient response and control loop stability.

When the MP3115 is disabled ($EN < 0.4V$), both power switches are off. The body of the P-Channel MOSFET connects to SW thus there is no current path from SW to OUT. When the MP3115 is enabled ($EN > 0.8V$), the P-Channel MOSFET turns on to charge the output capacitor to a voltage close to the input voltage. During this time, the gate of the P-Channel is controlled to limit the chip power dissipation. The MP3115 starts switching when the output voltage is close to the input voltage. If the input voltage is less than 1.6V, the MP3115 will start with CCM (constant current mode) until the output voltage crosses 1.6V. After that, the soft-start circuit will take over to bring the output voltage to the regulated value.

At the beginning of each cycle, the N-channel MOSFET switch is turned on, forcing the inductor current to rise. The current at the source of the switch is internally measured and converted to a voltage by the current sense amplifier. That voltage is compared to the error voltage. When the inductor current rises sufficiently, the PWM comparator turns off the switch, forcing the inductor current to the output capacitor through the internal P-Channel MOSFET rectifier, which forces the inductor current to decrease. The peak inductor current is controlled by the error voltage, which in turn is controlled by the output voltage. Thus the output voltage controls the inductor current to satisfy the load.

The MP3115 has a temperature sensing circuit to protect the part. The MP3115 turns off both switches when the chip temperature reaches 150°C.

APPLICATION INFORMATION

COMPONENT SELECTION

Setting the Output Voltage

Set the output voltage by selecting the resistive voltage divider ratio. The voltage divider drops the output voltage to the 1.2V feedback voltage. Use 20kΩ for the low-side resistor (R2) of the voltage divider. Determine the high-side resistor (R1) by the equation:

$$R1 = \frac{V_{OUT} - V_{FB}}{\left(\frac{V_{FB}}{R2}\right)}$$

Where V_{OUT} is the output voltage, V_{FB} is the 1.2V feedback voltage and $R2=20k\Omega$.

Selecting the Input Capacitor

An input capacitor is required to supply the AC ripple current to the inductor while limiting noise at the input source. Multi-layer ceramic capacitors are recommended as they have extremely low ESR and are available in small footprints. Use an input capacitor of 4.7μF or greater, and place it physically close to the device.

Selecting the Output Capacitor

A single 4.7μF to 10μF ceramic capacitor normally provides sufficient output capacitance for most applications. Larger values (up to 22μF) may be used to obtain extremely low output voltage ripple and improve transient response. The impedance of the ceramic capacitor at the switching frequency is dominated by its capacitance, so the output voltage ripple is mostly independent of ESR. The output voltage ripple V_{RIPPLE} is calculated as:

$$V_{RIPPLE} = \frac{I_{LOAD}(V_{OUT} - V_{IN})}{V_{OUT} \times C2 \times f_{SW}}$$

Where V_{IN} is the input voltage, I_{LOAD} is the load current, $C2$ is the capacitance of the output capacitor and f_{SW} is the 1.3MHz switching frequency.

Selecting the Inductor

The inductor is required to force the output voltage higher while being driven by the lower input voltage. A good rule for determining the inductance is to allow the peak-to-peak ripple current to be approximately 30%-50% of the maximum input current. Make sure that the peak inductor current is below the minimum current limit at the duty cycle used to prevent loss of regulation due to current limit variation.

Calculate the required inductance value L using the equations:

$$L = \frac{V_{IN}(V_{OUT} - V_{IN})}{V_{OUT} \times f_{SW} \times \Delta I}$$

$$I_{IN(MAX)} = \frac{V_{OUT} \times I_{LOAD(MAX)}}{V_{IN} \times \eta}$$

$$\Delta I = (30\% - 50\%) I_{IN(MAX)}$$

Where $I_{LOAD(MAX)}$ is the maximum load current, ΔI is the peak-to-peak inductor ripple current and η is the efficiency. For the MP3115, 4.7μH is recommended for most applications. Choose an inductor that does not saturate at the peak switch current as calculated above with additional margin to cover for heavy load transients and extreme startup conditions.

Selecting the Feed-Forward Capacitor

A feed-forward capacitor in parallel with the high-side resistor R1 can be added to improve the output ripple at both discontinuous conduction modes and the load transient response. A 47pF capacitor is recommended for most applications.

LAYOUT CONSIDERATIONS

High frequency switching regulators require very careful layout for stable operation and low noise. All components must be placed as close to the IC as possible. All feedback components must be kept close to the FB pin to prevent noise injection on the FB pin trace. The ground return of C1 and C2 should be tied close to the GND pin. See the MP3115 demo board layout for reference.

PACKAGE INFORMATION

SOT23-6

PACKAGE OUTLINE DRAWING FOR 6-SOT23 MF-PO-D-0032 revision 2.1

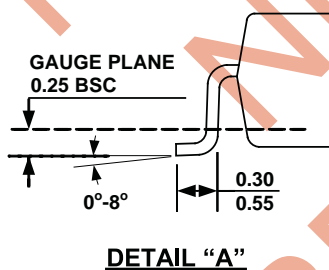
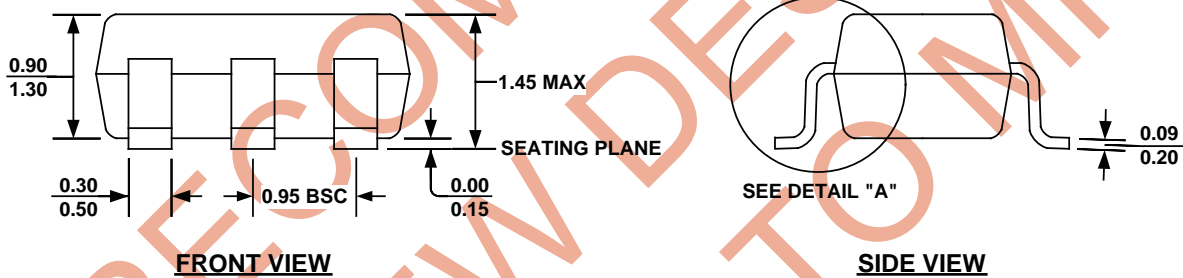
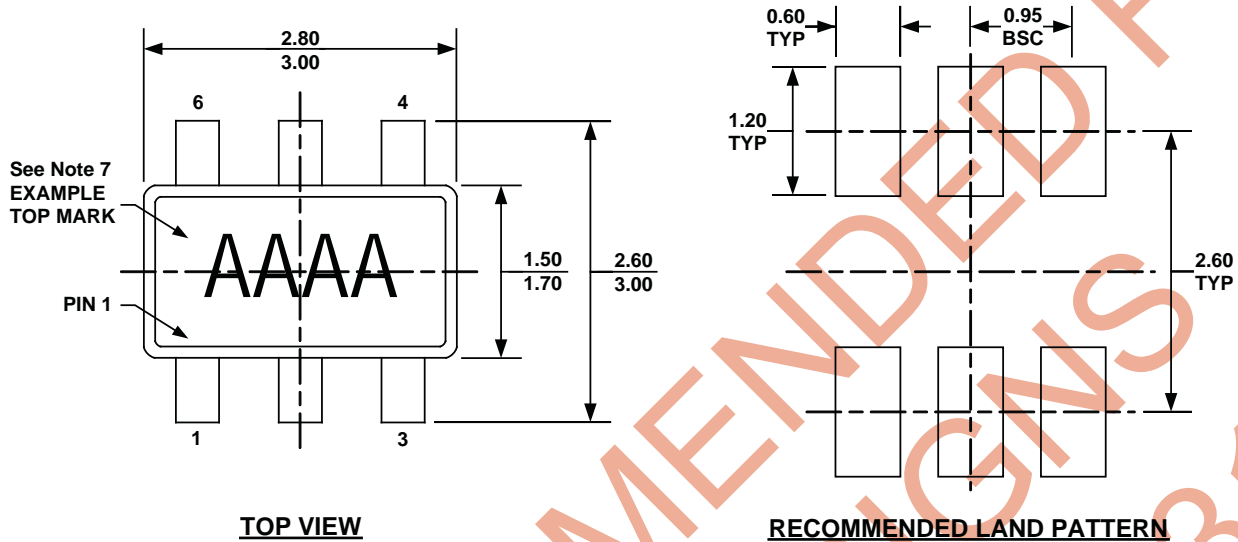

NOTE:

- 1) ALL DIMENSIONS ARE IN MILLIMETERS.
- 2) PACKAGE LENGTH DOES NOT INCLUDE MOLD FLASH, PROTRUSION OR GATE BURR.
- 3) PACKAGE WIDTH DOES NOT INCLUDE INTERLEAD FLASH OR PROTRUSION.
- 4) LEAD COPLANARITY (BOTTOM OF LEADS AFTER FORMING) SHALL BE 0.10 MILLIMETERS MAX.
- 5) DRAWING CONFORMS TO JEDEC MO-178, VARIATION AB.
- 6) DRAWING IS NOT TO SCALE.
- 7) PIN 1 IS LOWER LEFT PIN WHEN READING TOP MARK FROM LEFT TO RIGHT, (SEE EXAMPLE TOP MARK)

NOTICE: The information in this document is subject to change without notice. Users should warrant and guarantee that third party Intellectual Property rights are not infringed upon when integrating MPS products into any application. MPS will not assume any legal responsibility for any said applications.

Компания «Океан Электроники» предлагает заключение долгосрочных отношений при поставках импортных электронных компонентов на взаимовыгодных условиях!

Наши преимущества:

- Поставка оригинальных импортных электронных компонентов напрямую с производств Америки, Европы и Азии, а так же с крупнейших складов мира;
- Широкая линейка поставок активных и пассивных импортных электронных компонентов (более 30 млн. наименований);
- Поставка сложных, дефицитных, либо снятых с производства позиций;
- Оперативные сроки поставки под заказ (от 5 рабочих дней);
- Экспресс доставка в любую точку России;
- Помощь Конструкторского Отдела и консультации квалифицированных инженеров;
- Техническая поддержка проекта, помощь в подборе аналогов, поставка прототипов;
- Поставка электронных компонентов под контролем ВП;
- Система менеджмента качества сертифицирована по Международному стандарту ISO 9001;
- При необходимости вся продукция военного и аэрокосмического назначения проходит испытания и сертификацию в лаборатории (по согласованию с заказчиком);
- Поставка специализированных компонентов военного и аэрокосмического уровня качества (Xilinx, Altera, Analog Devices, Intersil, Interpoint, Microsemi, Actel, Aeroflex, Peregrine, VPT, Syfer, Eurofarad, Texas Instruments, MS Kennedy, Miteq, Cobham, E2V, MA-COM, Hittite, Mini-Circuits, General Dynamics и др.);

Компания «Океан Электроники» является официальным дистрибьютором и эксклюзивным представителем в России одного из крупнейших производителей разъемов военного и аэрокосмического назначения «JONHON», а так же официальным дистрибьютором и эксклюзивным представителем в России производителя высокотехнологичных и надежных решений для передачи СВЧ сигналов «FORSTAR».



JONHON

«JONHON» (основан в 1970 г.)

Разъемы специального, военного и аэрокосмического назначения:

(Применяются в военной, авиационной, аэрокосмической, морской, железнодорожной, горно- и нефтедобывающей отраслях промышленности)

«FORSTAR» (основан в 1998 г.)

ВЧ соединители, коаксиальные кабели,
кабельные сборки и микроволновые компоненты:

(Применяются в телекоммуникациях гражданского и специального назначения, в средствах связи, РЛС, а так же военной, авиационной и аэрокосмической отраслях промышленности).



Телефон: 8 (812) 309-75-97 (многоканальный)

Факс: 8 (812) 320-03-32

Электронная почта: ocean@oceanchips.ru

Web: <http://oceanchips.ru/>

Адрес: 198099, г. Санкт-Петербург, ул. Калинина, д. 2, корп. 4, лит. А