



# Aluminum electrolytic capacitors

Snap-in capacitors

**Series/Type:** B43643

**Date:** December 2019

## Long-life grade capacitors

### Applications

- Power supplies
- Frequency converters
- Uninterruptible power supplies
- Medical appliances
- Solar inverters
- Not for automotive applications unless otherwise specified



### Features

- Extremely high CV product, ultra compact
- High reliability
- High ripple current capability
- Capacitors pass the needle flame test according to IEC 60695-11-5 for all flame exposure times up to 120 s
- RoHS-compatible

### Construction

- Charge/discharge-proof, polar
- Aluminum case, insulated with PET sleeve without insulation sheet at the can bottom
- Snap-in solder pins to hold component in place on PC-board
- Minus pole marking on case surface
- Minus pole not insulated from case
- Overload protection by safety vent on the base

### Terminals

- Standard version with 2 terminals,  
2 lengths available: 6.3 and 4.5 mm
- 3 terminals to ensure correct insertion: length 4.5 mm

**Specifications and characteristics in brief**

Rated voltage $V_R$	200 ... 450 V DC										
Surge voltage $V_S$	$1.15 \cdot V_R$ (for $V_R \leq 250$ V DC) $1.10 \cdot V_R$ (for $V_R \geq 400$ V DC)										
Rated capacitance $C_R$	100 ... 3300 $\mu$ F										
Capacitance tolerance	$\pm 20\%$ $\triangleq$ M										
Dissipation factor $\tan \delta$ (20 °C, 120 Hz)	$V_R \leq 250$ V DC: $\tan \delta \leq 0.15$ $V_R \geq 400$ V DC: $\tan \delta \leq 0.20$										
Leakage current $I_{leak}$ (5 min, 20 °C)	$I_{leak} \leq 0.3 \mu A \cdot \left( \frac{C_R}{\mu F} \cdot \frac{V_R}{V} \right)^{0.7} + 4 \mu A$										
Self-inductance ESL	Approx. 20 nH										
Useful life <sup>1)</sup> 105 °C; $V_R$ ; $I_{AC,R}$	> 3000 h	Requirements: $ \Delta C/C  \leq 20\%$ of initial value $\tan \delta \leq 2$ times initial specified limit $I_{leak} \leq$ initial specified limit									
Voltage endurance test 105 °C; $V_R$	2000 h	Post test requirements: $ \Delta C/C  \leq 10\%$ of initial value $\tan \delta \leq 1.3$ times initial specified limit $I_{leak} \leq$ initial specified limit									
Vibration resistance test	To IEC 60068-2-6, test Fc: Frequency range 10 Hz ... 55 Hz, displacement amplitude 0.35 mm, acceleration max. 5 g, duration 3 $\times$ 2 h. Capacitor mounted by its body which is rigidly clamped to the work surface.										
Characteristics at low temperature	Max. impedance ratio at 100 Hz <table border="1" style="margin-left: 20px;"> <tr> <td><math>V_R</math></td> <td><math>\leq 250</math></td> <td><math>\geq 400</math></td> </tr> <tr> <td><math>Z_{-25^\circ C} / Z_{20^\circ C}</math></td> <td>3</td> <td>5</td> </tr> <tr> <td><math>Z_{-40^\circ C} / Z_{20^\circ C}</math></td> <td>7</td> <td>14</td> </tr> </table>	$V_R$	$\leq 250$	$\geq 400$	$Z_{-25^\circ C} / Z_{20^\circ C}$	3	5	$Z_{-40^\circ C} / Z_{20^\circ C}$	7	14	
$V_R$	$\leq 250$	$\geq 400$									
$Z_{-25^\circ C} / Z_{20^\circ C}$	3	5									
$Z_{-40^\circ C} / Z_{20^\circ C}$	7	14									
IEC climatic category	To IEC 60068-1: $V_R \leq 250$ V DC: 40/105/56 (–40 °C/+105 °C/56 days damp heat test) $V_R \geq 400$ V DC: 25/105/56 (–25 °C/+105 °C/56 days damp heat test) The capacitors can be operated in the temperature range of –40 °C to +105 °C but the impedance at –40 °C must be taken into consideration.										
Sectional specification	IEC 60384-4										

1) Refer to chapter "General technical information, 5 Useful life" on how to interpret useful life.



B43643

Ultra compact – 105 °C

## Dimensional drawings

### Snap-in capacitors with PET insulation sleeve

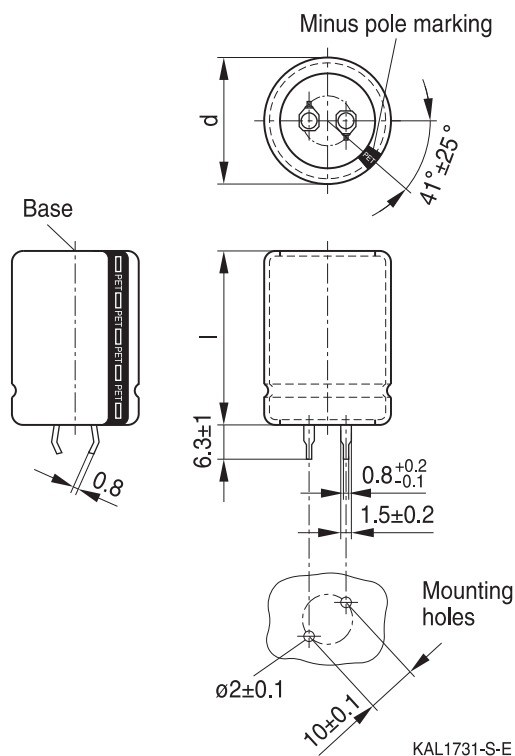

Snap-in terminals, length (6.3 ±1) mm.  
 Also available in a shorter version with a length of (4.5 – 1) mm.  
 Insulation is marked with "PET" on the sleeve.  
 Safety vent on the base.

Dimensions (mm)		Approx. weight (g)	Packing units (pcs.)
d +1	l ±2		
22	25	9	160
22	30	12	160
22	35	15	160
22	40	18	160
22	45	20	160
22	50	24	160
25	25	13	130
25	30	17	130
25	35	19	130
25	40	22	130
25	45	25	130
25	50	29	130
25	55	32	130

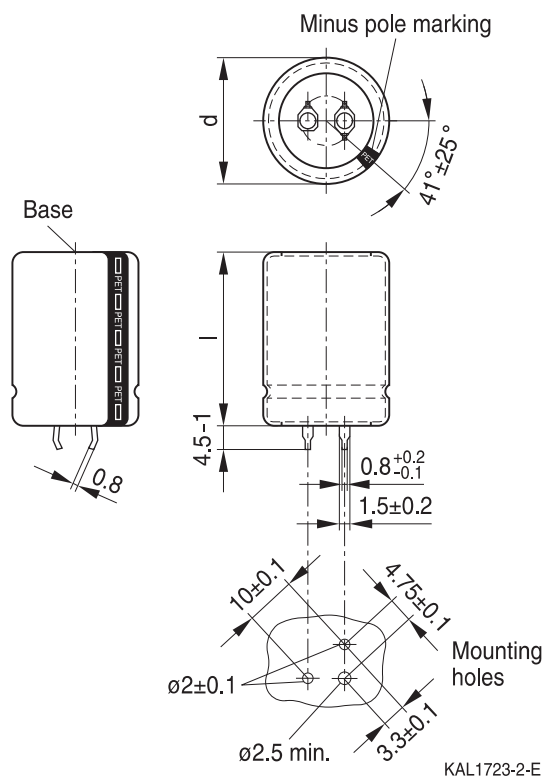

Snap-in capacitors are also available with 3 terminals (length (4.5 – 1) mm).  
 Insulation is marked with "PET" on the sleeve.  
 Safety vent on the base.

Dimensions (mm)		Approx. weight (g)	Packing units (pcs.)
d +1	l ±2		
30	25	17	80
30	30	23	80
30	35	29	80
30	40	36	80
30	45	41	80
30	50	46	80
30	55	53	80
Dimensions (mm)		Approx. weight (g)	Packing units (pcs.)
d +1	l +2.5/-2.0		
35	25	22	60
35	30	29	60
35	35	36	60
35	40	41	60
35	45	56	60
35	50	70	60
35	55	81	60



### Packing of snap-in capacitors



For ecological reasons the packing is pure cardboard.

### Ordering codes for terminal styles and insulation features

Identification in 3<sup>rd</sup> block of ordering code

Snap-in capacitors

Terminal version	Insulation
	PET sleeve
Standard terminals 6.3 mm	M050
Short terminals 4.5 mm	M057
3 terminals 4.5 mm	M052

Ordering examples:

- B43643A9157M057 } snap-in capacitor with short terminals and PET sleeve
- B43643A9157M052 } snap-in capacitor with 3 terminals and PET sleeve



**B43643**

**Ultra compact – 105 °C**

### Overview of available types

The capacitance and voltage ratings listed below are available in different case sizes upon request. Other voltage and capacitance ratings are also available upon request.

$V_R$ (V DC)	200	250	400	420	450
	Case dimensions $d \times l$ (mm)				
$C_R$ ( $\mu\text{F}$ )					
100					22 × 25
120				22 × 25	22 × 30
150			22 × 25	22 × 30 25 × 25	22 × 30 25 × 25
180			22 × 30 25 × 25	22 × 35 25 × 30	22 × 35 25 × 30
220			22 × 35 25 × 30	22 × 40 25 × 30 30 × 25	22 × 45 25 × 35 30 × 25
270		22 × 25	22 × 40 25 × 35 30 × 25	22 × 45 25 × 35 30 × 30	22 × 50 25 × 40 30 × 30
330		22 × 30	22 × 50 25 × 40 30 × 30	25 × 40 30 × 30 35 × 25	25 × 45 30 × 35 35 × 25
390	22 × 25	22 × 30 25 × 25	25 × 45 30 × 30 35 × 25	25 × 50 30 × 35 35 × 30	25 × 55 30 × 40 35 × 30
470	22 × 30	22 × 35 25 × 30	25 × 50 30 × 35 35 × 30	25 × 55 30 × 40 35 × 30	30 × 45 35 × 35
560	22 × 35 25 × 25	22 × 40 25 × 35 30 × 25	25 × 55 30 × 40 35 × 30	30 × 45 35 × 35	30 × 50 35 × 40
680	22 × 40 25 × 30	22 × 45 25 × 40 30 × 30	30 × 50 35 × 35	30 × 55 35 × 40	35 × 45



### Overview of available types

The capacitance and voltage ratings listed below are available in different case sizes upon request. Other voltage and capacitance ratings are also available upon request.

$V_R$ (V DC)	200	250	400	420	450
	Case dimensions $d \times l$ (mm)				
$C_R$ ( $\mu$ F)					
820	22 × 45 25 × 35 30 × 25	25 × 45 30 × 30 35 × 25	30 × 55 35 × 40	35 × 45	35 × 50
1000	22 × 50 25 × 40 30 × 30	25 × 50 30 × 35 35 × 30	35 × 50	35 × 55	
1200	25 × 45 30 × 35 35 × 25	30 × 40 35 × 35	35 × 55		
1500	25 × 55 30 × 40 35 × 30	30 × 50 35 × 40			
1800	30 × 45 35 × 35	35 × 45			
2200	30 × 55 35 × 40	35 × 50			
2700	35 × 50				
3300	35 × 55				



**B43643**

**Ultra compact – 105 °C**

**Technical data and ordering codes**

$C_R$ 100 Hz 20 °C $\mu\text{F}$	Case dimensions $d \times l$ mm	$\text{ESR}_{\text{typ}}$ 100 Hz 20 °C $\text{m}\Omega$	$\text{ESR}_{\text{typ}}$ 300 Hz 60 °C $\text{m}\Omega$	$Z_{\text{max}}$ 10 kHz 20 °C $\text{m}\Omega$	$I_{\text{AC,max}}$ 100 Hz 60 °C A	$I_{\text{AC,max}}$ 100 Hz 85 °C A	$I_{\text{AC,R}}$ 100 Hz 105 °C A	Ordering code (composition see below)
$V_R = 200 \text{ V DC}$								
390	22 × 25	240	80	350	2.92	2.18	1.20	B43643A2397M05#
470	22 × 30	200	65	290	3.41	2.55	1.40	B43643A2477M05#
560	22 × 35	170	55	240	3.94	2.95	1.62	B43643A2567M05#
560	25 × 25	180	70	270	3.50	2.61	1.43	B43643B2567M05#
680	22 × 40	140	45	200	4.63	3.46	1.90	B43643A2687M05#
680	25 × 30	150	55	220	4.11	3.07	1.69	B43643B2687M05#
820	22 × 45	120	40	170	5.41	4.04	2.22	B43643A2827M05#
820	25 × 35	120	45	180	4.81	3.59	1.97	B43643B2827M05#
820	30 × 25	140	70	210	3.94	2.93	1.61	B43643C2827M05#
1000	22 × 50	100	32	140	6.38	4.74	2.60	B43643A2108M05#
1000	25 × 40	100	40	150	5.65	4.21	2.31	B43643B2108M05#
1000	30 × 30	110	55	170	4.67	3.48	1.92	B43643C2108M05#
1200	25 × 45	85	32	130	6.55	4.87	2.67	B43643A2128M05#
1200	30 × 35	95	45	140	5.44	4.06	2.23	B43643B2128M05#
1200	35 × 25	120	75	190	4.24	3.15	1.73	B43643C2128M05#
1500	25 × 55	65	26	100	7.96	5.92	3.25	B43643A2158M05#
1500	30 × 40	75	36	120	6.41	4.78	2.62	B43643B2158M05#
1500	35 × 30	100	60	150	5.10	3.79	2.08	B43643C2158M05#
1800	30 × 45	65	32	100	7.38	5.49	3.01	B43643A2188M05#
1800	35 × 35	80	50	120	5.94	4.42	2.43	B43643B2188M05#
2200	30 × 55	50	26	80	8.86	6.60	3.62	B43643A2228M05#
2200	35 × 40	65	40	110	6.88	5.12	2.81	B43643B2228M05#
2700	35 × 50	50	30	80	8.39	6.25	3.43	B43643A2278M05#
3300	35 × 55	45	28	70	9.55	7.10	3.89	B43643A2338M05#

**Composition of ordering code**

# = Terminal style

0 = snap-in standard terminals (6.3 mm)

2 = snap-in 3 terminals (4.5 mm)

7 = snap-in short terminals (4.5 mm)



**Technical data and ordering codes**

$C_R$ 100 Hz 20 °C $\mu\text{F}$	Case dimensions $d \times l$ mm	$\text{ESR}_{\text{typ}}$ 100 Hz 20 °C m $\Omega$	$\text{ESR}_{\text{typ}}$ 300 Hz 60 °C m $\Omega$	$Z_{\text{max}}$ 10 kHz 20 °C m $\Omega$	$I_{\text{AC,max}}$ 100 Hz 60 °C A	$I_{\text{AC,max}}$ 100 Hz 85 °C A	$I_{\text{AC,R}}$ 100 Hz 105 °C A	Ordering code (composition see below)
<b><math>V_R = 250 \text{ V DC}</math></b>								
270	22 × 25	320	100	460	2.43	1.82	1.00	B43643E2277M05#
330	22 × 30	260	80	370	2.87	2.15	1.18	B43643E2337M05#
390	22 × 30	220	75	320	3.26	2.43	1.33	B43643E2397M05#
390	25 × 25	230	85	340	2.99	2.23	1.23	B43643F2397M05#
470	22 × 35	180	60	270	3.81	2.84	1.56	B43643E2477M05#
470	25 × 30	190	65	280	3.49	2.61	1.44	B43643F2477M05#
560	22 × 40	160	50	230	4.41	3.29	1.80	B43643E2567M05#
560	25 × 35	160	55	230	4.04	3.03	1.67	B43643F2567M05#
560	30 × 25	180	75	270	3.45	2.58	1.42	B43643G2567M05#
680	22 × 45	130	45	190	5.19	3.86	2.12	B43643E2687M05#
680	25 × 40	130	45	190	4.74	3.54	1.95	B43643F2687M05#
680	30 × 30	140	60	210	4.07	3.05	1.68	B43643G2687M05#
820	25 × 45	110	40	160	5.52	4.12	2.26	B43643E2827M05#
820	30 × 30	130	60	190	4.49	3.34	1.83	B43643F2827M05#
820	35 × 25	150	80	220	3.86	2.88	1.58	B43643G2827M05#
1000	25 × 50	90	34	140	6.48	4.82	2.64	B43643E2108M05#
1000	30 × 35	100	50	160	5.28	3.93	2.15	B43643F2108M05#
1000	35 × 30	120	60	180	4.59	3.42	1.88	B43643G2108M05#
1200	30 × 40	90	40	140	6.11	4.54	2.49	B43643E2128M05#
1200	35 × 35	100	50	150	5.32	3.98	2.19	B43643F2128M05#
1500	30 × 50	70	32	110	7.47	5.56	3.05	B43643E2158M05#
1500	35 × 40	80	45	120	6.21	4.64	2.55	B43643F2158M05#
1800	35 × 45	70	40	110	7.10	5.29	2.91	B43643E2188M05#
2200	35 × 50	60	34	90	8.14	6.06	3.32	B43643E2228M05#

**Composition of ordering code**

# = Terminal style

0 = snap-in standard terminals (6.3 mm)

2 = snap-in 3 terminals (4.5 mm)

7 = snap-in short terminals (4.5 mm)



**B43643**

**Ultra compact – 105 °C**

**Technical data and ordering codes**

$C_R$ 100 Hz 20 °C $\mu\text{F}$	Case dimensions $d \times l$ mm	$\text{ESR}_{\text{typ}}$ 100 Hz 20 °C $\text{m}\Omega$	$\text{ESR}_{\text{typ}}$ 300 Hz 60 °C $\text{m}\Omega$	$Z_{\text{max}}$ 10 kHz 20 °C $\text{m}\Omega$	$I_{\text{AC,max}}$ 100 Hz 60 °C A	$I_{\text{AC,max}}$ 100 Hz 85 °C A	$I_{\text{AC,R}}$ 100 Hz 105 °C A	Ordering code (composition see below)
<b><math>V_R = 400 \text{ V DC}</math></b>								
150	22 × 25	610	170	880	2.10	1.61	0.86	B43643A9157M05#
180	22 × 30	520	140	730	2.42	1.86	0.99	B43643A9187M05#
180	25 × 25	520	150	750	2.29	1.76	0.94	B43643B9187M05#
220	22 × 35	420	120	600	2.86	2.20	1.17	B43643A9227M05#
220	25 × 30	430	120	610	2.69	2.07	1.11	B43643B9227M05#
270	22 × 40	340	95	490	3.39	2.61	1.39	B43643A9277M05#
270	25 × 35	340	100	500	3.18	2.44	1.31	B43643B9277M05#
270	30 × 25	360	120	530	2.90	2.23	1.19	B43643C9277M05#
330	22 × 50	280	75	400	4.05	3.11	1.66	B43643A9337M05#
330	25 × 40	280	80	410	3.74	2.88	1.54	B43643B9337M05#
330	30 × 30	290	95	430	3.40	2.62	1.40	B43643C9337M05#
390	25 × 45	240	70	350	4.31	3.31	1.77	B43643A9397M05#
390	30 × 30	250	85	370	3.81	2.92	1.56	B43643B9397M05#
390	35 × 25	270	100	400	3.47	2.67	1.42	B43643C9397M05#
470	25 × 50	200	60	290	5.05	3.88	2.07	B43643A9477M05#
470	30 × 35	210	70	310	4.43	3.40	1.81	B43643B9477M05#
470	35 × 30	220	80	330	4.06	3.09	1.52	B43643C9477M05#
560	25 × 55	170	50	250	5.86	4.49	2.39	B43643A9567M05#
560	30 × 40	180	60	260	5.11	3.89	1.91	B43643B9567M05#
560	35 × 30	190	80	290	4.46	3.38	1.66	B43643C9567M05#
680	30 × 50	140	45	210	6.08	4.63	2.28	B43643A9687M05#
680	35 × 35	160	65	240	5.21	3.95	1.94	B43643B9687M05#
820	30 × 55	120	40	180	7.07	5.37	2.64	B43643A9827M05#
820	35 × 40	130	55	200	6.03	4.58	2.25	B43643B9827M05#
1000	35 × 50	110	40	160	7.22	5.49	2.70	B43643A9108M05#
1200	35 × 55	90	38	140	8.30	6.30	3.10	B43643A9128M05#

**Composition of ordering code**

# = Terminal style

0 = snap-in standard terminals (6.3 mm)

2 = snap-in 3 terminals (4.5 mm)

7 = snap-in short terminals (4.5 mm)

**Technical data and ordering codes**

$C_R$ 100 Hz 20 °C $\mu\text{F}$	Case dimensions $d \times l$ mm	$\text{ESR}_{\text{typ}}$ 100 Hz 20 °C $\text{m}\Omega$	$\text{ESR}_{\text{typ}}$ 300 Hz 60 °C $\text{m}\Omega$	$Z_{\text{max}}$ 10 kHz 20 °C $\text{m}\Omega$	$I_{\text{AC,max}}$ 100 Hz 60 °C A	$I_{\text{AC,max}}$ 100 Hz 85 °C A	$I_{\text{AC,R}}$ 100 Hz 105 °C A	Ordering code (composition see below)
<b><math>V_R = 420 \text{ V DC}</math></b>								
120	22 × 25	980	240	1470	1.68	1.26	0.73	B43643A0127M05#
150	22 × 30	770	200	1180	2.00	1.50	0.87	B43643A0157M05#
150	25 × 25	780	200	1190	1.91	1.43	0.83	B43643B0157M05#
180	22 × 35	640	160	980	2.33	1.75	1.01	B43643A0187M05#
180	25 × 30	640	170	990	2.21	1.66	0.96	B43643B0187M05#
220	22 × 40	520	130	810	2.76	2.07	1.20	B43643A0227M05#
220	25 × 30	530	140	820	2.59	1.94	1.12	B43643B0227M05#
220	30 × 25	540	150	840	2.43	1.82	1.06	B43643C0227M05#
270	22 × 45	430	110	660	3.28	2.45	1.42	B43643A0277M05#
270	25 × 35	430	120	670	3.06	2.29	1.32	B43643B0277M05#
270	30 × 30	440	120	680	2.85	2.14	1.24	B43643C0277M05#
330	25 × 40	360	95	550	3.62	2.70	1.57	B43643A0337M05#
330	30 × 30	370	110	570	3.27	2.45	1.42	B43643B0337M05#
330	35 × 25	380	120	600	3.05	2.28	1.32	B43643C0337M05#
390	25 × 50	300	80	460	4.19	3.14	1.82	B43643A0397M05#
390	30 × 35	310	90	480	3.75	2.81	1.63	B43643B0397M05#
390	35 × 30	320	100	500	3.47	2.58	1.45	B43643C0397M05#
470	25 × 55	250	65	390	4.91	3.67	2.13	B43643A0477M05#
470	30 × 40	260	75	400	4.33	3.22	1.80	B43643B0477M05#
470	35 × 30	270	95	430	3.87	2.87	1.60	B43643C0477M05#
560	30 × 45	220	65	340	4.99	3.71	2.07	B43643A0567M05#
560	35 × 35	230	75	360	4.46	3.31	1.85	B43643B0567M05#
680	30 × 55	180	50	280	5.92	4.39	2.46	B43643A0687M05#
680	35 × 40	190	65	300	5.19	3.85	2.15	B43643B0687M05#
820	35 × 45	160	55	250	6.01	4.45	2.49	B43643A0827M05#
1000	35 × 55	130	45	210	7.14	5.30	2.96	B43643A0108M05#

**Composition of ordering code**

# = Terminal style

0 = snap-in standard terminals (6.3 mm)

2 = snap-in 3 terminals (4.5 mm)

7 = snap-in short terminals (4.5 mm)



**B43643**

**Ultra compact – 105 °C**

**Technical data and ordering codes**

$C_R$ 100 Hz 20 °C $\mu\text{F}$	Case dimensions $d \times l$ mm	$\text{ESR}_{\text{typ}}$ 100 Hz 20 °C $\text{m}\Omega$	$\text{ESR}_{\text{typ}}$ 300 Hz 60 °C $\text{m}\Omega$	$Z_{\text{max}}$ 10 kHz 20 °C $\text{m}\Omega$	$I_{\text{AC,max}}$ 100 Hz 60 °C A	$I_{\text{AC,max}}$ 100 Hz 85 °C A	$I_{\text{AC,R}}$ 100 Hz 105 °C A	Ordering code (composition see below)
$V_R = 450 \text{ V DC}$								
100	22 × 25	1060	270	1610	1.51	1.13	0.66	B43643A5107M05#
120	22 × 30	880	220	1340	1.75	1.31	0.76	B43643A5127M05#
150	22 × 30	710	180	1080	2.10	1.57	0.91	B43643A5157M05#
150	25 × 25	720	190	1090	2.00	1.50	0.87	B43643B5157M05#
180	22 × 35	590	150	900	2.44	1.83	1.06	B43643A5187M05#
180	25 × 30	600	160	910	2.30	1.73	1.00	B43643B5187M05#
220	22 × 45	480	120	730	2.91	2.18	1.26	B43643A5227M05#
220	25 × 35	490	130	740	2.71	2.03	1.18	B43643B5227M05#
220	30 × 25	500	150	770	2.52	1.88	1.09	B43643C5227M05#
270	22 × 50	400	100	600	3.46	2.59	1.50	B43643A5277M05#
270	25 × 40	400	110	610	3.22	2.41	1.40	B43643B5277M05#
270	30 × 30	410	120	630	2.95	2.21	1.28	B43643C5277M05#
330	25 × 45	330	90	500	3.81	2.85	1.65	B43643A5337M05#
330	30 × 35	330	95	510	3.47	2.60	1.51	B43643B5337M05#
330	35 × 25	360	120	560	3.14	2.35	1.36	B43643C5337M05#
390	25 × 55	280	75	420	4.42	3.31	1.92	B43643A5397M05#
390	30 × 40	280	80	430	3.93	2.92	1.64	B43643B5397M05#
390	35 × 30	300	100	460	3.58	2.66	1.49	B43643C5397M05#
470	30 × 45	240	70	360	4.57	3.40	1.90	B43643A5477M05#
470	35 × 35	250	80	380	4.15	3.08	1.72	B43643B5477M05#
560	30 × 50	200	60	310	5.28	3.92	2.19	B43643A5567M05#
560	35 × 40	210	70	320	4.76	3.54	1.98	B43643B5567M05#
680	35 × 45	170	60	270	5.53	4.11	2.30	B43643A5687M05#
820	35 × 50	140	50	230	6.39	4.74	2.65	B43643A5827M05#

**Composition of ordering code**

# = Terminal style

0 = snap-in standard terminals (6.3 mm)

2 = snap-in 3 terminals (4.5 mm)

7 = snap-in short terminals (4.5 mm)

**Useful life<sup>1)</sup>**

For useful life calculations, please use our web-based "AlCap Useful Life Calculation Tool", which can be found on the Internet under the following link:

[www.tdk-electronics.tdk.com/alcap](http://www.tdk-electronics.tdk.com/alcap)

The AlCap Useful Life Calculation Tool provides calculations of useful life as well as additional data for selected capacitor types under operating conditions defined by the user.

In addition, it is possible to calculate useful life expectancies based on temperatures measured by the user in the application.

**Frequency characteristics of ESR**

Typical behavior

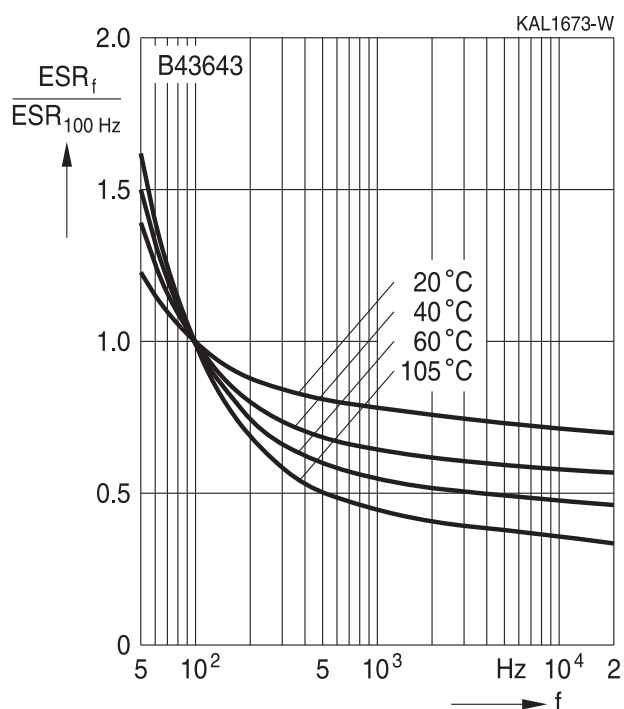
**Impedance Z versus frequency f**

Typical behavior at 20 °C

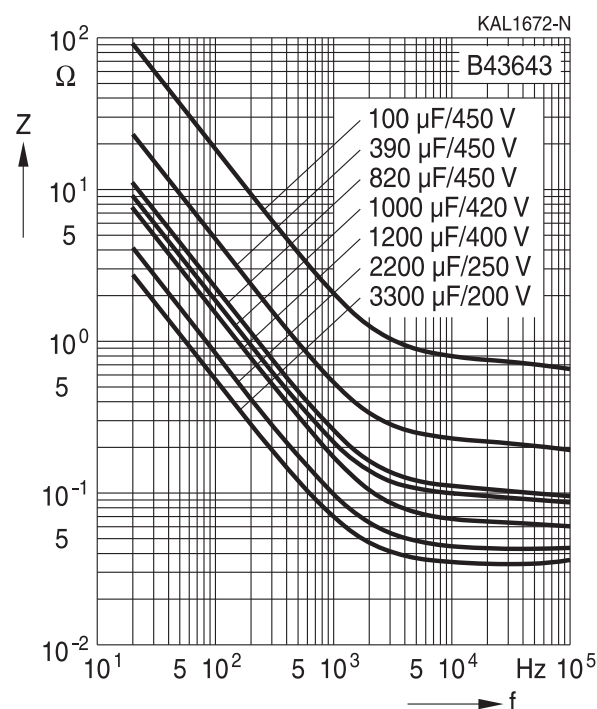

1) Refer to chapter "General technical information, 5 Useful life" on how to interpret useful life.



**B43643**

**Ultra compact – 105 °C**

## Cautions and warnings

### Personal safety

The electrolytes used have been optimized both with a view to the intended application and with regard to health and environmental compatibility. They do not contain any solvents that are detrimental to health, e.g. dimethyl formamide (DMF) or dimethyl acetamide (DMAC). Furthermore, some of the high-voltage electrolytes used are self-extinguishing.

As far as possible, we do not use any dangerous chemicals or compounds to produce operating electrolytes, although in exceptional cases, such materials must be used in order to achieve specific physical and electrical properties because no alternative materials are currently known. We do, however, restrict the amount of dangerous materials used in our products to an absolute minimum.

Materials and chemicals used in our aluminum electrolytic capacitors are continuously adapted in compliance with the TDK Electronics Corporate Environmental Policy and the latest EU regulations and guidelines such as RoHS, REACH/SVHC, GADSL, and ELV.

MDS (Material Data Sheets) are available on our website for all types listed in the data book. MDS for customer specific capacitors are available upon request.

MSDS (Material Safety Data Sheets) are available for our electrolytes upon request.

Nevertheless, the following rules should be observed when handling aluminum electrolytic capacitors: No electrolyte should come into contact with eyes or skin. If electrolyte does come into contact with the skin, wash the affected areas immediately with running water. If the eyes are affected, rinse them for 10 minutes with plenty of water. If symptoms persist, seek medical treatment. Avoid inhaling electrolyte vapor or mists. Workplaces and other affected areas should be well ventilated. Clothing that has been contaminated by electrolyte must be changed and rinsed in water.



## Product safety

The table below summarizes the safety instructions that must be observed without fail. A detailed description can be found in the relevant sections of separate file chapter "General technical information".

Topic	Safety information	Reference chapter "General technical information"
Polarity	Make sure that polar capacitors are connected with the right polarity.	1 "Basic construction of aluminum electrolytic capacitors"
Reverse voltage	Voltages of opposite polarity should be prevented by connecting a diode.	3.1.6 "Reverse voltage"
Mounting position of screw-terminal capacitors	Screw terminal capacitors must not be mounted with terminals facing down unless otherwise specified.	11.1. "Mounting positions of capacitors with screw terminals"
Robustness of terminals	The following maximum tightening torques must not be exceeded when connecting screw terminals: M5: 2.5 Nm M6: 4.0 Nm	11.3 "Mounting torques"
Mounting of single-ended capacitors	The internal structure of single-ended capacitors might be damaged if excessive force is applied to the lead wires. Avoid any compressive, tensile or flexural stress. Do not move the capacitor after soldering to PC board. Do not pick up the PC board by the soldered capacitor. Do not insert the capacitor on the PC board with a hole space different to the lead space specified.	11.4 "Mounting considerations for single-ended capacitors"
Soldering	Do not exceed the specified time or temperature limits during soldering.	11.5 "Soldering"
Soldering, cleaning agents	Do not allow halogenated hydrocarbons to come into contact with aluminum electrolytic capacitors.	11.6 "Cleaning agents"
Upper category temperature	Do not exceed the upper category temperature.	7.2 "Maximum permissible operating temperature"
Passive flammability	Avoid external energy, e.g. fire.	8.1 "Passive flammability"



**B43643**

**Ultra compact – 105 °C**

Topic	Safety information	Reference chapter "General technical information"
Active flammability	Avoid overload of the capacitors.	8.2 "Active flammability"
Maintenance	Make periodic inspections of the capacitors. Before the inspection, make sure that the power supply is turned off and carefully discharge the capacitors. Do not apply excessive mechanical stress to the capacitor terminals when mounting.	10 "Maintenance"
Storage	Do not store capacitors at high temperatures or high humidity. Capacitors should be stored at +5 to +35 °C and a relative humidity of ≤ 75%.	7.3 "Shelf life and storage conditions"
		Reference chapter "Capacitors with screw terminals"
Breakdown strength of insulating sleeves	Do not damage the insulating sleeve, especially when ring clips are used for mounting.	"Screw terminals – accessories"

### Display of ordering codes for TDK Electronics products

The ordering code for one and the same product can be represented differently in data sheets, data books, other publications, on the company website, or in order-related documents such as shipping notes, order confirmations and product labels. The varying representations of the ordering codes are due to different processes employed and do not affect the specifications of the respective products.

Detailed information can be found on the Internet under [www.tdk-electronics.tdk.com/orderingcodes](http://www.tdk-electronics.tdk.com/orderingcodes).





## Symbols and terms

Symbol	English	German
C	Capacitance	Kapazität
$C_R$	Rated capacitance	Nennkapazität
$C_S$	Series capacitance	Serienkapazität
$C_{S,T}$	Series capacitance at temperature T	Serienkapazität bei Temperatur T
$C_f$	Capacitance at frequency f	Kapazität bei Frequenz f
d	Case diameter, nominal dimension	Gehäusedurchmesser, Nennmaß
$d_{max}$	Maximum case diameter	Maximaler Gehäusedurchmesser
ESL	Self-inductance	Eigeninduktivität
ESR	Equivalent series resistance	Ersatzserienwiderstand
$ESR_f$	Equivalent series resistance at frequency f	Ersatzserienwiderstand bei Frequenz f
$ESR_T$	Equivalent series resistance at temperature T	Ersatzserienwiderstand bei Temperatur T
f	Frequency	Frequenz
I	Current	Strom
$I_{AC}$	Alternating current (ripple current)	Wechselstrom
$I_{AC,RMS}$	Root-mean-square value of alternating current	Wechselstrom, Effektivwert
$I_{AC,f}$	Ripple current at frequency f	Wechselstrom bei Frequenz f
$I_{AC,max}$	Maximum permissible ripple current	Maximal zulässiger Wechselstrom
$I_{AC,R}$	Rated ripple current	Nennwechselstrom
$I_{leak}$	Leakage current	Reststrom
$I_{leak,op}$	Operating leakage current	Betriebsreststrom
l	Case length, nominal dimension	Gehäuselänge, Nennmaß
$l_{max}$	Maximum case length (without terminals and mounting stud)	Maximale Gehäuselänge (ohne Anschlüsse und Gewindebolzen)
R	Resistance	Widerstand
$R_{ins}$	Insulation resistance	Isolationswiderstand
$R_{symm}$	Balancing resistance	Symmetrierwiderstand
T	Temperature	Temperatur
$\Delta T$	Temperature difference	Temperaturdifferenz
$T_A$	Ambient temperature	Umgebungstemperatur
$T_C$	Case temperature	Gehäusetemperatur
$T_B$	Capacitor base temperature	Temperatur des Gehäusebodens
t	Time	Zeit
$\Delta t$	Period	Zeitraum
$t_b$	Service life (operating hours)	Brauchbarkeitsdauer (Betriebszeit)



B43643

Ultra compact – 105 °C

Symbol	English	German
V	Voltage	Spannung
$V_F$	Forming voltage	Formierspannung
$V_{op}$	Operating voltage	Betriebsspannung
$V_R$	Rated voltage, DC voltage	Nennspannung, Gleichspannung
$V_S$	Surge voltage	Spitzenspannung
$X_C$	Capacitive reactance	Kapazitiver Blindwiderstand
$X_L$	Inductive reactance	Induktiver Blindwiderstand
Z	Impedance	Scheinwiderstand
$Z_T$	Impedance at temperature T	Scheinwiderstand bei Temperatur T
$\tan \delta$	Dissipation factor	Verlustfaktor
$\lambda$	Failure rate	Ausfallrate
$\epsilon_0$	Absolute permittivity	Elektrische Feldkonstante
$\epsilon_r$	Relative permittivity	Dielektrizitätszahl
$\omega$	Angular velocity; $2 \cdot \pi \cdot f$	Kreisfrequenz; $2 \cdot \pi \cdot f$

### Note

All dimensions are given in mm.

## Important notes

The following applies to all products named in this publication:

1. Some parts of this publication contain **statements about the suitability of our products for certain areas of application**. These statements are based on our knowledge of typical requirements that are often placed on our products in the areas of application concerned. We nevertheless expressly point out **that such statements cannot be regarded as binding statements about the suitability of our products for a particular customer application**. As a rule, we are either unfamiliar with individual customer applications or less familiar with them than the customers themselves. For these reasons, it is always ultimately incumbent on the customer to check and decide whether a product with the properties described in the product specification is suitable for use in a particular customer application.
2. We also point out that **in individual cases, a malfunction of electronic components or failure before the end of their usual service life cannot be completely ruled out in the current state of the art, even if they are operated as specified**. In customer applications requiring a very high level of operational safety and especially in customer applications in which the malfunction or failure of an electronic component could endanger human life or health (e.g. in accident prevention or lifesaving systems), it must therefore be ensured by means of suitable design of the customer application or other action taken by the customer (e.g. installation of protective circuitry or redundancy) that no injury or damage is sustained by third parties in the event of malfunction or failure of an electronic component.
3. **The warnings, cautions and product-specific notes must be observed.**
4. In order to satisfy certain technical requirements, **some of the products described in this publication may contain substances subject to restrictions in certain jurisdictions (e.g. because they are classed as hazardous)**. Useful information on this will be found in our Material Data Sheets on the Internet ([www.tdk-electronics.tdk.com/material](http://www.tdk-electronics.tdk.com/material)). Should you have any more detailed questions, please contact our sales offices.
5. We constantly strive to improve our products. Consequently, **the products described in this publication may change from time to time**. The same is true of the corresponding product specifications. Please check therefore to what extent product descriptions and specifications contained in this publication are still applicable before or when you place an order. We also **reserve the right to discontinue production and delivery of products**. Consequently, we cannot guarantee that all products named in this publication will always be available. The aforementioned does not apply in the case of individual agreements deviating from the foregoing for customer-specific products.
6. Unless otherwise agreed in individual contracts, **all orders are subject to our General Terms and Conditions of Supply**.

## Important notes

7. **Our manufacturing sites serving the automotive business apply the IATF 16949 standard.** The IATF certifications confirm our compliance with requirements regarding the quality management system in the automotive industry. Referring to customer requirements and customer specific requirements (“CSR”) TDK always has and will continue to have the policy of respecting individual agreements. Even if IATF 16949 may appear to support the acceptance of unilateral requirements, we hereby like to emphasize that **only requirements mutually agreed upon can and will be implemented in our Quality Management System.** For clarification purposes we like to point out that obligations from IATF 16949 shall only become legally binding if individually agreed upon.
8. The trade names EPCOS, CeraCharge, CeraDiode, CeraLink, CeraPad, CeraPlas, CSMP, CTVS, DeltaCap, DigiSiMic, ExoCore, FilterCap, FormFit, LeaXield, MiniBlue, MiniCell, MKD, MKK, MotorCap, PCC, PhaseCap, PhaseCube, PhaseMod, PhiCap, PowerHap, PQSine, PQvar, SIFERRIT, SIFI, SIKOREL, SilverCap, SIMDAD, SiMic, SIMID, SineFormer, SIOV, ThermoFuse, WindCap are **trademarks registered or pending** in Europe and in other countries. Further information will be found on the Internet at [www.tdk-electronics.tdk.com/trademarks](http://www.tdk-electronics.tdk.com/trademarks).

Release 2018-10

# Mouser Electronics

Authorized Distributor

Click to View Pricing, Inventory, Delivery & Lifecycle Information:

## EPCOS / TDK:

[B43643A5337M057](#) [B43643A9128M050](#) [B43643A9227M050](#) [B43643A9227M057](#) [B43643A9827M057](#)  
[B43643A5477M050](#) [B43643A5567M057](#) [B43643A5687M050](#) [B43643A5687M057](#) [B43643A5827M057](#)  
[B43643A9108M050](#) [B43643C5277M057](#) [B43643C5337M057](#) [B43643C5397M057](#) [B43643C9277M057](#)  
[B43643A5127M052](#) [B43643A5397M050](#) [B43643B5567M057](#) [B43643B9567M050](#) [B43643B9687M050](#)  
[B43643B9827M050](#) [B43643C5227M052](#) [B43643C5277M052](#) [B43643B5337M057](#) [B43643B5397M050](#)  
[B43643B5397M057](#) [B43643B5477M050](#) [B43643B5477M052](#) [B43643B5567M050](#) [B43643B0337M057](#)  
[B43643B0477M050](#) [B43643B0477M057](#) [B43643B5227M050](#) [B43643B5227M052](#)

Компания «Океан Электроники» предлагает заключение долгосрочных отношений при поставках импортных электронных компонентов на взаимовыгодных условиях!

Наши преимущества:

- Поставка оригинальных импортных электронных компонентов напрямую с производств Америки, Европы и Азии, а так же с крупнейших складов мира;
- Широкая линейка поставок активных и пассивных импортных электронных компонентов (более 30 млн. наименований);
- Поставка сложных, дефицитных, либо снятых с производства позиций;
- Оперативные сроки поставки под заказ (от 5 рабочих дней);
- Экспресс доставка в любую точку России;
- Помощь Конструкторского Отдела и консультации квалифицированных инженеров;
- Техническая поддержка проекта, помощь в подборе аналогов, поставка прототипов;
- Поставка электронных компонентов под контролем ВП;
- Система менеджмента качества сертифицирована по Международному стандарту ISO 9001;
- При необходимости вся продукция военного и аэрокосмического назначения проходит испытания и сертификацию в лаборатории (по согласованию с заказчиком);
- Поставка специализированных компонентов военного и аэрокосмического уровня качества (Xilinx, Altera, Analog Devices, Intersil, Interpoint, Microsemi, Actel, Aeroflex, Peregrine, VPT, Syfer, Eurofarad, Texas Instruments, MS Kennedy, Miteq, Cobham, E2V, MA-COM, Hittite, Mini-Circuits, General Dynamics и др.);

Компания «Океан Электроники» является официальным дистрибьютором и эксклюзивным представителем в России одного из крупнейших производителей разъемов военного и аэрокосмического назначения «JONHON», а так же официальным дистрибьютором и эксклюзивным представителем в России производителя высокотехнологичных и надежных решений для передачи СВЧ сигналов «FORSTAR».



## JONHON

«JONHON» (основан в 1970 г.)

Разъемы специального, военного и аэрокосмического назначения:

(Применяются в военной, авиационной, аэрокосмической, морской, железнодорожной, горно- и нефтедобывающей отраслях промышленности)

«FORSTAR» (основан в 1998 г.)

ВЧ соединители, коаксиальные кабели,  
кабельные сборки и микроволновые компоненты:

(Применяются в телекоммуникациях гражданского и специального назначения, в средствах связи, РЛС, а так же военной, авиационной и аэрокосмической отраслях промышленности).



Телефон: 8 (812) 309-75-97 (многоканальный)

Факс: 8 (812) 320-03-32

Электронная почта: [ocean@oceanchips.ru](mailto:ocean@oceanchips.ru)

Web: <http://oceanchips.ru/>

Адрес: 198099, г. Санкт-Петербург, ул. Калинина, д. 2, корп. 4, лит. А