

Ceramic Capacitor Solutions



X2Y Low ESL



High Voltage

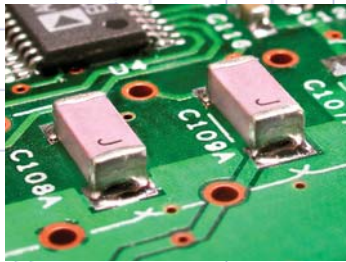

AC Safety

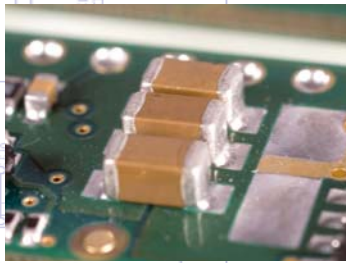

High Capacitance



Stacked SMPS

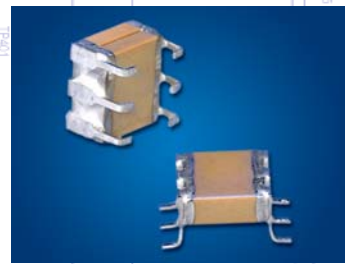

Mini-SMPS

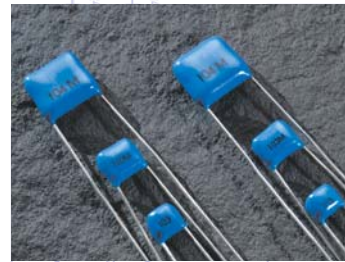

Radial Leaded

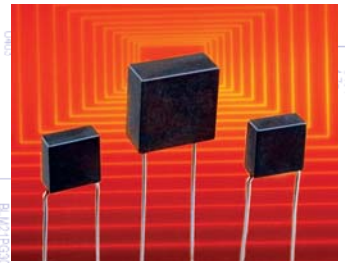

High Temperature

1. power supply, 5-12V
 2. power supply 0V
 3. lay coil positive
 4. lay coil negative
 5. output measure input, 0-100V
 6. output measure input, 0-100V
 Comment:
 USER_01
 USER_02
 USER_03
 USER_04
 USER_05
 USER_06
 USER_07
 USER_08
 USER_09
 USER_10
 USER_11
 USER_12
 USER_13
 USER_14
 USER_15
 USER_16
 USER_17
 USER_18
 USER_19
 USER_20

Your Technology Partner



The mission of the Johanson Companies is to translate our customer needs into quality electronic components, produced in factories that are models of excellence, supported by innovative service. With over 30 years of experience, Johanson Dielectrics provides both standard and custom technology solutions tailored to your specific electronic applications.

Our standard product range includes High Voltage and AC Safety Capacitors providing solutions for Lighting, IT and Business Equipment designs. Our X2Y® Capacitor line provides advanced EMI filtering and IC decoupling solutions and our High Capacitance Tanceram® products provide the highest capacitance values in the smallest cases sizes.

HIGH FREQUENCY CERAMIC SOLUTIONS

are offered by our sister company, Johanson Technology Inc., Camarillo CA. Products include High Q Capacitors, Ceramic and Wire-wound Chip Inductors, and a broad range of LTCC based RF IPCs such as Antennas, Filters, Baluns, Couplers, Matched Filter Baluns, etc.

www.johansontechnology.com

Customized solutions in the areas of High Temperature and High AC power ceramic capacitors are available to customers who require a partnered technology solution.

Johanson Dielectrics design and manufacturing operations are located in Sylmar, California and Zhoaqing, PRC. Our quality minded management system utilizes continuous improvement programs focused on increased product reliability, manufacturing throughput, and product performance. Our broad experience, applications support, and responsive service enhance our ability to drive down your total cost of procurement and speed your time to market.



Johanson Dielectrics, Inc. reserves the right to make design and price changes without notice. All sales are subject to the terms and conditions printed on the back side of our sales order acknowledgment forms, including a limited warranty and remedies for non-conforming goods or defective goods. We will be pleased to provide a copy of these terms and conditions for your review.



www.johansondielectrics.com

SURFACE MOUNT CERAMIC CAPACITORS

Ceramic Capacitor Prototyping Kits	4-5
High Voltage Capacitors 250 - 6,000 VDC	6-7
Safety Capacitors 250 VAC, Y2, Y3, Japan Standard	8-9
Low Inductance X2Y [®] Capacitors	10-13
Low Inductance Capacitors	14
Chip Feedthru Filter Capacitors	15
High Power AC Capacitors	16
High Temperature - 200°C Capacitors	17
High Capacitance Tanceram [®] Capacitors	18-19
SMT Multi-layer Ceramic Capacitors 10 - 200 VDC	20-21

LEADED CERAMIC CAPACITORS

SMPS Stacked Capacitors, 125°C & 200°C versions	22-23
Mini-SMPS Stacked Capacitors	24-25
Maxi-Cap [™] SMPS Capacitors	26-27
X2Y [®] Low ESL SMPS Stacked Capacitors	28-29
Switch-mode Radial Leaded Capacitors	30-31
High Voltage Radial Leaded Capacitors, 125°C, 200°C, 250°C versions	32-33
Part Number, Dielectric, Packaging Specifications	34-35

ON-LINE PRODUCTS

N2200 Chip Capacitors
200°C Radial Leaded Capacitors
Tin-Lead Termination Capacitors
Polyterm[®] Termination Capacitors
Large Size Multi-layer Ceramic Capacitors
X2Y Filter Eval. & PCB Design Guide

ON-LINE INFORMATION

Dielectric Characteristics
Packaging & Marking
Environmental Compliance Policies
Lead-Free Reflow Processing
High Voltage PCB Design
Capacitor Power Handling



CERAMIC CAPACITOR ENGINEERING DESIGN KITS

Johanson Dielectrics, Inc. offers a variety of multi-layer chip capacitor sample kits for proto-type design work. Each kit is grouped by type, size, or voltage and contains a selection of popular values and tolerances. The chips are individually packaged in labeled plastic compartments for easy access. The general range of kit contents is described below. Specific part number details may be found at JohansonDielectrics.com



0402 CERAMIC CHIP CAPACITOR KIT					P/N: S-0402
1400 piece sample assortment of selected values from 1.0pF to 0.1µF					
Chip Size	Voltage Rating	Dielectric	Capacitanc Range	Qty / Value	Total Qty
0402	50 VDC - 6.3 VDC	NPO, X7R,Y5V	1.0pF to 0.22µF	50 pcs	1400 pcs

0603 CERAMIC CHIP CAPACITOR KIT					P/N: S-0603
1400 piece sample assortment of selected values from 1.0pF to 0.1µF					
Chip Size	Voltage Rating	Dielectric	Capacitanc Range	Qty / Value	Total Qty
0603	50 VDC - 16 VDC	NPO, X7R,Y5V	10pF to 0.22µF	50 pcs	1400 pcs

0805 CERAMIC CHIP CAPACITOR KIT					P/N: S-0805
1400 piece sample assortment of selected values from 1.0pF to 0.1µF					
Chip Size	Voltage Rating	Dielectric	Capacitanc Range	Qty / Value	Total Qty
0805	100 VDC - 16 VDC	NPO, X7R	10pF to 0.47µF	50 pcs	1400 pcs

TANCERAM® HIGH CAPACITANCE CERAMIC CHIP CAPACITOR KIT					P/N: S-TAN-X5R
500 piece sample assortment of selected values from 1.0µF to 100µF					
Chip Size	Voltage Rating	Dielectric	Capacitanc Range	Qty / Value	Total Qty
0402, 0603, 0805 1206, 1210	25 VDC - 6.3 VDC	X5R	1.0µF - 100µF	10 - 25 pcs	500 pcs

500 VDC CERAMIC CHIP CAPACITOR KIT					P/N: S-500
400 piece sample assortment of selected values from 33pF to 0.1µF					
Chip Size	Voltage Rating	Dielectric	Capacitanc Range	Qty / Value	Total Qty
0805 - 1812	500 VDC	NPO, X7R	33pF to 0.1µF	10-20 pcs	400 pcs

1000 VDC CERAMIC CHIP CAPACITOR KIT					P/N: S-1KV
400 piece sample assortment of selected values from 22pF to 0.1µF					
Chip Size	Voltage Rating	Dielectric	Capacitanc Range	Qty / Value	Total Qty
0805 - 2225	1000 VDC	NPO, X7R	22pF to 0.1µF	10-20 pcs	400 pcs

Johanson may from time-time adjust actual kit contents based on design demand trends. Check the Johanson web site for design kit updates and kit content changes.

2000 VDC CERAMIC CHIP CAPACITOR KIT					P/N: S-2KV
300 piece sample assortment of selected values from 22pF to 0.022μF					
Chip Size	Voltage Rating	Dielectric	Capacitanc Range	Qty / Value	Total Qty
1206 - 2225	2000 VDC	NPO, X7R	22pF to 0.022μF	10-20 pcs	300 pcs

X2/Y3 SAFETY CERTIFIED CERAMIC CHIP CAPACITOR KIT					P/N: S-SY3
240 piece sample assortment of selected values from 10pF to 1500 pF					
Chip Size	Voltage Rating	Dielectric	Capacitanc Range	Qty / Value	Total Qty
1808	3KV DC / 250 AC	NPO, X7R	10pF to 1500 pF	20 pcs	240 pcs

X1/Y2 SAFETY CERTIFIED CERAMIC CHIP CAPACITOR KIT					P/N: S-SY2
200 piece sample assortment of selected values from 10pF to 2200 pF					
Chip Size	Voltage Rating	Dielectric	Capacitanc Range	Qty / Value	Total Qty
1808 - 2220	5KV DC / 250 AC	NPO, X7R	10pF to 2200pF	20 pcs	200 pcs

X2Y® EMI FILTER CAPACITOR KIT - 0402 SIZE					P/N: S-X07CBK
600 piece sample assortment of selected values from 1.0pF to 0.01μF					
Chip Size	Voltage Rating	Dielectric	Capacitanc Range	Qty / Value	Total Qty
0402	10 - 50 VDC	NPO, X7R	1.0pF to 0.01μF	50 pcs	600 pcs

X2Y® EMI FILTER CAPACITOR KIT - 0603 SIZE					P/N: S-X14CBK
700 piece sample assortment of selected values from 1.0pF to 0.01μF					
Chip Size	Voltage Rating	Dielectric	Capacitanc Range	Qty / Value	Total Qty
0603	50 - 100 VDC	NPO, X7R	1.0pF to 0.01μF	50 pcs	700 pcs

X2Y® POWER BYPASS CAPACITOR KIT - 0603 SIZE					P/N: S-X14-PBP
300 piece sample assortment of selected values from 1.0nF to 1.0μF					
Chip Size	Voltage Rating	Dielectric	Capacitanc Range	Qty / Value	Total Qty
0603	6.3 - 100 VDC	X7R, X5R	1.0nF to 1.0μF	20 pcs	300 pcs

X2Y® EMI FILTER CAPACITOR KIT - 0805 SIZE					P/N: S-X15-EMI
300 piece sample assortment of selected values from 1.0pF to 0.01μF					
Chip Size	Voltage Rating	Dielectric	Capacitanc Range	Qty / Value	Total Qty
0805	50 - 100 VDC	NPO, X7R	1.0pF to 0.01μF	20 pcs	300 pcs

X2Y® DC MOTOR FILTER CAPACITOR KIT					P/N: S-X2Y-MTR
300 piece sample assortment of selected values from 0.10μF to 0.47μF					
Chip Size	Voltage Rating	Dielectric	Capacitanc Range	Qty / Value	Total Qty
1206 - 1812	100 VDC	X7R	0.10μF to 0.47μF	30 pcs	300 pcs

Johanson may from time-time adjust actual kit contents based on design demand trends. Check the Johanson web site for design kit updates and kit content changes.



HIGH VOLTAGE SURFACE MOUNT MLCCs 250 - 6,000 VDC



These high voltage capacitors feature a special internal electrode design which reduces voltage concentrations by distributing voltage gradients throughout the entire capacitor. This unique design also affords increased capacitance values in a given case size and voltage rating. The capacitors are designed and manufactured to the general requirement of EIA198 and are subjected to a 100% electrical testing making them well suited for a wide variety of telecommunication, commercial, and industrial applications.





APPLICATIONS

- Analog & Digital Modems
- Lighting Ballast Circuits
- DC-DC Converters
- LAN/WAN Interface
- Voltage Multipliers
- Back-lighting Inverters

NOW AVAILABLE with Polyterm® soft termination option for demanding environments & processes. Visit our website for full details.

CASE SIZE

CAPACITANCE SELECTION

JDI /EIA	Inches	(mm)	Rated Voltage	NPO Dielectric		X7R Dielectric		
				Minimum	Maximum	Minimum	Maximum	
R15/0805 	L	.080 ±.010	(2.03 ±.25)	250 VDC	-	-	1000 pF	0.022 µF
	W	.050 ±.010	(1.27 ±.25)	500 VDC	10 pF	680 pF	1000 pF	0.010 µF
	T	.055 Max.	(1.40)	630 VDC	10 pF	560 pF	1000 pF	6800 pF
	E/B	.020 ±.010	(0.51±.25)	1000 VDC	10 pF	390 pF	100 pF	4700 pF
R18/1206 	L	.125 ±.010	(3.17 ±.25)	250 VDC	-	-	1000 pF	0.068 µF
	W	.062 ±.010	(1.57 ±.25)	500 VDC	10 pF	1500 pF	1000 pF	0.047 µF
	T	.067 Max.	(1.70)	630 VDC	10 pF	1200 pF	1000 pF	0.027 µF
	E/B	.020 ±.010	(0.51±.25)	1000 VDC	10 pF	1000 pF	100 pF	0.018 µF
				2000 VDC	10 pF	220 pF	100 pF	4700 pF
				3000 VDC	10 pF	82 pF	100 pF	1000 pF
S41/1210 	L	.125 ±.010	(3.18 ±.25)	250 VDC	-	-	1000 pF	0.220 µF
	W	.095 ±.010	(2.41 ±.25)	500 VDC	10 pF	3900 pF	1000 pF	0.100 µF
	T	.080 Max.	(2.03)	630 VDC	10 pF	2700 pF	1000 pF	0.056 µF
	E/B	.020 ±.010	(0.51±.25)	1000 VDC	10 pF	1800 pF	100 pF	0.047 µF
				2000 VDC	10 pF	560 pF	100 pF	3900 pF
				3000 VDC	10 pF	220 pF	100 pF	2700 pF
R29/1808 	L	.189 ±.010	(4.80 ±.25)	500 VDC	10 pF	4700 pF	1000 pF	0.100 µF
	W	.080 ±.010	(2.03 ±.25)	630 VDC	10 pF	3300 pF	1000 pF	0.068 µF
	T	.085 Max.	(2.16)	1000 VDC	1.0 pF	2200 pF	100 pF	0.047 µF
	E/B	.020 ±.010	(0.51±.25)	2000 VDC	1.0 pF	820 pF	100 pF	8200 pF
				3000 VDC	1.0 pF	470 pF	100 pF	3900 pF
				4000 VDC	1.0 pF	180 pF	100 pF	2200 pF
				5000 VDC	1.0 pF	75 pF	47 pF	1000 pF
				6000 VDC	1.0 pF	75 pF	47 pF	100 pF





Available cap. values include these significant retma values and their multiples: 1.0 1.2 1.5 1.8 2.2 2.7 3.3 3.9 4.7 5.6 6.8 8.2 (1.0 = 1.0, 10, 100, 1000, etc.) Consult factory for non-retma values and sizes or voltages not shown.



HIGH VOLTAGE SURFACE MOUNT MLCCs 250 - 6,000 VDC

CASE SIZE

CAPACITANCE SELECTION

JDI /EIA	Inches (mm)		Rated Voltage	NPO Dielectric		X7R Dielectric		
				Minimum	Maximum	Minimum	Maximum	
S43 / 1812 			250 VDC	-	-	0.010 µF	0.470 µF	
			500 VDC	100 pF	8200 pF	1000 pF	0.330 µF	
			630 VDC	100 pF	6800 pF	1000 pF	0.180 µF	
	L	.180 ±.010 (4.57 ±.25)	1000 VDC	10 pF	5600 pF	1000 pF	0.100 µF	
	W	.125 ±.010 (3.17 ±.25)	2000 VDC	10 pF	1800 pF	100 pF	0.010 µF	
	T	.110 Max. (2.80)	3000 VDC	10 pF	1000 pF	100 pF	6800 pF	
	E/B	.025 ±.015 (0.64±.38)	4000 VDC	10 pF	390 pF	100 pF	2200 pF	
			5000 VDC	10 pF	150 pF	100 pF	1000 pF	
			6000 VDC	10 pF	150 pF	10 pF	680 pF	
	S49 / 1825 			500 VDC	100 pF	0.018 µF	0.01 µF	1.000 µF
		630 VDC	100 pF	0.015 µF	0.01 µF	0.270 µF		
		1000 VDC	10 pF	0.012 µF	1000 pF	0.047 µF		
L		.180 ±.010 (4.57 ±.25)	2000 VDC	10 pF	5600 pF	100 pF	0.022 µF	
W		.250 ±.010 (6.35 ±.25)	3000 VDC	10 pF	2200 pF	100 pF	0.010 µF	
T		.140 Max. (3.56)	4000 VDC	10 pF	1200 pF	100 pF	2700 pF	
E/B		.025 ±.015 (0.64±.38)	5000 VDC	10 pF	390 pF	100 pF	1200 pF	
		6000 VDC	10 pF	390 pF	100 pF	820 pF		
S47 / 2220 				500 VDC	1000 pF	0.018 µF	0.01 µF	0.680 µF
				630 VDC	1000 pF	0.018 µF	0.01 µF	0.470 µF
			1000 VDC	100 pF	0.015 µF	1000 pF	0.100 µF	
	L	.225 ±.015 (5.72 ±.38)	2000 VDC	100 pF	5600 pF	1000 pF	0.047 µF	
	W	.200 ±.015 (5.08 ±.38)	3000 VDC	10 pF	2700 pF	100 pF	0.015 µF	
	T	.150 Max. (3.81)	4000 VDC	10 pF	1500 pF	100 pF	3300 pF	
	E/B	.025 ±.015 (0.64±.38)	5000 VDC	10 pF	470 pF	100 pF	2200 pF	
			6000 VDC	10 pF	470 pF	100 pF	1500 pF	
	S48 / 2225 			500 VDC	1000 pF	0.027 µF	0.01 µF	1.000 µF
				630 VDC	1000 pF	0.022 µF	0.01 µF	0.680 µF
		1000 VDC	100 pF	0.018 µF	1000 pF	0.220 µF		
L		.225 ±.010 (5.72 ±.25)	2000 VDC	100 pF	8200 pF	1000 pF	0.100 µF	
W		.255 ±.015 (6.48 ±.38)	3000 VDC	10 pF	3300 pF	100 pF	0.022 µF	
T		.160 Max. (4.06)	4000 VDC	10 pF	1800 pF	100 pF	0.010 µF	
E/B		.025 ±.015 (0.64±.38)	5000 VDC	10 pF	470 pF	100 pF	3300 pF	
		6000 VDC	10 pF	470 pF	100 pF	1500 pF		

Available cap. values include these significant retma values and their multiples: 1.0 1.2 1.5 1.8 2.2 2.7 3.3 3.9 4.7 5.6 6.8 8.2 (1.0 = 1.0, 10, 100, 1000, etc.) Consult factory for non-retma values and sizes or voltages not shown.

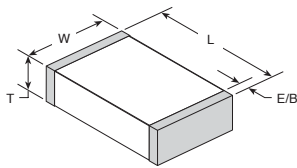

ELECTRICAL CHARACTERISTICS

Meets the standard NPO & X7R dielectric specifications listed on page 20

Dielectric Withstanding Voltage

DWV = 1.5 X rated WVDC for ratings ≤ 500 WVDC,

DWV = 1.2 X rated WVDC for ratings ≥ 1,000 WVDC

NOTE: Capacitors may require a surface coating to prevent external arcing. Solder mask should not be used beneath capacitors. For more information see JDI Tech Note "Surface Arc Season"

HOW TO ORDER HIGH VOLTAGE SURFACE MOUNT

P/N written: 202R18W102KV4E

202	R18	W	102	K	V	4	E
VOLTAGE	SIZE	DIELECTRIC	CAPACITANCE	TOLERANCE	TERMINATION	MARKING	PACKING
501 = 500 V 631 = 630 V 102 = 1000 V 202 = 2000 V 302 = 3000 V 402 = 4000 V 502 = 5000 V 602 = 6000 V	R15=0805 R18=1206 R29=1808 S41=1210 S43=1812 S47=2220 S48=2225 S49=1825	N = NPO W = X7R	1st two digits are significant; third digit denotes number of zeros. 102 = 1000 pF 104 = 0.10 µF	J = ± 5% K = ± 10% M = ± 20%	V = Ni Barrier with 100% Sn Plating (Matte) F = Polyterm flexible termination T = SnPb	4 = Unmarked 6 = EIA Code	E = Embossed 7" T = Punched 7" No code = bulk Tape specs. per EIA RS481



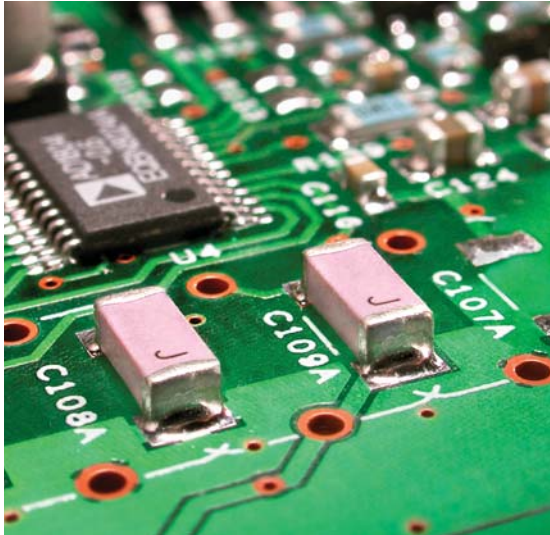

Johanson Dielectrics Type SC ceramic chip capacitors are designed for AC voltage surge and lightning protection in line-to-ground interface applications in computer networks, modem, facsimile and other equipment. Johanson's safety capacitor offering includes four different case sizes and NPO and X7R dielectric materials. These devices are surface mount ready with barrier terminations and tape and reel packaging. Information on capacitor safety ratings and certification details may be found below.

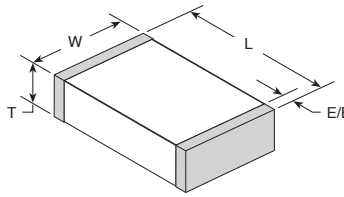

Polyterm® soft termination option available for demanding environments & processes.

SAFETY RATING	VOLTAGE RATING	WITHSTANDING VOLTAGE	IMPULSE VOLTAGE	CASE SIZE	JOHANSON ORDERING P/N
X2/Y3	250 VAC	1,500 VAC	2,500 V	1808	302R29____V3E-****-SC
STANDARDS: EN 60384-14:2005, EN 60950 2001 • UL 60950-01 CERTIFICATIONS: TUV Rheinland T72110251 • UL File E212609 • Semko 0026092-1 & 0003222-1					
Y3	250 VAC	1,500 VAC	2,500 V	1812	302S43____V3E-****-SC
STANDARDS: EN 60384-14:2005, EN 60950:2001 CERTIFICATIONS: TUV Rheinland T72110251					
X1/Y2	250 VAC	1,500 VAC	5,000 V	1808	502R29____V3E-****-SC
STANDARDS: EN 60384-14:2005 • UL 60950-01 CERTIFICATIONS: TUV Rheinland T72110897 / UL File E212609-A1-UL-1					
Y2	250 VAC	1,500 VAC	5,000 V	2211	502R30____V3E-****-SC
STANDARDS: EN 60384-14:2005 • UL 60950-01 CERTIFICATIONS: TUV Rheinland T72110897 • UL File: E212609-A1-UL-1					
X1/Y2	250 VAC	1,500 VAC	5,000 V	2220	502S47____V3E-****-SC
STANDARDS: EN 60384-14:2005 • UL 60950-01 CERTIFICATIONS: TUV Rheinland T72110897 • UL File: E212609-A1-UL-1					
Japan	250 VAC	1,500 VAC	N/A	2220	AC2____V4E-****-JS
STANDARDS: JIS-C-5102 • JIS-C-5150 CERTIFICATIONS: N/A					
X Capacitors are defined as suitable for use in situations where failure of the capacitor would not lead to danger of electric shock. Y Capacitors are defined as suitable for use in situations where failure of the capacitor could lead to danger of electric shock.					





HOW TO ORDER AC SAFETY CAPACITORS

P/N written: 302R29W102MV3E-****-SC

302	R29	W	102	M	V	3	E	-****-SC
VOLTAGE	SIZE	DIELECTRIC	CAPACITANCE	TOLERANCE	TERMINATION	MARKING	PACKING	TYPE
302 = 250VAC [3000V Impulse] 502 = 250VAC [5000V Impulse] AC2 = 250VAC [N/A]	R29=1808 R30=2211 S43=1812 S47=2220 AC2=2220	N = NPO W = X7R	1st two digits are significant; third digit denotes number of zeros, R = decimal. 102 = 1000 pF 104 = 0.10 µF 5R0 = 5.0pF	J = ± 5% K = ± 10% M = ± 20%	V = Ni Barrier with 100% Sn Plating (Matte) F = Polyterm flexible termination	3 = Special 4 = Unmarked	E = Embossed 7" No code = bulk Tape specs. per EIA RS481	SC = Safety Certified JS = Japan Safety



SAFETY CERTIFIED



			5 pF	10 pF	12 pF	15 pF	18 pF	22 pF	27 pF	33 pF	47 pF	56 pF	68 pF	100 pF	120 pF	150 pF	180 pF	220 pF	270 pF	330 pF	470 pF	560 pF	680 pF	1000 pF	1200 pF	1500 pF	1800 pF	2200 pF	2700 pF	3300 pF	4700 pF						
R29 / 1808  X2/Y3	INCHES	(mm)																																			
	L	.189 ±.010	(4.80 ±.25)																																		
	W	.080 ±.010	(2.03 ±.25)																																		
	T	.085 Max.	(2.16)																																		
	E/B	.020 ±.010	(0.51±.25)																																		
S43 / 1812  Y3	INCHES	(mm)																																			
	L	.175 ±.010	(4.45 ±.25)																																		
	W	.125 ±.010	(3.17 ±.25)																																		
	T	.115 Max.	(2.92)																																		
	E/B	.025 ±.015	(0.64±.38)																																		
R29 / 1808  X1/Y2	INCHES	(mm)																																			
	L	.189 ±.010	(4.80 ±.25)																																		
	W	.080 ±.010	(2.03 ±.25)																																		
	T	.085 Max.	(2.16)																																		
	E/B	.012 ±.005	(0.30±.13)																																		
R30 / 2211  Y2	INCHES	(mm)																																			
	L	.225 ±.016	(5.72 ±.40)																																		
	W	.110 ±.010	(2.80 ±.25)																																		
	T	.115 Max.	(2.92)																																		
	E/B	.020 ±.010	(0.51±.25)																																		
S47 / 2220  X1/Y2	INCHES	(mm)																																			
	L	.225 ±.015	(5.72 ±.38)																																		
	W	.200 ±.015	(5.08 ±.38)																																		
	T	.150 Max.	(3.81)																																		
	E/B	.025 ±.015	(0.64±.38)																																		

DIELECTRIC

NPO

X7R

JAPAN STANDARD

			470pF	1000pF	2200pF	3300pF	4700pF	0.01µF	0.022µF	0.047µF	0.10µF	
J29 / 1808  Japan Safety	INCHES	(mm)										
	L	.189 ±.010	(4.80 ±.25)									
	W	.080 ±.010	(2.03 ±.25)									
	T	.085 Max.	(2.16)									
	E/B	.020 ±.010	(0.51±.25)									
J43 / 1812  Japan Safety	INCHES	(mm)										
	L	.175 ±.010	(4.45 ±.25)									
	W	.125 ±.010	(3.17 ±.25)									
	T	.115 Max.	(2.92)									
	E/B	.025 ±.015	(0.64±.38)									
J47 / 2220  Japan Safety	INCHES	(mm)										
	L	.225 ±.015	(5.72 ±.38)									
	W	.200 ±.015	(5.08 ±.38)									
	T	.150 Max.	(3.81)									
	E/B	.025 ±.015	(0.64±.38)									



X2Y® FILTER & DECOUPLING CAPACITORS

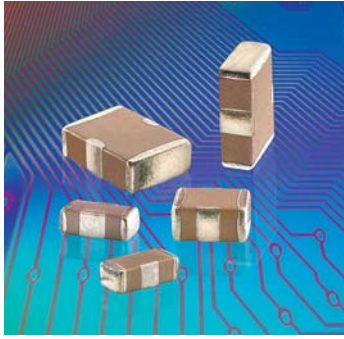

X2Y® filter capacitors employ a unique, patented low inductance design featuring two balanced capacitors that are immune to temperature, voltage and aging performance differences. These components offer superior decoupling and EMI filtering performance, virtually eliminate parasitics, and can replace multiple capacitors and inductors saving board space and reducing assembly costs.

ADVANTAGES

- One device for EMI suppression or decoupling
- Replace up to 7 components with one X2Y
- Differential and common mode attenuation
- Matched capacitance line to ground, both lines
- Low inductance due to cancellation effect

APPLICATIONS

- Amplifier Filter & Decoupling
- High Speed Data Filtering
- EMC I/O Filtering
- FPGA / ASIC / μ -P Decoupling
- DDR Memory Decoupling

EMI Filtering (1 Y-Cap.)		<10pF	10pF	22pF	27pF	33pF	47pF	100pF	220pF	470pF	1000pF	1500pF	2200pF	4700pF	.010 μ F	.015 μ F	.022 μ F	.039 μ F	.047 μ F	0.10 μ F	0.18 μ F	0.22 μ F	0.33 μ F	0.40 μ F	0.47 μ F	1.0 μ F	
Power Bypass (2 Y-Caps.)		<20pF	20pF	44pF	54pF	66pF	94pF	200pF	440pF	940pF	2000pF	3000pF	4400pF	9400pF	.020 μ F	.030 μ F	.044 μ F	.078 μ F	.094 μ F	0.20 μ F	0.36 μ F	0.44 μ F	0.68 μ F	0.80 μ F	0.94 μ F	2.0 μ F	
SIZE	CAP. CODE	XRX	100	220	270	330	470	101	221	471	102	152	222	472	103	153	223	393	473	104	184	224	334	404	474	105	
0402 (X07)	NPO	50	50	50	50	50	50																				
	X7R								50	50	50	50	50	50	16												
0603 (X14)	NPO	100	100	100	100	100	50	50	50																		
	X7R						100	100	100	100	100	100	100	100	50	25	25		16	10		6.3					
	X5R																					16	10		10	10	
0805 (X15)	NPO		100	100	100	100	100	100	100	50																	
	X7R							100	100	100	100	100	100	100	100	50	50		50	25	10						
1206 (X18)	NPO										100																
	X7R														100	100	100		100	100		16	16		10		
1210 (X41)	X7R														500				100		100	100		25	16		
1410 (X44)	X7R															500								100			
1812 (X43)	X7R																	500							100		

Contact factory for part combinations not shown.
Filtering capacitance is specified as Line-to-Ground (Terminal A or B to G) Power Bypass capacitance is specified Power-to-Ground (A + B to G)
Rated voltage is from line to ground in Circuit 1, power to ground in Circuit 2 .

HOW TO ORDER X2Y® FILTER & DECOUPLING CAPACITORS

P/N written: 101X14W102MV4T

100	X14	W	102	M	V	4	T
VOLTAGE	SIZE	DIELECTRIC	CAPACITANCE	TOLERANCE	TERMINATION	MARKING	PACKING
6R3 = 6.3 V 100 = 10 V 160 = 16 V 250 = 25 V 500 = 50 V 101 = 100 V 501 = 500 V	X07=0402 X14=0603 X15=0805 X18=1206 X41=1210 X44=1410 X43=1812	N = NPO W = X7R X = X5R	1st two digits are significant; third digit denotes number of zeros, R = decimal. 102 = 1000 pF 104 = 0.10 μ F 5R6 = 5.6pF	M = \pm 20% * D = \pm 0.50 pF *Values < 10 pF only	V = Ni Barrier with 100% Tin Plating (Matte) F = Polyterm flexible termination T = SnPb	4 = Unmarked (Not available)	E = Embossed 7" T = Punched 7" No code = bulk Tape specs. per EIA RS481

X2Y® technology patents and registered trademark under license from X2Y ATTENUATORS, LLC



EMI Filtering S21 Signal-to-Ground

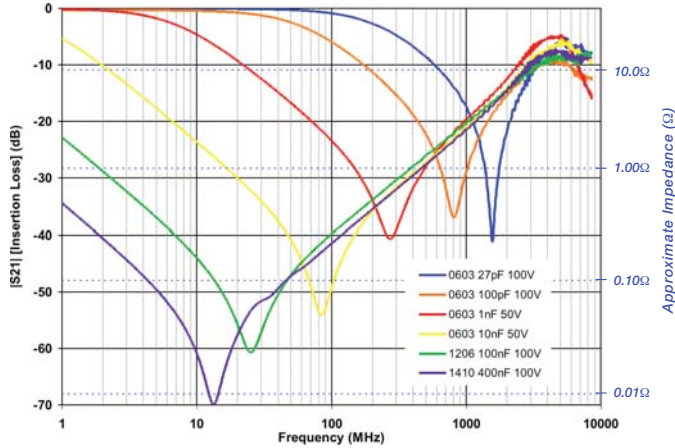
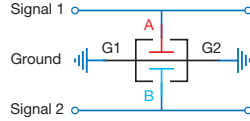

Power Bypass S21 Power-to-Ground

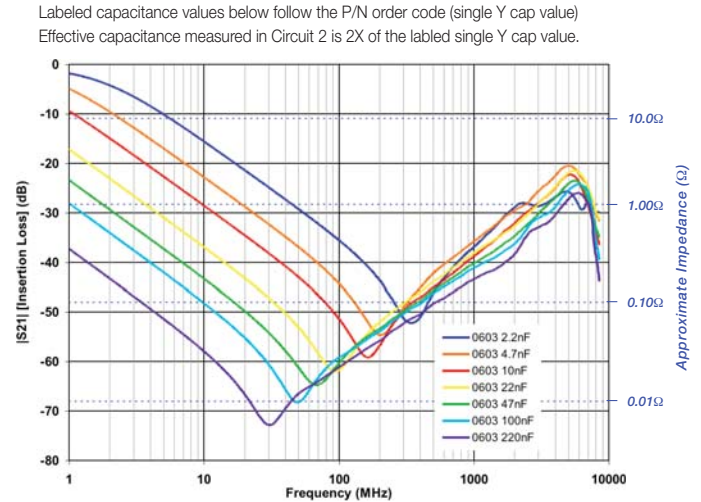
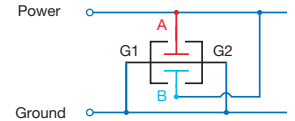

Labeled capacitance values below follow the P/N order code (single Y cap value)
Effective capacitance measured in Circuit 2 is 2X of the labeled single Y cap value.

ELECTRICAL CHARACTERISTICS

	NPO	X7R	X5R
Temperature Coefficient:	±15% (-55 to +125°C)	±15% (-55 to +125°C)	±15% (-55 to +85°C)
Dielectric Strength:	Rated ≤100VDC: DWV = 2.5 X WVDC, 25°C, 50mA max.		Rated = 500VDC: DWV = 1.5 X WVDC, 25°C, 50mA max.
Dissipation Factor:	0.1% max.	WVDC ≥ 50 VDC: 2.5% max. WVDC = 25 VDC: 3.5% max. WVDC = 10-16 VDC: 5.0% max. WVDC = 6.3 VDC: 10% max.	WVDC ≥ 50 VDC: 5% max. WVDC ≤ 25 VDC: 10% max.
Insulation Resistance (Min. @ 25°C, WVDC)	C ≤ 0.047μF: 1000 ΩF or 100 GΩ, whichever is less C > 0.047μF: 500 ΩF or 10 GΩ, whichever is less		
Test Conditions:	C > 100 pF; 1kHz ±50Hz; 1.0±0.2 VRMS C ≤ 100 pF; 1MHz ±50kHz; 1.0±0.2 VRMS	1.0kHz±50Hz @ 1.0±0.2 Vrms	
Other:	See main catalog page 35 for additional dielectric specifications.		

Equivalent Circuits

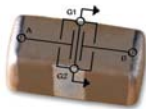
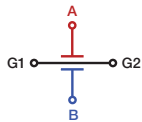

Cross-sectional View

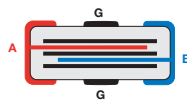

Dimensional View

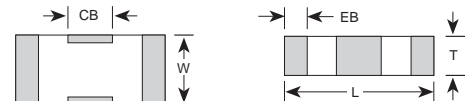

CASE SIZE

	0402 (X07)		0603 (X14)		0805 (X15)		1206 (X18)		1210 (X41)		1410 (X44)		1812 (X43)	
	IN	mm	IN	mm	IN	mm	IN	mm	IN	mm	IN	mm	IN	mm
L	0.045 ± 0.003	1.143 ± 0.076	0.064 ± 0.005	1.626 ± 0.127	0.080 ± 0.008	2.032 ± 0.203	0.124 ± 0.010	3.150 ± 0.254	0.125 ± 0.010	3.175 ± 0.254	0.140 ± 0.010	3.556 ± 0.254	0.174 ± 0.010	4.420 ± 0.254
W	0.025 ± 0.003	0.635 ± 0.076	0.035 ± 0.005	0.889 ± 0.127	0.050 ± 0.008	1.270 ± 0.203	0.063 ± 0.010	1.600 ± 0.254	0.098 ± 0.010	2.489 ± 0.254	0.098 ± 0.010	2.490 ± 0.254	0.125 ± 0.010	3.175 ± 0.254
T	0.020 max	0.508 max	0.026 max	0.660 max	0.040 max	1.016 max	0.050 max	1.270 max	0.070 max	1.778 max	0.070 max	1.778 max	0.090 max	2.286 max
EB	0.008 ± 0.003	0.203 ± 0.076	0.010 ± 0.006	0.254 ± 0.152	0.012 ± 0.008	0.305 ± 0.203	0.016 ± 0.010	0.406 ± 0.254	0.018 ± 0.010	0.457 ± 0.254	0.018 ± 0.010	0.457 ± 0.254	0.022 ± 0.012	0.559 ± 0.305
CB	0.012 ± 0.003	0.305 ± 0.076	0.018 ± 0.004	0.457 ± 0.102	0.022 ± 0.005	0.559 ± 0.127	0.040 ± 0.005	1.016 ± 0.127	0.045 ± 0.005	1.143 ± 0.127	0.045 ± 0.005	1.143 ± 0.127	0.045 ± 0.005	1.143 ± 0.127



The X2Y® Design - A Balanced, Low ESL, “Capacitor Circuit”

The X2Y® capacitor design starts with standard 2 terminal MLC capacitor’s opposing electrode sets, A & B, and adds a third electrode set (G) which surround each A & B electrode. The result is a highly versatile three node capacitive circuit containing two tightly matched, low inductance capacitors in a compact, four-terminal SMT chip.

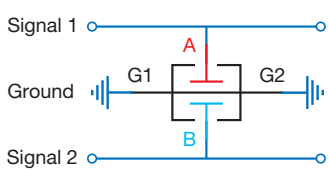
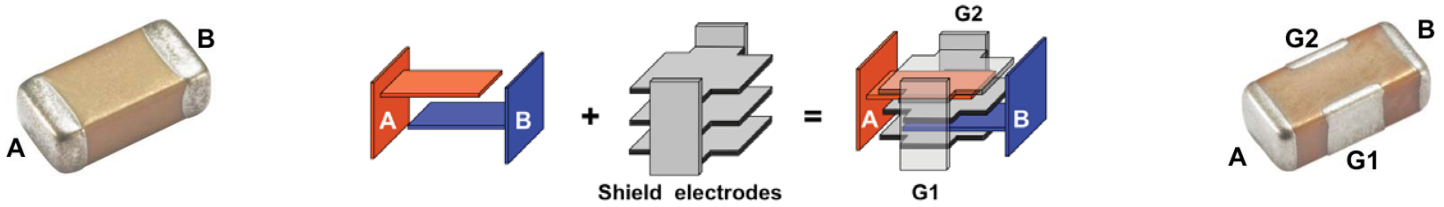

EMI Filtering:

The X2Y® component contains two shunt or “line-to-ground” Y capacitors. Ultra-low ESL (equivalent series inductance) and tightly matched inductance of these capacitors provides unequalled high frequency Common-Mode noise filtering with low noise mode conversion. X2Y® components reduce EMI emissions far better than unbalanced discrete shunt capacitors or series inductive filters. Differential signal loss is determined by the cut off frequency of the single line-to-ground (Y) capacitor value of an X2Y.

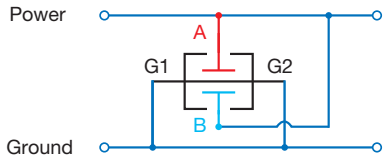

Power Bypass / Decoupling

For Power Bypass applications, X2Ys® two “Y” capacitors are connected in parallel. This doubles the total capacitance and reduces their mounted inductance by 80% or 1/5th the mounted inductance of similar sized MLC capacitors enabling high-performance bypass networks with far fewer components and vias. Low ESL delivers improved High Frequency performance into the GHz range.

GSM RFI Attenuation in Audio & Analog

GSM handsets transmit in the 850 and 1850 MHz bands using a TDMA pulse rate of 217Hz. These signals cause the GSM buzz heard in a wide range of audio products from headphones to concert hall PA systems or “silent” signal errors created in medical, industrial process control, and security applications. Testing was conducted where an 840MHz GSM handset signal was delivered to the inputs of three different amplifier test circuit configurations shown below whose outputs were measured on a HF spectrum analyzer.

- 1) No input filter, 2 discrete MLC 100nF power bypass caps.
 - 2) 2 discrete MLC 1nF input filter, 2 discrete MLC 100nF power bypass caps.
 - 3) A single X2Y 1nF input filter, a single X2Y 100nF power bypass cap.
- X2Y configuration provided a nearly flat response above the ambient and up to 10 dB improved rejection than the conventional MLCC configuration.

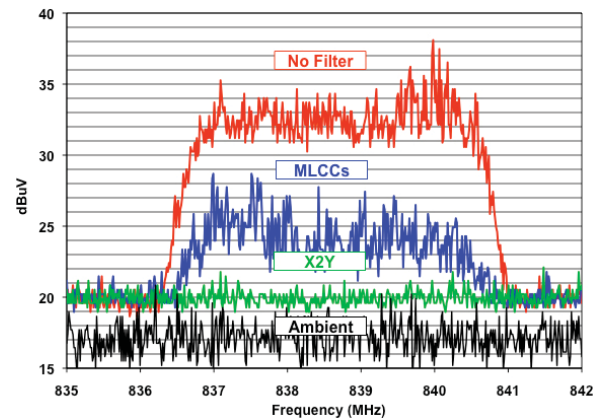

Amplifier Input Filter Example

In this example, a single Johanson X2Y® component was used to filter noise at the input of a DC instrumentation amplifier. This reduced component count by 3-to-1 and costs by over 70% vs. conventional filter components that included 1% film Y-capacitors.

Parameter	X2Y® 10nF	Discrete 10nF, 2 @ 220 pF	Comments
DC offset shift	< 0.1 μ V	< 0.1 μ V	Referred to input
Common mode rejection	91 dB	92 dB	

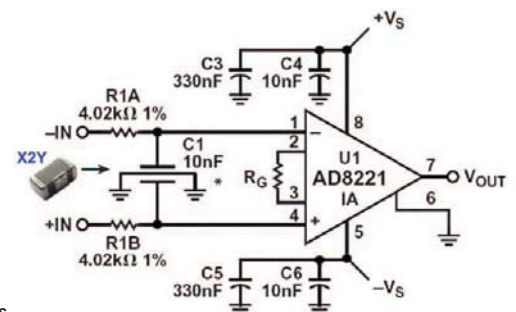

Source: Analog Devices, “A Designer’s Guide to Instrumentation Amplifiers (2nd Edition)” by Charles Kitchin and Lew Counts

Common Mode Choke Replacement

- Superior High Frequency Emissions Reduction
- Smaller Sizes, Lighter Weight
- No Current Limitation
- Vibration Resistant
- No Saturation Concerns

See our website for a detailed application note with component test comparisons and circuit emissions measurements.

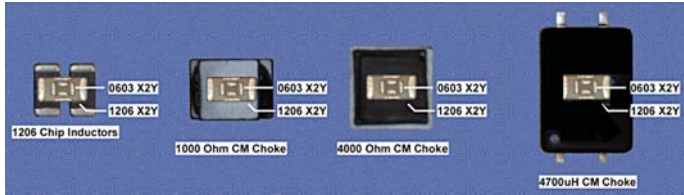

Measured Common Mode Rejection

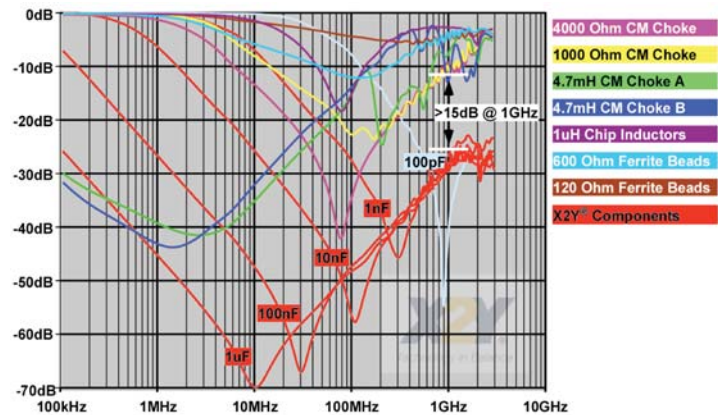

Parallel Capacitor Solution

A common design practice is to parallel decade capacitance values to extend the high frequency performance of the filter network. This causes an unintended and often over-looked effect of anti-resonant peaks in the filter networks combined impedance. X2Y's very low mounted inductance allows designers to use a single, higher value part and completely avoid the anti-resonance problem. The impedance graph on right shows the combined mounted impedance of a 1nF, 10nF & 100nF 0402 MLC in parallel in RED. The MLC networks anti-resonance peaks are nearly 10 times the desired impedance. A 100nF and 47nF X2Y are plotted in BLUE and GREEN. (The total capacitance of X2Y (Circuit 2) is twice the value, or 200nF and 98nF in this example.) The single X2Y is clearly superior to the three paralleled MLCs.

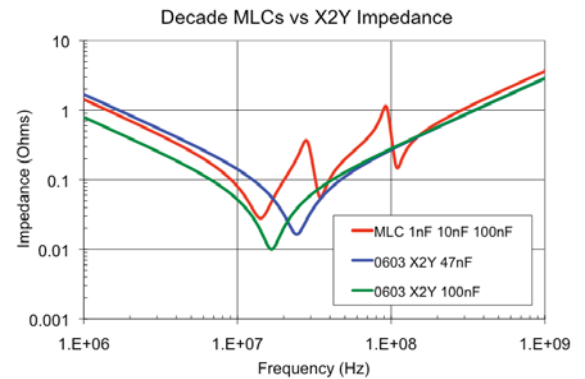

X2Y High Performance Power Bypass - Improve Performance, Reduce Space & Vias

Actual measured performance of two high performance SerDes FPGA designs demonstrate how a 13 component X2Y bypass network significantly out performs a 38 component MLC network. For more information see http://johansondielectrics.com/pdfs/JDI_X2Y_STXII.pdf

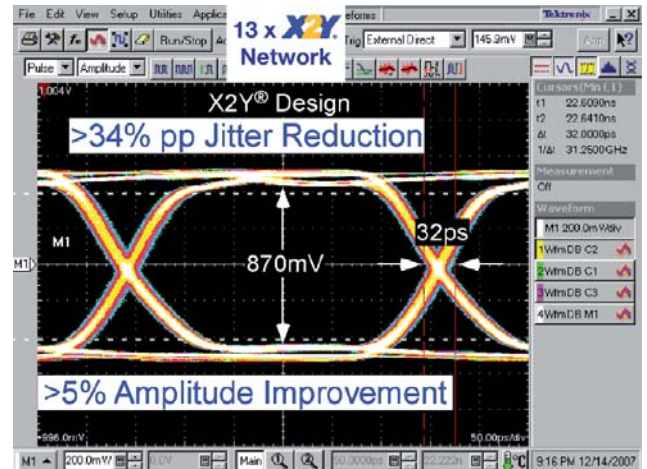
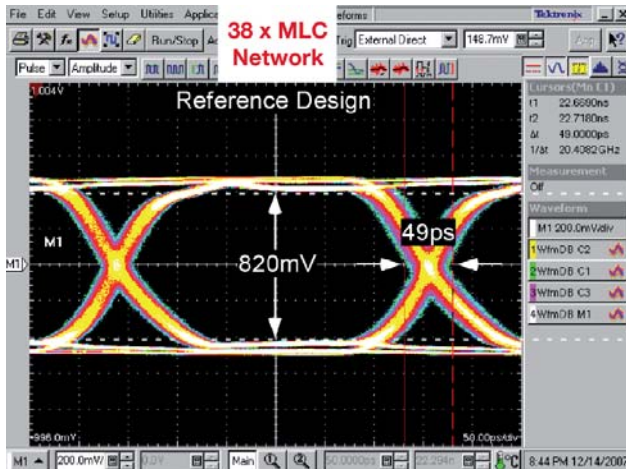
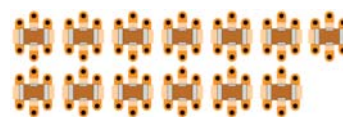
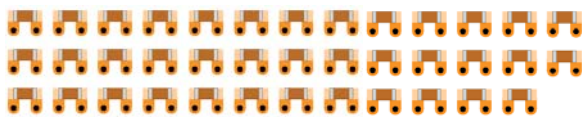

LOW INDUCTANCE CHIP CAPACITORS (LICC)



LICC capacitors are specially designed to exhibit lower inductance by altering the aspect ratio of the terminations. The smaller current loop length results in Equivalent Series Inductance (ESL) that is typically 60% lower than standard MLCs of the same size. This ESL improvement is extremely advantageous in the high frequency power decoupling of high speed digital MPU, FPGA, DSP, etc..

FEATURES

- Low Inductance
- High Series Resonant Frequency
- RoHS Compliant
- Sn-Pb and Polyterm® Termination Options
- Surface Mount
- Small Size

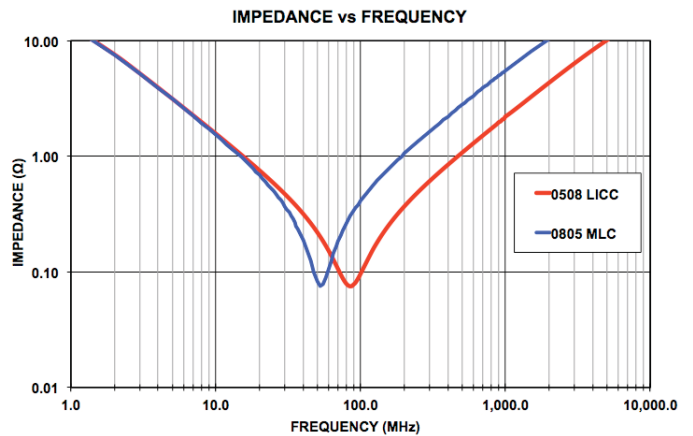
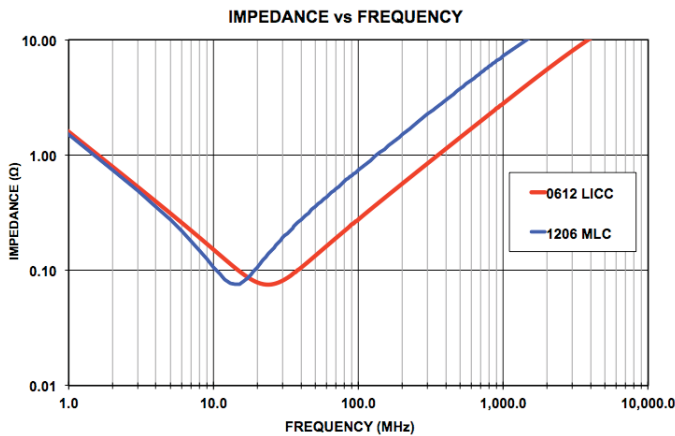
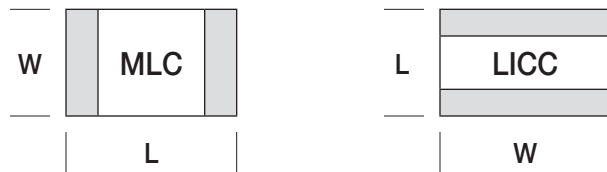

CASE SIZE

AVAILABLE CAPACITANCE

Case Size	Dimensions		Dielectric	Available Capacitance											
	Inches	(mm)		10nF	22nF	47nF	0.10µF	0.22µF	0.47µF	1.00µF	2.2 µF	4.7µF	10µF		
0306 B14	L .032 ±.008	(0.81 ±.20)	X7R	25V	25V	25V	16V	6.3V							
	W .063 ±.008	(1.60 ±.20)	X5R				10V	10V	6.3V	6.3V	6.3V				
0508 B15	L .050 ±.010	(1.27 ±.25)	X7R	50V	50V	25V	25V	16V	6.3V	6.3V					
	W .080 ±.010	(2.03 ±.25)	X5R						10V	10V	6.3V				
0612 B18	L .062 ±.010	(1.57 ±.25)	X7R	50V	50V	50V	50V	25V	16V	6.3V					
	W .125 ±.010	(3.17 ±.25)	X5R							10V	10V	6.3V	6.3V		

Please visit our website for additional product details and ordering information



CHIP FILTER / FEED-THRU CAPACITORS



Our Feed-Thru Capacitors provide excellent EMI, I/O & Power Line filtering exhibiting much lower inductance than standard SMT capacitors which results in broader frequency response. These are Precious Metal Electrode (PME) products with higher current ratings than comparable Base Metal Electrode (BME) parts.

FEATURES

- 1 Amp Current Rating
- Low Inductance, High SRF
- Surface Mount Non-polarized
- Sn-Pb and Polyterm[®] Termination Options

APPLICATIONS

- DC Power Line EMI Filter
- RF Immunity Filter
- RF Amplifier Gain Filter

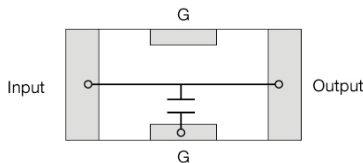

AVAILABLE CAPACITANCE

CASE SIZE			VDC	CAPACITANCE												
EIA / JDI	Inches	(mm)		22pF	47pF	100pF	220pF	470pF	1.0nF	2.2nF	4.7nF	10nF	22nF	47nF	100nF	220nF
0603 F14	L	.064 ± .005	(1.60 ± 0.20)	50	■	■	■									
	W	.035 ± .005	(0.81 ± 0.20)													
	T	.026 Max.	(0.66)													
	EB	.009 ± .004	(0.23 ± 0.10)	25					■	■	■	■	■	■	■	■
	CB	.018 ± .004	(0.46 ± 0.10)													
0805 F15	L	.080 ± .080	(2.03 ± 0.25)	100	■	■	■	■								
	W	.050 ± .080	(1.27 ± 0.25)													
	T	.040 Max.	(1.02)													
	EB	.009 ± .004	(0.23 ± 0.10)	50					■	■	■	■	■	■	■	■
	CB	.020 ± .005	(0.56 ± 0.12)													
1206 F18	L	.124 ± .010	(3.15 ± 0.25)	100	■	■	■	■								
	W	.063 ± .010	(1.60 ± 0.25)													
	T	.050 Max.	(1.27)													
	EB	.009 ± .004	(0.23 ± 0.10)	50							■	■	■	■	■	■
	CB	.040 ± .005	(1.02 ± 0.13)													

Please visit our website for additional product details and ordering information



HIGH VOLTAGE AC POWER CERAMIC CAPACITORS



This capacitor series was developed for applications requiring AC power handling. Because ceramic chips have an MSL (moisture sensitivity level) of 1.0, they exhibit far better lead-free solder reflow performance than competing FILM caps. This series is also available with Polyterm® flexible terminations which increases their resistance to cracking from excessive PCB flexure.

APPLICATIONS

- Film Cap Replacement
- Florescent and HID Lighting Ballasts
- Industrial Controls • Networking

TYPICAL POWER RATINGS VS CHIP SIZE

EIA Size	JDI Size	Rated Power
1206	R18	0.08 W
1210	S41	0.20 W
1812	S43	0.40 W

TYPICAL RIPPLE CURRENT 1KV 1812 NPO

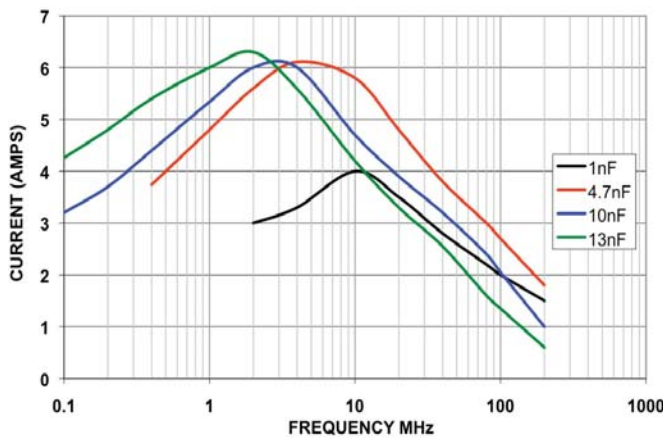

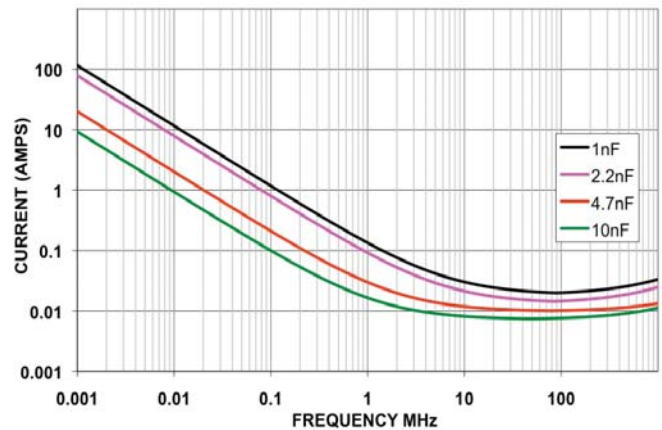

TYPICAL ESR 1KV 1812 NPO



CASE SIZE

RATED VOLTAGE

AVAILABLE CAPACITANCE

	CASE SIZE		RATED VOLTAGE		AVAILABLE CAPACITANCE			
	Inches	(mm)	DC	AC	NPO Dielectric		X7R Dielectric	
					Minimum	Maximum	Minimum	Maximum
R18/1206 	L	.125 ±.010 (3.17 ±.25)	250 VDC	141 Vrms	-	-	1000 pF	0.068 µF
	W	.062 ±.010 (1.57 ±.25)	500 VDC	283 Vrms	10 pF	1500 pF	1000 pF	0.027 µF
	T	.067 Max. (1.70)	630 VDC	356 Vrms	10 pF	1200 pF	1000 pF	0.010 µF
	E/B	.020 ±.010 (0.51 ±.25)	1000 VDC	566 Vrms	10 pF	1000 pF	100 pF	5600 pF
S41/1210 	L	.125 ±.010 (3.18 ±.25)	250 VDC	141 Vrms	-	-	1000 pF	0.120 µF
	W	.095 ±.010 (2.41 ±.25)	500 VDC	283 Vrms	10 pF	3900 pF	1000 pF	0.047 µF
	T	.080 Max. (2.03)	630 VDC	356 Vrms	10 pF	2700 pF	1000 pF	0.027 µF
	E/B	.020 ±.010 (0.51 ±.25)	1000 VDC	566 Vrms	10 pF	1800 pF	100 pF	0.010 µF
S43/1812 	L	.180 ±.010 (4.57 ±.25)	250 VDC	141 Vrms	-	-	0.010 µF	0.220 µF
	W	.125 ±.010 (3.17 ±.25)	500 VDC	283 Vrms	100 pF	8200 pF	1000 pF	0.150 µF
	T	.110 Max. (2.80)	630 VDC	356 Vrms	100 pF	6800 pF	1000 pF	0.100 µF
	E/B	.025 ±.015 (0.64 ±.38)	1000 VDC	566 Vrms	10 pF	5600 pF	1000 pF	0.022 µF

Please visit our website for additional product details and ordering information





Johanson's high temperature MLCC series exhibit stable performance across an extended operating temperature range of -55°C to +200°C. Both Class I and Class II parts are available with DC voltage ratings of 50, 100 and 200V satisfying a wide range of demanding applications.

FEATURES

- Stable 200°C Operation
- Compact SMD Chip
- Polyterm® Termination Option
- Sn-Pb Termination Option

APPLICATIONS

- Deep Hole Drilling Electronics
- High Temperature Modules
- Industrial Equipment
- Automotive • Avionics

ELECTRICAL CHARACTERISTICS

	NPO	X7R
OPERATING RANGE:	-55 to +200°C	-55 to +200°C
TEMP. COEFFICIENT:	0±30ppm/°C	+15% -45%
DISSIPATION FACTOR:	0.001 (0.1%) max.	0.020 (2.0%) max.
AGING RATE:	None	<1.0% per decade
INSULATION RESISTANCE:	25°C IR >100GΩ or 1000 ΩF whichever 200°C IR >10 ΩF or 100 ΩF is less	
WITHSTANDING VOLTAGE:	2.5 X WVDC for ratings ≤ 200 VDC 1.5 X WVDC for ratings 201-500 VDC	
TEST CONDITIONS:	C > 100 pF; 1kHz ±50Hz; 1.0±0.2 VRMS C ≤ 100 pF; 1Mhz ±50kHz; 1.0±0.2 VRMS	

TEMPERATURE - VOLTAGE COEFFICIENT

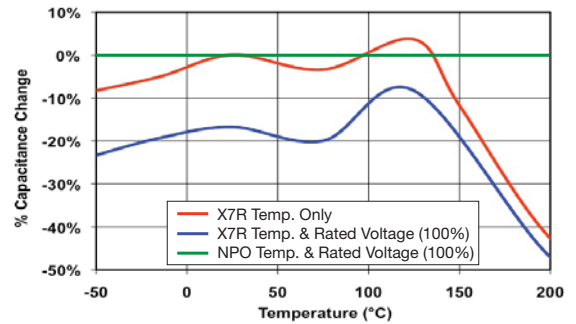

CASE SIZE	Inches		(mm)		Rated Voltage	NPO Dielectric		X7R Dielectric	
	Minimum	Maximum	Minimum	Maximum		Minimum	Maximum	Minimum	Maximum
■ T14/0603	L	.063 ±.008	(1.60 ±.20)		50 VDC	10 pF	330 pF	100 pF	0.010 μF
	W	.032 ±.008	(0.81 ±.20)		100 VDC	10 pF	220 pF	100 pF	2200 pF
	T	.035 Max.	(0.89)		200 VDC	10 pF	120 pF	100 pF	5600 pF
■ T15/0805	L	.080 ±.010	(2.03 ±.25)		50 VDC	10 pF	1500 pF	1000 pF	0.033 μF
	W	.050 ±.010	(1.27 ±.25)		100 VDC	10 pF	1000 pF	1000 pF	0.010 μF
	T	.055 Max.	(1.40)		200 VDC	10 pF	680 pF	1000 pF	2200 pF
■ T18/1206	L	.125 ±.010	(3.17 ±.25)		50 VDC	10 pF	3300 pF	1000 pF	0.100 μF
	W	.062 ±.010	(1.57 ±.25)		100 VDC	1.0 pF	2200 pF	1000 pF	0.022 μF
	T	.067 Max.	(1.70)		200 VDC	1.0 pF	1500 pF	1000 pF	5600 pF
■ T41/1210	L	.125 ±.010	(3.18 ±.25)		50 VDC	10 pF	5600 pF	0.047 μF	0.220 μF
	W	.095 ±.010	(2.41 ±.25)		100 VDC	10 pF	4700 pF	0.047 μF	0.056 μF
	T	.090 Max.	(2.03)		200 VDC	10 pF	3300 pF	0.047 μF	0.015 μF
■ T43/1812	L	.175 ±.010	(4.45 ±.25)		50 VDC	1000 pF	0.012 μF	0.047 μF	0.470 μF
	W	.125 ±.010	(3.17 ±.25)		100 VDC	1000 pF	0.010 μF	0.047 μF	0.180 μF
	T	.110 Max.	(2.80)		200 VDC	1000 pF	8200 pF	0.047 μF	0.047 μF

Please visit our website for additional product details and ordering information



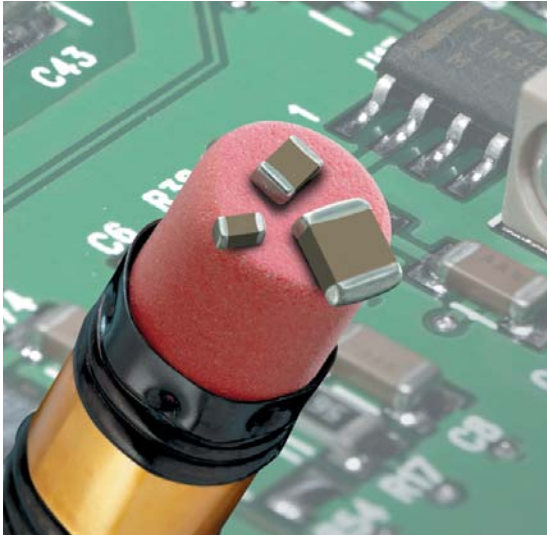

TANCERAM® chip capacitors can replace tantalum capacitors in many applications and offer several key advantages over traditional tantalums. Because Tanceram® capacitors exhibit extremely low ESR, equivalent circuit performance can often be achieved using considerably lower capacitance values. Low DC leakage reduces current drain, extending the battery life of portable products. Tancerams® high DC breakdown voltage ratings offer improved reliability and eliminate large voltage de-rating common when designing with tantalums.

ADVANTAGES

- Low ESR
- Higher Surge Voltage
- Reduced CHIP Size
- Higher Insulation Resistance
- Low DC Leakage
- Non-polarized Devices
- Improved Reliability
- Higher Ripple Current

APPLICATIONS

- Switching Power Supply Smoothing (Input/Output)
- DC/DC Converter Smoothing (Input/Output)
- Backlighting Inverters
- General Digital Circuits

Typical ESR Comparison

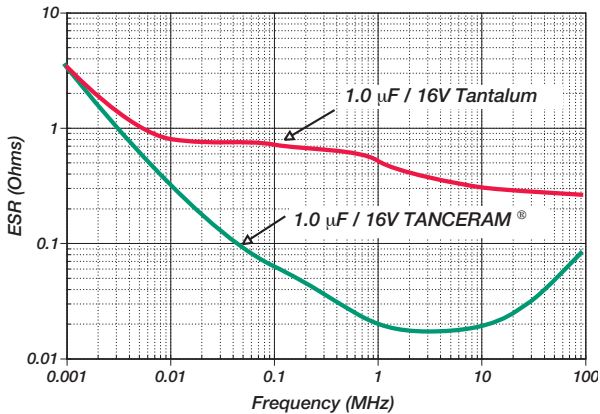

Typical Breakdown Voltage Comparison

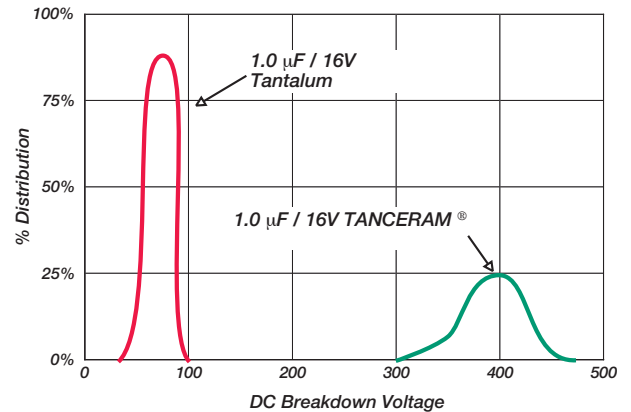

HOW TO ORDER TANCERAM®

Part number written: 100R15X106MV4E

100	R15	X	106	M	V	4	E
VOLTAGE	SIZE	DIELECTRIC	CAPACITANCE	TOLERANCE	TERMINATION	MARKING	PACKING
6R3 = 6.3 V 100 = 10 V 160 = 16 V 250 = 25 V 500 = 50 V 101 = 100 V	See Chart	W = X7R X = X5R	1st two digits are significant; third digit denotes number of zeros. 105 = 1.00 µF 476 = 4.70 µF 107 = 10.0 µF	K = ±10% M = ±20%	V = Nickel Barrier with 100% Tin Plating (Matte) T = SnPb* (*available on select parts)	4 = Unmarked	Code Type Reel E Plastic 7" T Paper 7" Tape specifications conform to EIA RS481



CASE SIZE

CAPACITANCE SELECTION

EIA / JDI	Inches	(mm)	VDC	1.0 μF	2.2 μF	3.3 μF	4.7 μF	10 μF	22 μF	47 μF	100 μF
0402 R07	L	.040 ±.004	(1.02 ±.10)								
	W	.020 ±.004	(0.51 ±.10)								
	T	.025 Max.	(0.64)								
	EB	.008 ±.004	(0.20±.10)								
0603 R14	L	.063 ±.008	(1.60 ±.20)								
	W	.032 ±.008	(0.81 ±.20)								
	T	.035 Max.	(0.89)								
	EB	.010±.005	(.25±.13)								
0805 R15	L	.080 ±.010	(2.03 ±.25)								
	W	.050 ±.010	(1.27 ±.25)								
	T	.060 Max.	(1.52)								
	EB	.020±.010	(0.51±.25)								
1206 R18	L	.125 ±.010	(3.17 ±.25)								
	W	.062 ±.010	(1.57 ±.25)								
	T	.070 Max.	(1.78)								
	EB	.020 +.015-.010	(0.51+ .38-.25)								
				100							
				50							
1210 S41	L	.125 ±.010	(3.18 ±.25)								
	W	.095 ±.010	(2.41 ±.25)								
	T	.110 Max.	(2.8)								
	EB	.020 +.015-.010	(0.51+ .38-.25)								
				100							
				50							
1812 S43	L	.175 ±.010	(4.45 ±.25)								
	W	.125 ±.010	(3.17 ±.25)								
	T	.140 Max.	(3.55)								
	EB	.035 ±.020	(0.89 ±0.51)								
				100							
				50							

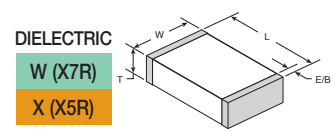

W	X	W	X	W	X	W	X	W	X	W	X	W	X	W	X
---	---	---	---	---	---	---	---	---	---	---	---	---	---	---	---

ELECTRICAL CHARACTERISTICS

Dielectric:	X7R	X5R
Temperature Coefficient:	±15% (-55 to +125°C)	±15% (-55 to +85°C)
Dissipation Factor:	For ≥ 50 VDC: 5% max. For ≤ 25 VDC: 10% max.	For ≥ 50 VDC: 5% max. For ≤ 25 VDC: 10% max.
Insulation Resistance (Min. @ 25°C, Wvdc)	100 ΩF or 10 GΩ, whichever is less	
Dielectric Strength:	2.5 X WVDC, 25°C, 50mA max.	
Test Conditions:	Capacitance values ≤ 22 μF: 1.0kHz±50Hz @ 1.0±0.2 Vrms Capacitance values > 22 μF: 120Hz±10Hz @ 0.5V±0.1 Vrms	
Other:	See page 35 for additional dielectric specifications.	

SURFACE MOUNT MLCCs 10 - 200 VDC

CASE SIZE			Voltage	AVAILABLE CAPACITANCE CODE																									
JDI	Inches	mm		0R5	XRX	100	120	150	180	220	270	330	390	470	560	680	820	101	121	151	181	221	271	331	391	471	561	681	821
R05 L .024 ±.001 W .012 ±.001 T .012 ±.001 EB .006 ±.002	0201	(0603)	25V	█																									
			16V												█														
			10V																			█							
R07 L .040 ±.004 W .020 ±.004 T .025 Max. EB .008 ±.004	0402	(1005)	50V	█											█														
			25V	█											█														
			16V																										
			10V																										
R14 L .063 ±.008 W .032 ±.008 T .035 Max. EB .010±.005	0603	(1608)	200V	█																									
			100V	█																									
			50V	█																									
			25V	█																									
			16V	█																									
R15 L .080 ±.010 W .050 ±.010 T .050 Max. EB .020±.010	0805	(2012)	200V	█																									
			100V	█																									
			50V	█																									
			25V	█																									
			16V	█																									
R18 L .125 ±.010 W .062 ±.010 T .050 Max. EB .020 ±.010	1206	(3216)	200V	█																									
			100V	█																									
			50V	█																									
			25V	█																									
			16V	█																									
S41 L .125 ±.010 W .095 ±.010 T .065 Max. EB .020 ±.010	1210	(3224)	200V	█																									
			100V	█																									
			50V	█																									
			25V	█																									
			16V	█																									
S43 L .175 ±.010 W .125 ±.010 T .085 Max. EB .025 ±.015	1812	(4532)	200V	█																									
			100V	█																									
			50V	█																									
			25V	█																									
			16V	█																									

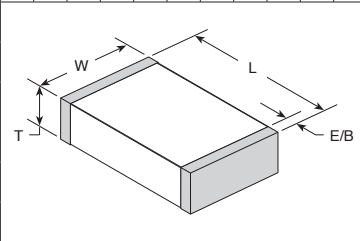

STACKED SMPS CERAMIC CAPACITORS

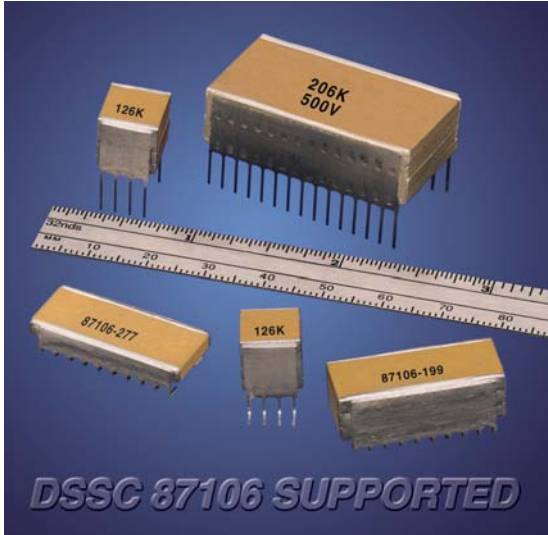

Switch-Mode ceramic capacitors feature large capacitance values and exhibit low ESR (equivalent series resistance) and low ESL (equivalent series inductance) making them well suited for high power and high frequency applications where tantalum or aluminum electrolytic capacitors may not be suitable. The P-Series feature mechanical and pin-out configurations per DSCC 87106 and 88011 drawings while the E-Series feature mechanical and pin-out configurations more common in European design applications.

KEY FEATURES

- P-Series Approved to DSCC Drawings 87106 & 88011 MIL-PRF-49470
- **New T-Series 200°C** for downhole tools and aircraft engine control applications.
- E-Series Common European Lead Styles available to MIL-PRF-49470 requirements.
- NPO & X7R Dielectrics, 50 to 500 VDC Ratings
- Low ESR / Low ESL, Ideal for SMPS Filtering Applications
- Custom Sizes, Voltages, and Values Available

CASE SIZE

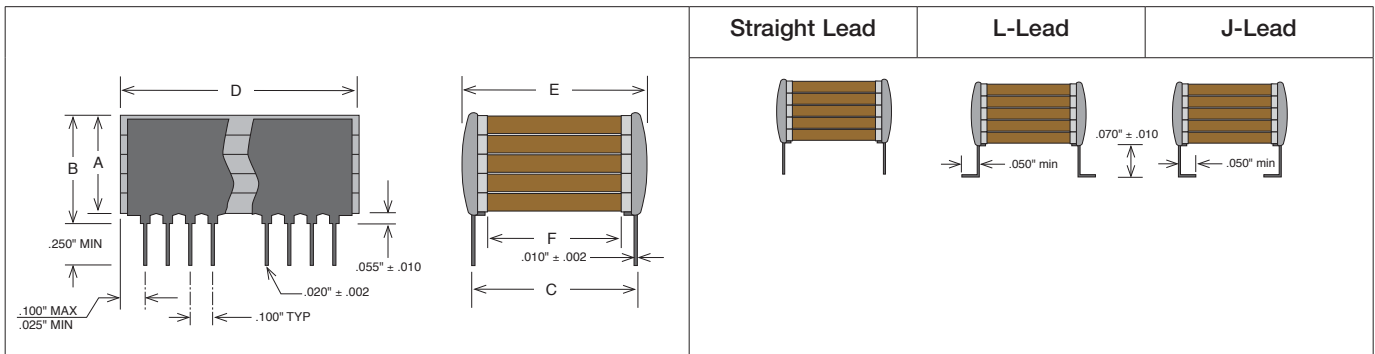

HOW TO ORDER STACKED SMPS

Part number written: 201P03W275KJ4H

201	P03	W	275	K	J	4	H
VOLTAGE	SIZE	DIELECTRIC	CAPACITANCE	TOLERANCE	TERMINATION	MARKING	PACKING
500 = 50 V 101 = 100 V 201 = 200 V 501 = 500 V	See Chart	N = NPO B = BX W = X7R	1st two digits are significant; third digit denotes number of zeros. 101 = 100 pF 102 = 1000 pF 103 = 0.01 μF 105 = 1.00 μF	J = ±5% K = ±10% L = ±15% M = ±20% N = ±30% Z = +80% -20% P = +100% -0%	J = "J" Leads (formed in) L = "L" Leads (formed out) M = "L" Leads with reduced height of .045" +/- .010" N = Straight Lead	4 = Standard 3 = Specified	T = Tape and Reel H = High Reliability testing per customer requirements S = Special Part



STACKED SMPS CERAMIC CAPACITORS

P-SERIES DSCC STYLE X7R CAPACITANCE / VOLTAGE SELECTION

CASE SIZE	NO. CHIPS	LEADS /SIDE	Mechanical Size Range (In.)			X7R Max Capacitance (µF)			
			Length (D)	Width (E)	Tmax (B)	50V	100V	200V	500V
P05	1	3	0.275	0.300	.185	3.0	2.2	1.0	0.50
P55	5				.715	15	11	5.0	2.5
P04	1	4	0.425	0.440	.185	9.0	6.5	3.0	1.5
P54	5				.715	45	32	15	7.5
P03	1	10	1.075	0.500	.185	28	20	9.5	4.7
P53	5				.715	140	100	47	23
P01	1	20	2.075	0.500	.185	50	40	19	9.4
P51	5				.715	250	200	95	46
P02	1	15	1.535	0.870	.185	75	55	25	14
P52	5				.715	370	270	125	70
P06	1	20	2.075	1.350	.185	160	110	50	25
P56	5				.715	800	550	250	125

Partial product line listing, please refer to our website for complete offering including NPO & BX capacitance ranges. .

NEW 200°C T-SERIES CAPACITANCE / VOLTAGE SELECTION

CASE SIZE	NO. CHIPS	LEADS /SIDE	Mechanical Size Range (In.)			Max Capacitance (µF)		
			Length (D)	Width (E)	Tmax (B)	50V	100V	200V
T05	1	3	0.275	0.300	.185	1.20	0.68	0.33
T55	5				.715	5.60	3.30	1.50
T04	1	4	0.425	0.440	.185	2.70	1.50	0.82
T54	5				.715	15.0	8.20	3.90
T03	1	10	1.075	0.500	.185	10.0	5.60	2.70
T53	5				.715	47.0	27.0	12.0

Partial product line listing, please refer to our website for complete offering including NPO capacitance ranges.

E-SERIES EUROPEAN STYLE X7R CAPACITANCE / VOLTAGE SELECTION

CASE SIZE	NO. CHIPS	LEADS /SIDE	Mechanical Size Range (mm)			X7R Max Capacitance (µF)			
			Length (D)	Width (E)	Tmax (B)	50V	100V	200V	500V
E24	1	3	8.7	9.2	3.8	5.0	4.0	2.5	1.0
E54	4				14.8	20	16	10	4.0
E26	1	5	13.6	14.9	3.	16	12	7.5	3.3
E56	4				14.8	64	48	30	13
E21	1	6	16.6	21.6	3.8	30	22	14	6.0
E51	4				14.8	120	88	56	24
E28	1	14	38.2	12.0	3.8	35	25	16	7.0
E58	4				14.8	140	100	64	28
E29	1	14	40.6	24.0	3.8	75	50	35	16
E59	4				14.8	300	200	140	64

Partial product line listing, please refer to our website for complete offering including NPO & BX capacitance ranges.



MINI-SWITCH MODE® CAPACITORS

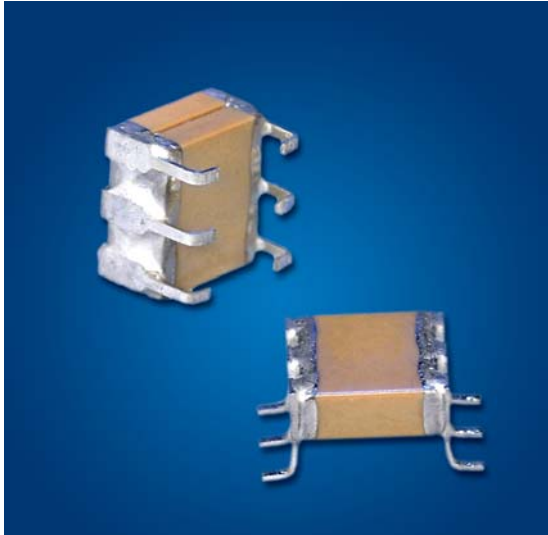

JDI's Mini-Switch Mode® ceramic capacitors combine the advantages of high capacitance found in tantalum capacitors with very low ESR performance of ceramic capacitors. The “J” and “L” lead configurations replace 1825 and 2225 SMT chips to provide stress relief and prevent cracking due to thermal cycling or mechanical board flexing. Another plus of the J-lead style is that this configuration allows use of the same solder lands as the SMT chips. See the Switch-Mode section for larger values. See also the Technical Notes on soldering and handling and suggested solder lands.

FEATURES

- High Capacitance, Small Size
- Low ESR/ESL
- Leadframe reduces thermal & mechanical stress due to board flexure and TCE mismatch

APPLICATIONS

- DC-DC Converters
- Power Supply Input & Output Filters

CAPACITANCE SELECTION

SIZE CODE	EIA CHIP SIZE	NPO Max Capacitance (uF)					X7R Max Capacitance (uF)				
		25V	50V	100V	200V	500V	25V	50V	100V	200V	500V
P09	1825	0.056	0.047	0.039	0.027	0.018	1.5	1.2	0.75	0.56	0.27
P29	1825	0.11	0.094	0.078	0.054	0.036	3.0	2.4	1.5	1.1	0.54
P39	1825	0.16	0.14	0.11	0.081	0.054	4.5	3.6	2.2	1.6	0.81
P49	1825	0.22	0.18	0.15	0.10	0.07	6.0	4.8	3.0	2.2	1.0
P08	2225	0.068	0.056	0.047	0.033	0.027	2.7	2.2	1.5	1.2	0.39
P28	2225	0.13	0.11	0.094	0.066	0.054	5.4	4.4	3.0	2.4	0.78
P38	2225	0.20	0.16	0.14	0.10	0.081	8.1	6.6	4.5	3.6	1.1
P48	2225	0.27	0.22	0.18	0.13	0.10	10	8.8	6.0	4.8	1.5

MINI-SWITCH MODE® CAPACITORS

CASE SIZE

Dimensions Applicable to all sizes:																		
	In.	mm																
h ± .010	.070	1.78																
c Typ.	.100	2.54																
p ± .015	.065	1.65																
Dimensions Applicable to specific sizes:			P08		P09		P28		P29		P38		P39		P48		P49	
	In.	mm	In.	mm	In.	mm	In.	mm	In.	mm	In.	mm	In.	mm	In.	mm	In.	mm
L max	.280	7.11	0.24	6.1	0.28	7.11	0.24	6.1	0.28	7.11	0.24	6.1	0.28	7.11	0.24	6.1	0.28	7.11
W max	.270	6.86	0.27	6.86	0.27	6.86	0.27	6.86	0.27	6.86	0.27	6.86	0.27	6.86	0.27	6.86	0.27	6.86
T max	.095	2.41	0.095	2.41	0.19	4.83	0.19	4.83	0.285	7.24	0.285	7.24	0.285	7.24	0.285	7.24	0.285	7.24

Note: J-Lead and L-Lead options are available on all sizes above

ELECTRICAL CHARACTERISTICS

Dielectric:	NPO	X7R
Temperature Coefficient:	0 ±30ppm/°C (-55 to +125°C)	±15% (-55 to +125°C)
Dissipation Factor:	0.1% max.	2.5% max.
Aging	None	-2.5% per decade hour
Insulation Resistance (Min. @ 25°C, WVDC)	1000 ΩF or 100 GΩ, whichever is less	500 ΩF or 50 GΩ, whichever is less
Dielectric Strength:	For 500V Ratings: 750VDC, 25°C, 50mA max For 200V Ratings: 2xWVDC, 25°C, 50mA max For 25-100V Ratings: 2.5xWVDC, 25°C, 50mA max	
Test Conditions:	1kHz ±50Hz; 1.0±0.2 VRMS	
Other:	See page 35 for additional dielectric specifications.	

HOW TO ORDER - MINI-SWITCH MODE®

Part number written: 500P28W395KJ4U

500	P28	W	395	K	J	4	U
VOLTAGE	SIZE	DIELECTRIC	CAPACITANCE	TOLERANCE	TERMINATION	MARKING	PACKING
250 = 25 V 500 = 50 V 101 = 100 V 201 = 200 V 501 = 500 V	See Chart	N = NPO W = X7R	1st two digits are significant; third digit denotes number of zeros. 103 = 0.01 µF 105 = 1.0 µF 106 = 10 µF	J = ±5% K = ±10% M = ±20% Z = +80% -20%	J = "J" Leads (formed in) L = "L" Leads (formed out)	4 = Unmarked	U = Tape and Reel 16mm, 13" Reel NONE = Bulk pack H = High Reliability testing per customer requirements S = Special Part





Johanson Dielectrics Maxi-cap™ Series of ultra high capacitance stacked ceramic capacitors exhibit very low ESR/ESL for high current handling capability in small sizes. The J lead configuration provides good mechanical and thermal stress performance and is similar to the leadframe used in high-rel applications. In addition the J-lead configuration allows direct substitution of SMT chip footprints. The standard range is offered in 1 and 2 chip horizontal stacks giving potential board space savings.

FEATURES

- High Capacitance, Small Size
- Low ESR/ESL
- Leadframe reduces thermal & mechanical stress due to board flexure and TCE mismatch
- Green / ROHS Compliant

APPLICATIONS

- DC-DC Converters
- Power Supply Input & Output Filters

AVAILABLE CAPACITANCE (X7R DIELECTRIC)

RATED DC VOLTAGE	P0A	P07	P2A	P27
50V	4.7 μ F	10 μ F	10 μ F	22 μ F
100V	2.2 μ F	4.7 μ F	4.7 μ F	10 μ F

CASE SIZE

Dimensions Applicable to specific sizes:			P0A		P07		P2A		P27					
			In.	mm	In.	mm	In.	mm	In.	mm				
L Max			0.217	5.5	0.256	6.5	0.217	5.5	0.256	6.5				
W Max			0.157	4.0	0.217	5.5	0.157	4.0	0.217	5.5				
H Max			0.118	3.0	0.118	3.0	0.236	6.0	0.236	6.0				
Dimensions Applicable to all sizes:														
h1 Max			.059	1.50										
c Typ.			.100	2.54										
p1 Typ.			.020	0.50										
p2 ± 0.02			.065	1.65										



TYPICAL APPLICATION: DC-DC Converter Input & Output Filtering

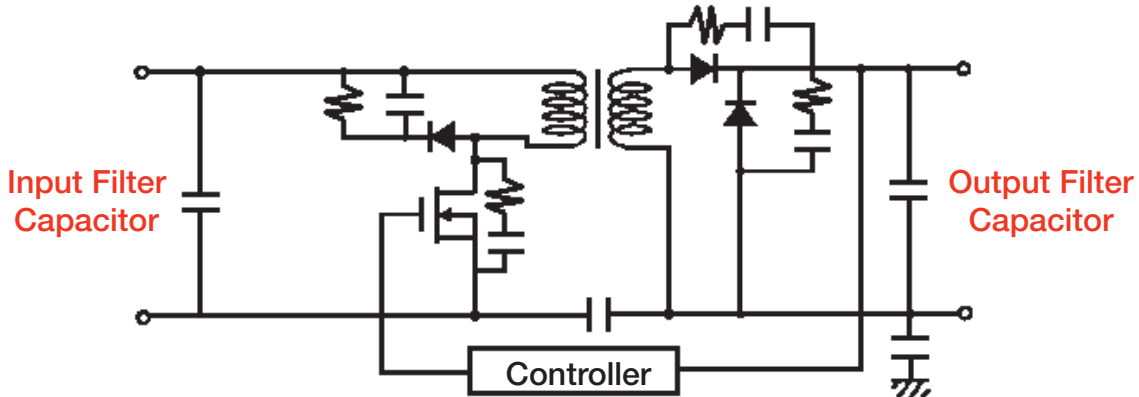

ELECTRICAL CHARACTERISTICS

OPERATING RANGE:	-55 to +125°C
TEMPERATURE COEFFICIENT:	X7R, ±15%
DISSIPATION FACTOR:	0.020 (2.0%) max.
AGING RATE:	<2.5% per decade
INSULATION RESISTANCE:	25°C IR >100GΩ or 1000 ΩF whichever is less
WITHSTANDING VOLTAGE:	2.5 X WVDC for 50 VDC 2.0 X WVDC for 100 VDC
TEST CONDITIONS:	1kHz ±50Hz; 1.0±0.2 VRMS, 25°C

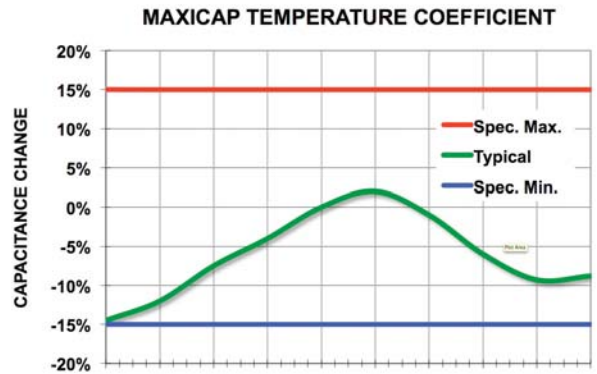

HOW TO ORDER - MAXI-CAP™

Part number written: 500P07W106MJ4U+RC

500	P07	W	106	M	J	4	U	+RC
VOLTAGE	SIZE	DIELECTRIC	CAPACITANCE	TOLERANCE	TERMINATION	MARKING	PACKING	ROHS CODE
500 = 50 V 101 = 100 V	See Chart	W = X7R	1st two digits are significant; third digit denotes number of zeros. 225 = 2.2 μF 106 = 10 uF	M = ±20%	J = "J" Leads (formed in)	4 = Unmarked	U = Embossed Tape 13" Reel per EIA RS481	+RC = RoHS Compliant



X2Y[®] SWITCH-MODE CERAMIC CAPACITORS

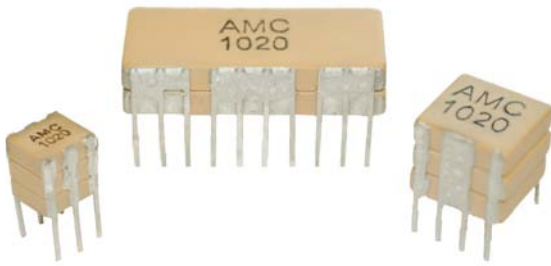

JDI's new X2Y[®] Technology Switch-Mode ceramic capacitors exhibit significantly lower ESL making them ideally suited for applications where high frequency filtering performance is critical. Lower ESL performance translates to significant size and weight reduction because lower capacitance values perform as well or better

KEY FEATURES

- Low ESR / Low ESL, Ideal for SMPS Filtering Applications
- Same Package Size as DSCC Drawings 87106 & 88011 MIL-PRF-49470
- NPO & X7R Dielectrics, 50 to 500 VDC Ratings
- Custom Sizes, Voltages, and Values Available

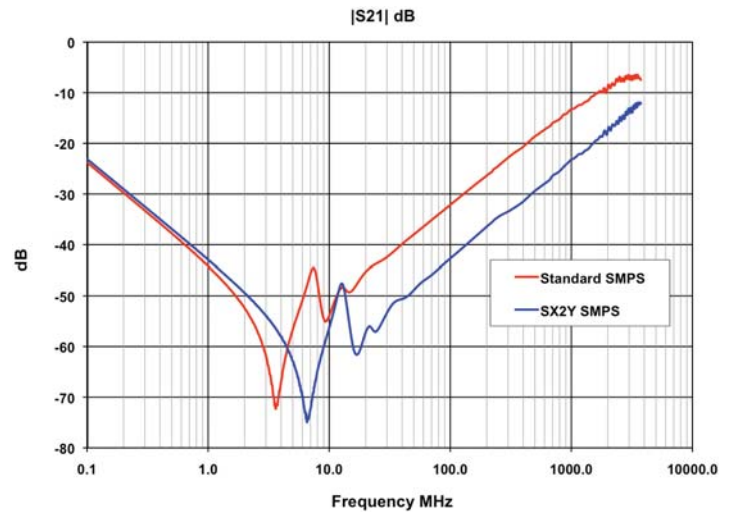
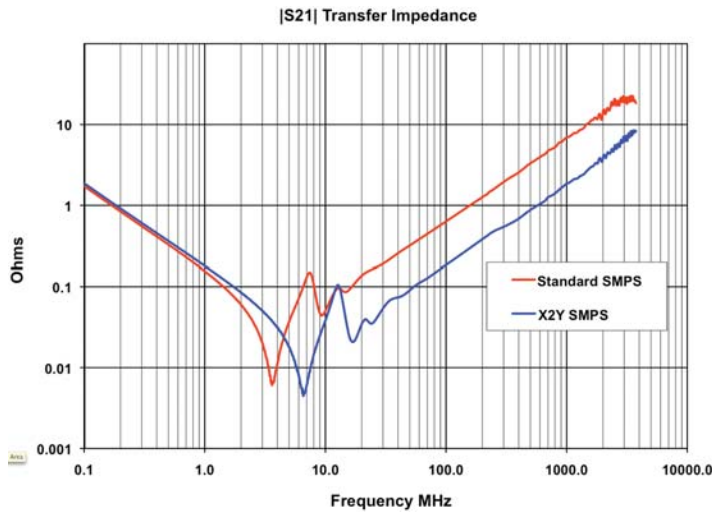

CAPACITANCE / VOLTAGE SELECTION

Rated DC Voltage	Maximum X7R Capacitance Per Case Size (µF)														
	Y05	Y25	Y35	Y45	Y55	Y04	Y24	Y34	Y44	Y54	Y03	Y23	Y33	Y43	Y53
50V	2.7	5.0	8.0	11	14	8.3	17	25	33	41	29	58	87	116	145
100V	2.0	4.0	6.0	8.0	10	6.0	12	17	24	29	21	41	62	83	104
200V	0.9	1.8	2.7	4.0	5.0	2.8	5.5	8.3	11	14	9.8	20	29	39	49
500V	0.5	0.9	1.4	1.8	2.3	1.4	2.8	4.1	5.5	6.9	4.9	9.7	14	19	24



X2Y[®] SWITCH-MODE CERAMIC CAPACITORS

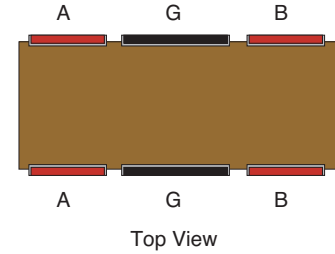
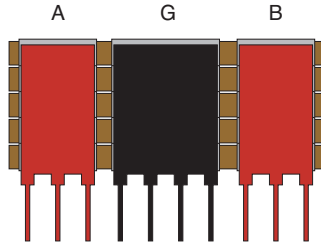
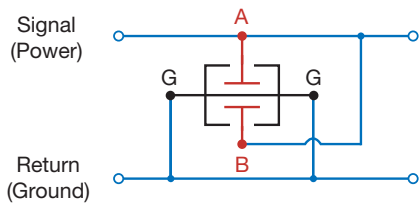

Contact the factory for additional connection options for dual signal line EMI filtering applications.

CASE SIZE

	CASE SIZES														
	Y05	Y25	Y35	Y45	Y55	Y04	Y24	Y34	Y44	Y54	Y03	Y23	Y33	Y43	Y53
A	.120	.240	.360	.480	.650	.120	.240	.360	.480	.650	.120	.240	.360	.480	.650
B	.185	.305	.425	.545	.715	.185	.305	.425	.545	.715	.185	.305	.425	.545	.715
C	.250					.400					.450				
D-	.224					.350					.950				
D+	.275					.425					1.075				
E	.300					.440					.500				
Pins	3 per side, configuration: a = 1, b = 1, g = 1					5 per side, configuration a = 1, b = 1, g = 3					10 per side, configuration a = 3, b = 3, g = 4				

All dimensions are in inches. Tolerances are maximum except: C = ±.025" D- = minimum, D+ = maximum, F = minimum

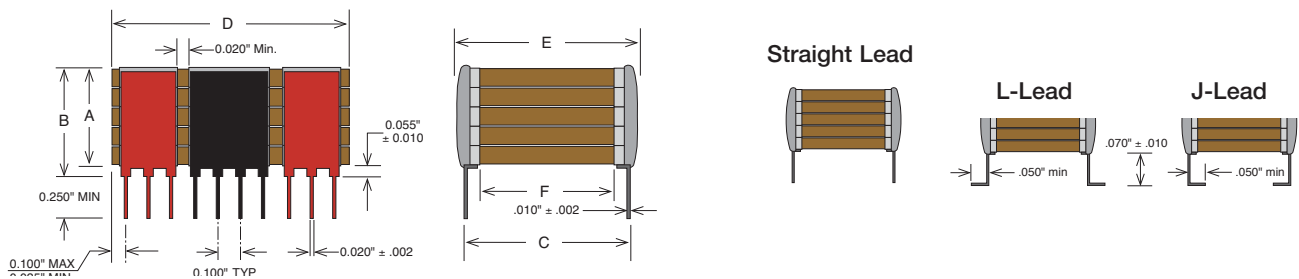

HOW TO ORDER - X2Y[®] SMPS

Part number written: 201Y03W475KJ4H

201	Y03	W	475	M	J	4	H
VOLTAGE	SIZE	DIELECTRIC	CAPACITANCE	TOLERANCE	TERMINATION	MARKING	PACKING
500 = 50 V 101 = 100 V 201 = 200 V 501 = 500 V	See Chart	W = X7R	1st two digits are significant; third digit denotes number of zeros. 104 = 0.10 μF 105 = 1.00 μF 475 = 4.70 μF	M = ±20%	J = "J" Leads (formed in) L = "L" Leads (formed out) N = Straight Lead	4 = Standard 3 = Specified	T = Tape and Reel H = High Reliability testing per customer requirements S = Special Part



SWITCH-MODE RADIAL LEADED CAPACITORS

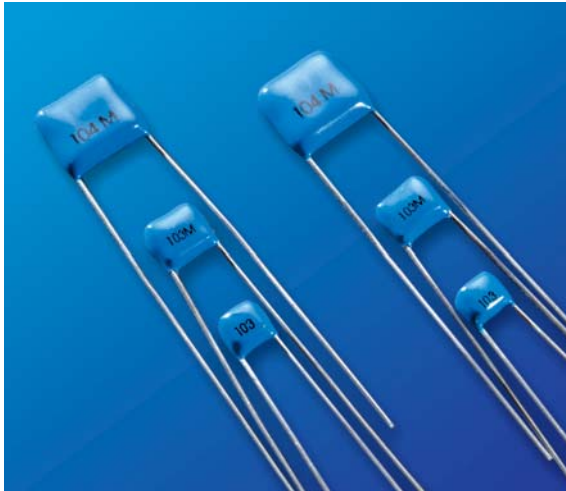





KEY FEATURES





- Rated Working Voltages from 25 to 500 VDC
- Rugged Epoxy Coating Offers Increased Protection
- Hi-Rel Screened Versions Available
- Custom Sizes, Voltages, and Values Available

ADVANTAGES

- Power Supplies
- Voltage Multipliers
- Data Isolation
- Surge Protection
- Industrial Control Circuits
- Custom Applications

CASE SIZE	In.		RATED VOLTAGE	NPO CAPACITANCE (MAX.)		X7R CAPACITANCE (MAX.)		
		(mm)						
 H03	W	.300 max.	(7.62 max.)	25 VDC	.070 μ F	703	2.00 μ F	205
	H	.300 max.	(7.62 max.)	50 VDC	.060 μ F	603	1.60 μ F	165
	T	.200 max.	(5.08 max.)	100 VDC	.050 μ F	503	1.10 μ F	115
	S	.200 nom.	(5.08 nom.)	200 VDC	.040 μ F	403	.730 μ F	734
	Ld	.020 nom.	(.510 nom.)	500 VDC	.020 μ F	203	.250 μ F	254
 H04	W	.400 max.	(10.2 max.)	25 VDC	.120 μ F	124	5.10 μ F	515
	H	.400 max.	(10.2 max.)	50 VDC	.100 μ F	104	4.10 μ F	415
	T	.200 max.	(5.08 max.)	100 VDC	.082 μ F	823	2.70 μ F	275
	S	.200 nom.	(5.08 nom.)	200 VDC	.050 μ F	503	1.80 μ F	185
	Ld	.020 nom.	(.510 nom.)	500 VDC	.030 μ F	303	.670 μ F	674
 H05	W	.500 max.	(12.7 max.)	25 VDC	.240 μ F	244	8.70 μ F	875
	H	.500 max.	(12.7 max.)	50 VDC	.200 μ F	204	7.20 μ F	725
	T	.200 max.	(5.08 max.)	100 VDC	.180 μ F	184	4.80 μ F	485
	S	.400 nom.	(10.2 nom.)	200 VDC	.110 μ F	114	3.30 μ F	335
	Ld	.025 nom.	(.635 nom.)	500 VDC	.070 μ F	703	1.10 μ F	115
 H06	W	.870 max.	(22.1 max.)	25 VDC	.750 μ F	754	22.0 μ F	226
	H	.600 max.	(15.2 max.)	50 VDC	.620 μ F	624	17.0 μ F	176
	T	.200 max.	(5.08 max.)	100 VDC	.560 μ F	564	13.0 μ F	136
	S	.790 nom.	(20.1 nom.)	200 VDC	.360 μ F	364	8.00 μ F	805
	Ld	.032 nom.	(.813 nom.)	500 VDC	.240 μ F	244	2.90 μ F	295

SWITCH-MODE RADIAL LEADED CAPACITORS

CASE SIZE	In.	(mm)	RATED VOLTAGE	NPO CAPACITANCE (MAX.)		X7R CAPACITANCE (MAX.)		
 H07	W	1.10 max.	(27.9 max.)	25 VDC	.680 μ F	684	35.0 μ F	356
	H	.600 max.	(15.2 max.)	50 VDC	.560 μ F	564	28.0 μ F	286
	T	.200 max.	(5.08 max.)	100 VDC	.470 μ F	474	19.0 μ F	196
	S	.980 nom.	(24.9 nom.)	200 VDC	.330 μ F	334	13.0 μ F	136
	Ld	.032 nom.	(.813 nom.)	500 VDC	.200 μ F	204	4.60 μ F	465
 H08	W	1.10 max.	(27.9 max.)	25 VDC	1.20 μ F	125	70.0 μ F	706
	H	.600 max.	(15.2 max.)	50 VDC	1.10 μ F	115	56.0 μ F	566
	T	.350 max.	(8.89 max.)	100 VDC	.820 μ F	824	37.0 μ F	376
	S	.980 nom.	(24.9 nom.)	200 VDC	.470 μ F	474	26.0 μ F	266
	Ld	.032 nom.	(.813 nom.)	500 VDC	.300 μ F	304	8.70 μ F	875
 H09	W	.670 max.	(17 max.)	25 VDC	.450 μ F	454	13.0 μ F	136
	H	.540 max.	(13.7 max.)	50 VDC	.360 μ F	364	10.0 μ F	106
	T	.200 max.	(5.08 max.)	100 VDC	.330 μ F	334	7.20 μ F	725
	S	.575 nom.	(14.6 nom.)	200 VDC	.240 μ F	244	5.00 μ F	505
	Ld	.025 nom.	(.635 nom.)	500 VDC	.180 μ F	184	1.70 μ F	175
 H10	W	.930 max.	(23.6 max.)	25 VDC	1.00 μ F	105	38.0 μ F	386
	H	.720 max.	(18.3 max.)	50 VDC	.900 μ F	904	30.0 μ F	306
	T	.250 max.	(6.35 max.)	100 VDC	.750 μ F	754	20.0 μ F	206
	S	.800 nom.	(20.3 nom.)	200 VDC	.470 μ F	474	14.0 μ F	146
	Ld	.032 nom.	(.813 nom.)	500 VDC	.300 μ F	304	5.80 μ F	585

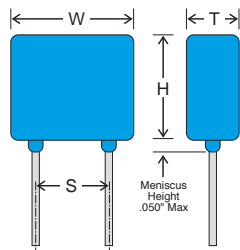

NOTE: Lead lengths are typically 1.25" for orders in bulk packaging. Leads are typically 1.00" for tape and reel packaging. Tape and reel packaging comes in 1000 piece reels.

HOW TO ORDER SWITCH-MODE RADIALS

Part number written: 201H07W105KQ4

201	H07	W	105	K	Q	4	
VOLTAGE	SIZE	DIELECTRIC	CAPACITANCE	TOLERANCE	TERMINATION	MARKING	PACKING
250 = 25 V 500 = 50 V 101 = 100 V 201 = 200 V 501 = 500 V	See Chart	N = NPO W = X7R	1st two digits are significant; third digit denotes number of zeros. 101 = 100 pF 102 = 1000 pF 103 = 0.01 μ F 105 = 1.00 μ F	J = \pm 5% K = \pm 10% M = \pm 20% Z = +80% -20%	Q = Leaded & Encapsulated	4 = Standard 3 = Specified	T = Tape and Reel H = High Rel Testing per customer requirements S = Special Part



HIGH VOLTAGE RADIAL LEADED CAPACITORS

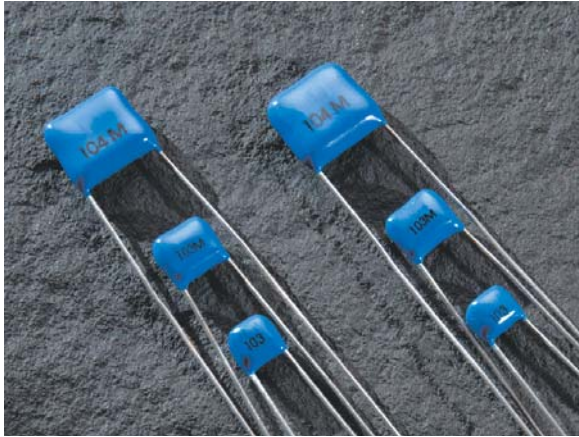





KEY FEATURES

- Rated Working Voltages from 25 to 500 VDC
- Rugged Epoxy Coating Offers Increased Protection
- Compact MLC Designs Smaller Than Film or Disc
- **NEW 200°C & 250°C** Versions Available for Oil & Geophysical Tool, Aircraft Engine Control Applications
- DSCC Drawing & Other Screened Versions Available



ADVANTAGES

- Power Supplies
- Voltage Multipliers
- Data Isolation
- Surge Protection
- Industrial Control Circuits
- Custom Applications

CASE SIZE

	In.	(mm)	RATED VOLTAGE	NPO CAPACITANCE (MAX.)		X7R CAPACITANCE (MAX.)		
 H42	W	0.250 Max	(6.35 Max)	500 VDC	4700 pF	472	.150 μ F	154
	H	0.220 Max	(5.59 Max)	1000 VDC	1500 pF	152	.055 μ F	553
	T	0.270 Max	(6.86 Max)	2000 VDC	680 pF	681	9000 pF	902
	S	0.170 \pm 0.03	(4.32 \pm 0.76)	3000 VDC	330 pF	331	2800 pF	282
	Ld	0.025 \pm 0.002	(0.64 \pm 0.05)	4000 VDC	150 pF	151	630 pF	631
				5000 VDC	100 pF	101	550 pF	531
 H47	W	0.370 Max	(9.40 Max)	500 VDC	.022 μ F	223	.480 μ F	484
	H	0.300 Max	(7.62 Max)	1000 VDC	3300 pF	332	.170 μ F	174
	T	0.270 Max	(6.86 Max)	2000 VDC	1500 pF	152	.025 μ F	253
	S	0.275 \pm 0.03	(6.99 \pm 0.76)	3000 VDC	680 pF	681	.011 μ F	113
	Ld	0.025 \pm 0.002	(0.64 \pm 0.05)	4000 VDC	330 pF	331	1800 pF	182
				5000 VDC	220 pF	221	940 pF	941
 H51	W	0.470 Max	(12.0 Max)	500 VDC	.056 μ F	563	1.20 μ F	125
	H	0.400 Max	(10.2 Max)	1000 VDC	4700 pF	472	.450 μ F	454
	T	0.320 Max	(8.13 Max)	2000 VDC	3300 pF	332	.094 μ F	943
	S	0.375 \pm 0.03	(9.53 \pm 0.76)	3000 VDC	1500 pF	152	.043 μ F	433
	Ld	0.025 \pm 0.002	(0.64 \pm 0.05)	4000 VDC	1000 pF	102	.010 μ F	103
				5000 VDC	470 pF	471	4900 pF	492
 H62	W	0.570 Max	(14.5 Max)	500 VDC	.100 μ F	104	2.20 μ F	225
	H	0.500 Max	(12.7 Max)	1000 VDC	.010 μ F	103	.804 μ F	804
	T	0.320 Max	(8.13 Max)	2000 VDC	6800 pF	682	.240 μ F	244
	S	0.475 \pm 0.03	(12.1 \pm 0.76)	3000 VDC	3300 pF	332	.073 μ F	733
	Ld	0.025 \pm 0.002	(0.64 \pm 0.05)	4000 VDC	2200 pF	222	.028 μ F	283
				5000 VDC	1000 pF	102	.013 μ F	133
 H66	W	0.670 Max	(17.0 Max)	500 VDC	.150 μ F	154	3.30 μ F	335
	H	0.600 Max	(15.2 Max)	1000 VDC	.015 μ F	153	1.20 μ F	125
	T	0.320 Max	(8.13 Max)	2000 VDC	.010 μ F	103	.440 μ F	444
	S	0.575 \pm 0.03	(14.6 \pm 0.76)	3000 VDC	4700 pF	472	.013 μ F	134
	Ld	0.025 \pm 0.002	(0.64 \pm 0.05)	4000 VDC	3300 pF	332	.041 μ F	413
				5000 VDC	2200 pF	222	.020 μ F	203

HIGH VOLTAGE RADIAL LEADED CAPACITORS

CASE SIZE	CASE SIZE		RATED VOLTAGE	NPO CAPACITANCE (MAX.)		X7R CAPACITANCE (MAX.)	
	In.	(mm)					
 H70	W	0.770 Max (19.6 Max)	500 VDC	.220 μ F	224	5.70 μ F	575
	H	0.720 Max (18.3 Max)	1000 VDC	.022 μ F	223	2.10 μ F	215
	T	0.320 Max (8.13 Max)	2000 VDC	.015 μ F	153	.620 μ F	624
	S	0.675 \pm 0.03 (17.1 \pm 0.76)	3000 VDC	6800 pF	682	.190 μ F	194
	Ld	0.025 \pm .002 (0.64 \pm 0.05)	4000 VDC	4700 pF	472	.054 μ F	543
			5000 VDC	3300 pF	332	.026 μ F	263
 H72	W	0.870 Max (22.1 Max)	500 VDC	.330 μ F	334	7.30 μ F	735
	H	0.750 Max (19.1 Max)	1000 VDC	.100 μ F	104	2.80 μ F	285
	T	0.320 Max (8.13 Max)	2000 VDC	.056 μ F	563	.800 μ F	804
	S	0.775 \pm 0.03 (19.7 \pm 0.76)	3000 VDC	.033 μ F	333	.250 μ F	254
	Ld	0.025 \pm .002 (0.64 \pm 0.05)	4000 VDC	.010 μ F	103	.080 μ F	803
			5000 VDC	6800 pF	682	.041 μ F	413
 H80	W	1.450 Max (36.8 Max)	500 VDC	.470 μ F	474	12.0 μ F	126
	H	0.720 Max (18.3 Max)	1000 VDC	.150 μ F	154	4.60 μ F	465
	T	0.320 Max (8.13 Max)	2000 VDC	.082 μ F	823	1.20 μ F	125
	S	1.375 \pm 0.03 (34.9 \pm 0.76)	3000 VDC	.047 μ F	473	.390 μ F	394
	Ld	0.025 \pm .002 (0.64 \pm 0.05)	4000 VDC	.015 μ F	153	.130 μ F	134
			5000 VDC	.010 μ F	103	.068 μ F	683

T-SERIES 200°C & 250°C

Johanson also offers two different series of high temperature radial leaded capacitors for 200°C and 250°C. These components feature rugged pre-molded cases with Hi-Temp epoxy fill. The 200°C line is offered in voltage ratings of 25V to 4KV and maximum capacitance loss of -0.5% in NPO and -45% in X7R. The 250°C line is offered in voltage ratings of 50V & 100V with maximum capacitance loss of -1.5% in NPO and -55% in X7R. Please visit our website for complete component selection & specifications

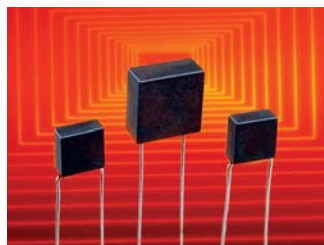

APPLICATIONS

- Oil Well Logging (Downhole)
- Geophysical Probes
- Jet Engine Controls

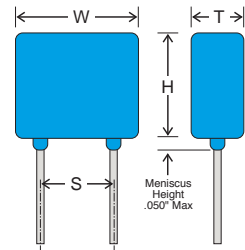

NOTE: Lead lengths are typically 1.25" for orders in bulk packaging. Leads are typically 1.00" for tape and reel packaging. Tape and reel packaging comes in 1000 piece reels.

HOW TO ORDER HIGH VOLTAGE RADIALS

Part number written: 102H42W101KQ4

102	H42	W	101	K	Q	4	
VOLTAGE	SIZE	DIELECTRIC	CAPACITANCE	TOLERANCE	TERMINATION	MARKING	PACKING
501 = 500 V 102 = 1000 V 202 = 2000 V 302 = 3000 V 402 = 4000 V 502 = 5000 V*	See Chart	N = NPO W = X7R	1st two digits are significant; third digit denotes number of zeros. 102 = 1000 pF 103 = 0.01 μ F 105 = 1.00 μ F	J = \pm 5% K = \pm 10% M = \pm 20% Z = +80% -20%	Q = Leaded & Encapsulated	4 = Standard 3 = Specified	T = Tape and Reel H = High Rel Testing per customer requirements S = Special Part



CAPACITOR PACKAGING

Johanson capacitors are available taped per EIA standard 481. Tape options include 7" and 13" diameter reels. Johanson uses high quality, dust free, punched 8mm paper tape and plastic embossed 8mm tape for thicker MLCCs. Quantity per reel ranges are listed in the tables below and are dependent on chip thickness.

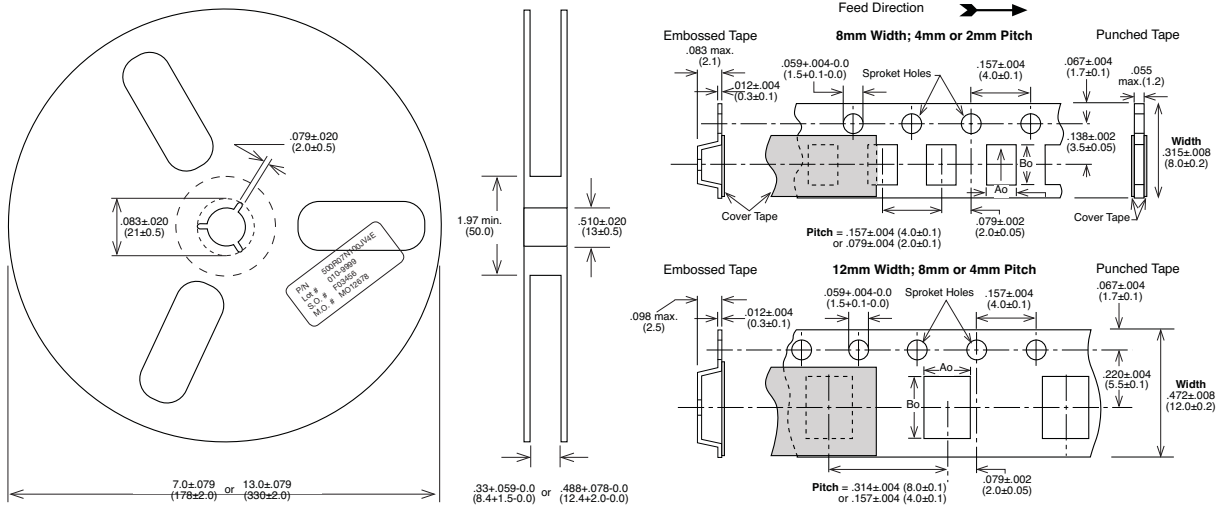
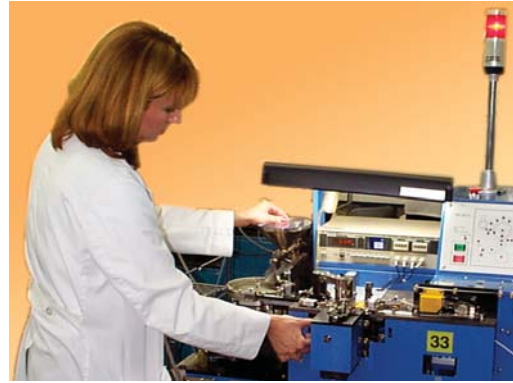

COMPONENT	7" DIAMETER REEL				13" DIAMETER REEL			
	REEL QTY	TAPE TYPE	WIDTH / PITCH	CODE	REEL QTY	TAPE TYPE	WIDTH / PITCH	CODE
R05 / 0201 MLCC	15000	Paper	8mm/2mm	T	N/A	N/A		N/A
R07 / 0402 MLCC	10000	Paper	8mm/2mm	T	N/A	N/A		N/A
R14 / 0603 MLCC	4000	Paper	8mm/4mm	T	10000	Paper	8mm/4mm	R
R15 / 0805 MLCC	4000 / 3000	Paper / Embossed	8mm/4mm	T / E	10000	Paper / Embossed	8mm/4mm	R / U
R18 / 1206 MLCC	4000 / 3000	Paper / Embossed	8mm/4mm	T / E	10000	Paper / Embossed	8mm/4mm	R / U
S41 / 1210 MLCC	2000 - 4000	Embossed	8mm/4mm	E	5000-10000	Embossed	8mm/4mm	U
R29 / 1808 MLCC	2000	Embossed	12mm/4mm	E	5000 - 8000	Embossed	12mm/4mm	U
R30 / 2211 MLCC	1000 - 2000	Embossed	12mm/4mm	E	2000 - 5000	Embossed	12mm/4mm	U
S43 / 1812 MLCC	500 - 1000	Embossed	12mm/8mm	E	3000 - 5000	Embossed	12mm/8mm	U
S47 / 2220 MLCC	250 - 1000	Embossed	12mm/8mm	E	2000 - 5000	Embossed	12mm/8mm	U
S49 / 1825 MLCC	250 - 1000	Embossed	12mm/8mm	E	2000 - 4000	Embossed	12mm/8mm	U
S48 / 2225 MLCC	250 - 1000	Embossed	12mm/8mm	E	2000 - 4000	Embossed	12mm/8mm	U
X07 / 0402 X2Y	4000	Paper	8mm/2mm	T	10000	Paper	8mm/2mm	R
X14 / 0603 X2Y	4000	Paper	8mm/4mm	T	10000	Paper	8mm/4mm	R
X15 / 0805 X2Y	4000	Embossed	8mm/4mm	E	10000	Embossed	8mm/4mm	U
X18 / 1206 X2Y	3000 - 4000	Embossed	8mm/4mm	E	10000	Embossed	8mm/4mm	U
X41 / 1210 X2Y	2000 - 3000	Embossed	8mm/4mm	E				
X44 / 1410 X2Y	1000 - 2000	Embossed	8mm/4mm	E				
X43 / 1812 X2Y	1000	Embossed	12mm/8mm	E				

Actual reel quantities based on part thickness and tape type. Contact sales for reel quantities of specific part numbers.

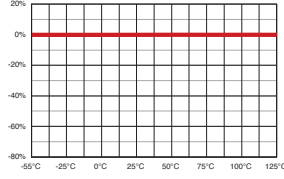
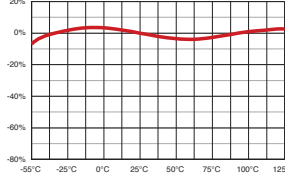
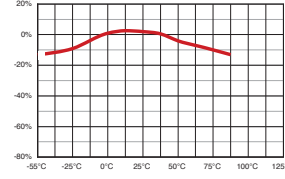

ELECTRICAL CHARACTERISTICS

PARAMETER	NPO		X7R		X5R	
TEMPERATURE COEFFICIENT:	0± 30 ppm/°C	-55 to +125°C	± 15%	-55 to +125°C	± 15%	-55 to +85°C
						
DISSIPATION FACTOR:	.001 (0.1%) max		WVDC ≥ 50 VDC, DF = 2.5% max WVDC = 25 VDC, DF = 3.0% max WVDC = 16 VDC, DF = 3.5% max		For Vrated ≥ 50 VDC, DF = 5% max For Vrated ≤ 25 VDC: DF = 10% max	
AGING:	None		2.5% / decade hour		2.5 % / decade hour	
INSULATION RESISTANCE:	1000ΩF or 100GΩ whichever is less @ 25°C, WVDC		500ΩF or 50GΩ whichever is less @ 25°C, WVDC		100ΩF or 10GΩ whichever is less @ 25°C, WVDC	
DIELECTRIC STRENGTH:	For Vrated = 6 - 200 VDC, DWV = 2.5 X WVDC, 25°C, 50mA max. For Vrated = 201 - 499 VDC, DWV = 2.0 X WVDC, 25°C, 50mA max. For Vrated = 500 - 999 VDC, DWV = 1.5 X WVDC, 25°C, 50mA max. For Vrated = 1000+ VDC, DWV = 1.2 X WVDC, 25°C, 50mA max.				DWV = 2.5 X WVDC, 25°C, 50mA max.	
TEST PARAMETERS:	C > 100 pF; 1kHz ±50Hz; 1.0±0.2 VRMS C ≤ 100 pF 1Mhz ±50kHz; 1.0±0.2 VRMS		1kHz ±50Hz; 1.0±0.2 VRMS		1kHz ±50Hz; 0.5±0.2 VRMS	
NOTES:			Tanceram IR = 100 ΩF or 10 GΩ Tanceram DF for Vrated ≥ 50 VDC = 5% max. Tanceram DF for Vrated ≤ 25 VDC, DF = 10% max			

PART NUMBER BREAKDOWN

Part number written: 500R15N101JV4T

500	R15	N	101	J	V	4	T
VOLTAGE	SIZE	DIELECTRIC	CAPACITANCE	TOLERANCE	TERMINATION	MARKING	PACKING
6R3 = 6.3 V 100 = 10 V 160 = 16 V 250 = 25 V 500 = 50 V 101 = 100 V 201 = 200 V 251 = 250 V 301 = 300 V 501 = 500 V 631 = 630 V 102 = 1000 V 202 = 2000 V 302 = 3000 V 402 = 4000 V 502 = 5000 V ACJ = 250 VAC	R05=0201 R07=0402 R14=0603 R15=0805 A18=0612 R18=1206 S41=1210 R29=1808 R30=2011 S43=1812 S47=2220 S49=1825 S48=2225 X07=0402 X2Y X14=0603 X2Y X15=0805 X2Y X18=1206 X2Y X41=1210 X2Y X44=1410 X2Y X43=1812 X2Y	N = NPO W = X7R X = X5R	1st two digits are significant; third digit denotes number of zeros, R = decimal. 100 = 10 pF 102 = 1,000 pF 474 = 0.47 μF 475 = 4.7 μF 106 = 10 μF	* B = ± 0.10 pF * C = ± 0.25 pF * D = ± 0.50 pF F = ± 1 % G = ± 2 % J = ± 5 % K = ± 10 % M = ± 20 % Z = +80 -20 % *Values < 10 pF only	V = Nickel Barrier with 100% Tin Plating (Matte) F = Polyterm flexible termination T = SnPb P = PdAg	3 = Special (J) 4 = Unmarked 6 = EIA Code* *Not available on sizes ≥ 0402	E = Embossed 7" T = Punched 7" U = Embossed 13" R = Punched 13" No code = bulk pack Tape specifications conform to EIA RS481 Not all tape styles are available on all parts.

PLEASE NOTE: Not all combinations of JDI P/Ns are valid. Please refer to the appropriate "How to Order" section for a particular product or contact your Sales Representative if you need assistance.



Your Technology Partner



High Voltage

AC Safety



X2Y

Tanceram



Low Voltage

Tin-Lead



High Temperature

AC Power



Feedthru Filter

Low ESL



SMPS

Radial Leaded



CORPORATE HEADQUARTERS

15191 Bledsoe Street
Sylmar, California 91342
Tel (818) 364-9800 • FAX (818) 364-6100
<http://www.johansondielectrics.com>



JOHANSON HONG KONG LTD.

Unit E, 11/F, Phase 1, Kaiser Estate
41 Man Yue Street
Hungghom, Kowloon, Hong Kong
Tel: (852) 2334 6310 • Fax: (852) 2334 8858

Компания «Океан Электроники» предлагает заключение долгосрочных отношений при поставках импортных электронных компонентов на взаимовыгодных условиях!

Наши преимущества:

- Поставка оригинальных импортных электронных компонентов напрямую с производств Америки, Европы и Азии, а так же с крупнейших складов мира;
- Широкая линейка поставок активных и пассивных импортных электронных компонентов (более 30 млн. наименований);
- Поставка сложных, дефицитных, либо снятых с производства позиций;
- Оперативные сроки поставки под заказ (от 5 рабочих дней);
- Экспресс доставка в любую точку России;
- Помощь Конструкторского Отдела и консультации квалифицированных инженеров;
- Техническая поддержка проекта, помощь в подборе аналогов, поставка прототипов;
- Поставка электронных компонентов под контролем ВП;
- Система менеджмента качества сертифицирована по Международному стандарту ISO 9001;
- При необходимости вся продукция военного и аэрокосмического назначения проходит испытания и сертификацию в лаборатории (по согласованию с заказчиком);
- Поставка специализированных компонентов военного и аэрокосмического уровня качества (Xilinx, Altera, Analog Devices, Intersil, Interpoint, Microsemi, Actel, Aeroflex, Peregrine, VPT, Syfer, Eurofarad, Texas Instruments, MS Kennedy, Miteq, Cobham, E2V, MA-COM, Hittite, Mini-Circuits, General Dynamics и др.);

Компания «Океан Электроники» является официальным дистрибьютором и эксклюзивным представителем в России одного из крупнейших производителей разъемов военного и аэрокосмического назначения «JONHON», а так же официальным дистрибьютором и эксклюзивным представителем в России производителя высокотехнологичных и надежных решений для передачи СВЧ сигналов «FORSTAR».



JONHON

«JONHON» (основан в 1970 г.)

Разъемы специального, военного и аэрокосмического назначения:

(Применяются в военной, авиационной, аэрокосмической, морской, железнодорожной, горно- и нефтедобывающей отраслях промышленности)

«FORSTAR» (основан в 1998 г.)

ВЧ соединители, коаксиальные кабели, кабельные сборки и микроволновые компоненты:

(Применяются в телекоммуникациях гражданского и специального назначения, в средствах связи, РЛС, а так же военной, авиационной и аэрокосмической отраслях промышленности).



Телефон: 8 (812) 309-75-97 (многоканальный)

Факс: 8 (812) 320-03-32

Электронная почта: ocean@oceanchips.ru

Web: <http://oceanchips.ru/>

Адрес: 198099, г. Санкт-Петербург, ул. Калинина, д. 2, корп. 4, лит. А