

TYPICAL INDICATOR ORDERING EXAMPLE

LB 01 G W01 — 5C12 — JC

Shapes

| | |
|----|-------------|
| 01 | Square |
| 02 | Round |
| 03 | Rectangular |

Housing

| | |
|---|-------|
| K | Black |
| G | Gray |

Terminals

| | |
|-----|---|
| W01 | Silver Solder Lug/ Quick Connect Terminals* |
|-----|---|

Lamps

Incandescent Lamp Used with Solid Cap

| | |
|----|---------|
| 05 | 5-volt |
| 12 | 12-volt |

Incandescent or Neon Used with Insert Cap

| | |
|----|----------------------|
| 01 | 110-volt Neon |
| 05 | 5-volt Incandescent |
| 12 | 12-volt Incandescent |

Bright LED Used with LED Cap

| Colors | | Resistor | |
|--------|-------|----------|-------------|
| 5C | Red | No Code | No Resistor |
| 5D | Amber | 05 | 5-volt |
| | | 12 | 12-volt |
| 5F | Green | 24 | 24-volt |

Super Bright LED Used with LED Cap

| | |
|----|-------|
| 6B | White |
| 6F | Green |
| 6G | Blue |

Cap Types & Colors

Solid Cap: Lens/Filter Colors

| | |
|----|--------------|
| BJ | White/Clear |
| CJ | Red/Clear |
| EJ | Yellow/Clear |
| FJ | Green/Clear |
| GJ | Blue/Clear |

Insert Cap: Lens/Filter Colors

| | |
|-----|--------------|
| JB | Clear/White |
| JC | Clear/Red |
| JE | Clear/Yellow |
| *JF | Clear/Green |
| *JG | Clear/Blue |

*JF & JG not suitable with neon.

LED Cap: Lens/Diffuser Colors

| | |
|----|-------------|
| JB | Clear/White |
| JC | Clear/Red |
| JD | Clear/Amber |
| JF | Clear/Green |

LED Cap: Lens/Diffuser Colors

| | |
|----|-------------|
| JB | Clear/White |
|----|-------------|

* Wire harness & cable assemblies offered only in Americas

DESCRIPTION FOR TYPICAL ORDERING EXAMPLE

LB01GW01-5C12-JC



SHAPES & PANEL CUTOUTS

01 .622" (15.8mm)
Square



02 .854" (21.7mm)
Round

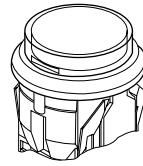

03 .622" x .866" (15.8mm x 22.0mm)
Rectangular



Panel Thickness: .039" ~ .157" (1.0 ~ 4.0mm)

HOUSING

Housing Colors Available:

K Black

G Gray

TERMINALS

W01 Silver Solder Lug/.110" (2.8mm) Quick Connect



LAMP CODES & SPECIFICATIONS

Incandescent Lamp for Solid Colored and Colored Insert Caps

| | | | | |
|---|---------------------|-----------|----------------|--------|
| AT607  T-1 Bi-pin | | 05 | 12 | |
| | Voltage | V | 5V AC | 12V AC |
| | Current | I | 115mA | 60mA |
| | Endurance | Hours | 10,000 average | |
| | Ambient Temp. Range | | -25°C ~ +50°C | |

Neon Lamp for Colored Insert Cap

| | | | |
|--|---------------------|-----------|----------------|
| AT607N  T-1 Bi-pin | | 01 | |
| | Voltage | V | 110V AC |
| | Current | I | 1.5mA |
| | Endurance | Hours | 10,000 average |
| | Ambient Temp. Range | | -25°C ~ +50°C |
| Recommended Resistors: 33K ohms for 110V AC; 100K ohms for 220V AC | | | |

The electrical specifications shown are determined at a basic temperature of 25°C.

LED COLORS & SPECIFICATIONS

The electrical specifications shown are determined at a basic temperature of 25°C. Polarity marks are on the device.
 If the source voltage exceeds the rated voltage, a ballast resistor is required.
 The resistor value can be calculated by using the formula in the Supplement section.
 Additional lamp detail is shown in the Accessories & Hardware section.

Bright LED without Resistor

| | | | | | |
|---|-----------------------------------|------------------|--------------------|--------------------|----------------------------|
| AT635 LEDs are colored in OFF state.   T-1½ Bi-pin | Color Codes | Red 5C | Amber 5D | Green 5F | No Code No Resistor |
| | Forward Peak Current | I_{FM} | | | 30mA |
| | Continuous Forward Current | I_F | | | 20mA |
| | Forward Voltage | V_F | | | 1.9V |
| | Reverse Peak Voltage | V_{RM} | | | 5V |
| | Current Reduction Rate Above 25°C | ΔI_F | | | 0.42mA/°C |
| | Ambient Temperature Range | | | | -25° ~ +50°C |

Bright LED with Resistor

| | | | | | | | |
|---|-----------------------------------|------------------|--------------------|--------------------|----------------|-----------|-----------|
| AT627 with Resistor  T-1 Bi-pin | Color Codes: | Red 5C | Amber 5D | Green 5F | Resistor Codes | | |
| | | | | | 05 | 12 | 24 |
| | Forward Peak Current | I_{FM} | | | — | — | — |
| | Continuous Forward Current | I_F | | | 52mA | 26mA | 13mA |
| | Forward Voltage | V_F | | | 5V | 12V | 24V |
| | Reverse Peak Voltage | V_{RM} | | | 4V | 8V | 16V |
| | Current Reduction Rate Above 25°C | ΔI_F | | | 0.50mA/°C | | |
| Ambient Temperature Range | | | | -25° ~ +50°C | | | |

AT627
5-volt
4-element
with Resistor



AT627
12-volt
4-element
with Resistor



AT627
24-volt
4-element
with Resistor



Super Bright Single Element LED

| | | | | | | |
|--|---|--------------|--------------|-----------|-----------|-----------|
| AT625G Blue AT631B White AT632F Green   T-1 Bi-pin |  | | | 6B | 6F | 6G |
| | | Color | White | Green | Blue | |
| | Forward Peak Current | I_{FM} | 30mA | 30mA | 30mA | |
| | Continuous Forward Current | I_F | 20mA | 20mA | 20mA | |
| | Forward Voltage | V_F | 3.6V | 3.5V | 3.6V | |
| | Reverse Peak Voltage | V_{RM} | 5V | 5V | 5V | |
| | Current Reduction Rate Above 25°C | ΔI_F | 0.50mA/°C | | | |
| | Ambient Temperature Range | | -25° ~ +50°C | | | |

CAP TYPES & COLOR COMBINATIONS

Color Codes: B White C Red D Amber E Yellow F Green G Blue J Clear

Solid Cap for Incandescent Lamp

Lens/Filter
Colors Available:

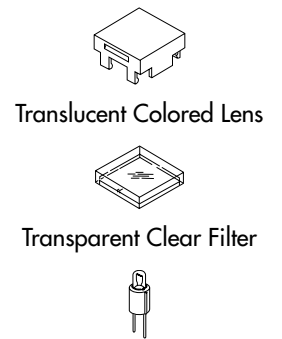

Material: Polycarbonate Finish: Glossy

Lamp AT607

Insert Cap for Incandescent or Neon Lamp

Lens/Filter
Colors Available:

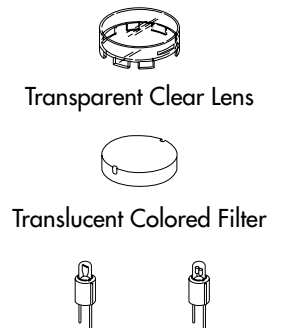
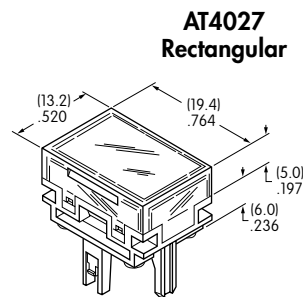
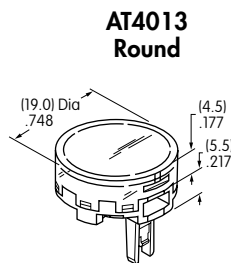
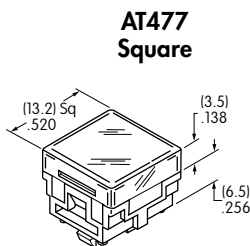
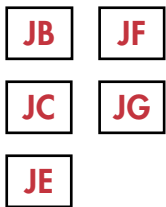

JF and JG not suitable with neon lamp.

Material: Polycarbonate Finish: Glossy

Lamp AT607 or 607N

Cap for Bright LED without Resistor

Lens/Diffuser
Colors Available:

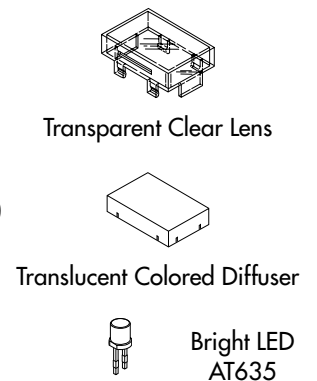
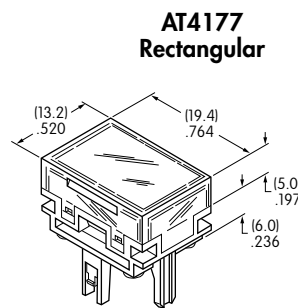
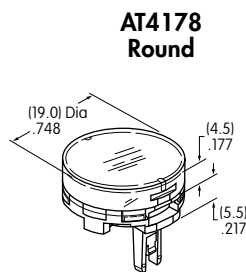
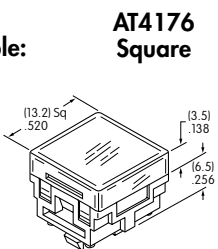

Material: Polycarbonate Finish: Glossy

Bright LED AT635

Cap for Bright LED with Resistor

Lens/Diffuser
Colors Available:

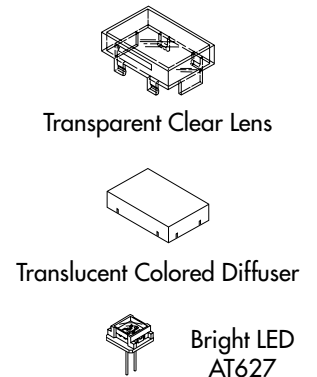
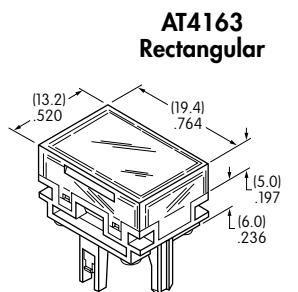
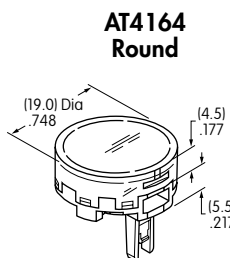
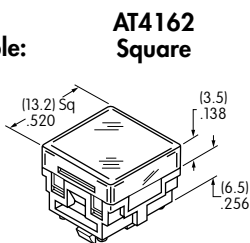

Material: Polycarbonate Finish: Glossy

Bright LED AT627

CAP TYPES & COLOR COMBINATIONS

Cap for Super Bright LEDs



Clear Lens
White Diffuser

AT4129
Square

AT4128
Round

AT4130
Rectangular



Transparent
Clear Lens

Material:
Polycarbonate
Finish: Glossy



Translucent
White Diffuser



LEDs AT625
AT631 AT632

TYPICAL INDICATOR DIMENSIONS

Square



LB01KW01-12-CJ

Round

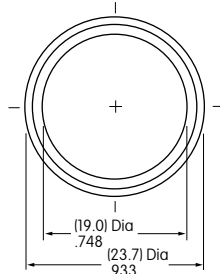

LB02KW01-12-CJ

Rectangular



LB03KW01-12-CJ

Компания «Океан Электроники» предлагает заключение долгосрочных отношений при поставках импортных электронных компонентов на взаимовыгодных условиях!

Наши преимущества:

- Поставка оригинальных импортных электронных компонентов напрямую с производств Америки, Европы и Азии, а так же с крупнейших складов мира;
- Широкая линейка поставок активных и пассивных импортных электронных компонентов (более 30 млн. наименований);
- Поставка сложных, дефицитных, либо снятых с производства позиций;
- Оперативные сроки поставки под заказ (от 5 рабочих дней);
- Экспресс доставка в любую точку России;
- Помощь Конструкторского Отдела и консультации квалифицированных инженеров;
- Техническая поддержка проекта, помощь в подборе аналогов, поставка прототипов;
- Поставка электронных компонентов под контролем ВП;
- Система менеджмента качества сертифицирована по Международному стандарту ISO 9001;
- При необходимости вся продукция военного и аэрокосмического назначения проходит испытания и сертификацию в лаборатории (по согласованию с заказчиком);
- Поставка специализированных компонентов военного и аэрокосмического уровня качества (Xilinx, Altera, Analog Devices, Intersil, Interpoint, Microsemi, Actel, Aeroflex, Peregrine, VPT, Syfer, Eurofarad, Texas Instruments, MS Kennedy, Miteq, Cobham, E2V, MA-COM, Hittite, Mini-Circuits, General Dynamics и др.);

Компания «Океан Электроники» является официальным дистрибьютором и эксклюзивным представителем в России одного из крупнейших производителей разъемов военного и аэрокосмического назначения «JONHON», а так же официальным дистрибьютором и эксклюзивным представителем в России производителя высокотехнологичных и надежных решений для передачи СВЧ сигналов «FORSTAR».



JONHON

«JONHON» (основан в 1970 г.)

Разъемы специального, военного и аэрокосмического назначения:

(Применяются в военной, авиационной, аэрокосмической, морской, железнодорожной, горно- и нефтедобывающей отраслях промышленности)

«FORSTAR» (основан в 1998 г.)

ВЧ соединители, коаксиальные кабели, кабельные сборки и микроволновые компоненты:

(Применяются в телекоммуникациях гражданского и специального назначения, в средствах связи, РЛС, а так же военной, авиационной и аэрокосмической отраслях промышленности).



Телефон: 8 (812) 309-75-97 (многоканальный)

Факс: 8 (812) 320-03-32

Электронная почта: ocean@oceanchips.ru

Web: <http://oceanchips.ru/>

Адрес: 198099, г. Санкт-Петербург, ул. Калинина, д. 2, корп. 4, лит. А