

### TYPICAL INDICATOR ORDERING EXAMPLE

**LB 01 G W01 — 5C12 — JC**

**Shapes**

|    |             |
|----|-------------|
| 01 | Square      |
| 02 | Round       |
| 03 | Rectangular |

**Housing**

|   |       |
|---|-------|
| K | Black |
| G | Gray  |

**Terminals**

|     |   |
|-----|---|
| W01 | Silver Solder Lug/<br>Quick Connect<br>Terminals* |
|-----|---|

**Lamps**

**Incandescent Lamp Used with Solid Cap**

|    |         |
|----|---------|
| 05 | 5-volt  |
| 12 | 12-volt |

**Incandescent or Neon Used with Insert Cap**

|    |                      |
|----|----------------------|
| 01 | 110-volt Neon        |
| 05 | 5-volt Incandescent  |
| 12 | 12-volt Incandescent |

**Bright LED Used with LED Cap**

| Colors |       | Resistor |             |
|--------|-------|----------|-------------|
| 5C     | Red   | No Code  | No Resistor |
| 5D     | Amber | 05       | 5-volt      |
|        |       | 12       | 12-volt     |
| 5F     | Green | 24       | 24-volt     |

**Super Bright LED Used with LED Cap**

|    |       |
|----|-------|
| 6B | White |
| 6F | Green |
| 6G | Blue  |

**Cap Types & Colors**

**Solid Cap: Lens/Filter Colors**

|    |              |
|----|--------------|
| BJ | White/Clear  |
| CJ | Red/Clear    |
| EJ | Yellow/Clear |
| FJ | Green/Clear  |
| GJ | Blue/Clear   |

**Insert Cap: Lens/Filter Colors**

|     |              |
|-----|--------------|
| JB  | Clear/White  |
| JC  | Clear/Red    |
| JE  | Clear/Yellow |
| *JF | Clear/Green  |
| *JG | Clear/Blue   |

\*JF & JG not suitable with neon.

**LED Cap: Lens/Diffuser Colors**

|    |             |
|----|-------------|
| JB | Clear/White |
| JC | Clear/Red   |
| JD | Clear/Amber |
| JF | Clear/Green |

**LED Cap: Lens/Diffuser Colors**

|    |             |
|----|-------------|
| JB | Clear/White |
|----|-------------|

\* Wire harness & cable assemblies offered only in Americas

### DESCRIPTION FOR TYPICAL ORDERING EXAMPLE

#### LB01GW01-5C12-JC



SHAPES & PANEL CUTOUTS

**01** .622" (15.8mm)  
Square



**02** .854" (21.7mm)  
Round



**03** .622" x .866" (15.8mm x 22.0mm)  
Rectangular



Panel Thickness: .039" ~ .157" (1.0 ~ 4.0mm)

HOUSING

Housing Colors Available:

**K** Black

**G** Gray

TERMINALS

**W01** Silver Solder Lug/.110" (2.8mm) Quick Connect



LAMP CODES & SPECIFICATIONS

Incandescent Lamp for Solid Colored and Colored Insert Caps

|   |                     |           |                |        |
|---|---------------------|-----------|----------------|--------|
| <b>AT607</b><br><br><br>T-1 Bi-pin |                     | <b>05</b> | <b>12</b>      |        |
|   | Voltage             | V         | 5V AC          | 12V AC |
|   | Current             | I         | 115mA          | 60mA   |
|   | Endurance           | Hours     | 10,000 average |        |
|   | Ambient Temp. Range |           | -25°C ~ +50°C  |        |

Neon Lamp for Colored Insert Cap

|  |                     |           |                |
|--|---------------------|-----------|----------------|
| <b>AT607N</b><br><br><br>T-1 Bi-pin |                     | <b>01</b> |                |
|  | Voltage             | V         | 110V AC        |
|  | Current             | I         | 1.5mA          |
|  | Endurance           | Hours     | 10,000 average |
|  | Ambient Temp. Range |           | -25°C ~ +50°C  |
| Recommended Resistors: 33K ohms for 110V AC; 100K ohms for 220V AC   |                     |           |                |

The electrical specifications shown are determined at a basic temperature of 25°C.

### LED COLORS & SPECIFICATIONS

The electrical specifications shown are determined at a basic temperature of 25°C. Polarity marks are on the device.  
 If the source voltage exceeds the rated voltage, a ballast resistor is required.  
 The resistor value can be calculated by using the formula in the Supplement section.  
 Additional lamp detail is shown in the Accessories & Hardware section.

#### Bright LED without Resistor

|   |                                   |                  |                    |                    |                            |           |           |       |
|---|-----------------------------------|------------------|--------------------|--------------------|----------------------------|-----------|-----------|-------|
| <b>AT635</b><br>LEDs are colored in OFF state.<br><br><br>T-1½ Bi-pin | Color Codes                       | Red<br><b>5C</b> | Amber<br><b>5D</b> | Green<br><b>5F</b> | <b>No Code</b> No Resistor | Red       | Amber     | Green |
|   | Forward Peak Current              | $I_{FM}$         |                    |                    | 30mA                       | 30mA      | 30mA      |       |
|   | Continuous Forward Current        | $I_F$            |                    |                    | 20mA                       | 20mA      | 20mA      |       |
|   | Forward Voltage                   | $V_F$            |                    |                    | 1.9V                       | 2.0V      | 2.1V      |       |
|   | Reverse Peak Voltage              | $V_{RM}$         |                    |                    | 5V                         | 5V        | 5V        |       |
|   | Current Reduction Rate Above 25°C | $\Delta I_F$     |                    |                    | 0.42mA/°C                  | 0.42mA/°C | 0.42mA/°C |       |
|   | Ambient Temperature Range         | -25° ~ +50°C     |                    |                    |                            |           |           |       |

#### Bright LED with Resistor

|   |                                   |                  |                    |                    |                |      |      |
|---|-----------------------------------|------------------|--------------------|--------------------|----------------|------|------|
| <b>AT627 with Resistor</b><br><br>T-1 Bi-pin | Color Codes:                      | Red<br><b>5C</b> | Amber<br><b>5D</b> | Green<br><b>5F</b> | Resistor Codes |      |      |
|   |                                   | <b>05</b>        | <b>12</b>          | <b>24</b>          |                |      |      |
|   | Forward Peak Current              | $I_{FM}$         |                    |                    | —              | —    | —    |
|   | Continuous Forward Current        | $I_F$            |                    |                    | 52mA           | 26mA | 13mA |
|   | Forward Voltage                   | $V_F$            |                    |                    | 5V             | 12V  | 24V  |
|   | Reverse Peak Voltage              | $V_{RM}$         |                    |                    | 4V             | 8V   | 16V  |
|   | Current Reduction Rate Above 25°C | $\Delta I_F$     |                    |                    | 0.50mA/°C      |      |      |
| Ambient Temperature Range   | -25° ~ +50°C                      |                  |                    |                    |                |      |      |

AT627  
5-volt  
4-element  
with Resistor



AT627  
12-volt  
4-element  
with Resistor



AT627  
24-volt  
4-element  
with Resistor

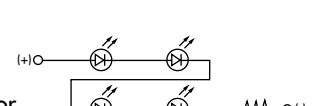

#### Super Bright Single Element LED

|  |   |              |           |           |           |           |
|--|---|--------------|-----------|-----------|-----------|-----------|
| <b>AT625G Blue</b><br><b>AT631B White</b><br><b>AT632F Green</b><br><br><br>T-1 Bi-pin |  |              |           | <b>6B</b> | <b>6F</b> | <b>6G</b> |
|  |   | Color        | White     | Green     | Blue      |           |
|  | Forward Peak Current  | $I_{FM}$     | 30mA      | 30mA      | 30mA      |           |
|  | Continuous Forward Current  | $I_F$        | 20mA      | 20mA      | 20mA      |           |
|  | Forward Voltage   | $V_F$        | 3.6V      | 3.5V      | 3.6V      |           |
|  | Reverse Peak Voltage  | $V_{RM}$     | 5V        | 5V        | 5V        |           |
|  | Current Reduction Rate Above 25°C   | $\Delta I_F$ | 0.50mA/°C |           |           |           |
|  | Ambient Temperature Range   | -25° ~ +50°C |           |           |           |           |

**CAP TYPES & COLOR COMBINATIONS**

Color Codes: B White C Red D Amber E Yellow F Green G Blue J Clear

**Solid Cap for Incandescent Lamp**

Lens/Filter  
Colors Available:

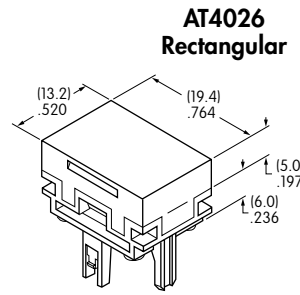

Material: Polycarbonate Finish: Glossy

**Insert Cap for Incandescent or Neon Lamp**

Lens/Filter  
Colors Available:

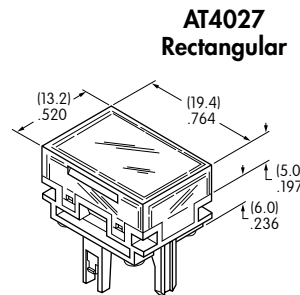

JF and JG not suitable with neon lamp.

Material: Polycarbonate Finish: Glossy

**Cap for Bright LED without Resistor**

Lens/Diffuser  
Colors Available:

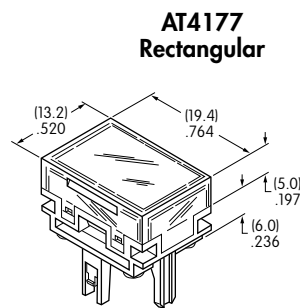
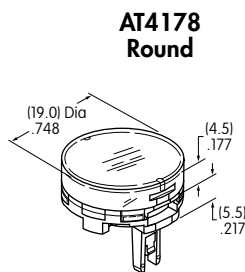

Material: Polycarbonate Finish: Glossy

**Cap for Bright LED with Resistor**

Lens/Diffuser  
Colors Available:

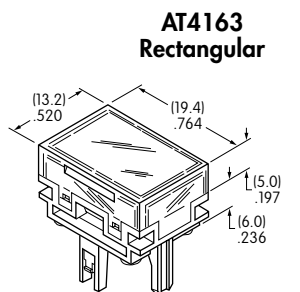

Material: Polycarbonate Finish: Glossy

### CAP TYPES & COLOR COMBINATIONS

#### Cap for Super Bright LEDs



Clear Lens  
White Diffuser

AT4129  
Square

AT4128  
Round

AT4130  
Rectangular



Transparent  
Clear Lens

Material:  
Polycarbonate  
Finish: Glossy

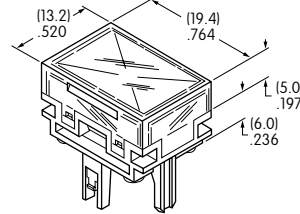
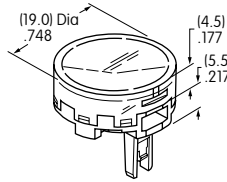
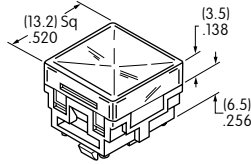

Translucent  
White Diffuser



LEDs AT625  
AT631 AT632

### TYPICAL INDICATOR DIMENSIONS

#### Square

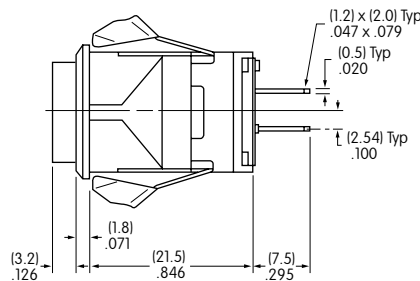

LB01KW01-12-CJ

#### Round

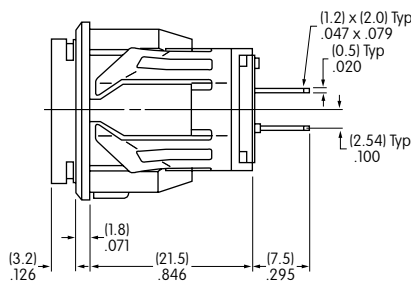
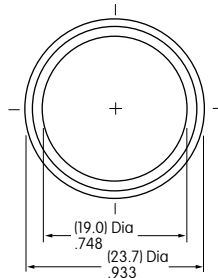

LB02KW01-12-CJ

#### Rectangular

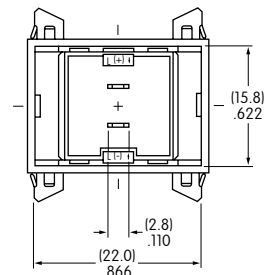
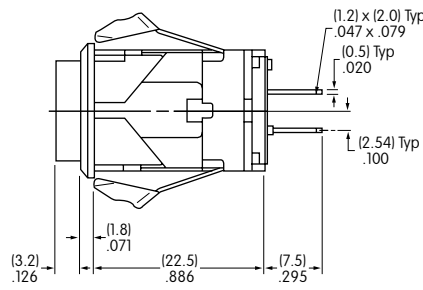
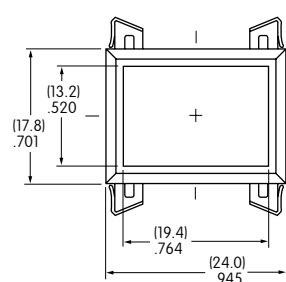

LB03KW01-12-CJ

Компания «Океан Электроники» предлагает заключение долгосрочных отношений при поставках импортных электронных компонентов на взаимовыгодных условиях!

Наши преимущества:

- Поставка оригинальных импортных электронных компонентов напрямую с производств Америки, Европы и Азии, а так же с крупнейших складов мира;
- Широкая линейка поставок активных и пассивных импортных электронных компонентов (более 30 млн. наименований);
- Поставка сложных, дефицитных, либо снятых с производства позиций;
- Оперативные сроки поставки под заказ (от 5 рабочих дней);
- Экспресс доставка в любую точку России;
- Помощь Конструкторского Отдела и консультации квалифицированных инженеров;
- Техническая поддержка проекта, помощь в подборе аналогов, поставка прототипов;
- Поставка электронных компонентов под контролем ВП;
- Система менеджмента качества сертифицирована по Международному стандарту ISO 9001;
- При необходимости вся продукция военного и аэрокосмического назначения проходит испытания и сертификацию в лаборатории (по согласованию с заказчиком);
- Поставка специализированных компонентов военного и аэрокосмического уровня качества (Xilinx, Altera, Analog Devices, Intersil, Interpoint, Microsemi, Actel, Aeroflex, Peregrine, VPT, Syfer, Eurofarad, Texas Instruments, MS Kennedy, Miteq, Cobham, E2V, MA-COM, Hittite, Mini-Circuits, General Dynamics и др.);

Компания «Океан Электроники» является официальным дистрибьютором и эксклюзивным представителем в России одного из крупнейших производителей разъемов военного и аэрокосмического назначения «JONHON», а так же официальным дистрибьютором и эксклюзивным представителем в России производителя высокотехнологичных и надежных решений для передачи СВЧ сигналов «FORSTAR».



## JONHON

«JONHON» (основан в 1970 г.)

Разъемы специального, военного и аэрокосмического назначения:

(Применяются в военной, авиационной, аэрокосмической, морской, железнодорожной, горно- и нефтедобывающей отраслях промышленности)

«FORSTAR» (основан в 1998 г.)

ВЧ соединители, коаксиальные кабели,  
кабельные сборки и микроволновые компоненты:

(Применяются в телекоммуникациях гражданского и специального назначения, в средствах связи, РЛС, а так же военной, авиационной и аэрокосмической отраслях промышленности).



Телефон: 8 (812) 309-75-97 (многоканальный)

Факс: 8 (812) 320-03-32

Электронная почта: [ocean@oceanchips.ru](mailto:ocean@oceanchips.ru)

Web: <http://oceanchips.ru/>

Адрес: 198099, г. Санкт-Петербург, ул. Калинина, д. 2, корп. 4, лит. А