

## Dual P-Channel 20 V (D-S) MOSFET

PRODUCT SUMMARY			
$V_{DS}$ (V)	$R_{DS(on)}$ ( $\Omega$ )	$I_D$ (A)	$Q_g$ (Typ.)
- 20	0.490 at $V_{GS} = - 4.5$ V	- 1.3 <sup>a</sup>	1.6 nC
	0.640 at $V_{GS} = - 2.5$ V	- 1.2	
	0.790 at $V_{GS} = - 1.8$ V	- 1.0	

### FEATURES

- Halogen-free According to IEC 61249-2-21 Definition
- TrenchFET<sup>®</sup> Power MOSFET
- PWM Optimized
- Compliant to RoHS Directive 2002/95/EC



**RoHS**  
COMPLIANT  
**HALOGEN**  
**FREE**  
Available

### APPLICATIONS

- Load Switch for Portable Devices

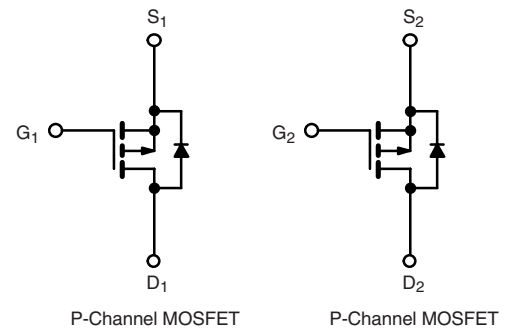
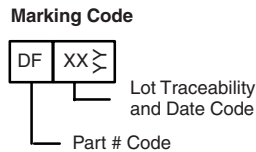
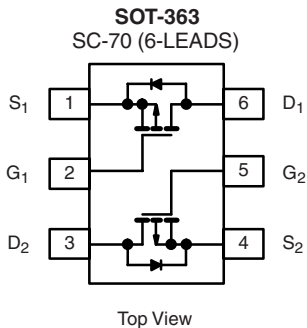

Ordering Information: Si1967DH-T1-E3 (Lead (Pb)-free)  
Si1967DH-T1-GE3 (Lead (Pb)-free and Halogen-free)

ABSOLUTE MAXIMUM RATINGS $T_A = 25$ °C, unless otherwise noted			
Parameter	Symbol	Limit	Unit
Drain-Source Voltage	$V_{DS}$	- 20	V
Gate-Source Voltage	$V_{GS}$	$\pm 8$	
Continuous Drain Current ( $T_J = 150$ °C)	$T_C = 25$ °C	- 1.3 <sup>a</sup>	A
	$T_C = 70$ °C	- 1.1	
	$T_A = 25$ °C	- 1.0 <sup>b, c</sup>	
	$T_A = 70$ °C	- 0.83 <sup>b, c</sup>	
Pulsed Drain Current	$I_{DM}$	- 3	
Continuous Source-Drain Diode Current	$T_C = 25$ °C	- 1	
	$T_A = 25$ °C	- 0.6 <sup>b, c</sup>	
Maximum Power Dissipation	$T_C = 25$ °C	1.25	W
	$T_C = 70$ °C	0.8	
	$T_A = 25$ °C	0.74 <sup>b, c</sup>	
	$T_A = 70$ °C	0.47 <sup>b, c</sup>	
Operating Junction and Storage Temperature Range	$T_J, T_{stg}$	- 55 to 150	°C

THERMAL RESISTANCE RATINGS					
Parameter	Symbol	Typical	Maximum	Unit	
Maximum Junction-to-Ambient <sup>b, d</sup>	$t \leq 5$ s	$R_{thJA}$	130	170	°C/W
Maximum Junction-to-Foot (Drain)	Steady State	$R_{thJF}$	80	100	

Notes:

- Package limited.
- Surface mounted on 1" x 1" FR4 board.
- $t = 5$  s.
- Maximum under steady state conditions is 220 °C/W.

SPECIFICATIONS $T_J = 25\text{ }^\circ\text{C}$ , unless otherwise noted						
Parameter	Symbol	Test Conditions	Min.	Typ.	Max.	Unit
<b>Static</b>						
Drain-Source Breakdown Voltage	$V_{DS}$	$V_{GS} = 0\text{ V}, I_D = -250\text{ }\mu\text{A}$	- 20			V
$V_{DS}$ Temperature Coefficient	$\Delta V_{DS}/T_J$	$I_D = -250\text{ }\mu\text{A}$		- 20		mV/ $^\circ\text{C}$
$V_{GS(th)}$ Temperature Coefficient	$\Delta V_{GS(th)}/T_J$		2			
Gate-Source Threshold Voltage	$V_{GS(th)}$	$V_{DS} = V_{GS}, I_D = -250\text{ }\mu\text{A}$	- 0.4		- 1.0	V
Gate-Source Leakage	$I_{GSS}$	$V_{DS} = 0\text{ V}, V_{GS} = \pm 8\text{ V}$			$\pm 100$	nA
Zero Gate Voltage Drain Current	$I_{DSS}$	$V_{DS} = -20\text{ V}, V_{GS} = 0\text{ V}$			- 1	$\mu\text{A}$
		$V_{DS} = -20\text{ V}, V_{GS} = 0\text{ V}, T_J = 85\text{ }^\circ\text{C}$			- 10	
On-State Drain Current <sup>a</sup>	$I_{D(on)}$	$V_{DS} \leq -5\text{ V}, V_{GS} = -4.5\text{ V}$	- 3			A
Drain-Source On-State Resistance <sup>a</sup>	$R_{DS(on)}$	$V_{GS} = -4.5\text{ V}, I_D = -0.91\text{ A}$		0.390	0.490	$\Omega$
		$V_{GS} = -2.5\text{ V}, I_D = -0.8\text{ A}$		0.500	0.640	
		$V_{GS} = -1.8\text{ V}, I_D = -0.25\text{ A}$		0.640	0.790	
Forward Transconductance <sup>a</sup>	$g_{fs}$	$V_{DS} = -10\text{ V}, I_D = -0.91\text{ A}$		2		S
<b>Dynamic<sup>b</sup></b>						
Input Capacitance	$C_{iss}$	$V_{DS} = -10\text{ V}, V_{GS} = 0\text{ V}, f = 1\text{ MHz}$		110		$\mu\text{F}$
Output Capacitance	$C_{oss}$		26			
Reverse Transfer Capacitance	$C_{rss}$		16			
Total Gate Charge	$Q_g$	$V_{DS} = -10\text{ V}, V_{GS} = -8\text{ V}, I_D = -1.1\text{ A}$		2.6	4.0	nC
			$V_{DS} = -10\text{ V}, V_{GS} = -4.5\text{ V}, I_D = -1.1\text{ A}$		1.6	
Gate-Source Charge	$Q_{gs}$			0.36		
Gate-Drain Charge	$Q_{gd}$			0.33		
Gate Resistance	$R_g$	$f = 1\text{ MHz}$		7.5		$\Omega$
Turn-On Delay Time	$t_{d(on)}$	$V_{DD} = -10\text{ V}, R_L = 12\text{ }\Omega$ $I_D \cong -0.83\text{ A}, V_{GEN} = -4.5\text{ V}, R_g = 1\text{ }\Omega$		12	20	ns
Rise Time	$t_r$			27	40	
Turn-Off Delay Time	$t_{d(off)}$			15	25	
Fall Time	$t_f$			10	15	
Turn-On Delay Time	$t_{d(on)}$	$V_{DD} = -10\text{ V}, R_L = 12\text{ }\Omega$ $I_D \cong -0.83\text{ A}, V_{GEN} = -8\text{ V}, R_g = 1\text{ }\Omega$		2	5	
Rise Time	$t_r$			12	20	
Turn-Off Delay Time	$t_{d(off)}$			12	20	
Fall Time	$t_f$			10	15	
<b>Drain-Source Body Diode Characteristics</b>						
Continuous Source-Drain Diode Current	$I_S$	$T_C = 25\text{ }^\circ\text{C}$			- 1.0	A
Pulse Diode Forward Current <sup>a</sup>	$I_{SM}$				- 3.0	
Body Diode Voltage	$V_{SD}$	$I_S = -0.9\text{ A}$		- 0.8	- 1.2	V
Body Diode Reverse Recovery Time	$t_{rr}$	$I_F = -0.83\text{ A}, di/dt = 100\text{ A}/\mu\text{s}, T_J = 25\text{ }^\circ\text{C}$		25	50	ns
Body Diode Reverse Recovery Charge	$Q_{rr}$			15	30	nC
Reverse Recovery Fall Time	$t_a$			12		ns
Reverse Recovery Rise Time	$t_b$			13		

Notes:

- a. Pulse test; pulse width  $\leq 300\text{ }\mu\text{s}$ , duty cycle  $\leq 2\%$   
b. Guaranteed by design, not subject to production testing.

Stresses beyond those listed under "Absolute Maximum Ratings" may cause permanent damage to the device. These are stress ratings only, and functional operation of the device at these or any other conditions beyond those indicated in the operational sections of the specifications is not implied. Exposure to absolute maximum rating conditions for extended periods may affect device reliability.

## TYPICAL CHARACTERISTICS 25 °C, unless otherwise noted

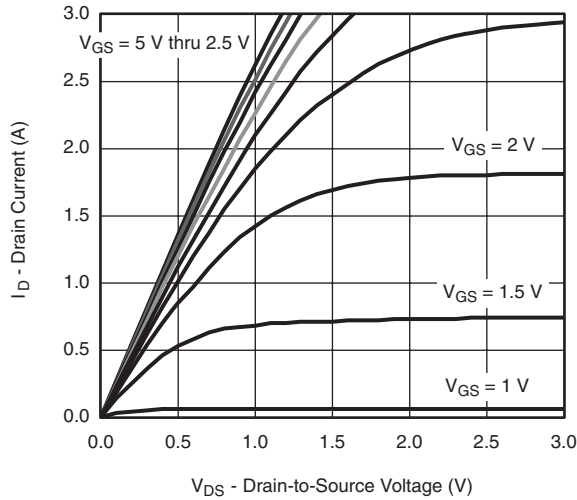

**Output Characteristics**

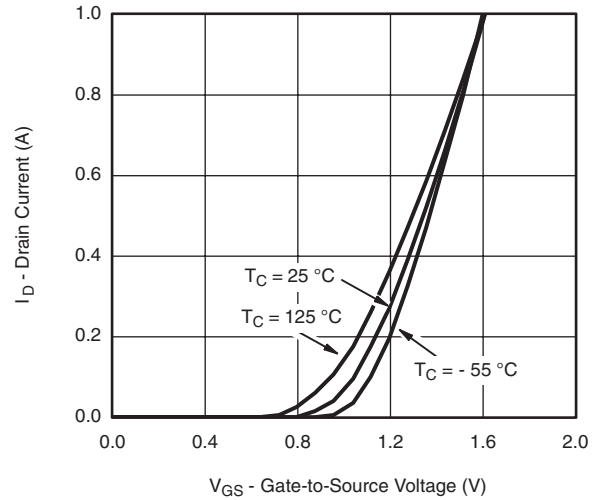

**Transfer Characteristics**

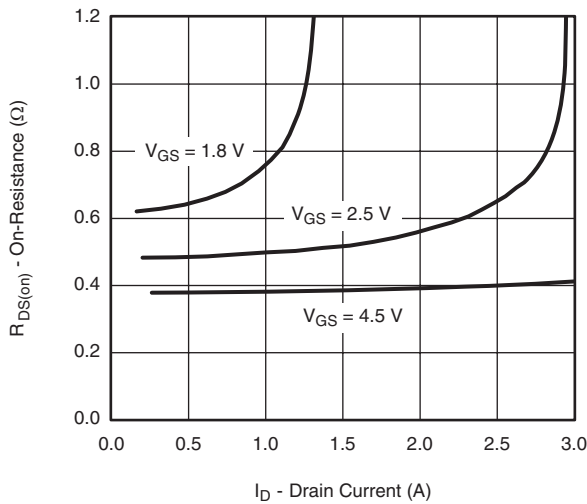

**On-Resistance vs. Drain Current and Gate Voltage**

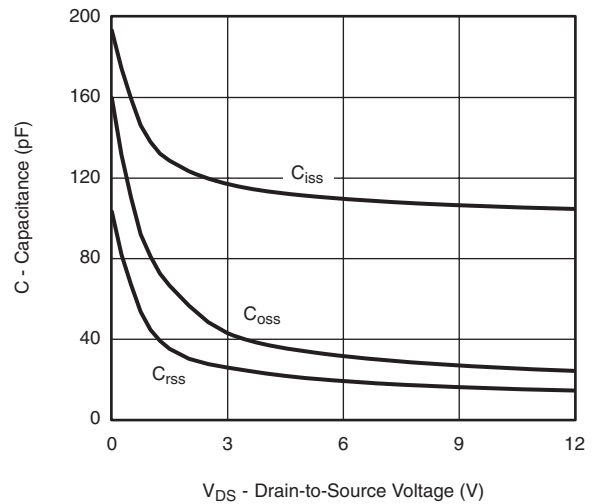

**Capacitance**

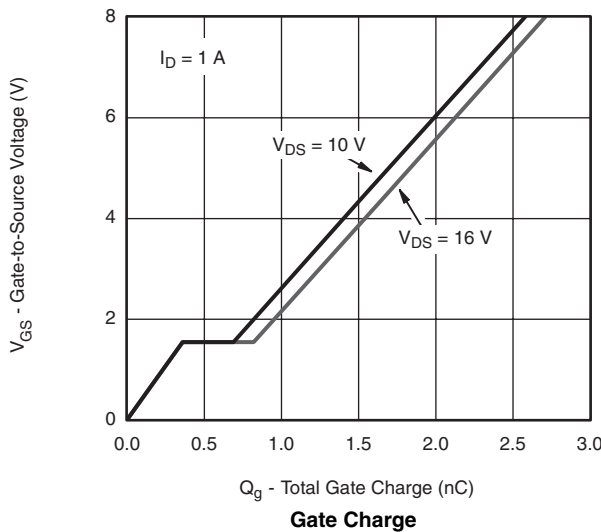

**Gate Charge**

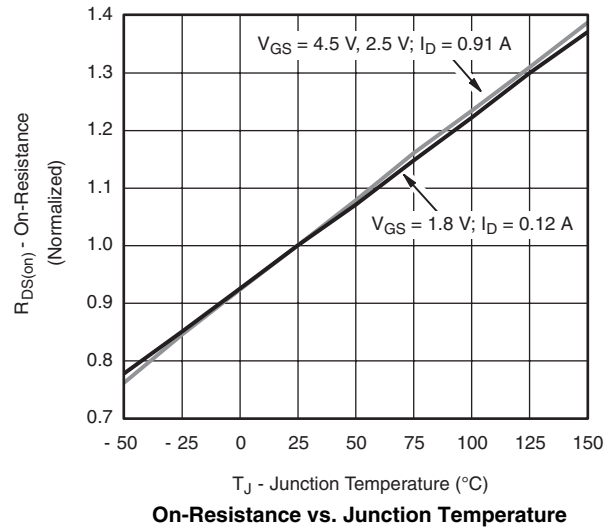

**On-Resistance vs. Junction Temperature**

**TYPICAL CHARACTERISTICS** 25 °C, unless otherwise noted

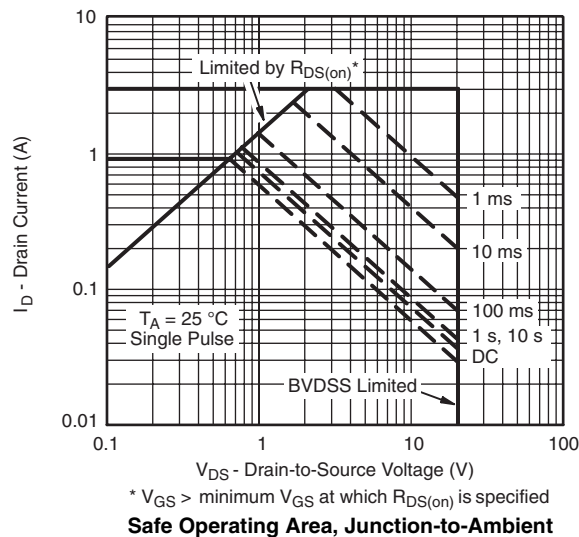
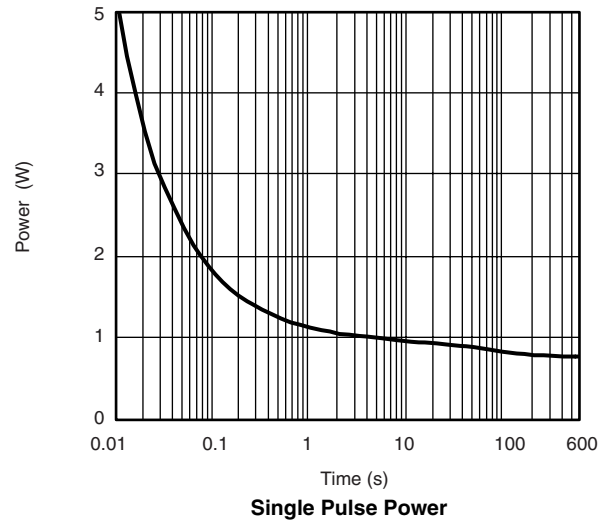
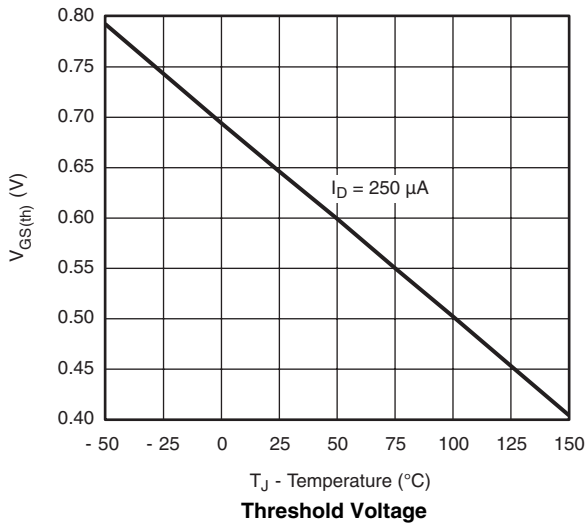
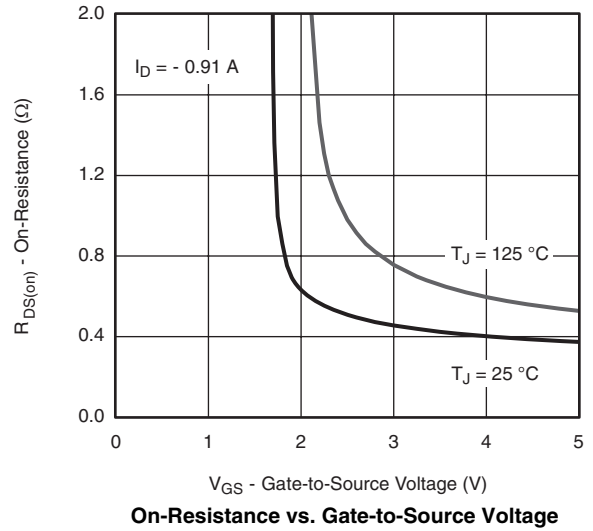
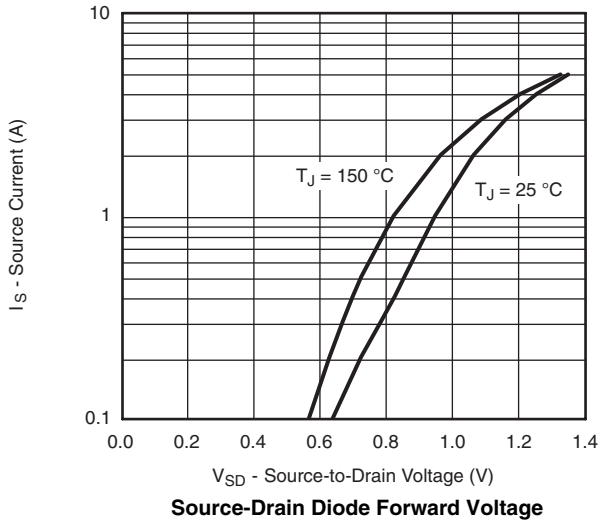

**TYPICAL CHARACTERISTICS** 25 °C, unless otherwise noted

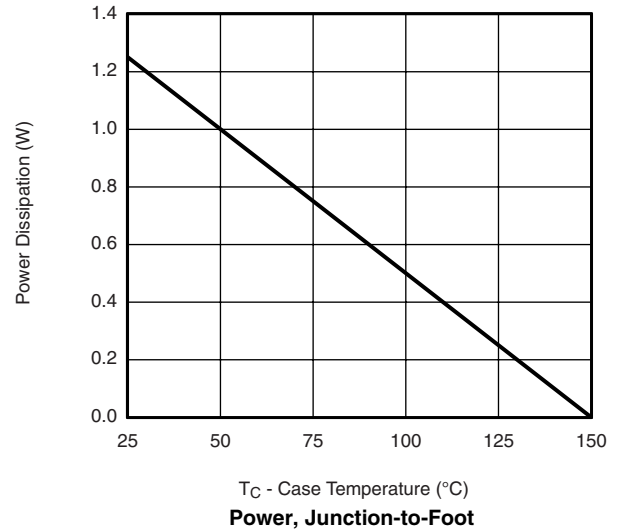
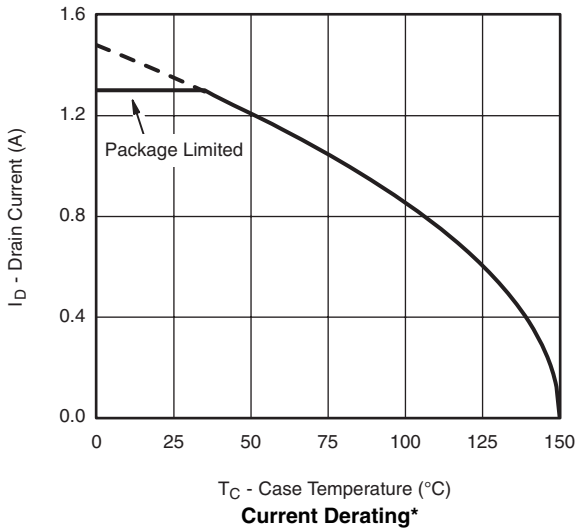

\* The power dissipation  $P_D$  is based on  $T_{J(max)} = 150$  °C, using junction-to-case thermal resistance, and is more useful in settling the upper dissipation limit for cases where additional heatsinking is used. It is used to determine the current rating, when this rating falls below the package limit.

### TYPICAL CHARACTERISTICS 25 °C, unless otherwise noted

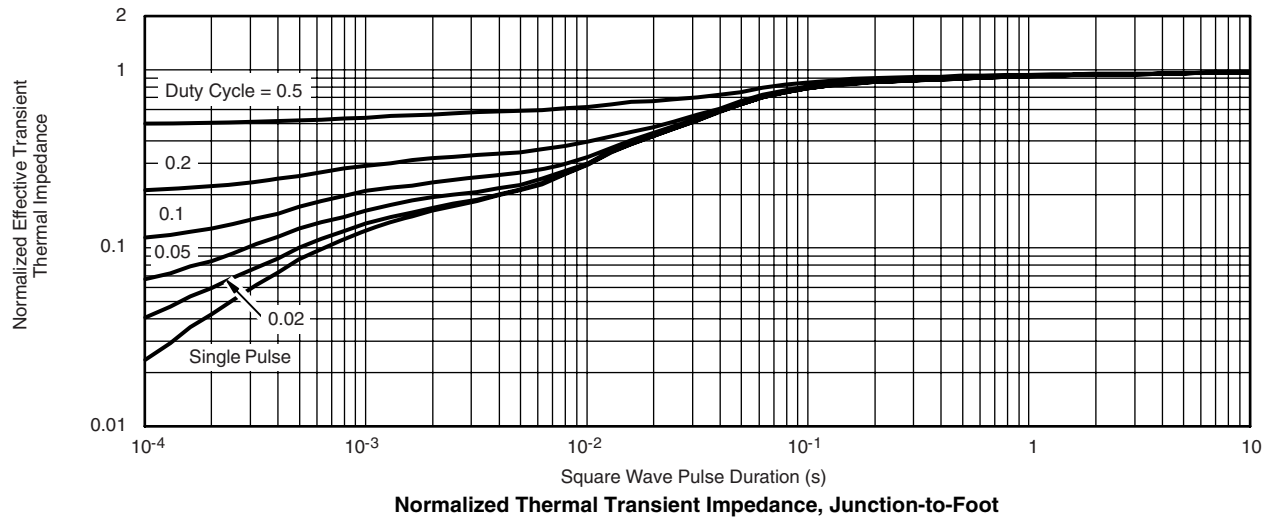
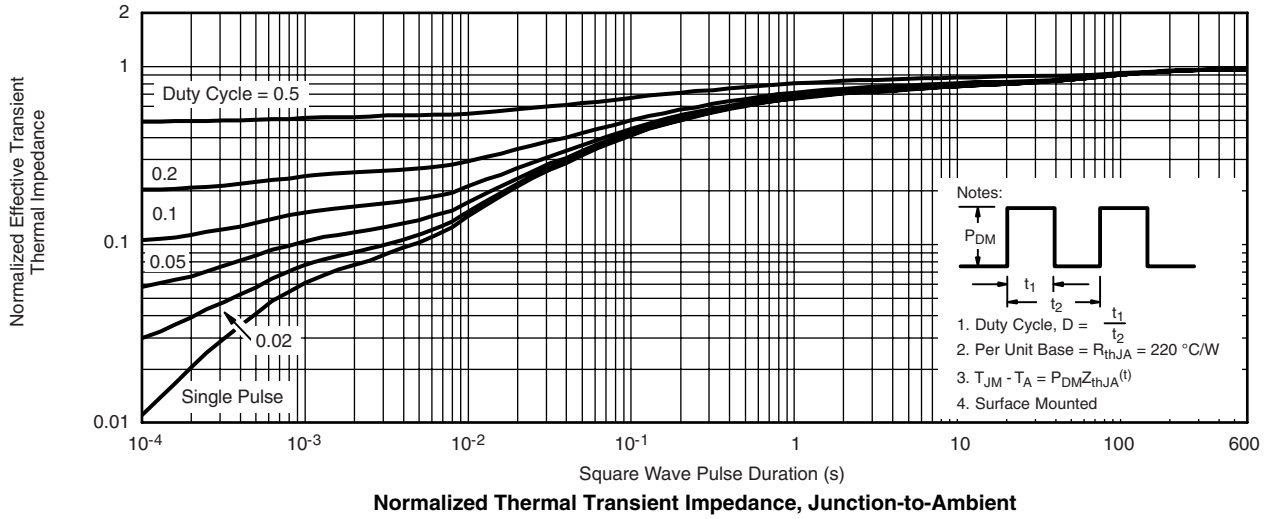

Vishay Siliconix maintains worldwide manufacturing capability. Products may be manufactured at one of several qualified locations. Reliability data for Silicon Technology and Package Reliability represent a composite of all qualified locations. For related documents such as package/tape drawings, part marking, and reliability data, see [www.vishay.com/ppq?68784](http://www.vishay.com/ppq?68784).



## Disclaimer

All product specifications and data are subject to change without notice.

Vishay Intertechnology, Inc., its affiliates, agents, and employees, and all persons acting on its or their behalf (collectively, "Vishay"), disclaim any and all liability for any errors, inaccuracies or incompleteness contained herein or in any other disclosure relating to any product.

Vishay disclaims any and all liability arising out of the use or application of any product described herein or of any information provided herein to the maximum extent permitted by law. The product specifications do not expand or otherwise modify Vishay's terms and conditions of purchase, including but not limited to the warranty expressed therein, which apply to these products.

No license, express or implied, by estoppel or otherwise, to any intellectual property rights is granted by this document or by any conduct of Vishay.

The products shown herein are not designed for use in medical, life-saving, or life-sustaining applications unless otherwise expressly indicated. Customers using or selling Vishay products not expressly indicated for use in such applications do so entirely at their own risk and agree to fully indemnify Vishay for any damages arising or resulting from such use or sale. Please contact authorized Vishay personnel to obtain written terms and conditions regarding products designed for such applications.

Product names and markings noted herein may be trademarks of their respective owners.

Компания «Океан Электроники» предлагает заключение долгосрочных отношений при поставках импортных электронных компонентов на взаимовыгодных условиях!

Наши преимущества:

- Поставка оригинальных импортных электронных компонентов напрямую с производств Америки, Европы и Азии, а так же с крупнейших складов мира;
- Широкая линейка поставок активных и пассивных импортных электронных компонентов (более 30 млн. наименований);
- Поставка сложных, дефицитных, либо снятых с производства позиций;
- Оперативные сроки поставки под заказ (от 5 рабочих дней);
- Экспресс доставка в любую точку России;
- Помощь Конструкторского Отдела и консультации квалифицированных инженеров;
- Техническая поддержка проекта, помощь в подборе аналогов, поставка прототипов;
- Поставка электронных компонентов под контролем ВП;
- Система менеджмента качества сертифицирована по Международному стандарту ISO 9001;
- При необходимости вся продукция военного и аэрокосмического назначения проходит испытания и сертификацию в лаборатории (по согласованию с заказчиком);
- Поставка специализированных компонентов военного и аэрокосмического уровня качества (Xilinx, Altera, Analog Devices, Intersil, Interpoint, Microsemi, Actel, Aeroflex, Peregrine, VPT, Syfer, Eurofarad, Texas Instruments, MS Kennedy, Miteq, Cobham, E2V, MA-COM, Hittite, Mini-Circuits, General Dynamics и др.);

Компания «Океан Электроники» является официальным дистрибьютором и эксклюзивным представителем в России одного из крупнейших производителей разъемов военного и аэрокосмического назначения «JONHON», а так же официальным дистрибьютором и эксклюзивным представителем в России производителя высокотехнологичных и надежных решений для передачи СВЧ сигналов «FORSTAR».



## JONHON

«JONHON» (основан в 1970 г.)

Разъемы специального, военного и аэрокосмического назначения:

(Применяются в военной, авиационной, аэрокосмической, морской, железнодорожной, горно- и нефтедобывающей отраслях промышленности)

«FORSTAR» (основан в 1998 г.)

ВЧ соединители, коаксиальные кабели,  
кабельные сборки и микроволновые компоненты:

(Применяются в телекоммуникациях гражданского и специального назначения, в средствах связи, РЛС, а так же военной, авиационной и аэрокосмической отраслях промышленности).



Телефон: 8 (812) 309-75-97 (многоканальный)

Факс: 8 (812) 320-03-32

Электронная почта: [ocean@oceanchips.ru](mailto:ocean@oceanchips.ru)

Web: <http://oceanchips.ru/>

Адрес: 198099, г. Санкт-Петербург, ул. Калинина, д. 2, корп. 4, лит. А