

# EE-SY671/672

## Photomicrosensor with sensitivity adjuster.

- Easy adjustment with a built-in sensitivity adjuster.
- Easy optical axis monitoring with a bright light indicator.
- Compact design incorporating a built-in amplifier and special IC enables direct switching capacity of up to 100 mA.
- Wide operating voltage range: 5 to 24 VDC
- Connection possible with a range of ICs, relays, and Programmable Controllers (PLCs).

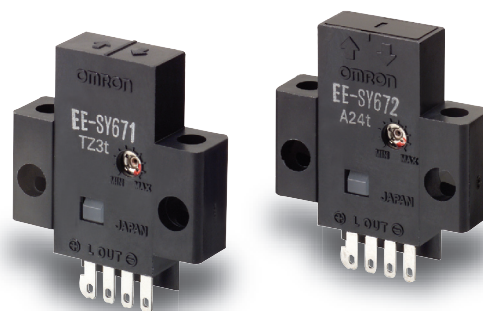



 Be sure to read *Safety Precautions* on page 4.

## Ordering Information

### Sensors

 Infrared light

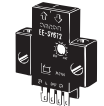
| Appearance  | Sensing method  | Sensing distance  | Output type | Output configuration               | Model    |
|---|-----------------|---|-------------|------------------------------------|----------|
| Horizontal type<br> | Reflective type |  1 to 5 mm | NPN output  | Dark-ON or Light-ON (Selectable) * | EE-SY671 |
| Vertical type<br>  |                 |   |             |                                    | EE-SY672 |

\* The Dark-ON/Light-ON (selectable) models are normally used as dark-ON models. To use them as light-ON models, short-circuit the L terminal and positive (+) terminal.  
An EE-1001-1 Connector with the terminals already short-circuited is also available.

### Accessories (Order Separately)

| Type                       | Cable length | Model     | Remarks   |
|----------------------------|--------------|-----------|---|
| Connector                  |              | EE-1001   |   |
|                            |              | EE-1001-1 | L terminal and positive (+) terminal are already short-circuited. |
|                            |              | EE-1009   |   |
| Connector with Cable       | 1 m          | EE-1006   |   |
|                            |              | EE-1010   |   |
|                            | 2 m          | EE-1006   |   |
|                            |              | EE-1010   |   |
| Connector with Robot Cable | 1 m          | EE-1010-R |   |
|                            | 2 m          | EE-1010-R |   |

\* Refer to *Accessories* for details.

## Ratings and Specifications

| Item                      | Models           | EE-SY671, EE-SY672  |
|---------------------------|------------------|---|
| Sensing distance          |                  | 1 to 5 mm (Reflection factor: 90%; white paper 15 × 15 mm)  |
| Sensing object            |                  | Transparent or opaque: 15 × 15 mm min.  |
| Differential distance     |                  | 0.5 max. (with a sensing distance of 3 mm, horizontally)  |
| Light source              |                  | GaAs infrared LED with a peak wavelength of 940 nm  |
| Indicator *1              |                  | Light indicator (red)   |
| Supply voltage            |                  | 5 to 24 VDC ±10%, ripple (p-p): 10% max.  |
| Current consumption       |                  | 40 mA max.  |
| Control output            |                  | NPN open collector:<br>Load power supply voltage: 5 to 24 VDC<br>Load current: 100 mA max.<br>OFF current: 0.5 mA max.<br>100 mA load current with a residual voltage of 0.8 V max.<br>40 mA load current with a residual voltage of 0.4 V max. |
| Response frequency *2     |                  | 50 Hz min. (Average: 500 Hz)  |
| Ambient illumination *3   |                  | 1,500 lx max. with fluorescent light on the surface of the receiver   |
| Ambient temperature range |                  | Operating: -25 to +55°C<br>Storage: -30 to +80°C  |
| Ambient humidity range    |                  | Operating: 5% to 85%<br>Storage: 5% to 95%  |
| Vibration resistance      |                  | Destruction: 20 to 2,000 Hz (peak acceleration: 100 m/s <sup>2</sup> )<br>1.5-mm double amplitude for 2 h (4-min periods) each in X, Y, and Z directions  |
| Shock resistance          |                  | Destruction: 500m/s <sup>2</sup> for 3 times each in X, Y, and Z directions   |
| Degree of protection      |                  | IEC IP50  |
| Connecting method         |                  | Special connector (direct soldering possible)   |
| Weight                    |                  | Approx. 3.5 g (including screwdriver for adjustment)  |
| Material                  | Case             | Polybutylene phthalate (PBT)  |
|                           | Emitter/receiver | Polycarbonate   |
| Accessories               |                  | Screwdriver for adjustment  |

\*1. The indicator is a GaP red LED (peak wavelength: 690 nm).

\*2. The response frequency was measured by detecting the following rotating disk.

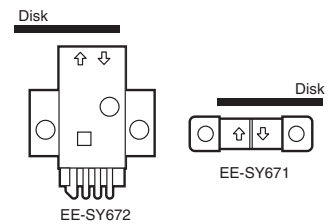
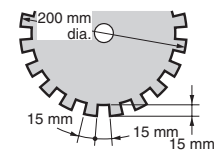

\*3. The ambient illuminance is measured on the surface of the receiver.

## Engineering Data (Typical)

### Operating Range Characteristics (Max. Sensitivity)

EE-SY67□

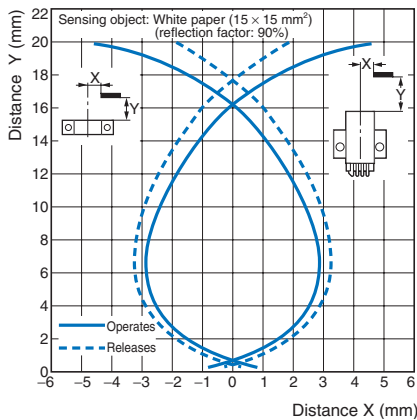

EE-SY67□

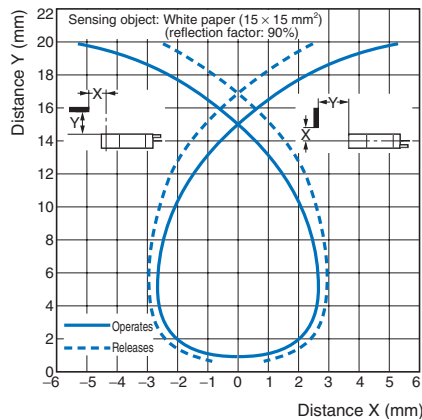

### Sensing Distance vs. Object Area Characteristics

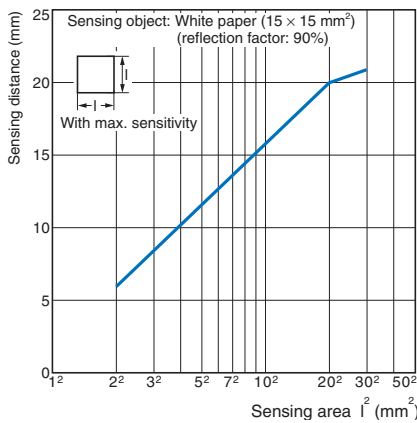

### Sensing Distance vs. Sensitivity Volume

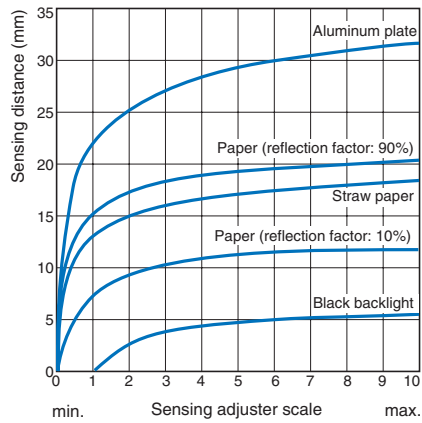

## I/O Circuit Diagrams

### NPN Output

| Model                | Output configuration | Timing charts  | Terminal connections   | Output circuit |
|----------------------|----------------------|--|--|----------------|
| EE-SY671<br>EE-SY672 | Light-ON             | Incident Interrupted<br>Light indicator (red) ON OFF<br>Output transistor ON OFF<br>Load 1 (relay) Operates Releases | Short-circuited between<br>⓪ terminal and positive<br>⊕ terminal |                |
|                      | Dark-ON              | Incident Interrupted<br>Light indicator (red) ON OFF<br>Output transistor ON OFF<br>Load 1 (relay) Operates Releases | Open between<br>⓪ terminal and positive<br>⊕ terminal            |                |

## Safety Precautions

Refer to *Warranty and Limitations of Liability*.

**⚠ WARNING**

This product is not designed or rated for ensuring safety of persons either directly or indirectly. Do not use it for such purposes.



**Precautions for Correct Use**

Make sure that this product is used within the rated ambient environment conditions.

● **Wiring**

**Soldering**

- When direct soldering to the terminal, use the following guidelines.

**Soldering Conditions**

| Item           | Temperature | Permissible time | Remarks  |
|----------------|-------------|------------------|--|
| Soldering iron | 350°C max.  | 3 s max.         | The portion between the base of the terminals and the position 1.5 mm from the terminal base must not be soldered. |

- The terminal base uses a polycarbonate resin, which could be deformed by excessive soldering heat, resulting in damage to the product's functionality.

**Cable Extension**

- When extending the cable, use an extension cable with conductors having a total cross-section area of 0.3 mm<sup>2</sup>. The total cable length must be less than 10 m.

● **Installation**

The photomicrosensor is built into the device being used and so is not equipped to deal with interference from an external light source. When using the sensor in an area exposed to an incandescent lamp, install so as to minimize the effects of external light sources.

● **Sensitivity Adjustment**

Use the special screwdriver (sold together) for sensitivity adjustment.

- When an excessive force is applied to sensitivity adjuster, it may be damaged.
- The shaft of the sensitivity adjuster is charged. Connect a DC power supply incorporating an insulated transformer to the photomicrosensor. Do not connect a DC power supply incorporating an autotransformer or the user may receive an electric shock when adjusting the sensitivity.

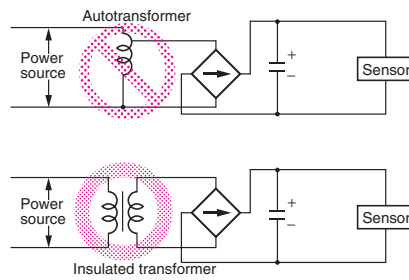

**Sensitivity Adjustment with Background Object**

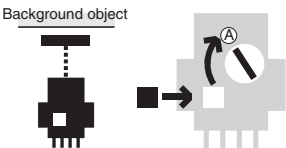
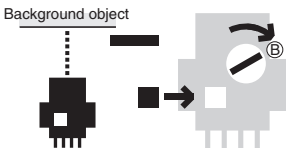
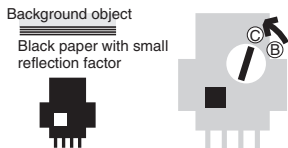
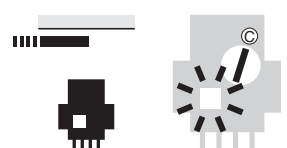
|                    |                    | Point A  | Point B   | Setting  | Check  |
|--------------------|--------------------|--|---|--|--|
| Sensing conditions | Adjuster indicator |   |    |    |   |
|                    |                    | <p>1. Set the sensitivity of the photomicrosensor to minimum, place the sensing object in the sensing position, turn the sensitivity adjuster clockwise slowly until the light indicator is lit (point A).</p> | <p>2. Remove the sensing object, at which time the light indicator will be OFF. Further turn the sensitivity adjuster clockwise slowly until the light indicator is lit again (point B). The operation indicator will not light again if the background object does not reflect light, in which case refer to "Sensitivity Adjustment with No Background Object".</p> | <p>3. Set the sensitivity adjuster at the center (point C) between point A and B. Points A and B will be very close if the sensor is influenced by excessive light reflected by the background object, in which case take the following preventive measures.</p> <ul style="list-style-type: none"> <li>(1) Separate the sensor and the background object by a distance of 20 mm min.</li> <li>(2) Cover the surface of the background object with a material with a small reflection factor, such as black sponge.</li> </ul> | <p>4. After setting the sensitivity adjuster to point C, check if the light indicator is lit on placing the sensing object at the sensing position and not lit on removing the sensing object.</p> |

**Sensitivity Adjustment with No Background Object**

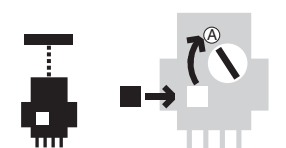
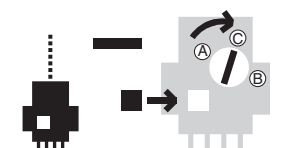
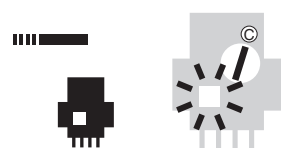
|                    |                    | Point A  | Point B   | Check  |
|--------------------|--------------------|--|---|--|
| Sensing conditions | Adjuster indicator |    |   |   |
|                    |                    | <p>1. Set the sensitivity of the photomicrosensor to minimum, place the sensing object at the sensing position, turn the sensitivity adjuster clockwise slowly until the light indicator is lit (point A).</p> | <p>2. Set the sensitivity adjuster at the center (point C) between points A and B (the point where the sensitivity is maximum).</p> | <p>3. After setting the sensitivity adjuster to point C, check if the light indicator is not lit on removing the sensing object.</p> |

## Dimensions

Tolerance class IT16 applies to dimensions in this datasheet unless otherwise specified.

### Sensors

#### EE-SY671

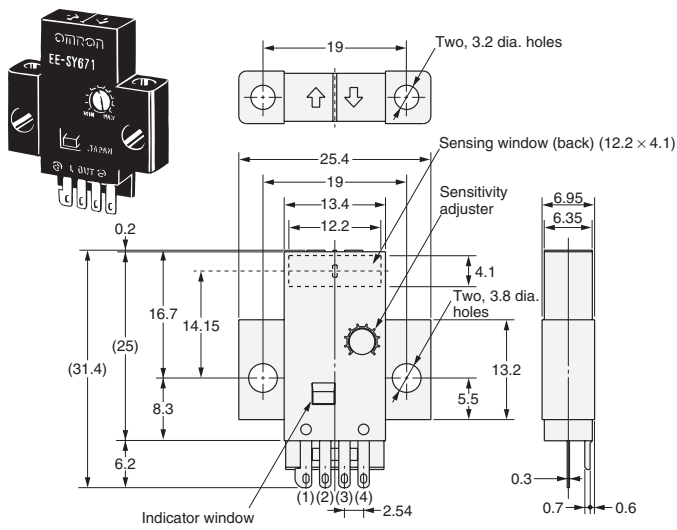

#### Terminal Arrangement

|     |     |           |
|-----|-----|-----------|
| (1) | +   | Vcc       |
| (2) | L   | L         |
| (3) | OUT | OUTPUT    |
| (4) | -   | GND (0 V) |

#### EE-SY672

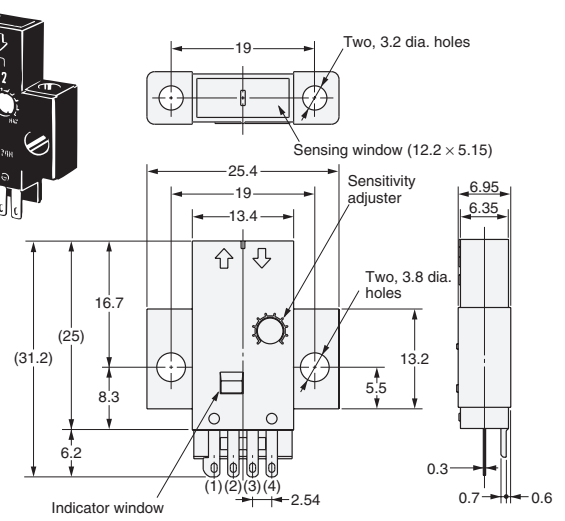

#### Terminal Arrangement

|     |     |           |
|-----|-----|-----------|
| (1) | +   | Vcc       |
| (2) | L   | L         |
| (3) | OUT | OUTPUT    |
| (4) | -   | GND (0 V) |

### Accessories (Order Separately)

\* Refer to *Accessories* for details.

## Read and Understand This Catalog

Please read and understand this catalog before purchasing the products. Please consult your OMRON representative if you have any questions or comments.

## Warranty and Limitations of Liability

### WARRANTY

OMRON's exclusive warranty is that the products are free from defects in materials and workmanship for a period of one year (or other period if specified) from date of sale by OMRON.

OMRON MAKES NO WARRANTY OR REPRESENTATION, EXPRESS OR IMPLIED, REGARDING NON-INFRINGEMENT, MERCHANTABILITY, OR FITNESS FOR PARTICULAR PURPOSE OF THE PRODUCTS. ANY BUYER OR USER ACKNOWLEDGES THAT THE BUYER OR USER ALONE HAS DETERMINED THAT THE PRODUCTS WILL SUITABLY MEET THE REQUIREMENTS OF THEIR INTENDED USE. OMRON DISCLAIMS ALL OTHER WARRANTIES, EXPRESS OR IMPLIED.

### LIMITATIONS OF LIABILITY

OMRON SHALL NOT BE RESPONSIBLE FOR SPECIAL, INDIRECT, OR CONSEQUENTIAL DAMAGES, LOSS OF PROFITS OR COMMERCIAL LOSS IN ANY WAY CONNECTED WITH THE PRODUCTS, WHETHER SUCH CLAIM IS BASED ON CONTRACT, WARRANTY, NEGLIGENCE, OR STRICT LIABILITY.

In no event shall the responsibility of OMRON for any act exceed the individual price of the product on which liability is asserted.

IN NO EVENT SHALL OMRON BE RESPONSIBLE FOR WARRANTY, REPAIR, OR OTHER CLAIMS REGARDING THE PRODUCTS UNLESS OMRON'S ANALYSIS CONFIRMS THAT THE PRODUCTS WERE PROPERLY HANDLED, STORED, INSTALLED, AND MAINTAINED AND NOT SUBJECT TO CONTAMINATION, ABUSE, MISUSE, OR INAPPROPRIATE MODIFICATION OR REPAIR.

## Application Considerations

### SUITABILITY FOR USE

OMRON shall not be responsible for conformity with any standards, codes, or regulations that apply to the combination of products in the customer's application or use of the products.

At the customer's request, OMRON will provide applicable third party certification documents identifying ratings and limitations of use that apply to the products. This information by itself is not sufficient for a complete determination of the suitability of the products in combination with the end product, machine, system, or other application or use.

The following are some examples of applications for which particular attention must be given. This is not intended to be an exhaustive list of all possible uses of the products, nor is it intended to imply that the uses listed may be suitable for the products:

- Outdoor use, uses involving potential chemical contamination or electrical interference, or conditions or uses not described in this catalog.
- Nuclear energy control systems, combustion systems, railroad systems, aviation systems, medical equipment, amusement machines, vehicles, safety equipment, and installations subject to separate industry or government regulations.
- Systems, machines, and equipment that could present a risk to life or property.

Please know and observe all prohibitions of use applicable to the products.

NEVER USE THE PRODUCTS FOR AN APPLICATION INVOLVING SERIOUS RISK TO LIFE OR PROPERTY WITHOUT ENSURING THAT THE SYSTEM AS A WHOLE HAS BEEN DESIGNED TO ADDRESS THE RISKS, AND THAT THE OMRON PRODUCTS ARE PROPERLY RATED AND INSTALLED FOR THE INTENDED USE WITHIN THE OVERALL EQUIPMENT OR SYSTEM.

### PROGRAMMABLE PRODUCTS

OMRON shall not be responsible for the user's programming of a programmable product, or any consequence thereof.

## Disclaimers

### CHANGE IN SPECIFICATIONS

Product specifications and accessories may be changed at any time based on improvements and other reasons.

It is our practice to change model numbers when published ratings or features are changed, or when significant construction changes are made. However, some specifications of the products may be changed without any notice. When in doubt, special model numbers may be assigned to fix or establish key specifications for your application on your request. Please consult with your OMRON representative at any time to confirm actual specifications of purchased products.

### DIMENSIONS AND WEIGHTS

Dimensions and weights are nominal and are not to be used for manufacturing purposes, even when tolerances are shown.

### PERFORMANCE DATA

Performance data given in this catalog is provided as a guide for the user in determining suitability and does not constitute a warranty. It may represent the result of OMRON's test conditions, and the users must correlate it to actual application requirements. Actual performance is subject to the OMRON Warranty and Limitations of Liability.

### ERRORS AND OMISSIONS

The information in this document has been carefully checked and is believed to be accurate; however, no responsibility is assumed for clerical, typographical, or proofreading errors, or omissions.

2008.11

In the interest of product improvement, specifications are subject to change without notice.

**OMRON Corporation**  
Industrial Automation Company

<http://www.ia.omron.com/>

(c)Copyright OMRON Corporation 2008 All Right Reserved.

Компания «Океан Электроники» предлагает заключение долгосрочных отношений при поставках импортных электронных компонентов на взаимовыгодных условиях!

Наши преимущества:

- Поставка оригинальных импортных электронных компонентов напрямую с производств Америки, Европы и Азии, а так же с крупнейших складов мира;
- Широкая линейка поставок активных и пассивных импортных электронных компонентов (более 30 млн. наименований);
- Поставка сложных, дефицитных, либо снятых с производства позиций;
- Оперативные сроки поставки под заказ (от 5 рабочих дней);
- Экспресс доставка в любую точку России;
- Помощь Конструкторского Отдела и консультации квалифицированных инженеров;
- Техническая поддержка проекта, помощь в подборе аналогов, поставка прототипов;
- Поставка электронных компонентов под контролем ВП;
- Система менеджмента качества сертифицирована по Международному стандарту ISO 9001;
- При необходимости вся продукция военного и аэрокосмического назначения проходит испытания и сертификацию в лаборатории (по согласованию с заказчиком);
- Поставка специализированных компонентов военного и аэрокосмического уровня качества (Xilinx, Altera, Analog Devices, Intersil, Interpoint, Microsemi, Actel, Aeroflex, Peregrine, VPT, Syfer, Eurofarad, Texas Instruments, MS Kennedy, Miteq, Cobham, E2V, MA-COM, Hittite, Mini-Circuits, General Dynamics и др.);

Компания «Океан Электроники» является официальным дистрибьютором и эксклюзивным представителем в России одного из крупнейших производителей разъемов военного и аэрокосмического назначения «JONHON», а так же официальным дистрибьютором и эксклюзивным представителем в России производителя высокотехнологичных и надежных решений для передачи СВЧ сигналов «FORSTAR».



## JONHON

«JONHON» (основан в 1970 г.)

Разъемы специального, военного и аэрокосмического назначения:

(Применяются в военной, авиационной, аэрокосмической, морской, железнодорожной, горно- и нефтедобывающей отраслях промышленности)

«FORSTAR» (основан в 1998 г.)

ВЧ соединители, коаксиальные кабели,  
кабельные сборки и микроволновые компоненты:

(Применяются в телекоммуникациях гражданского и специального назначения, в средствах связи, РЛС, а так же военной, авиационной и аэрокосмической отраслях промышленности).



Телефон: 8 (812) 309-75-97 (многоканальный)

Факс: 8 (812) 320-03-32

Электронная почта: [ocean@oceanchips.ru](mailto:ocean@oceanchips.ru)

Web: <http://oceanchips.ru/>

Адрес: 198099, г. Санкт-Петербург, ул. Калинина, д. 2, корп. 4, лит. А