

ATC 400 Z Series Precision Tolerance NPO RF Microwave Capacitors

- EIA Case Size 0201
- Capacitance Range 0.1 pF to 22 pF
- Tolerances to ± 0.02 pF
- Ultra Stable Performance
- RoHS Compliant / Lead-Free

ATC's new 400Z Series Precision Tolerance, Thin Film, NPO RF Microwave Capacitor is manufactured with the highest quality materials to provide reliable and repeatable performance. The 400Z is constructed with a low loss silicon dioxide and silicon oxynitride dielectric along with high quality sputtered electrode materials to ensure superior performance.

High electrical and thermal conductivity and high stability over temperature make this device suitable for a variety of critical small and large signal RF and microwave applications. This Series offers the tightest tolerances available over a wide range of capacitance values.

The 400Z is built in an 0201 SMT package and is fully compatible with high speed automated pick-and-place manufacturing. It is designed to meet the most stringent RF and Microwave requirements.

Typical applications: Filter Networks, Matching Networks, High Q Frequency Sources, Tuning, Coupling, Bypass and DC Blocking.

ENVIRONMENTAL TESTS

LIFE TEST:

MIL-STD-202F, Method 108A, for 1000 hours, at 125°C.
200% WVDC applied.

ACCELERATED DAMP HEAT STEADY STATE

MIL-STD-202, Method 106: 85°C, 85% RH, at rated WVDC, 1000 hours

TEMPERATURE CYCLING

MIL-STD-202F METHOD 107E: -55°C to +125°C, 15 cycles

RESISTANCE TO SOLDER HEAT IEC-68-2-58:

260°C ± 5 °C for 10 secs.

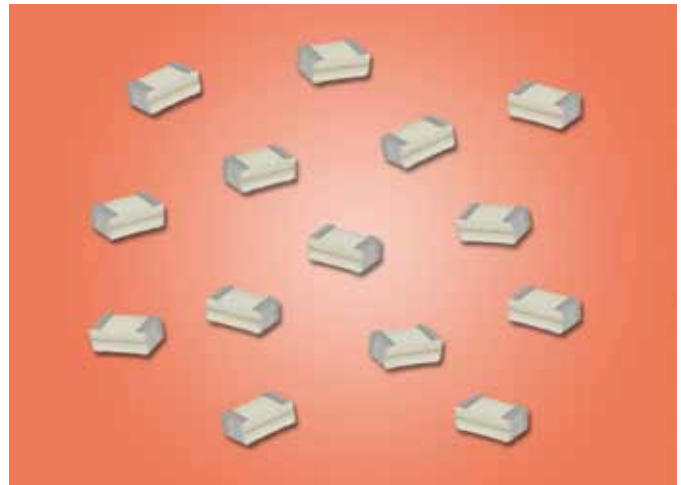

ELECTRICAL AND MECHANICAL SPECIFICATIONS

TEMPERATURE COEFFICIENT OF CAPACITANCE (TCC):

0 ± 30 PPM/°C (-55°C to +125°C) 0.1 to 3.9 pF
0 ± 60 PPM/°C (-55°C to +125°C) 4.0 to 22 pF

INSULATION RESISTANCE (IR):

10⁴ Megohms min. @ +25°C at rated WVDC

WORKING VOLTAGE (WVDC):

See Capacitance Values Table, page 2

DIELECTRIC WITHSTANDING VOLTAGE (DWV):

250% of rated WVDC for 5 secs

AGING EFFECTS: None

DIELECTRIC ABSORPTION: 0.01%

SOLDERABILITY, IEC-68-2-58: Components completely immersed in a solder bath at 235°C for 2 secs.

LEACH RESISTANCE, IEC-68-2-58: Components completely immersed in a solder bath at 260 ± 5 °C for 60 secs.

ADHESION, MIL-STD-202F, METHOD 211A: a force of 1.1 lbs. applied for 10 secs.

OPERATING TEMPERATURE RANGE:

From -55°C to +125°C (No derating of working voltage)

TERMINAL STRENGTH IEC-68-2-21, AMEND. 2: a force of 1.1 lbs. applied for 10 secs.

STORAGE: 12 months minimum with components stored in "as received" packaging



AMERICAN
ATC North America
sales@atceramics.com

TECHNICAL
ATC Europe
sales@atceramics.com

CERAMICS
ATC Asia
sales@atceramics-asia.com

THE ENGINEERS' CHOICE®
ISO 9001 REGISTERED
COMPANY

THE ENGINEERS' CHOICE™

www.atceramics.com

ATC 400 Z Capacitance Values

CAP CODE	CAP (pF)	TOL.	RATED WVDC	CAP CODE	CAP (pF)	TOL.	RATED WVDC	CAP CODE	CAP (pF)	TOL.	RATED WVDC		
0R1	0.1		100	2R3	2.3	Q, A, B, C		4R5	4.5	A, B, C			
0R2	0.2			2R4	2.4			4R6	4.6				
0R3	0.3			2R5	2.5			4R7	4.7				
0R4	0.4			2R6	2.6			5R1	5.1				
0R5	0.5			2R7	2.7			5R6	5.6				
0R6	0.6	P, Q, A, B	50	2R8	2.8	A, B, C	25	6R2	6.2	B, C			
0R7	0.7			2R9	2.9			6R8	6.8				
0R8	0.8			3R0	3.0			7R5	7.5				
0R9	0.9			3R1	3.1			8R2	8.2				
1R0	1.0			3R2	3.2			9R1	9.1				
1R1	1.1			3R3	3.3			100	10			F, G, J	16
1R2	1.2			3R4	3.4			110	11				
1R3	1.3			3R5	3.5			120	12				
1R4	1.4			3R6	3.6			130	13				
1R5	1.5			3R7	3.7			140	14				
1R6	1.6	3R8	3.8	150	15								
1R7	1.7	3R9	3.9	160	16								
1R8	1.8	4R0	4.0	170	17								
1R9	1.9	4R1	4.1	180	18								
2R0	2.0	Q, A, B, C	25	4R2	4.2	190	19						
2R1	2.1			4R3	4.3	200	20	10					
2R2	2.2			4R4	4.4	210	21						
						220	22						

VRMS = 0.707 X WVDC

ATC PART NUMBER CODE

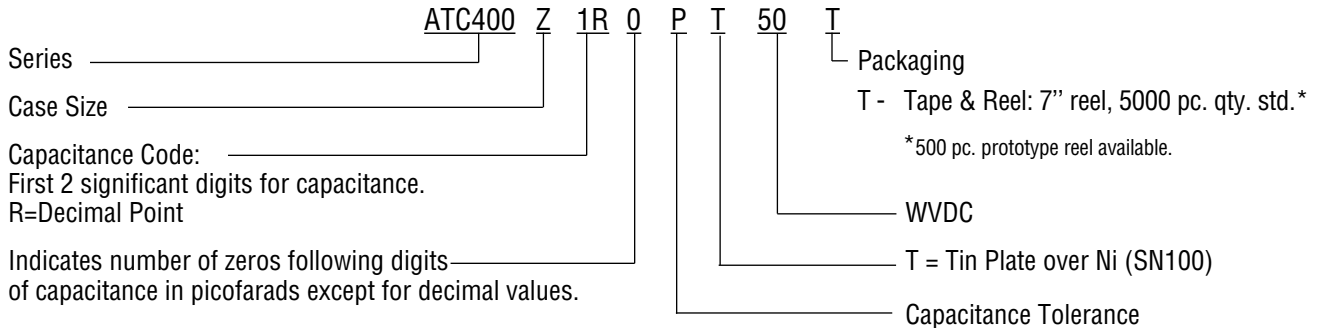

CAPACITANCE TOLERANCE								
Code	P	Q	A	B	C	F	G	J
Tol.	±0.02 pF	±0.03 pF	±0.05 pF	±0.1 pF	±0.25 pF	±1%	±2%	±5%

The above part number refers to a 400 Z Series (0201) 1 pF capacitor, P tolerance (±0.02 pF), 50 WVDC, with T termination (Tin Plated over Nickel Barrier Termination), RoHS Compliant), and tape and reel packaging.

ATC accepts orders for our parts using designations *with* or *without* the "ATC" prefix. Both methods of defining the part number are equivalent, i.e., part numbers referenced with the "ATC" prefix are interchangeable to parts referenced without the "ATC" prefix. Customers are free to use either in specifying or procuring parts from American Technical Ceramics.

For additional information and catalogs contact your ATC representative or call direct at (+1-631) 622-4700.
Consult factory for additional performance data.

Mechanical Dimensions

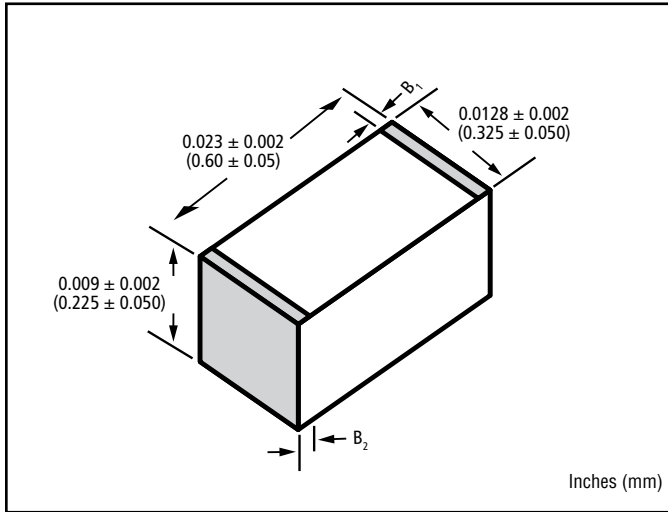

Outline Dimensions

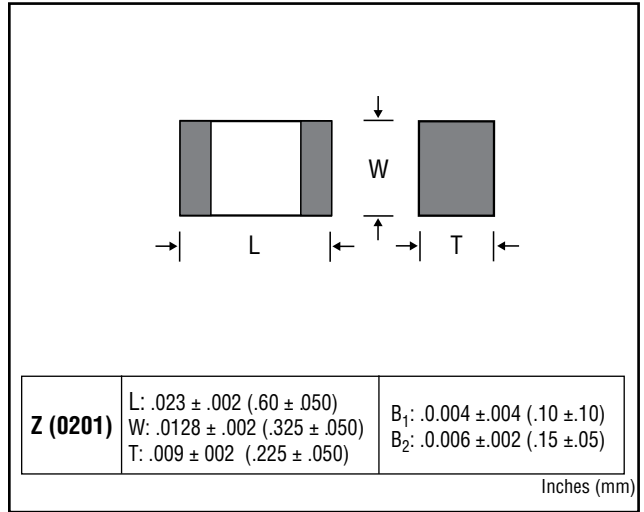

Suggested Mounting Pad Dimensions

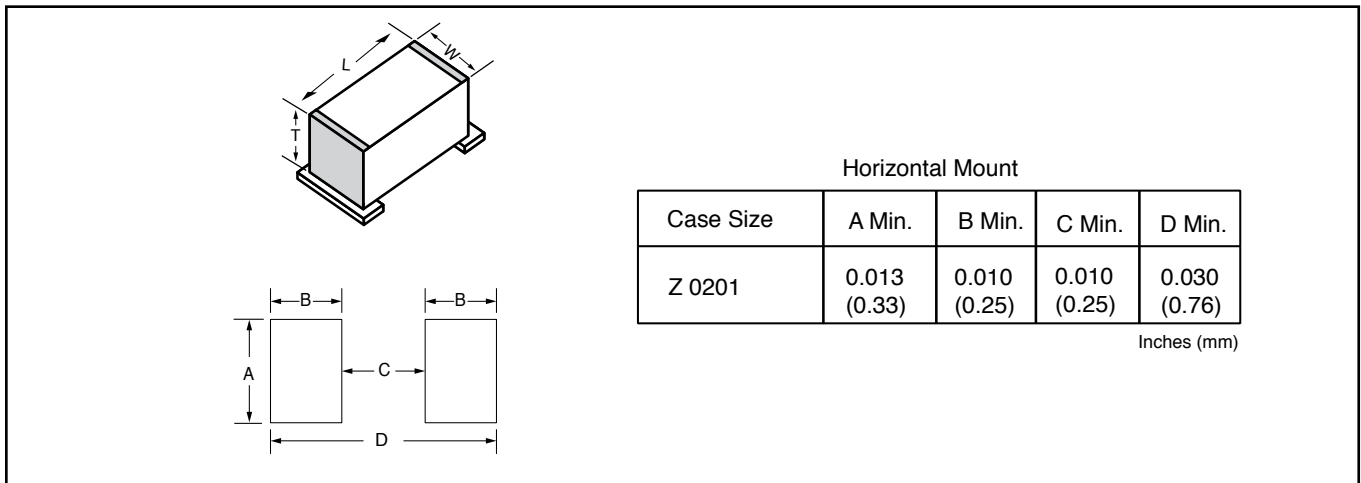

Sales of ATC products are subject to the terms and conditions contained in American Technical Ceramics Corp. Terms and Conditions of Sale (ATC document #001-992 Rev. B; 12/05). Copies of these terms and conditions will be provided upon request. They may also be viewed on ATC's website at www.atceramics.com/productfinder/default.asp. Click on the link for Terms and Conditions of Sale.

ATC has made every effort to have this information as accurate as possible. However, no responsibility is assumed by ATC for its use, nor for any infringements of rights of third parties which may result from its use. ATC reserves the right to revise the content or modify its product without prior notice.

© 2006 American Technical Ceramics Corp. All Rights Reserved

ATC # 001-1124 Rev. E, 5/15

A M E R I C A N T E C H N I C A L C E R A M I C S

ATC North America
sales@atceramics.com

ATC Europe
saleseur@atceramics.com

ATC Asia
sales@atceramics-asia.com

www.atceramics.com

ATC 400 Z Performance Data

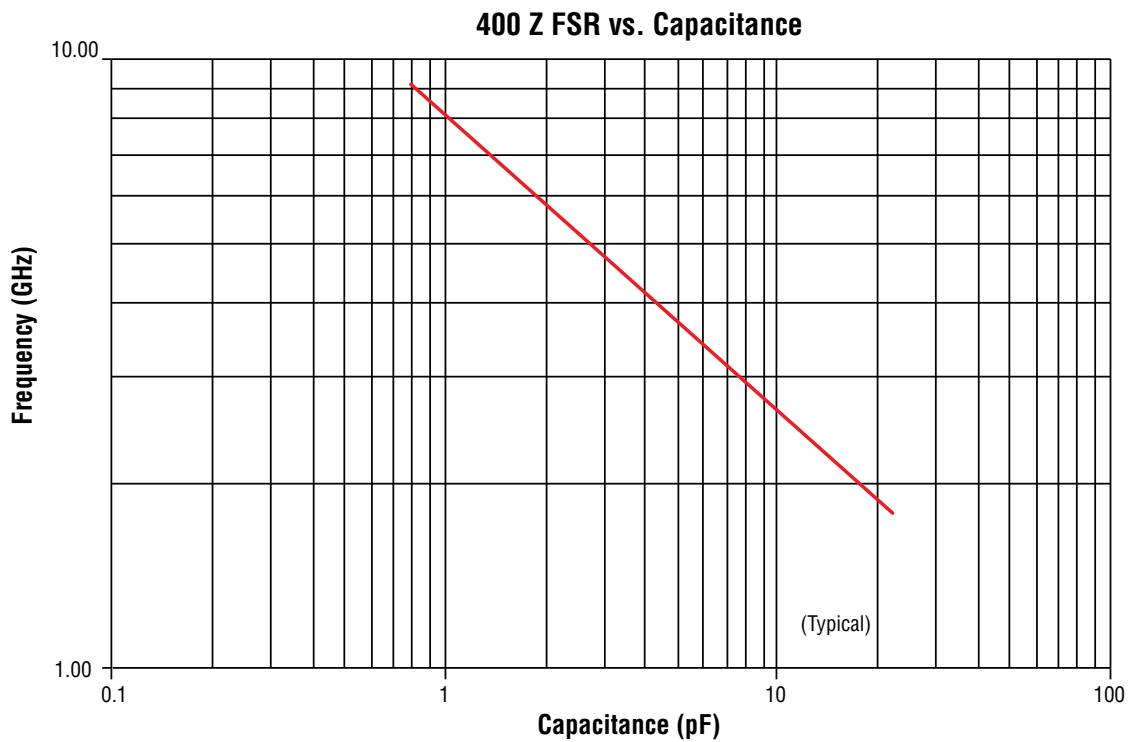
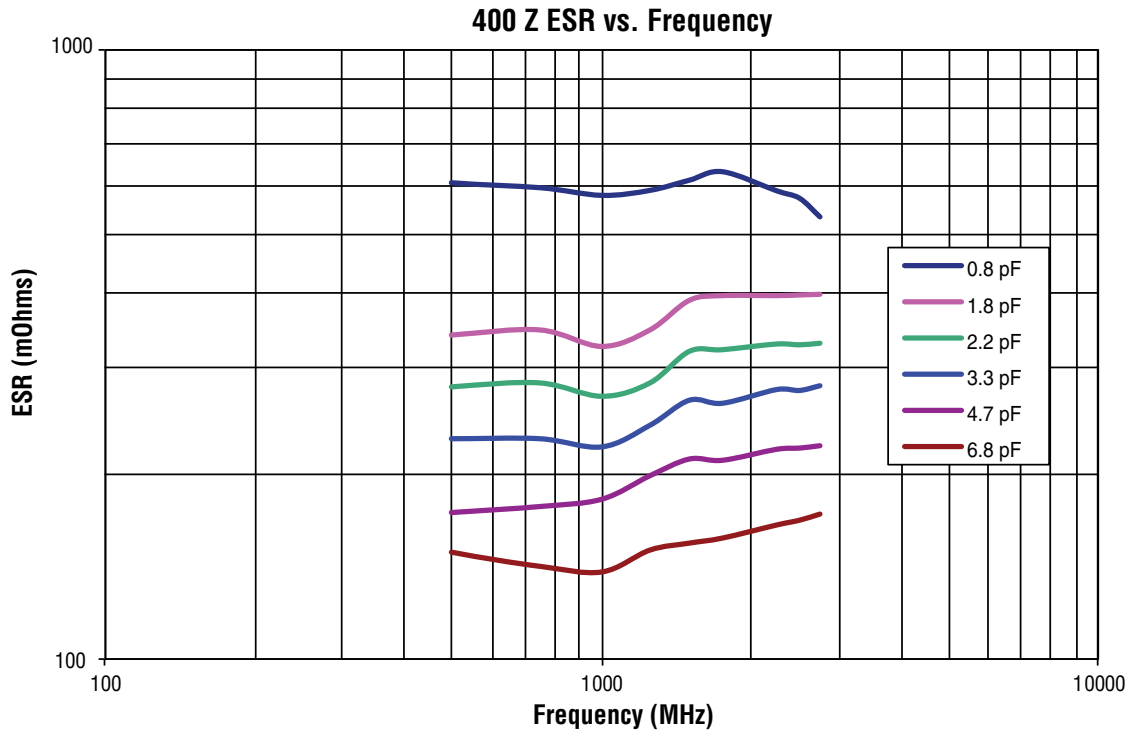

A M E R I C A N T E C H N I C A L C E R A M I C S

ATC North America
sales@atceramics.com

ATC Europe
saleseur@atceramics.com

ATC Asia
sales@atceramics-asia.com

Mouser Electronics

Authorized Distributor

Click to View Pricing, Inventory, Delivery & Lifecycle Information:

American Technical Ceramics (ATC):

[400Z1R8QT25T](#) [400Z0R2AT100T](#) [400Z0R8PT50T](#) [400Z2R5AT25T](#) [400Z2R7AT25T](#) [400Z0R9AT50T](#)
[400Z2R6QT25T](#) [400Z0R4PT100T](#) [400Z0R3QT100T](#) [400Z9R1BT16T](#) [400Z200FT10T](#) [400Z0R7PT50T](#)
[400Z6R8BT25T](#) [400Z2R2AT25T](#) [400Z4R1AT25T](#) [400Z0R5QT100T](#) [400Z1R7QT50T](#) [400Z140FT16T](#)
[400Z3R7AT25T](#) [400Z3R6AT25T](#) [400Z160FT16T](#) [400Z2R9QT25T](#) [400Z2R0QT25T](#) [400Z1R5PT50T](#) [400Z3R4AT25T](#)
[400Z3R9AT25T](#) [400Z4R4AT25T](#) [400Z2R4QT25T](#) [400Z2R8QT25T](#) [400Z0R5AT100T](#) [400Z1R2AT50T](#)
[400Z1R6PT50T](#) [400Z1R3AT50T](#) [400Z1R7AT50T](#) [400Z0R8QT50T](#) [400Z2R8AT25T](#) [400Z0R3AT100T](#)
[400Z110FT16T](#) [400Z4R7AT25T](#) [400Z0R1PT100T](#) [400Z3R8AT25T](#) [400Z1R0AT50T](#) [400Z5R6BT25T](#)
[400Z0R7AT50T](#) [400Z0R6AT50T](#) [400Z1R2PT50T](#) [400Z130FT16T](#) [400Z210FT10T](#) [400Z2R1AT25T](#) [400Z1R1QT50T](#)
[400Z1R3PT50T](#) [400Z1R4PT50T](#) [400Z1R3QT50T](#) [400Z1R9AT25T](#) [400Z1R7PT50T](#) [400Z0R2PT100T](#)
[400Z1R1PT50T](#) [400Z1R9QT25T](#) [400Z3R3AT25T](#) [400Z220FT10T](#) [400Z2R9AT25T](#) [400Z2R2QT25T](#) [400Z190FT16T](#)
[400Z1R6AT50T](#) [400Z1R6QT50T](#) [400Z0R4AT100T](#) [400Z1R5QT50T](#) [400Z1R4AT50T](#) [400Z0R1QT100T](#)
[400Z2R7QT25T](#) [400Z1R5AT50T](#) [400Z3R0AT25T](#) [400Z0R9QT50T](#) [400Z1R0PT50T](#) [400Z120FT16T](#) [400Z3R5AT25T](#)
[400Z6R2BT25T](#) [400Z2R6AT25T](#) [400Z0R1AT100T](#) [400Z0R8AT50T](#) [400Z0R2QT100T](#) [400Z150FT16T](#)
[400Z2R3AT25T](#) [400Z2R0AT25T](#) [400Z5R1BT25T](#) [400Z0R6PT50T](#) [400Z2R3QT25T](#) [400Z3R1AT25T](#) [400Z7R5BT16T](#)
[400Z4R5AT25T](#) [400Z2R5QT25T](#) [400Z3R2AT25T](#) [400Z0R7QT50T](#) [400Z0R3PT100T](#) [400Z4R0AT25T](#)
[400Z0R4QT100T](#) [400Z1R2QT50T](#) [400Z4R6AT25T](#) [400Z100FT16T](#) [400Z4R3AT25T](#)

Компания «Океан Электроники» предлагает заключение долгосрочных отношений при поставках импортных электронных компонентов на взаимовыгодных условиях!

Наши преимущества:

- Поставка оригинальных импортных электронных компонентов напрямую с производств Америки, Европы и Азии, а так же с крупнейших складов мира;
- Широкая линейка поставок активных и пассивных импортных электронных компонентов (более 30 млн. наименований);
- Поставка сложных, дефицитных, либо снятых с производства позиций;
- Оперативные сроки поставки под заказ (от 5 рабочих дней);
- Экспресс доставка в любую точку России;
- Помощь Конструкторского Отдела и консультации квалифицированных инженеров;
- Техническая поддержка проекта, помощь в подборе аналогов, поставка прототипов;
- Поставка электронных компонентов под контролем ВП;
- Система менеджмента качества сертифицирована по Международному стандарту ISO 9001;
- При необходимости вся продукция военного и аэрокосмического назначения проходит испытания и сертификацию в лаборатории (по согласованию с заказчиком);
- Поставка специализированных компонентов военного и аэрокосмического уровня качества (Xilinx, Altera, Analog Devices, Intersil, Interpoint, Microsemi, Actel, Aeroflex, Peregrine, VPT, Syfer, Eurofarad, Texas Instruments, MS Kennedy, Miteq, Cobham, E2V, MA-COM, Hittite, Mini-Circuits, General Dynamics и др.);

Компания «Океан Электроники» является официальным дистрибьютором и эксклюзивным представителем в России одного из крупнейших производителей разъемов военного и аэрокосмического назначения «JONHON», а так же официальным дистрибьютором и эксклюзивным представителем в России производителя высокотехнологичных и надежных решений для передачи СВЧ сигналов «FORSTAR».



JONHON

«JONHON» (основан в 1970 г.)

Разъемы специального, военного и аэрокосмического назначения:

(Применяются в военной, авиационной, аэрокосмической, морской, железнодорожной, горно- и нефтедобывающей отраслях промышленности)

«FORSTAR» (основан в 1998 г.)

ВЧ соединители, коаксиальные кабели, кабельные сборки и микроволновые компоненты:

(Применяются в телекоммуникациях гражданского и специального назначения, в средствах связи, РЛС, а так же военной, авиационной и аэрокосмической отраслях промышленности).



Телефон: 8 (812) 309-75-97 (многоканальный)

Факс: 8 (812) 320-03-32

Электронная почта: ocean@oceanchips.ru

Web: <http://oceanchips.ru/>

Адрес: 198099, г. Санкт-Петербург, ул. Калинина, д. 2, корп. 4, лит. А