

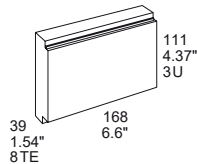


MELCHER™
The Power Partners.

M Series 50 Watt DC-DC and AC-DC Converters

Features

- Extremely wide operating input voltage ranges from 8 to 385 VDC and 85 to 264 VAC, 47 to 440 Hz
- RoHS lead-free-solder and lead-solder-exempted products available
- Class I equipment
- Input over- and undervoltage lockout
- 1, 2, or 3 individually isolated outputs up to 72 V
- Outputs: SELV, no load, overload, short-circuit proof, rectangular current limiting characteristic
- Adjustable output voltages with remote on/off
- Immunity according to IEC/EN 61000-4-2, -3, -4, -5, -6
- Emissions according to EN 55011/55022
- According to EN 45545 and NF-F-16 (Version V107 or later)
- All PCBs boards coated by protective lacquer
- Very high reliability
- Battery charger models available



Safety-approved to the latest edition of IEC/EN 60950-1 and UL/CSA 60950-1



Table of Contents

| | | | |
|-----------------------------|----|---|----|
| Description..... | 2 | Electromagnetic Compatibility (EMC)..... | 15 |
| Model Selection..... | 2 | Immunity to Environmental Conditions..... | 17 |
| Functional Description..... | 5 | Mechanical Data..... | 19 |
| Electrical Input Data..... | 6 | Safety and Installation Instructions..... | 20 |
| Electrical Output Data..... | 8 | Description of Options..... | 23 |
| Auxiliary Functions..... | 12 | Accessories..... | 30 |

Description

The M Series of DC-DC and AC-DC converters represents a broad and flexible range of power supplies for use in advanced industrial electronic systems. Features include high efficiency, reliability, low output voltage noise and excellent dynamic response to load/line changes due to individual regulation of each output.

The converter inputs are protected against surges and transients occurring at the source lines. An input over- and undervoltage lockout circuit disables the outputs, if the input voltage is outside the specified range. An inrush current limitation prevents circuit breakers and fuses from tripping at switch-on.

All outputs are open- and short-circuit proof, and are protected against overvoltages by means of built-in suppressor diodes. The outputs can be inhibited by a logic signal applied to the connector (pin 2). If the inhibit function is not used, pin 2 should be connected to pin 23 to enable the outputs.

LED indicators display the status of the converter and allow visual monitoring of the system at any time.

Full input to output, input to case, output to case, and output to output isolation is provided.

The case design allows operation at nominal load up to 71 °C in a free-air ambient temperature. If forced cooling is provided, the ambient temperature may exceed 71 °C but the case temperature should remain below 95 °C under all conditions.

A temperature sensor generates an inhibit signal, which disables the outputs, when the case temperature TC exceeds the limit. The outputs automatically recover, when the temperature drops below the limit.

Various options are available to adapt the converters to individual applications.

The converters may either be plugged into a 19" rack system according to IEC 60927-3 or be mounted onto a chassis or a plate.

Model Selection

Non-standard input/output configurations or special custom adaptations are available on request. Table 1 provides an overview of the basic input and output configurations. More than 1000 different model types have been manufactured with different input/output configurations and customized specialties. Please consult the company for additional model types.

Table 1a: Standard models AM, BM, FM

| Output 1 | | Output 2 | | Output 3 | | Operating Input Voltage Range and Efficiency ¹ | | | | | Options | |
|-----------------------|---------------------|-----------------------|---------------------|-----------------------|---------------------|---|-----------------------|--|-----------------------|---|-----------------------|------------------------|
| $V_{o\ nom}$ [VDC] | $I_{o\ nom}$ [A] | $V_{o\ nom}$ [VDC] | $I_{o\ nom}$ [A] | $V_{o\ nom}$ [VDC] | $I_{o\ nom}$ [A] | $V_{i\ min} - V_{i\ max}$ 8 - 35 VDC | $\eta_{\ min}$ [%] | $V_{i\ min} - V_{i\ max}$ 14 - 70 VDC | $\eta_{\ min}$ [%] | $V_{i\ min} - V_{i\ max}$ 20 - 100 VDC | $\eta_{\ min}$ [%] | |
| 5.1 | 8.0 | - | - | - | - | AM1001-9RG | 72 | BM1001-9RG | 74 | FM1001-9RG | 74 | -7, P, |
| 12 | 4.0 | - | - | - | - | AM1301-9RG | 79 | BM1301-9RG | 80 | FM1301-9RG | 80 | D0 - D9, |
| 15 | 3.4 | - | - | - | - | AM1501-9RG | 79 | BM1501-9RG | 81 | FM1501-9RG | 81 | V0 - V3 ² , |
| 24 | 2.0 | - | - | - | - | AM1601-9RG | 81 | BM1601-9RG | 83 | FM1601-9RG | 82 | F, A, K, H, |
| 48 | 1.0 | - | - | - | - | AM1901-9RG | 81 | BM1901-9RG | 83 | FM1901-9RG | 83 | non-G |
| 5.1 | 4.0 | 5.1 | 4.0 | - | - | AM2001-9G | - | BM2001-9G | - | - | - | -7, P, |
| 5.1 | 4.0 | 24 | 1.0 | - | - | AM2060-9G | - | BM2060-9G | - | - | - | D0 - D9, |
| 12 | 2.0 | 12 | 2.0 | - | - | AM2320-9G | 77 | BM2320-9G | 79 | FM2320-9G | 80 | A, K, H, |
| 15 | 1.7 | 15 | 1.7 | - | - | AM2540-9G | 78 | BM2540-9G | 80 | FM2540-9G | 79 | non-G |
| 24 | 1.0 | 24 | 1.0 | - | - | AM2660-9G | - | BM2660-9G | - | - | - | |
| 5.1 | 5.0 | 12 | 0.7 | 12 | 0.7 | AM3020-9G | 75 | BM3020-9G | 76 | FM3020-9G | 76 | -7, P, |
| 5.1 | 5.0 | 15 | 0.6 | 15 | 0.6 | AM3040-9G | 75 | BM3040-9G | 76 | FM3040-9G | 76 | D0 - D9, |
| 5.1 | 5.0 | 24 | 0.35 | 24 | 0.35 | AM3060-9G | - | BM3060-9G | - | - | - | A, K, H, |
| | | | | | | | | | | | | non-G |

¹ Min. efficiency at $V_{i\ nom}$ and $I_{o\ nom}$. Typ. values are approx. 2% better.

² Option V0, V2, V3 available only for output 1 = 5.1 V (excludes option D)

 NFND: Not for new designs.

 Preferred for new designs

Table 1b: Models CM, DM, LM

| Output 1 | | Output 2 | | Output 3 | | Operating Input Voltage Range and Efficiency ¹ | | | | | Options | |
|-----------------------|---------------------|-----------------------|---------------------|-----------------------|---------------------|---|---------------------|---|---------------------|--|---------------------|-------------------------|
| $V_{o\ nom}$ [VDC] | $I_{o\ nom}$ [A] | $V_{o\ nom}$ [VDC] | $I_{o\ nom}$ [A] | $V_{o\ nom}$ [VDC] | $I_{o\ nom}$ [A] | $V_{i\ min} - V_{i\ max}$ 28 - 140 VDC | η_{min} [%] | $V_{i\ min} - V_{i\ max}$ 44 - 220 VDC | η_{min} [%] | $V_{i\ min} - V_{i\ max}$ 88 - 372 VDC 85 - 264 VAC ³ | η_{min} [%] | |
| 5.1 | 8.0 | - | - | - | - | CM1001-9RG | 74 | DM1001-9RG | 74 | LM1001-9RG | 74 | -7, E ⁴ , P, |
| 12 | 4.0 | - | - | - | - | CM1301-9RG | 80 | DM1301-9RG | 81 | LM1301-9RG | 80 | D0 - D9, |
| 15 | 3.4 | - | - | - | - | CM1501-9RG | 82 | DM1501-9RG | 82 | LM1501-9RG | 79 | V0 - V3 ² , |
| 24 | 2.0 | - | - | - | - | CM1601-9RG | 82 | DM1601-9RG | - | LM1601-9RG | 82 | A, K, H, |
| 48 | 1.0 | - | - | - | - | CM1901-9RG | 82 | DM1901-9RG | 83 | LM1901-9RG | 82 | non-G |
| 5.1 | 4.0 | 5.1 | 4.0 | - | - | CM2001-9G | - | DM2001-9G | - | LM2001-9G | - | -7, E ⁴ , P, |
| 5.1 | 4.0 | 24 | 1.0 | - | - | CM2060-9G | - | DM2060-9G | - | LM2060-9G | - | D0 - D9, |
| 12 | 2.0 | 12 | 2.0 | - | - | CM2320-9G | 79 | DM2320-9G | 80 | LM2320-9G | 80 | A, K, H, |
| 15 | 1.7 | 15 | 1.7 | - | - | CM2540-9G | 80 | DM2540-9G | 80 | LM2540-9G | 79 | non-G |
| 24 | 1.0 | 24 | 1.0 | - | - | CM2660-9G | - | DM2660-9G | - | LM2660-9G | - | |
| 5.1 | 5.0 | 12 | 0.7 | 12 | 0.7 | CM3020-9G | 76 | DM3020-9G | 77 | LM3020-9G | 74 | -7, E ⁴ , P, |
| 5.1 | 5.0 | 15 | 0.6 | 15 | 0.6 | CM3040-9G | 76 | DM3040-9G | 76 | LM3040-9G | 73 | D0 - D9, |
| 5.1 | 5.0 | 24 | 0.35 | 24 | 0.35 | CM3060-9G | 76 | DM3060-9G | 76 | LM3060-9G | - | A, K, H, |
| | | | | | | | | | | | | non-G |

Table 1c: EM and battery charger models

| Output 1 | | | | Output 2 | | Output 3 | | Operating Input Voltage Range & Efficiency ¹ | | | | Options |
|--|---------------------|-------------------------------------|-----------------------|-----------------------|---------------------|-----------------------|---------------------|---|---------------------|--|---------------------|--------------|
| $V_{o\ nom}$ ⁵ [VDC] | $I_{o\ nom}$ [A] | $V_{o\ safe}$ ⁶ [VDC] | $V_{o\ max}$ [VDC] | $V_{o\ nom}$ [VDC] | $I_{o\ nom}$ [A] | $V_{o\ nom}$ [VDC] | $I_{o\ nom}$ [A] | $V_{i\ min} - V_{i\ max}$ 67 - 385 VDC | η_{min} [%] | $V_{i\ min} - V_{i\ max}$ 88 - 372 VDC 85 - 264 VAC ³ | η_{min} [%] | |
| Same $V_{o\ nom}$ and $I_{o\ nom}$ as DM models | - | - | - | - | - | - | - | EM1xxx-9RG | - | - | - | -7, E, D, A, |
| | | | | Same as DM models | | | | EM2xxx-9RG | - | - | - | non-G |
| | | | | Same as DM models | | Same as DM models | | EM3xxx-9RG | - | - | - | |
| 12 | 3.6 | 12.84 | 14.15 – 14.60 | - | - | - | - | - | - | LM1781-9RD5G | 79 | |
| 24 | 1.8 | 25.68 | 28.30 – 29.15 | - | - | - | - | - | - | LM1782-9RD5G | 81 | |
| 36 | 1.2 | 38.52 | 42.45 – 43.72 | - | - | - | - | - | - | LM1783-9RD5G | 82 | -7, E, A, |
| 48 | 0.9 | 51.36 | 56.60 – 58.30 | - | - | - | - | - | - | LM1784-9RD5G | 81 | non-G |
| 60 | 0.72 | 64.20 | 70.75 – 72.87 | - | - | - | - | - | - | LM1785-9RD5G | 81 | |

- ¹ Min. efficiency at $V_{i\ nom}$ and $I_{o\ nom}$. Typ. values are approx. 2% better.
² Option V0, V2, V3 available only for output 1 = 5.1 V (excludes option D)
³ Operating frequency range: 47 – 440 Hz; see *Safety and Installation Instructions* for > 60 Hz !
⁴ Option E only available for CM and LM models (not for DM)
⁵ $V_{o\ nom}$ for EM models
⁶ Setting voltage with open R-input (battery chargers)

NFND: Not for new designs. Preferred for new designs

Part Number Description

C M 2 5 40 -9 E P D3 A H G

| | | | |
|---|----------------------------------|----------------|--|
| Operating input range V_i : | 8 – 35 VDC | A | |
| | 14 – 70 VDC | B | |
| | 20 – 100 VDC | F | |
| | 28 – 140 VDC | C | |
| | 44 – 220 VDC | D | |
| | 67 – 385 VDC | E | |
| | 85 – 264 VAC, 88 – 372 VDC | L | |
| Series | | M | |
| Number of outputs ⁴ | 1, 2, 3 ⁴ | | |
| Output 1, $V_{o1\text{ nom}}$: | 5.1 V | 0, 1, 2 | |
| | 12 V | 3 | |
| | 15 V | 4, 5 | |
| | 24 V | 6 | |
| | other voltages | 7, 8 | |
| | 48 V | 9 | |
| Single-output models (different specs.) | | 01 – 99 | |
| Outputs 2, 3: $V_{o2\text{ nom}}$, $V_{o3\text{ nom}}$: | 5.1 V | 01 – 19 | |
| | 12 V | 20 – 39 | |
| | 15 V | 40 – 59 | |
| | 24 V | 60 – 69 | |
| | other voltages and specs. | 21 – 99 | |
| Ambient temperature range T_A : | -25 to 71 °C | -7 | |
| | -40 to 71 °C | -9 | |
| | customer-specific | -0, -5, -6, -8 | |
| Auxiliary functions and options: | | | |
| Inrush current limitation (CM, EM, LM) | | E | |
| Output voltage control input (single-output models) | | R ² | |
| Potentiometers for adjustment of output voltages | | P ² | |
| Save data signal (D0 – D9, to be specified) | | D ¹ | |
| ACFAIL signal (V0, V2, V3, to be specified) | | V ¹ | |
| Output voltage test sockets | | A | |
| Increased electric strength test voltage | | H | |
| Input fuse built-in (not accessible) | | F ³ | |
| Coding strip at the connector | | K | |
| RoHS-compliant for all 6 substances | | G | |

¹ Option D excludes option V and vice versa

² Feature R is fitted to single-output models only. Option P excludes option R (and vice versa).

³ Only for FM1000

⁴ Models with 220 mm case length. Just add 6000 to the standard model number, e.g., DM3020-9AG → DM9020-9AG.

Note: The sequence of options must follow the order above. The part number description is descriptive only; it is not intended for creating part numbers.

Example: CM2540-9EPD3AHG: DC-DC converter, operating input voltage range 28 – 140 VDC, providing output 1 with 15 V/1.7 A and output 2 with 15 V/1.7 A; temperature range -40 to +71 °C, inrush current limitation, equipped with potentiometers, undervoltage monitor D3, test sockets, tested with higher voltage output to case, RoHS-compliant for all 6 substances.

Product Marking

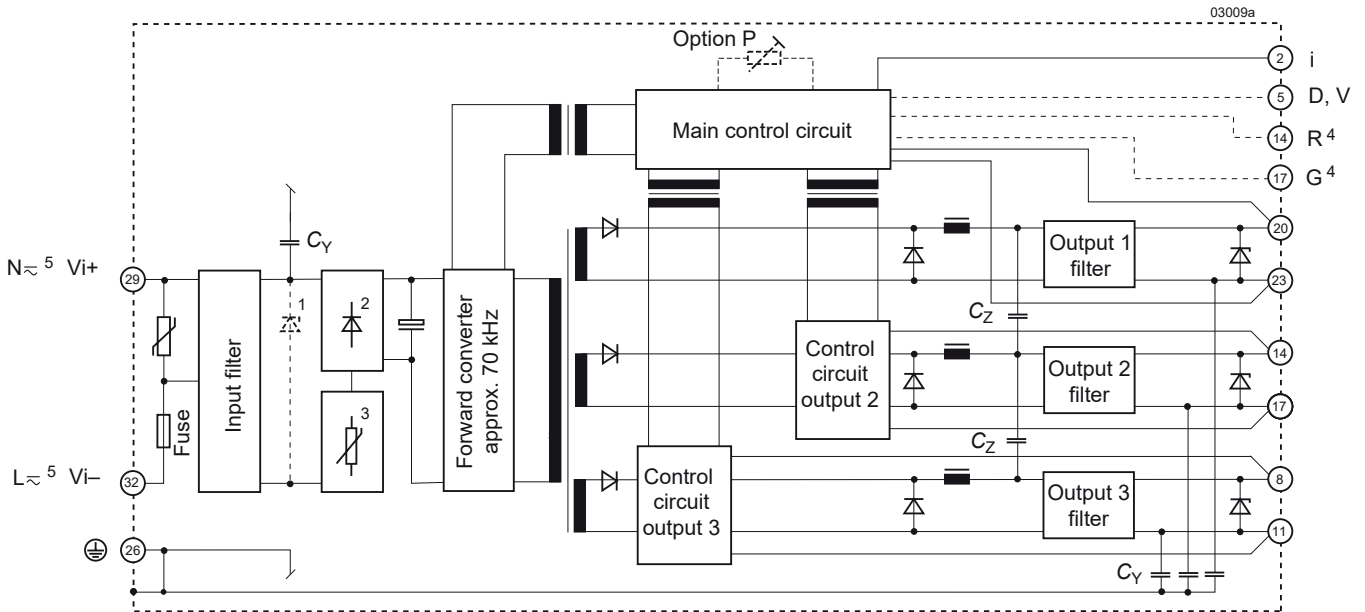
Basic type designation, applicable approval marks, CE mark, warnings, pin designation, patents and company logo, identification of LEDs, test sockets, and potentiometer.

Specific type designation, input voltage range, nominal output voltages and currents, degree of protection, batch no., serial no., and data code including production site, modification status (version), and date of production.

Functional Description

The input voltage is fed via an input fuse, an input filter, a bridge rectifier, and an inrush current limiter to the input capacitor. This capacitor sources a single-transistor forward converter. Each output is powered by a separate secondary winding of the main transformer. The resultant voltages are rectified and their ripple smoothed by a power choke and an output filter. The main control circuit senses the main output voltage V_{o1} and generates, with respect to the maximum admissible output currents, the control signal for the primary switching transistor. This signal is transferred to the primary side by a coupling transformer.

The auxiliary output voltages V_{o2} and V_{o3} are individually regulated by means of secondary switching transistors. Each auxiliary output's current is sensed using a current transformer. If one of the outputs is driven into current limit, the other outputs will reduce their output voltages as well, because all output currents are controlled by the same main control circuit.



- 1 Transient suppressor diode in AM, BM, CM, FM models.
- 2 Bridge rectifier in LM, series diode in EM models.
- 3 Inrush current limiter (NTC) in CM, DM, EM, LM models (option E: refer to the description of option E).
- 4 Single-output models with feature R.
- 5 LM-models

Fig. 1
Block diagram, triple-output models

Electrical Input Data

General conditions:

- $T_A = 25\text{ °C}$, unless T_C is specified.
- Connector pins 2 and 23 interconnected, R input not connected; with option P: $V_o = V_{o\text{ nom}}$

Table 2a: Input data

| Model | | | AM | | | BM | | | FM | | | CM | | | Unit |
|-----------------------|--|--|------|-----|------|-----|-----|------|-----|-----|-----|------------------|-----|------------------|------|
| Characteristics | | Conditions | min | typ | max | min | typ | max | min | typ | max | min | typ | max | |
| V_i | Operating input voltage | $I_o = 0 - I_{o\text{ nom}}$ | 8 | | 35 | 14 | | 70 | 20 | | 100 | 28 | | 154 ⁷ | VDC |
| $V_{i\text{ nom}}$ | Nominal input voltage | $T_{C\text{ min}} - T_{C\text{ max}}$ | | 15 | | | 30 | | | 50 | | | 60 | | |
| I_i | Input current | $V_{i\text{ nom}}, I_{o\text{ nom}}^2$ | | 4.0 | | | 2.0 | | | 1.2 | | | 1.0 | | A |
| P_{i0} | No-load input power: – single-output models – double-output models – triple-output models | $V_{i\text{ nom}}, I_{o1,2,3} = 0$ | | 1 | 1.5 | | 1 | 1.5 | | 1 | 1.5 | | 1 | 1.5 | W |
| | | | | 7 | 9 | | 7 | 9 | | 7 | 9 | | 7 | 9 | |
| | | | | 6 | 9 | | 6 | 9 | | 6 | 9 | | 6 | 9 | |
| $P_{i\text{ inh}}$ | Idle input power | Inhibited $V_{i\text{ nom}}$ | | 1 | 1.5 | | 1 | 1.5 | | 1 | 1.5 | | 1 | 1.5 | |
| $I_{i\text{ nr p}}^6$ | Peak inrush current | $V_i = V_{i\text{ max}}$ | | | 400 | | | 500 | | | 400 | | | 170 ⁴ | |
| $t_{i\text{ nr r}}$ | Rise time | $R_S = 0\ \Omega^3$ | | 60 | | | 50 | | | 40 | | | 60 | | |
| $t_{i\text{ nr h}}$ | Time to half-value | $T_C = 25\text{ °C}$ | | 170 | | | 100 | | | 60 | | | 280 | | |
| R_i | Input resistance | $T_C = 25\text{ °C}$ | 87.5 | | | 140 | | | 250 | | | 824 ⁴ | | | mΩ |
| C_i | Input capacitance | | 2600 | | 4000 | 670 | | 1100 | 370 | | 600 | 370 | | 600 | μF |
| $V_{i\text{ abs}}$ | Input voltage limits without any damage | | 0 | | 40 | 0 | | 80 | 0 | | 120 | 0 | | 160 | VDC |

Table 2b: Input data

| Model | | | DM | | | EM | | | LM | | | Unit | | | |
|-----------------------|--|--|-------------------|------|------------------|-------------------|-------|------------------|-------------------|-----|-----------------|------|-----|-----|-----|
| Characteristics | | Conditions | min | typ | max | min | typ | max | min | typ | max | | | | |
| V_i | Operating input voltage | $I_o = 0 - I_{o\text{ nom}}$ | | - | | | - | | 85 | | 264 | VDC | | | |
| | | | | 44 | | 220 | 67 | | 385 | 88 | | | 372 | | |
| $V_{i\text{ nom}}$ | Nominal input voltage | $T_{C\text{ min}} - T_{C\text{ max}}$ | | 110 | | | 220 | | | 310 | | | | | |
| I_i | Input current | $V_{i\text{ nom}}, I_{o\text{ nom}}^2$ | | 0.55 | | | 0.275 | | | 0.2 | | | A | | |
| P_{i0} | No-load input power: – single-output models – double-output models – triple-output models | $V_{i\text{ nom}}, I_{o1,2,3} = 0$ | | 1 | 1.5 | | 1 | 1.5 | | 1 | 1.5 | | 1 | 1.5 | W |
| | | | | 7 | 9 | | 7 | 9 | | 7 | 9 | | 7 | 9 | |
| | | | | 6 | 9 | | 6 | 9 | | 6 | 9 | | 6 | 9 | |
| $P_{i\text{ inh}}$ | Idle input power | Inhibited $V_{i\text{ nom}}$ | | 1 | 1.5 | | 1 | 1.5 | | 1 | 1.5 | | 1 | 1.5 | |
| $I_{i\text{ nr p}}^6$ | Peak inrush current | $V_i = V_{i\text{ max}}$ | | | 110 ⁴ | | | 160 ⁴ | | | 60 ⁴ | | | | |
| $t_{i\text{ nr r}}$ | Rise time | $R_S = 0\ \Omega^3$ | | 40 | | | 40 | | | 300 | | | | | |
| $t_{i\text{ nr h}}$ | Time to half-value | $T_C = 25\text{ °C}$ | | 250 | | | 240 | | | 900 | | | | | |
| R_i | Input resistance | $T_C = 25\text{ °C}$ | 2000 ⁴ | | | 2400 ⁴ | | | 6200 ⁴ | | | | | | mΩ |
| C_i | Input capacitance | | 140 | | 270 | 140 | | 270 | 140 | | 270 | 140 | | 270 | μF |
| $V_{i\text{ abs}}$ | Input voltage limits without any damage | | 0 | | 400 ⁵ | -400 | | 400 | -400 | | 400 | 0 | | 284 | VDC |
| | | | - | | - | - | | - | - | | - | | - | | |

¹ In AC powered mode (LM models): Nominal input voltage range: 100 – 240 VAC, operating input frequency range: 47 – 440 Hz

² With multiple-output models, the same condition for each output applies.

³ R_S = source resistance.

⁴ Value for initial switch-on cycle.

⁵ 1 s max., duty cycle 1% max.

⁶ $I_{i\text{ nr p}} = V_i / (R_S + R_i)$; see *Inrush Current*.

⁷ 140 V continuously. CM models with version V106 or greater (or with suffix /131) withstand 154 V for 2 s.

Input Fuse

A fuse holder containing a slow-blow type fuse (size: 5 × 20 mm) is mounted in the back plate of the converter. The fuse protects the converter against severe defects. It may not fully protect it at input voltages exceeding 200 VDC. In applications, where the converters operate at DC source voltages above 200 VDC, an external fuse or a circuit breaker at system level should be installed. The fuse and a VDR form together with the input filter an effective protection against high input transients.

Note: For applications, where the fuse should not be accessible; see *Option F*.

Table 3: Fuse types (slow-blow)

| Series | Schurter type | Part number |
|---|--------------------|-------------|
| AM1000 – 3000 | SPT 10 A / 250 V | 0001.2514 |
| BM1000 – 3000 | SPT 8 A / 250 V | 0001.2513 |
| FM1000 – 3000 | SPT 5 A / 250 V | 0001.2511 |
| CM1000 – 3000 | SPT 3.15 A / 250 V | 0001.2509 |
| DM1000 – 3000 EM1000 – 3000 LM1000 – 3000 | SPT 2.5 A / 250 V | 0001.2508 |



Fig. 2
Typical input current versus relative input voltage at nominal output load

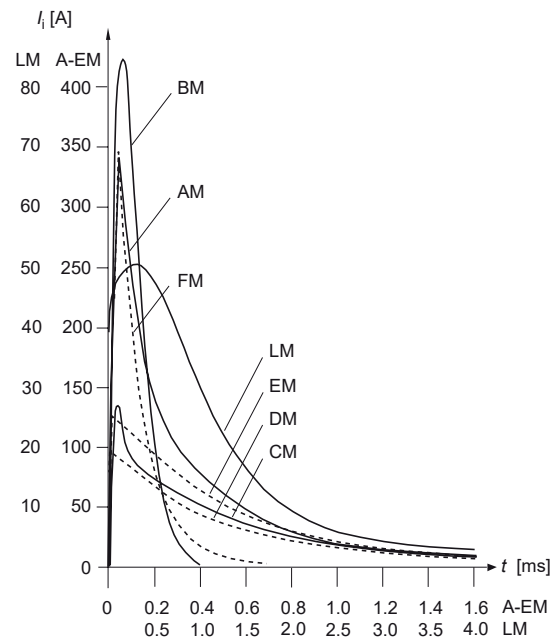


Fig. 3
Typical inrush current at initial switch-on. $V_{i,max}$ (DC) and nominal output load

Inrush Current

The CM, DM, EM, and LM (excluding FM) models incorporate an NTC resistor in the input line, which (during the initial switch-on cycle) limits the peak inrush current in order to prevent the connectors and external switching devices from damage. Subsequent switch-on cycles within a short interval will cause an increase of the peak inrush current due to the warming-up of the NTC resistor. Refer to *Option E* (only available for CM, EM, and LM).

Input Under-/Overvoltage Lockout

If the input voltage remains below $0.8 V_{i,min}$ or exceeds approx. $1.1 V_{i,max}$, an internally generated inhibit signal disables the output(s). When checking this function the absolute maximum input voltage rating $V_{i,abs}$ must be carefully considered (see table *Input data*).

Note: When V_i is between $V_{i,min}$ and the undervoltage lockout level, the output voltage may be below the value defined in table *Output data*.

Reverse Polarity

Reverse polarity at the input of AM, BM, CM, DM, and FM models will cause the fuse to blow. In EM and LM models a series diode will protect the converter. A series diode is not incorporated in AM, BM, CM, DM and FM types to avoid unwanted power losses.

Electrical Output Data

General Conditions:

- $T_A = 25\text{ °C}$, unless T_C is specified.
- Connector pins 2 and 23 interconnected, R input not connected; with option P: $V_o = V_{o, \text{nom}}$

Table 4: Output data

| Output voltage | | | 5.1 V | | | 12 V | | | 15 V | | | 24 V | | | 48 V | | | Unit | | | | | | | |
|---------------------|--|---|--|------|----------|-------|------------|-------|----------|-----|------------|-------|----------|-------|------------|-----|----------|------|------------|---|----------|--|------|--|------------------|
| Characteristics | | Conditions | min | typ | max | min | typ | max | min | typ | max | min | typ | max | min | typ | max | | | | | | | | |
| V_o | Output voltage | $V_{I, \text{nom}}^1 I_{o, \text{nom}}^1$ | 5.07 | | 5.13 | 11.93 | | 12.07 | 14.91 | | 15.09 | 23.86 | | 24.14 | 47.72 | | 48.28 | V | | | | | | | |
| $V_{o, p}$ | Output overvoltage protection ⁵ | | 7.5 | | | 21 | | | 25 | | | 41 | | | 85 | | | | | | | | | | |
| $I_{o, \text{nom}}$ | Output current | $V_{I, \text{min}} - V_{I, \text{max}}$ | see Table 1: Model Selection | | | | | | | | | | | | | | | | | | | | | | |
| $I_{o, L}$ | Output current limitation | $T_{C, \text{min}} - T_{C, \text{max}}$ | see Fig. 4: Typical voltage V_o versus output currents I_o | | | | | | | | | | | | | | | | | | | | | | |
| V_o | Output voltage noise | Switching frequ. | $V_{I, \text{nom}}^1 I_{o, \text{nom}}^1$ | | 15 | | 30 | | 25 | | 50 | | 35 | | 70 | | 40 | | 80 | | 50 | | 100 | | mV _{pp} |
| | | Total | IEC/EN 61204 BW = 20 MHz | | 60 | | 120 | | 40 | | 80 | | 40 | | 80 | | 40 | | 80 | | - | | - | | |
| $\Delta V_{o, V}$ | Static line regulation | $V_{I, \text{min}} - V_{I, \text{nom}}$ $V_{I, \text{nom}} - V_{I, \text{max}}$ $I_{o, \text{nom}}^1$ | ± 10 | | ± 30 | | ± 12 | | ± 50 | | ± 15 | | ± 60 | | ± 15 | | ± 60 | | ± 15 | | ± 60 | | mV | | |
| $\Delta V_{o, I}$ | Static load regulation | $V_{I, \text{nom}}$ $I_{o, \text{nom}} - 0^2$ | 6 | | 25 | | 13 | | 50 | | 17 | | 60 | | 30 | | 80 | | 60 | | 150 | | | | |
| $\Delta V_{o, Ic}$ | Static cross load regulation ⁴ | $V_{I, \text{nom}}$ $I_{o, \text{nom}} - 0^3$ | 0 | | ± 15 | | 0 | | ± 20 | | 0 | | ± 30 | | 0 | | ± 40 | | - | | - | | | | |
| $V_{o, d}$ | Dynamic load regulation | Voltage deviation | ± 220 | | | | ± 110 | | | | ± 150 | | | | ± 130 | | | | ± 150 | | | | ms | | |
| t_d | Recovery time | $V_{I, \text{nom}}$ $I_{o, \text{nom}} \leftrightarrow \frac{1}{3} I_{o, \text{nom}}^2$ IEC/EN 61204 | 0.6 | | | | 0.6 | | | | 0.5 | | | | 1 | | | | 2 | | | | | | |
| $V_{o, d, c}$ | Dynamic cross load regulation ⁴ | Voltage deviation | +10 | | | | +10 | | | | +10 | | | | +20 | | | | - | | | | mV | | |
| $t_{d, c}$ | | Recovery time | $V_{I, \text{nom}}$ $I_{o, \text{nom}} \leftrightarrow \frac{1}{3} I_{o, \text{nom}}^3$ IEC/EN 61204 | 0.05 | | | | 0.2 | | | | 0.5 | | | | 1 | | | | - | | | | | |
| α_{V_o} | Temperature coefficient $\Delta V_o / \Delta T_C$ | $V_{I, \text{min}} - V_{I, \text{nom}}$ | ± 0.02 | | | | ± 0.02 | | | | ± 0.02 | | | | ± 0.02 | | | | ± 0.02 | | | | %/K | | |
| | | $0 - I_{o, \text{nom}}$ | ± 1.0 | | | | ± 2.4 | | | | ± 3.0 | | | | ± 4.8 | | | | ± 9.6 | | | | mV/K | | |

¹ With multiple-output models, all outputs are loaded with the nominal current.

² Condition for specified output. With multiple-output models, other output(s) loaded with constant current $I_{o, \text{nom}}$. See fig. 5 *Dynamic load regulation*.

³ Condition for non-specified output, individually tested, other output(s) loaded with constant current $I_{o, \text{nom}}$. See fig. 5 *Dynamic load regulation*.

⁴ Multiple-output models.

⁵ By suppressor diode.

Output Characteristic and Protection

Each output is protected by a suppressor diode, which under worst case conditions may become a short circuit. The suppressor diodes are not designed to withstand externally applied overvoltages. Overload at any of the outputs will cause a shutdown of all outputs. A red LED indicates an overload condition at the respective output.

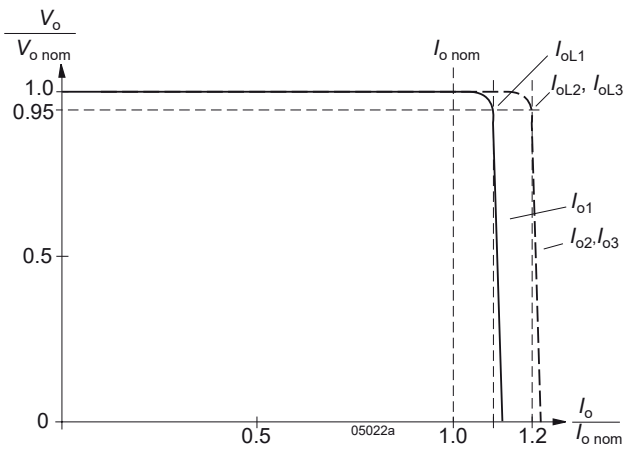


Fig. 4
Typical voltage V_o versus output currents I_o .

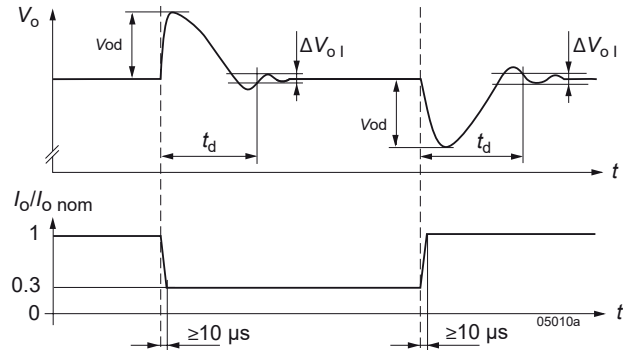


Fig. 5
Dynamic load regulation $V_{o,d}$ versus load change.

Thermal Considerations and Protection

If a converter is located in free, quasi-stationary air (convection cooling) at the indicated maximum ambient temperature $T_{A,max}$ (see table *Temperature specifications*) and is operated at its nominal input voltage and output power, the temperature measured at the measuring point of case temperature T_C (see *Mechanical Data*) will approach the indicated value $T_{C,max}$ after the warm-up phase. However, the relationship between T_A and T_C depends heavily on the conditions of operation and integration into a system. The thermal conditions are influenced by input voltage, output current, airflow, and temperature of surrounding components and surfaces. $T_{A,max}$ is therefore, contrary to $T_{C,max}$, an indicative value only.

Caution: The installer must ensure that under all operating conditions T_C remains within the limits stated in the table *Temperature specifications*.

Notes: Sufficient forced cooling or an additional heat sink allow T_A to pass over 71 °C, if $T_{C,max}$ is not exceeded.

For -7 or -9 models at an ambient temperature T_A of 85 °C with only convection cooling, the maximum permissible current for each output is approx. 50% of its nominal value; see figure 6.

A temperature sensor generates an internal inhibit signal disabling the outputs, when the case temperature exceeds $T_{C,max}$. The outputs automatically recover, when the temperature drops below this limit.

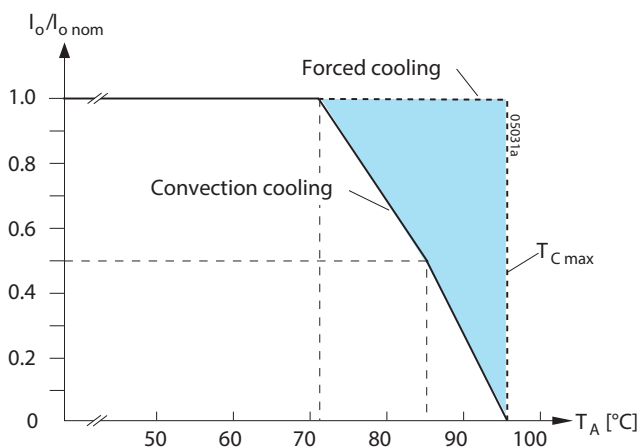


Fig. 6
Output current derating versus temperature

Parallel and Series Connection

Main outputs of equal nominal voltage can be connected in parallel. It is important to assure that the main output of a multiple-output converter is forced to supply a minimum current of 0.1 A to enable correct operation of its own auxiliary outputs.

In parallel operation, one or more of the main outputs may operate continuously in current limitation, causing an increase of the case temperature T_c . Consequently, a reduction of the max. ambient temperature by 10 K is recommended.

Main or auxiliary outputs can be connected in series with any other output of the same or another converter. In series connection, the maximum output current is limited by the lowest current limit. Output ripple and regulation values are added. Connection wiring should be kept as short as possible.

If output terminals are connected together in order to establish multi-voltage configurations, e.g., +5.1 V, ±12 V etc., the common-ground connecting point should be as close as possible to the connectors of the converter in order to avoid excessive output ripple voltages.

Note: Auxiliary outputs should never be connected in parallel!

Output Current Allocation for Special Models

Output currents differing from those given for standard models (see *Model Selection*) can be provided on request. A maximum output power of 50 W should be considered, if an ambient temperature range of –40 to 71 °C is required. The maximum permissible output currents are indicated in the table below. If the output voltages are different from standard values, the relevant output currents have to be adapted accordingly.

With reduced maximum ambient temperature or with forced cooling, the total output power may exceed 50 W. Customized configurations always need to be checked by a feasibility study first. Please ask the Company for more information.

Table 5: Current allocation with special models

| Output voltage all types $V_{o1/2/3 \text{ nom}}$ [V] | Output 1 all types $I_{o1 \text{ max}}$ [A] | Output 2 AM – LM2000 $I_{o2 \text{ max}}$ [A] | Output 2 AM – LM3000 $I_{o2 \text{ max}}$ [A] | Output 3 AM – LM3000 $I_{o3 \text{ max}}$ [A] | Temperature | |
|--|--|--|--|--|-------------|------------|
| | | | | | T_A [°C] | T_c [°C] |
| 5.1 | 8.0 | 4.0 | 1.8 (2.5 ¹) | 1.5 | –40 to 71 | –25 to 95 |
| 12 | 4.0 | 2.0 | 1.5 | 1.2 | | |
| 15 | 3.4 | 1.7 | 1.2 | 1.0 | | |
| 24 | 2.0 | 1.0 | 0.7 | 0.5 | | |
| | | | | | | |
| ² 5.1 | 10.0 | 4.5 | 2.1 (2.8 ¹) | 1.8 | –25 to 60 | –25 to 90 |
| 12 | 5.0 | 2.5 | 1.7 | 1.5 | | |
| 15 | 4.0 | 2.0 | 1.5 | 1.3 | | |
| 24 | 2.5 | 1.3 | 0.9 | 0.7 | | |
| ² 5.1 | 11.0 | 5.0 | 2.4 (3.0 ¹) | 2.0 | –25 to 50 | –25 to 85 |
| 12 | 6.0 | 3.0 | 2.0 | 1.7 | | |
| 15 | 4.6 | 2.3 | 1.7 | 1.5 | | |
| 24 | 3.0 | 1.5 | 1.0 | 0.8 | | |

¹ Special high-current components required.

² $V_{i \text{ min}}$ has to be increased.

Hold-up Time and Output Response

When the input voltage is switched off, the output voltage will remain high for a certain hold-up time t_h (see fig. 7) before the output voltage falls below $0.95 V_{o,nom}$. To achieve the hold-up times indicated in fig. 8, AM, BM, CM, DM, and FM models require an external series diode in the input line. This is necessary to prevent the discharge of the input capacitor through the source impedance or other circuits connected to the same source. EM and LM models have a built-in series diode. In AM, BM, CM, DM, and FM models, no series diode is built-in, since it would generate additional power losses inside the converter.

Note: For hold-up time with option V, refer to *Option V*.

The behavior of the outputs is similar with either the input voltage applied or the inhibit switched low.

No output voltage overshoot occurs, when the converter is turned on or off.

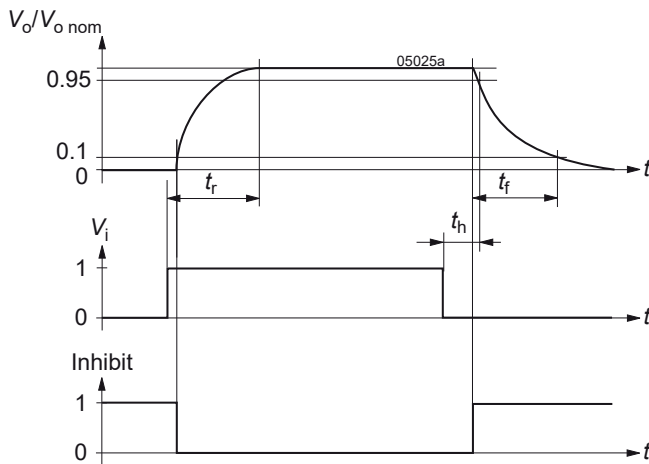


Fig. 7
Output response times versus V_i or inhibit control

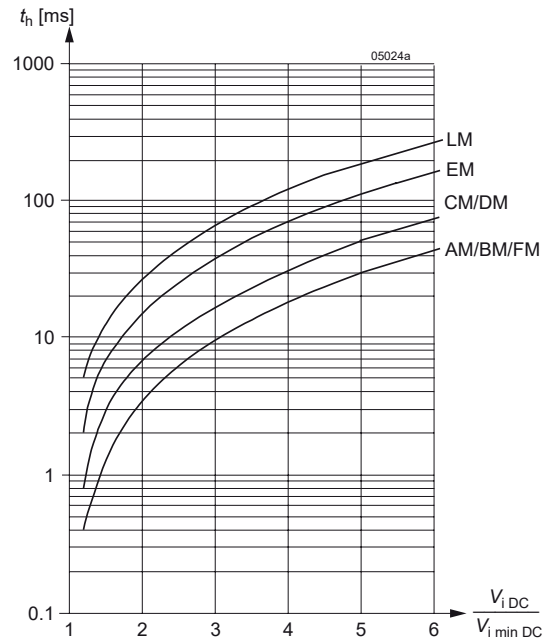


Fig. 8
Typical hold-up time t_h versus input voltage at $I_{o,nom}$

Table 6: Output response time t_r and t_f (see fig. 7). Values not applicable for models equipped with option E.

| Type of converter | t_r at $P_o = 0$ and t_f at $P_o = P_{o,nom}$ | | t_r and t_f at $P_o = \frac{3}{4} P_{o,nom}$ | | t_r and $P_o = P_{o,nom}$ | | Unit |
|-------------------|---|-----|--|-----|-----------------------------|-----|------|
| | typ | max | typ | max | typ | max | |
| AM – LM1001-9R | 5 | 10 | 5 | 10 | 10 | 20 | ms |
| AM – LM1301-9R | 10 | 20 | 15 | 30 | 20 | 30 | |
| AM – LM1501-9R | 5 | 10 | 10 | 20 | 30 | 40 | |
| AM – LM1601-9R | 15 | 30 | 25 | 50 | 40 | 60 | |
| AM – LM1901-9R | 65 | 130 | 100 | 200 | 165 | 330 | |
| AM – LM2320-9 | 20 | 40 | 30 | 60 | 50 | 100 | |
| AM – LM2540-9 | 15 | 30 | 20 | 40 | 35 | 70 | |
| AM – LM3020-9 | 55 | 110 | 85 | 170 | 145 | 290 | |
| AM – LM3040-9 | 40 | 80 | 60 | 120 | 100 | 200 | |

Conditions:

R input not connected. For multiple-output models the figures indicated in the table relate to the output, which reacts slowest. All outputs are resistively loaded. Variation of the input voltage within $V_{i,min} - V_{i,max}$ does not influence the values considerably.

Auxiliary Functions

Inhibit

The outputs of the converters may be enabled or disabled by means of a logic signal (TTL, CMOS, etc.) applied between the inhibit input *i* and the negative pin of output 1 (V_{o1-}). In systems with several converters, this feature can be used, for example, to control the activation sequence of the converters. If the inhibit function is not required, connect the inhibit pin 2 to pin 23 to enable the outputs (active low logic, fail safe). The response times are specified in table 6.

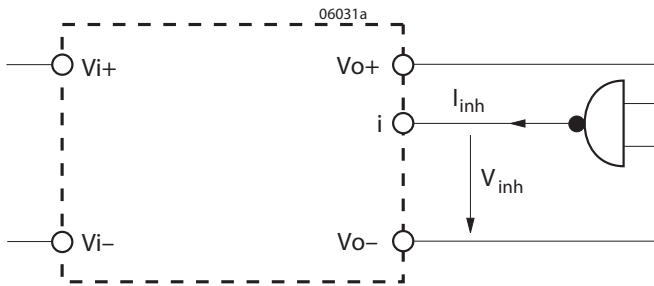


Fig. 9
Definition of V_{inh} and I_{inh} .

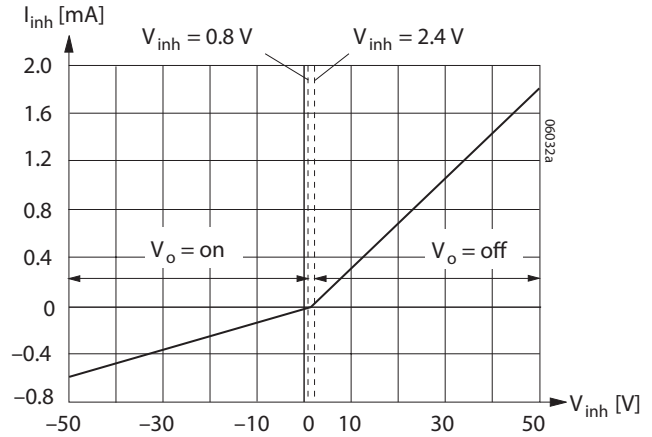


Fig. 9
Definition of V_{inh} and I_{inh} .

Table 7: Inhibit data

| Characteristics | | Conditions | min | typ | max | Unit |
|-----------------|--|--------------------|---------------------------|------|------|---------------|
| V_{inh} | Inhibit input voltage to keep output voltage | $V_o = \text{on}$ | $V_{i \min} - V_{i \max}$ | -50 | 0.8 | V |
| | | $V_o = \text{off}$ | $T_{C \min} - T_{C \max}$ | 2.4 | 50 | |
| I_{inh} | Inhibit current | $V_{inh} = 0$ | -60 | -100 | -220 | μA |

R-Control for Output Voltage Adjustment

As a standard feature, single-output models without option P offer an adjustable output voltage identified by letter R in the type designation.

Note: With open R input, $V_o = V_{o \text{ nom}}$.

The output voltage V_o can either be adjusted by an external voltage (V_{ext}) or by an external resistor (R_{ext1} or R_{ext2}). The adjustment range is approximative 0 – 110% of $V_{o \text{ nom}}$. For output voltages $V_o > V_{o \text{ nom}}$, the minimum input voltage $V_{i \min}$ specified in *Electrical Input Data* increases proportionally to $V_o/V_{o \text{ nom}}$.

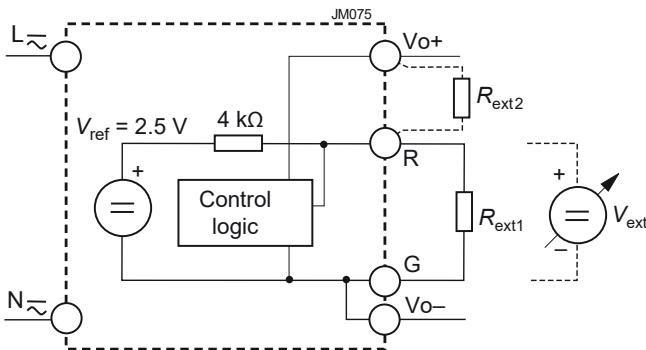


Fig. 11
Output voltage adjustment

a) Adjustment by means of an external resistor R_{ext} .

Depending upon the value of the required output voltage, the resistor shall be connected:

either: Between the R and G pin to achieve an output voltage adjustment range of $V_o \approx 0$ to 100 % of $V_{o\ nom}$.

$$R_{ext1} \approx 4\text{ k}\Omega \cdot \frac{V_o}{V_{o\ nom} - V_o}$$

or: Between the R pin and Vo+ to achieve an output voltage range of $V_o \approx 100$ to 110% of $V_{o\ nom}$.
($V_o - 2.5\text{ V}$)

$$R_{ext2} \approx 4\text{ k}\Omega \cdot \frac{V_o}{2.5\text{ V} \cdot (V_o/V_{o\ nom} - 1)}$$

Caution: To prevent damage, R_{ext2} should never be less than 47 k Ω .

Note: R inputs of n converters with paralleled outputs may be paralleled too, but if only one external resistor is used, its value should be R_{ext1}/n or R_{ext2}/n respectively.

b) Adjustment by means of an external control voltage V_{ext} between G and R pin.

The control voltage range is 0 to 2.75 V and allows for adjustment in the range of $V_o \approx 0$ to 110% of $V_{o\ nom}$.

$$V_{ext} \approx \frac{V_o \cdot 2.5\text{ V}}{V_{o\ nom}}$$

Caution: The external control voltage should be in the range 0 to +3V to prevent the converter from damage.

Table 8a: R_{ext1} for $V_o < V_{o\ nom}$ (Conditions: $V_{i\ nom}$, $I_{o\ nom}$, rounded up to resistor values E 96, R_{ext2} is not fitted.)

| $V_{o\ nom} = 5.1\text{ V}$ | | $V_{o\ nom} = 12\text{ V}$ | | $V_{o\ nom} = 15\text{ V}$ | | $V_{o\ nom} = 24\text{ V}$ | | $V_{o\ nom} = 48\text{ V}$ | |
|-----------------------------|--------------------------|----------------------------|--------------------------|----------------------------|--------------------------|----------------------------|--------------------------|----------------------------|--------------------------|
| V_o [V] | R_{ext1} [k Ω] | V_o [V] | R_{ext1} [k Ω] | V_o [V] | R_{ext1} [k Ω] | V_o [V] | R_{ext1} [k Ω] | V_o [V] | R_{ext1} [k Ω] |
| 0.5 | 0.432 | 2 | 0.806 | 2 | 0.619 | 4 | 0.806 | 8 | 0.806 |
| 1.0 | 0.976 | 3 | 1.33 | 4 | 1.47 | 6 | 1.33 | 12 | 1.33 |
| 1.5 | 1.65 | 4 | 2 | 6 | 2.67 | 8 | 2 | 16 | 2 |
| 2.0 | 2.61 | 5 | 2.87 | 8 | 4.53 | 10 | 2.87 | 20 | 2.87 |
| 2.5 | 3.83 | 6 | 4.02 | 9 | 6.04 | 12 | 4.02 | 24 | 4.02 |
| 3.0 | 5.76 | 7 | 5.62 | 10 | 8.06 | 14 | 5.62 | 28 | 5.62 |
| 3.5 | 8.66 | 8 | 8.06 | 11 | 11 | 16 | 8.06 | 32 | 8.06 |
| 4.0 | 14.7 | 9 | 12.1 | 12 | 16.2 | 18 | 12.1 | 36 | 12.1 |
| 4.5 | 30.1 | 10 | 20 | 13 | 26.1 | 20 | 20 | 40 | 20 |
| 5.0 | 200 | 11 | 44.2 | 14 | 56.2 | 22 | 44.2 | 44 | 44.2 |

Table 8b: R_{ext2} for $V_o > V_{o\ nom}$ (Conditions: $V_{i\ nom}$, $I_{o\ nom}$, rounded up to resistor values E 96, R_{ext1} is not fitted.)

| $V_{o\ nom} = 5.1\text{ V}$ | | $V_{o\ nom} = 12\text{ V}$ | | $V_{o\ nom} = 15\text{ V}$ | | $V_{o\ nom} = 24\text{ V}$ | | $V_{o\ nom} = 48\text{ V}$ | |
|-----------------------------|--------------------------|----------------------------|--------------------------|----------------------------|--------------------------|----------------------------|--------------------------|----------------------------|--------------------------|
| V_o [V] | R_{ext2} [k Ω] | V_o [V] | R_{ext2} [k Ω] | V_o [V] | R_{ext2} [k Ω] | V_o [V] | R_{ext2} [k Ω] | V_o [V] | R_{ext2} [k Ω] |
| 5.15 | 464 | 12.1 | 1780 | 15.2 | 1470 | 24.25 | 3160 | 48.5 | 6810 |
| 5.20 | 215 | 12.2 | 909 | 15.4 | 750 | 24.50 | 1620 | 49.0 | 3480 |
| 5.25 | 147 | 12.3 | 619 | 15.6 | 511 | 24.75 | 1100 | 49.5 | 2370 |
| 5.30 | 110 | 12.4 | 464 | 15.8 | 383 | 25.00 | 825 | 50.0 | 1780 |
| 5.35 | 90.9 | 12.5 | 383 | 16.0 | 332 | 25.25 | 715 | 50.5 | 1470 |
| 5.40 | 78.7 | 12.6 | 316 | 16.2 | 274 | 25.50 | 590 | 51.0 | 1270 |
| 5.45 | 68.1 | 12.7 | 274 | 16.4 | 237 | 25.75 | 511 | 51.5 | 1100 |
| 5.50 | 61.9 | 12.8 | 249 | 16.5 | 226 | 26.00 | 453 | 52.0 | 953 |
| | | 13.0 | 200 | | | 26.25 | 402 | 52.5 | 845 |
| | | 13.2 | 169 | | | 26.40 | 383 | 52.8 | 806 |

Display Status of LEDs



LEDs "OK", "i" and "I_{oL}" status versus input voltage
 Conditions: $I_o \leq I_{o,nom}$, $T_C \leq T_{C,max}$, $V_{inh} \leq 0.8 V$
 V_{i,uv} = undervoltage lock-out, V_{i,ov} = overvoltage lock-out

LEDs "OK" and "I_{oL}" status versus output current
 Conditions: $V_{i,min} - V_{i,max}$, $T_C \leq T_{C,max}$, $V_{inh} \leq 0.8 V$

LED "i" versus case temperature
 Conditions: $V_{i,min} - V_{i,max}$, $I_o \leq I_{o,nom}$, $V_{inh} \leq 0.8 V$

LED "i" versus V_{i,inh}
 Conditions: $V_{i,min} - V_{i,max}$, $I_o \leq I_{o,nom}$, $T_C \leq T_{C,max}$

Fig. 12
LED indicators

Electromagnetic Compatibility (EMC)

A suppressor diode or a metal oxide VDR (depending upon converter model) together with an input fuse and an input filter form an effective protection against high input transient voltages, which typically occur in most installations, but especially in battery-driven mobile applications. The M Series has been successfully tested to the following specifications:

Electromagnetic Immunity

Table 9: Immunity type tests

| Phenomenon | Standard | Level | Coupling mode ¹ | Value applied | Waveform | Source imped. | Test procedure | In oper. | Perf. crit. ² |
|--|---------------------|---------------------|----------------------------|----------------------|---|-----------------|---|----------|--------------------------|
| Supply related surge | RIA 12 ³ | A ⁴ | +i/-i | $3.5 \cdot V_{Batt}$ | 2/20/2 ms | 0.2 Ω | 1 positive surge | yes | A |
| | | B | | $1.5 \cdot V_{Batt}$ | 0.1/1/0.1 s | | | | |
| Direct transients | | C | +i/-i, -i/c | 960 V _p | 10/100 μs | 5 Ω | 5 pos. & 5 neg. impulses | yes | A |
| | | D ³ | | 1800 V _p | 5/50 μs | | | | |
| | | E | | 3600 V _p | 0.5/5 μs | | | | |
| | | F | | 4800 V _p | 0.1/1 μs | | | | |
| | | G | | 8400 V _p | 0.05/0.1 μs | | | | |
| Indirect couples transients | | H | -o/c, +o/-o, -o/-i | 1800 V _p | 5/50 μs | 100 Ω | | | |
| | | J | | 3600 V _p | 0.5/5 μs | | | | |
| | | K | | 4800 V _p | 0.1/1 μs | | | | |
| | L | 8400 V _p | | 0.05/0.1 μs | | | | | |
| Electrostatic discharge (to case) | IEC/EN 61000-4-2 | 4 ⁵ | contact discharge | $\pm 8000 V_p$ | 1/50 ns | 330 Ω 150 pF | | | |
| | | | air discharge | $\pm 15000 V_p$ | | | | | |
| Electromagnetic field | IEC/EN 61000-4-3 | x ⁶ | antenna | 20 V/m | AM 80% / 1 kHz | N/A | 80 – 1000 MHz | yes | A ¹¹ |
| Electromagnetic field, pulse modulated | ENV 50204 | 4 ⁷ | | 10 V/m | 50% duty cycle, 200 Hz repetition frequency | | 900 ±5 MHz | yes | A |
| Electrical fast transients / burst | IEC/EN 61000-4-4 | 3 ⁸ | capacitive, o/c | $\pm 2000 V_p$ | bursts of 5/50 ns; 2.5 / 5 kHz over 15 ms; burst period: 300 ms | 50 Ω | 60 s positive 60 s negative transients per coupling mode | yes | A ¹¹ |
| | | 3 ⁸ | direct, i/c, +i/-i | $\pm 2000 V_p$ | | | | | A ¹¹ |
| | | 4 | | $\pm 4000 V_p$ | | | | | B |
| Surges | IEC/EN 61000-4-5 | 3 ⁹ | i/c | 2000 V _p | 1.2 / 50 μs | 12 Ω | 5 pos. & 5 neg. surges per coupling mode | yes | A |
| | | | +i/-i | 1000 V _p | | 2 Ω | | | |
| Conducted disturbances | IEC/EN 61000-4-6 | 3 ¹⁰ | i, o, signal wires | 10 VAC (140 dBμV) | AM 80% / 1 kHz | 150 Ω | 0.15 – 80 MHz | yes | A |
| Power frequency magnetic field | IEC/EN 61000-4-8 | 3 ¹¹ | - | 300 A/m | | | 60 s in all 3 axes | yes | A |

¹ i = input, o = output, c = case

² A = normal operation, no deviation from specs.; B = normal operation, temporary loss of function or deviation from specs possible

³ RIA 12 covers or exceeds IEC 60571-1 and EN 50155:1995. Surge D corresponds to EN 50155:2001, waveform A; surge G corresponds to EN 50155:2001, waveform B.

⁴ Only met with EM (110 V battery) and extended input range models (customer-specific) of BM (24 V battery) and CM (48 V battery). Standard DK models (72 V battery) are not damaged, but overvoltage lockout will occur during the surge.

⁵ Exceeds EN 50121-3-2:2015 table 6.3 and EN 50121-4:2006 table 1.4.

⁶ Corresponds to EN 50121-3-2:2015 table 6.1 and exceeds EN 50121-4:2006 table 1.1. Valid for version V104 or higher.

⁷ Compliance with digital mobile phones.

⁸ Corresponds to EN 50121-3-2:2015 table 5.2 and EN 50121-4:2006 table 2.2.

⁹ Covers or exceeds EN 50121-3-2:2015 table 4.3 and EN 50121-4:2006 table 2.3.

¹⁰ Corresponds to EN 50121-3-2:2015 table 5.1 and EN 50121-4:2006 table 3.1 (radio frequency common mode).

¹¹ Perf. criterion B for triple-output models.

¹² Corresponds to EN 50121-4:2006 table 1.3 for AC systems

Electromagnetic Emissions

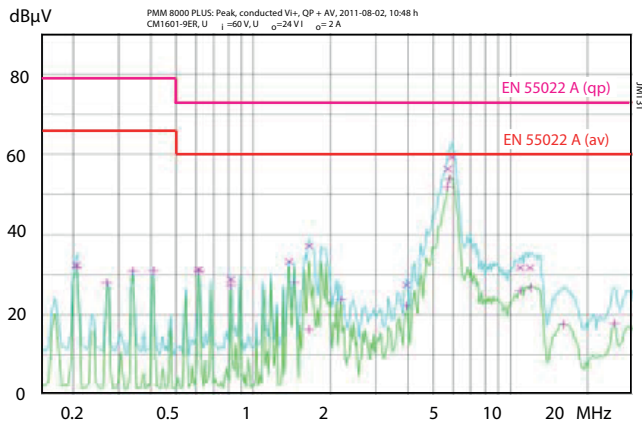


Fig. 13a
Typ. conducted disturbances at the input (quasi-peak and average) of CM1601-9ER according to IEC/EN 55011/22, measured at $V_i = 60$ VDC and $I_{o\ nom}$.

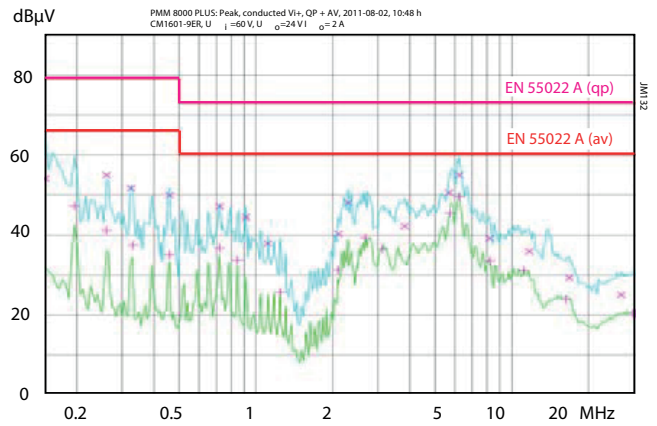


Fig. 13b
Typ. conducted disturbances at the input (quasi-peak and average) of LM1601-9R according to IEC/EN 55011/22, measured at $V_i = 230$ VAC and $I_{o\ nom}$.

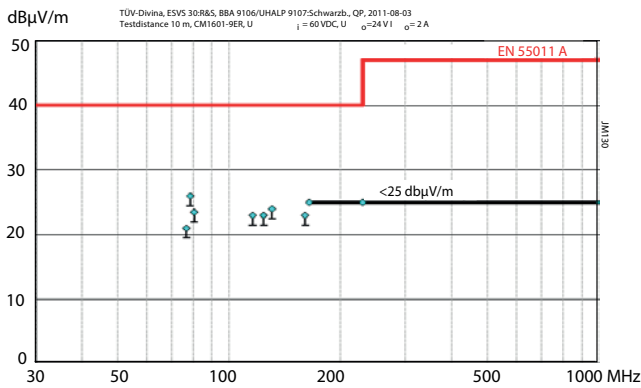


Fig. 14a
Typical radiated emissions of CM1601-9ER according to IEC/EN 55011/22, normalized to a distance of 10 m, measured at $V_i = 60$ VDC and $I_{o\ nom}$.

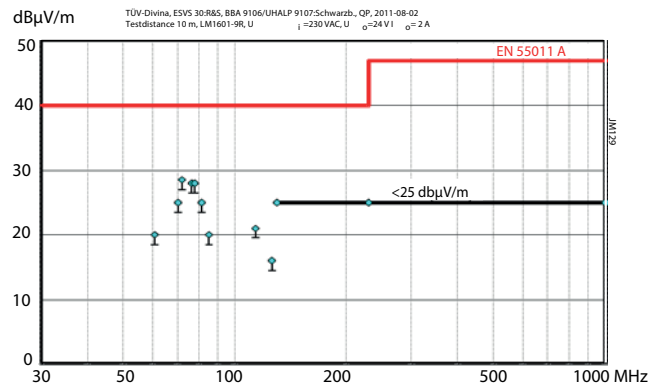


Fig. 14b
Typical radiated emissions of LM1601-9R according to IEC/EN 55011/22, normalized to a distance of 10 m, measured at $V_i = 230$ VAC and $I_{o\ nom}$.

Immunity to Environmental Conditions

Table 10: Mechanical and climatic stress

| Test method | | Standard | Test Conditions | | Status |
|-------------|--|--|--------------------------------|---|-------------------------|
| Db | Damp heat test, cyclic | EN 50155:2007, clause 12.2.5 IEC/EN 60068-2-30 | Temperature: | 55 °C and 25 °C | Converter not operating |
| | | | Cycles (respiration effect): | 2 | |
| | | | Duration: | 2x 24 h | |
| Bd | Dry heat test, steady state | EN 50155:2007, clause 12.2.4 IEC/EN 60068-2-2 | Temperature: | 70 °C | Converter operating |
| | | | Duration: | 6 h | |
| Ad | Cooling test, steady state | EN 50155:2007, clause 12.2.3 IEC/EN 60068-2-1 | Temperature, duration: | - 40 °C, 2 h | Converter not operating |
| | | | Performance test: | +25 °C | |
| Kb | Salt mist, cyclic sodium chloride (NaCl) solution | IEC/EN 60068-2-52 | Concentration: | 5% (30 °C) | Converter not operating |
| | | | Duration: | 2 h per cycle | |
| | | | Storage: | 40 °C, 93% rel. humidity | |
| | | | Storage duration: | 22 h per cycle, 3 cycles | |
| Fc | Vibration (sinusoidal) | IEC/EN 60068-2-6 MIL-STD-810D section 514.3 | Acceleration amplitude: | 0.35 mm (10 – 60 Hz) 5 g _n = 49 m/s ² (60 - 2000 Hz) | Converter operating |
| | | | Frequency (1 Oct/min): | 10 – 2000 Hz | |
| | | | Test duration: | 7.5 h (2.5 h in each axis) | |
| Fda | Random vibration wide band Reproducibility high | IEC 60068-2-35 DIN 40046 part 23 | Acceleration spectral density: | 0.05 g _n ² /Hz | Converter operating |
| | | | Frequency band: | 20 – 500 Hz | |
| | | | Acceleration magnitude: | 4.9 g _{n,rms} | |
| | | | Test duration: | 3 h (1 h in each axis) | |
| Eb | Bump (half-sinusoidal) | IEC/EN 60068-2-29 MIL-STD-810D section 516.3 | Acceleration amplitude: | 40 g _n = 392 m/s ² | Converter operating |
| | | | Bump duration: | 6 ms | |
| | | | Number of bumps: | 6000 (1000 in each direction) | |
| Ea | Shock (half-sinusoidal) | IEC/EN 60068-2-27 MIL-STD-810D section 516.3 | Acceleration amplitude: | 100 g _n = 981 m/s ² | Converter operating |
| | | | Bump duration: | 6 ms | |
| | | | Number of bumps: | 18 (3 in each direction) | |
| - | Shock | EN 50155:2007 clause 12.2.11, EN 61373 sect. 10, class B, body mounted ¹ | Acceleration amplitude: | 5.1 g _n | Converter operating |
| | | | Bump duration: | 30 ms | |
| | | | Number of bumps: | 18 (3 in each direction) | |
| - | Simulated long life testing at increased random vibration levels | EN 50155:2007 clause 12.2.11, EN 61373 sect. 8 and 9, class B, body mounted ¹ | Acceleration spectral density: | 0.02 g _n ² /Hz | Converter operating |
| | | | Frequency band: | 5 – 150 Hz | |
| | | | Acceleration magnitude: | 0.8 g _{n,rms} | |
| | | | Test duration: | 15 h (5 h in each axis) | |

¹ Body mounted = chassis of a railway coach

Temperatures

Table 11: Temperature specifications, valid for an air pressure of 800 – 1200 hPa (800 – 1200 mbar)

| Model | | | -7 (option) | | -9 (standard) | | Unit |
|-----------------|---------------------|---------------------|-------------|-----|---------------|-----|------|
| Characteristics | Conditions | | min | max | min | max | |
| T_A | Ambient temperature | Converter operating | - 25 | 71 | - 40 | 71 | ° C |
| T_C | Case temperature | | - 25 | 95 | - 40 | 95 | |
| T_S | Storage temperature | Not operating | - 40 | 85 | - 55 | 85 | |

Reliability

Table 12: MTBF

| Ratings at specified case temperature | Converter model | Ground benign 40 °C | Ground fixed | | Ground mobile 50 °C | Device hours ² | Unit |
|---------------------------------------|-----------------|------------------------|--------------|--------|------------------------|---------------------------|------|
| | | | 40 °C | 70 °C | | | |
| MTBF ¹ | AM – LM1000 | 320 000 | 130 000 | 40 000 | 35 000 | 880 000 | h |
| | AM – LM2000 | 225 000 | 105 000 | 32 000 | 28 000 | 720 000 | |
| | AM – LM3000 | 225 000 | 80 000 | 28 000 | 25 000 | 740 000 | |

¹ Calculated in accordance with MIL-HDBK-217E

² Statistical values, based on an average of 4300 working hours per year in general field use over 3 years

Mechanical Data

Dimensions in mm.

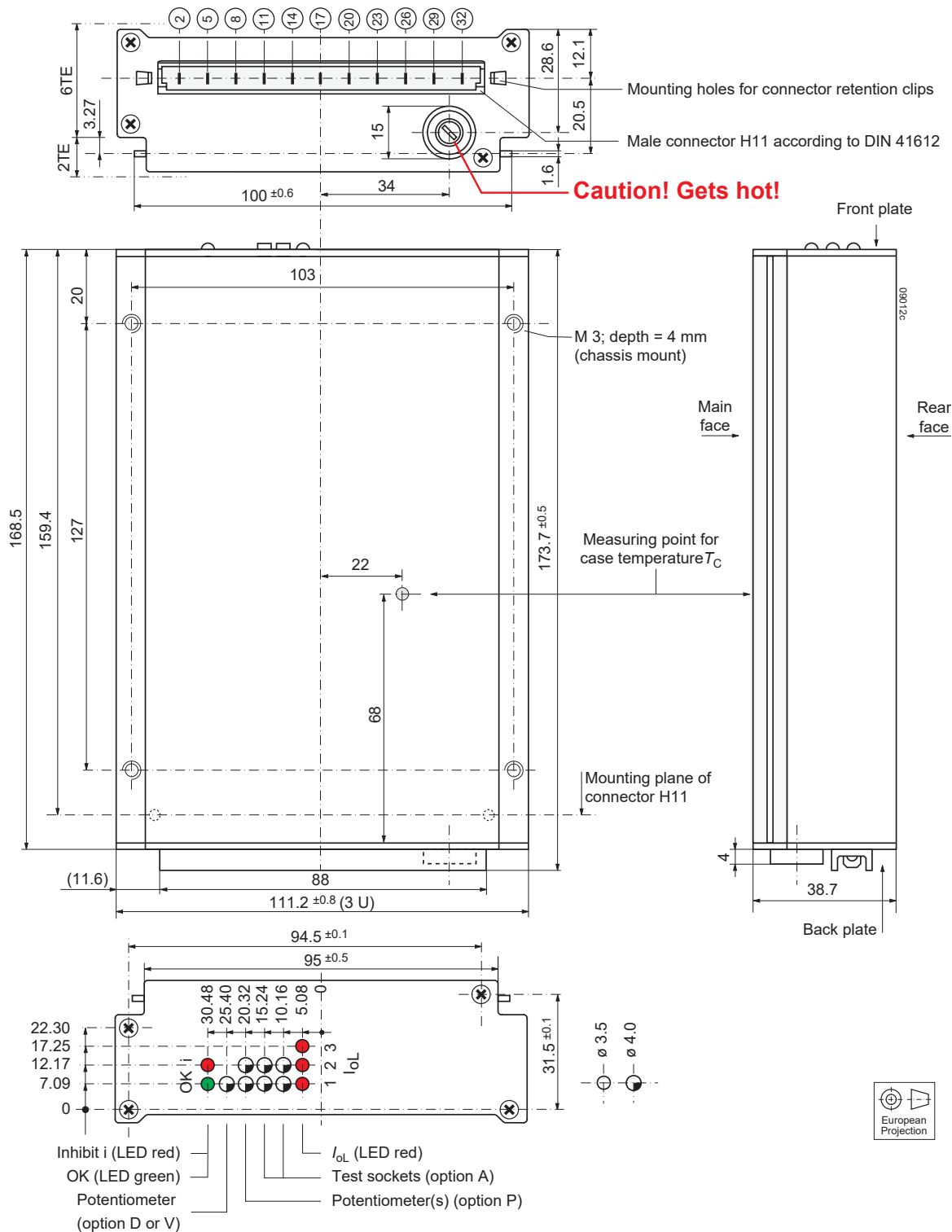


Fig. 15
Case M02, weight 770 g (approx.).
Case aluminum, black finish and self cooling.

Note: Long case, elongated by 60 mm for 220 mm rack depth, is available on request.

Safety and Installation Instructions

Connector Pin Allocation

Pin no. 26 (protective earth) is a leading pin, ensuring that it makes contact with the female connector first.

Table 13: Pin allocation

| Electrical determination | AM - LM1000 | | AM - LM2000 | | AM - LM3000 | |
|----------------------------------|----------------|----------------|----------------|--------|----------------|--------|
| | Pin | Ident | Pin | Ident | Pin | Ident |
| Inhibit | 2 | i | 2 | i | 2 | i |
| Safe data or ACFAIL | 5 ⁵ | D or V | 5 ⁵ | D or V | 5 ⁵ | D or V |
| Output voltage (positive) | 8 | Vo+ | 8 | n.c. | 8 | Vo3+ |
| Output voltage (negative) | 11 | Vo- | 11 | n.c. | 11 | Vo3- |
| Voltage adjust | 14 | R ¹ | | | | |
| Adjust return | 17 | G ¹ | | | | |
| Output voltage (positive) | | | 14 | Vo2+ | 14 | Vo2+ |
| Output voltage (negative) | | | 17 | Vo2- | 17 | Vo2- |
| Output voltage (positive) | 20 | Vo+ | 20 | Vo1+ | 20 | Vo1+ |
| Output voltage (negative) | 23 | Vo- | 23 | Vo1- | 23 | Vo1- |
| Protective earth PE ² | 26 | ⊕ | 26 | ⊕ | 26 | ⊕ |
| DC input voltage ³ | 29 | Vi+ | 29 | Vi+ | 29 | Vi+ |
| DC input voltage | 32 | Vi- | 32 | Vi- | 32 | Vi- |
| AC input voltage ⁴ | 29 | N≈ | 29 | N≈ | 29 | N≈ |
| AC input voltage | 32 | L≈ | 32 | L≈ | 32 | L≈ |

- ¹ Not connected if option P is fitted
- ² Leading pin
- ³ AM, BM, CM, DM, EM, and FM models
- ⁴ LM models
- ⁵ Not connected if option neither option D or V is fitted

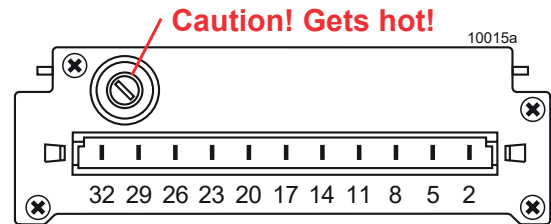


Fig. 16
View of male H11 connector.

Installation Instructions

All M Series converters are components, intended exclusively for inclusion within other equipment by professional installers. Installation must strictly follow the national safety regulations in compliance with the enclosure, mounting, creepage, clearance, casualty, markings and segregation requirements of the end-use application.

Connection to the system shall be made via the female connector H11. Other installation methods may not meet the safety requirements.

The converters are provided with the leading pin 26 (⊕), which is reliably connected with the case. For safety reasons, it is essential to connect pin 26 with the protective earth of the supply system.

An input fuse is connected in the line to pin 32 (Vi- or L≈). Since this fuse is designed to protect the converter in case of an overcurrent and does not necessarily cover all customer needs, an external fuse suitable for the application and in compliance with the local requirements may be necessary in the wiring to one or both input pins (no. 29 and/or no. 32), particularly if the phase or neutral line cannot be assigned to the corresponding terminals (LM models operated with AC).

Important: Whenever the inhibit function is not in use, pin 2 (i) should be connected to pin 23 (Vo-) to enable the output(s).

Caution: Do not open the converters, or warranty will be invalidated.

Make sure that there is sufficient air flow possible for convection cooling. This should be verified by measuring the case temperature T_C , when the converter is installed and operated in the end-use application. The maximum specified case temperature $T_{C\max}$ shall not be exceeded. See also *Thermal Considerations*.

Operation of LM Models at Greater than 63 Hz

In such a case, the converters may exceed the leakage current of 3.5 mA imposed in the safety standards. A warning marking is required in the end-use product.

Protection Degree and Cleaning Liquids

Condition: Female connector fitted to the converter.

IP 40: All models, except those with options P or A, and except those with option D/V with potentiometer.

IP 30: All models fitted with options A or option D/V without potentiometer.

IP 20: All models fitted with option P or with option D/V with potentiometer.

In order to avoid possible damage, any penetration of liquids (e.g., cleaning fluids) has to be avoided.

Railway Applications

The M Series converters have been designed observing the railway standards EN 50155 and EN 50121. All boards are coated with a protection lacquer.

Standards and Approvals

The converters correspond to class I equipment and have been approved according to the standards IEC/EN 60950-1 and UL/CSA 60950-1 2nd Ed.

The converters have been evaluated for:

- Class I equipment
- Building in
- Basic insulation between input and case and double or reinforced insulation between input and output, based on the input voltage of 250 VAC or 400 VDC
- Functional insulation between output(s) and case
- Functional insulation between the outputs
- Pollution degree 2 environment
- Overvoltage category II
- Altitude up to 2000 m

The converters are subject to manufacturing surveillance in accordance with the above mentioned standards and with ISO 9001:2015.

Isolation

The electric strength test is performed in the factory as routine test in accordance with EN 50514 and IEC/EN 60950. The company will not honor any warranty claims resulting from incorrectly executed electric strength field tests.

Table 14: Isolation

| Characteristics | | Input to Case + Output(s) | Output(s) to Case (standard) | Output(s) to Case (option H) | Output to Output | Unit |
|----------------------------------|--|---------------------------|------------------------------|------------------------------|-------------------|------|
| Electric strength test | Factory test >1 s | 2.8 ¹ | 1.4 | 2.8 | 0.3 | kVDC |
| | AC test voltage equivalent to factory test | 2.0 ¹ | 1.0 | 2.0 | 0.2 | kVAC |
| Insulation resistance at 500 VDC | | >300 | >300 | >300 | >100 ² | MΩ |
| Creepage distances | | ≥ 3.2 ³ | --- | --- | --- | mm |

¹ According to IEC/EN 60950, sub-assemblies connecting input to output are pre-tested with 5.6 kVDC or 4 kVAC.

² Tested at 300 VDC

³ Input to outputs: ≥6.4 mm

Safety of Operator-Accessible Output Circuits

If the output circuit of a DC-DC converter is operator-accessible, it shall be an SELV circuit according to the IEC/EN 60950 safety standards.

Since the M Series converters provide double or reinforced insulation between input and output based upon a rated primary input voltage of 250 VAC or 400 VDC, only functional insulation is needed between the AC mains and the input of the converter.

Only voltage adaption and rectification to the specified input voltage range of a DC/DC converter is needed.

Table 15 shows a possible installation configuration, compliance with which causes the output circuit of the DC-DC converter to be an SELV circuit according to IEC/EN 60950 up to a configured output voltage (sum of nominal voltages if in series or +/- configuration) of 48 V. However, it is the sole responsibility of the installer to assure the compliance with the relevant and applicable safety regulations.



Fig. 17
Schematic safety concept

Table 15: Safety concept leading to an SELV output circuit

| Conditions | Front end | | | DC-DC converter | | Result |
|------------------------|---|---|--|-----------------|---|---|
| | Minimum required grade of insulation, to be provided by the AC-DC front end, including mains supplied battery charger | Maximum rated DC output voltage from the front end | Minimum required safety status of the front end output circuit | Equipment | Measures to achieve the specified safety status of the output circuit | |
| Nominal supply voltage | Operational (i.e. there is no need for electrical isolation between the mains supply voltage and the DC-DC converter input voltage) | 400 VDC ¹ (The rated voltage between any input pin and earth can be up to 250 VAC or 400 VDC) | Primary circuit | A-LM | Double or reinforced insulation, based on 250 VAC and 400 VDC (provided by the DC-DC converter) and earthed case ² | Safety status of the DC-DC converter output circuit |

¹ The front end output voltage should match the specified operating input voltage range of the DC-DC converter.

² The earth connection has to be provided by the installer according to the safety standard IEC/EN 60950.

Description of Options

Table 16: Survey of options

| Option | Function of option | Characteristics |
|------------------|---|---|
| - 7 | Former standard operational ambient temperature range | $T_A = -25$ to 71 °C |
| A | Test sockets at front panel for check of output voltage | V_o internally measured at the connector terminals |
| E | Electronic inrush current limitation circuitry | Active inrush current limitation, only for CM, EM, LM models |
| P ¹ | Potentiometer for fine adjustment of output voltage | Adjustment range $\pm 5\%$ of $V_{o, nom}$, excludes R input |
| F | Input fuse built-in | Fuse not externally accessible, only for FM1000 |
| H | Enhanced output to case electric strength test voltage | See table <i>Isolation</i> |
| D ² | Input and/or output undervoltage monitoring circuitry | Safe data signal output (D0 – D9) |
| V ^{2,3} | Input and/or output undervoltage monitoring circuitry | ACFAIL signal according to VME specifications (V0, V2, V3) |
| K | Coding strip at the connector | Ensuring correct population of DIN-racks |
| G | RoHS | RoHS-compatible for all six substances |

¹ Models equipped with option P do not provide the R function; pins 14 and 17 are not connected.

² Option D excludes option V and vice versa.

³ Only available if main output voltage $V_{o1} = 5.1$ V

-7 Former Standard Temperature Range

Option -7 stays for the operational ambient temperature range from -25 to 71 °C, which may be preferred by some customers for reasons of documentation or approvals.

A Test Sockets

Test sockets (pin $\varnothing = 2$ mm, distance $d = 5.08$ mm) are located at the front of the converter. The output voltage is sensed at the connector pins inside of the converter. Outputs 2 and 3 of triple-output models are not sensed.

P Potentiometer

Built-in multi-turn potentiometers provide an output voltage adjustment range of minimum $\pm 5\%$ of $V_{o, nom}$ and are accessible through holes in the front cover. Compensation of voltage drop across connector and wiring becomes easily achievable. For output voltages $V_o > V_{o, nom}$, the minimum input voltage according to *Electrical Input Data* increases proportionally to $V_o/V_{o, nom}$. Triple-output models allow only the adjustment of V_{o1} .

Note: Potentiometers are not recommended for mobile applications.

E Electronic Inrush Current Limitation

Available for CM, EM and LM models.

The standard version of the models CM, DM, EM and LM include a passive inrush current limitation with an NTC resistor. For applications requiring an improved inrush current limitation, an active electronic circuit as shown in fig.18 has been developed. Typical inrush current waveforms of units equipped with this option are shown below.

CM models meet the CEPT/ETSI standards for 48V supply voltage according to ETS 300132-2, if fitted with option E combined with option D6 (input voltage monitoring). Option D6, externally adjustable via potentiometer, is necessary to disable the converter at input voltages below the actual service ranges, avoiding an excessive input current when the input voltage is raised slowly according to ETS 300132-2. Option D6 threshold level $V_{ti} + V_{hi}$ (refer to description of option D) should be adjusted to $36 - 40.5$ V for 48 V nominal supply voltage (for 60 V systems, threshold should be set to $44 - 50$ V). The D output (pin 5) should be connected to the inhibit (pin 2). For applications, where potentiometers are not allowed, refer to option D9.

Table 18: Inrush current characteristics with option E

| Characteristics | | CM at $V_i = 110$ VDC | | EM, LM at $V_i = 110$ VDC | | EM, LM at $V_i = 372$ VDC | | Unit |
|-----------------|-------------------------|--------------------------|-----|------------------------------|-----|------------------------------|-----|------|
| | | typ | max | typ | max | typ | max | |
| $I_{inr p}$ | Peak inrush current | 6.5 | 8 | 2.2 | 4 | 7.3 | 10 | A |
| t_{inr} | Inrush current duration | 22 | 30 | 10 | 20 | 20 | 40 | ms |

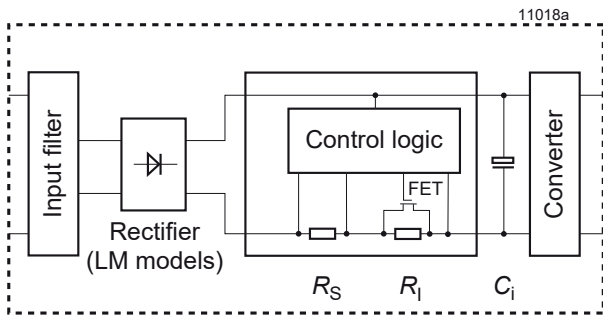


Fig. 18
Option E block diagram

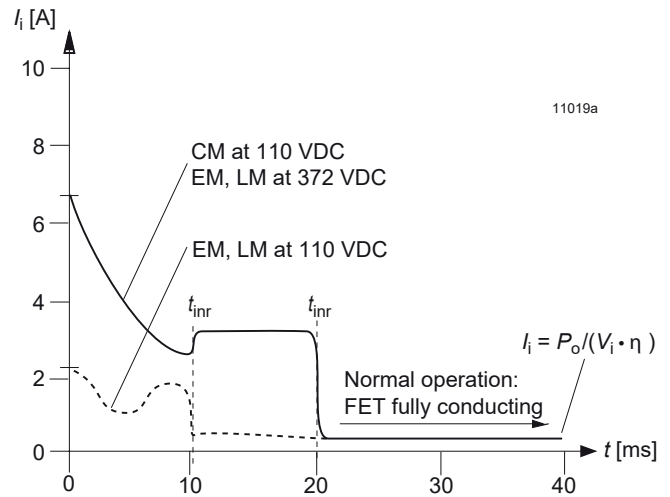


Fig. 19
Typical inrush current waveforms of CM, EM, and LM converters with option E

Precautions:

In order to avoid overload of the series resistor R_s , the on/off switching cycle should be limited to 12 s, if switched on/off continuously. There should not be more than 10 start-up cycles within 20 s at a case temperature of 25 °C.

If CM models are driven by input voltages below 35 VDC or LM models below 100 VAC, the maximum case temperature should be derated by 10 °C, or the total output power should be derated by 20%. EM and LM models driven by DC input voltages do not need to be derated within the full specified input voltage range.

F Fuse Not Accessible

Standard M converters have a fuseholder containing a 5 × 20 mm fuse, which is externally accessible and located in the back plate near to the connector. Some applications require an inaccessible fuse. Option F provides a fuse mounted directly onto the main PCB inside the case (only FM1000).

The full self-protecting functions of the converter do normally not lead to a broken fuse, except as a result of inverse polarity at the input of an AM, BM, CM, DM, or FM models, or if a power component inside fails. In such cases the defective converter must be returned to the Company for repair.

H Enhanced Electric Strength Test

Electric strength test output to case; see table *Isolation*.

D Undervoltage Monitor

The input and/or output undervoltage monitor operates independently of the built-in input undervoltage lock-out circuit. A logic “low” (JFET output) or “high” signal (NPN output) is generated at pin 5, when one of the monitored voltages drops below the preselected threshold level V_l . The return for this signal is Vo1– (pin 23). The D output recovers, when the monitored voltage(s) exceed(s) $V_l + V_h$. The threshold level V_l is either adjustable by a potentiometer accessible through a hole in the front cover, or adjusted in the factory to a fixed value specified by the customer.

Option D exists in various versions D0 – D9, as shown in the Table 19.

JFET output (D0 – D4):

Connector pin D is internally connected via the drain-source path of a JFET (self-conducting type) to the negative potential of output 1. $V_D \leq 0.4$ V (logic low) corresponds to a monitored voltage level (V_i and/or V_{o1}) < V_l . The current I_D through the JFET should not exceed 2.5 mA. The JFET is protected by a 0.5 W Zener diode of 8.2 V against external overvoltages.

NPN output (D5 – D9):

Connector pin D is internally connected via the collector-emitter path of a NPN transistor to the negative potential of output 1. $V_D \leq 0.4$ V (logic low) corresponds to a monitored voltage level (V_i and/or V_{o1}) > $V_l + V_h$. The current I_D through the open collector should not exceed 20 mA. The NPN output is not protected against external overvoltages. V_D should not exceed 40 V.

Table 19: Undervoltage monitor functions

| Output type | | Monitoring | | Minimum adjustment range of threshold level V_t | | Typ. hysteresis V_h [% of V_t] for $V_{t\min} - V_{t\max}$ | |
|-------------|-----|------------|----------|---|--------------------------------|---|--------------------|
| JFET | NPN | V_i | V_{o1} | V_{ti} | V_{to} | V_{hi} | V_{ho} |
| D1 | D5 | no | yes | --- | $3.5\text{ V} - 48\text{ V}^1$ | --- | $2.3 - 1\text{ V}$ |
| D2 | D6 | yes | no | $V_{i\min} - V_{i\max}^1$ | --- | $3.0 - 0.5\text{ V}$ | --- |
| D3 | D7 | yes | yes | $V_{i\min} - V_{i\max}^1$ | $0.95 - 0.98 V_{o1}^2$ | $3.0 - 0.5\text{ V}$ | "0" |
| D4 | D8 | no | yes | --- | $0.95 - 0.98 V_{o1}^2$ | --- | "0" |
| D0 | D9 | no | yes | --- | $3.5\text{ V} - 48\text{ V}^3$ | --- | $1.8 - 1\text{ V}$ |
| | | yes | no | $V_{i\min} - V_{i\max}^{3,4}$ | --- | $2.2 - 0.4\text{ V}$ | --- |
| | | yes | yes | $V_{i\min} - V_{i\max}^{3,4}$ | $0.95 - 0.98 V_{o1}^2$ | $2.2 - 0.4\text{ V}$ | "0" |

¹ Threshold level adjustable by potentiometer (not recommended for mobile applications)
² Fixed value between 95% and 98% of V_{o1} (tracking)
³ Fixed value, resistor-adjusted according to customer's specification $\pm 2\%$ at $25\text{ }^\circ\text{C}$; individual type number is determined by the company.
⁴ Adjusted at $I_{o\text{nom}}$

Table 20: JFET output (D0 – D4)

| V_i, V_{o1} status | D output, V_D |
|--------------------------------|--|
| V_i or $V_{o1} < V_t$ | low, L, $V_D \leq 0.4\text{ V}$ at $I_D = 2.5\text{ mA}$ |
| V_i and $V_{o1} > V_t + V_h$ | high, H, $I_D \leq 25\text{ }\mu\text{A}$ at $V_D = 5.25\text{ V}$ |

Table 21: NPN output (D5 – DD)

| V_i, V_{o1} status | D output, V_D |
|--------------------------------|--|
| V_i or $V_{o1} < V_t$ | high, H, $I_D \leq 25\text{ }\mu\text{A}$ at $V_D = 40\text{ V}$ |
| V_i and $V_{o1} > V_t + V_h$ | low, L, $V_D \leq 0.4\text{ V}$ at $I_D = 20\text{ mA}$ |

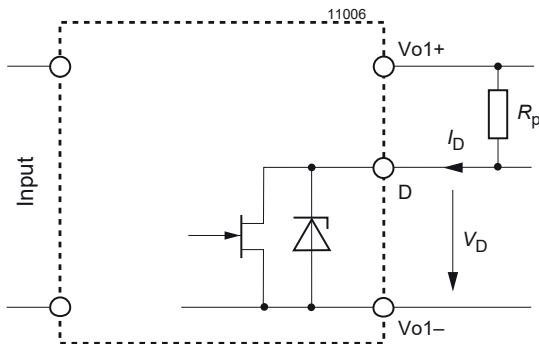


Fig. 20 Options D0 – D4, JFET output

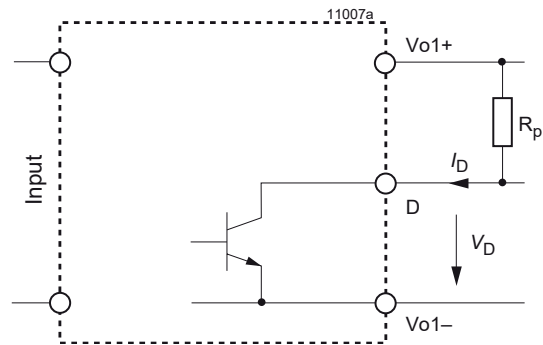


Fig. 21 Options D5 – D9, NPN output

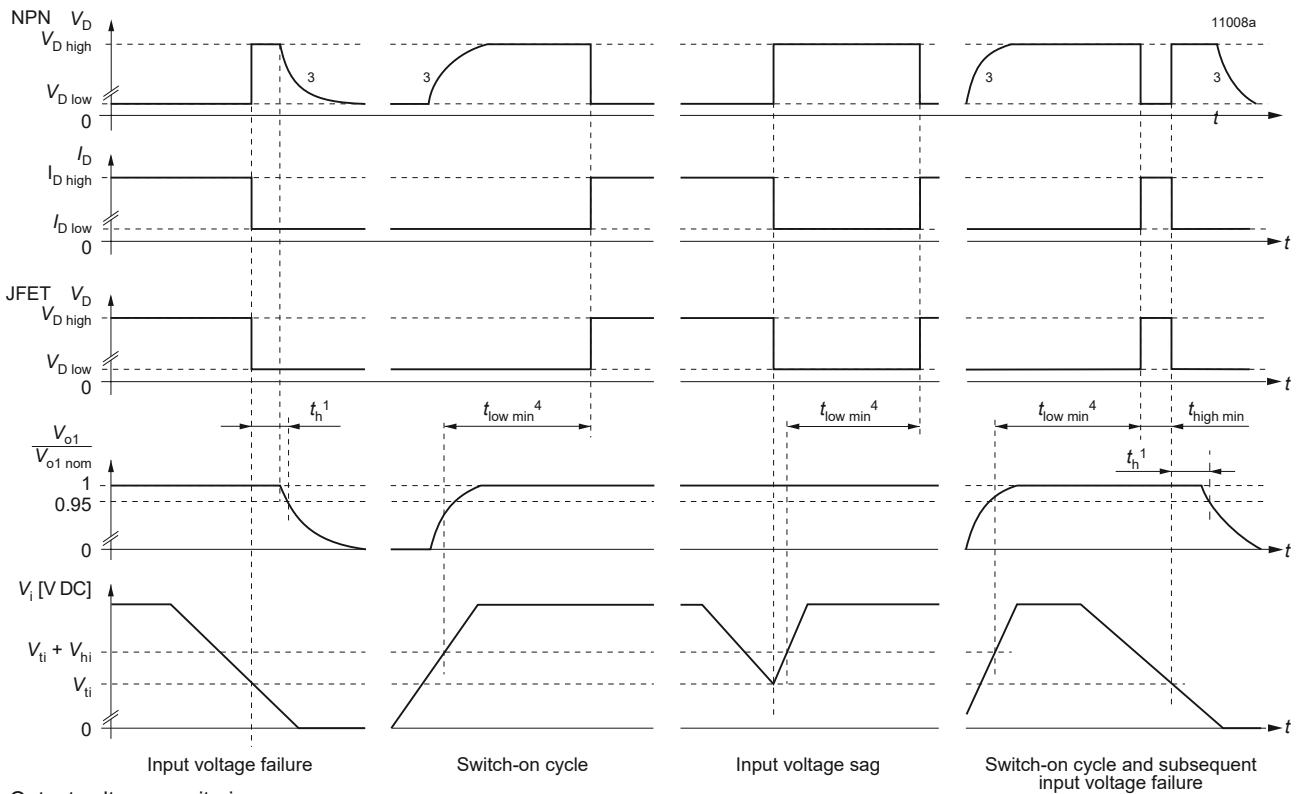
Threshold tolerances and hysteresis:

If V_i is monitored, the internal input voltage after the input filter and rectifier (EM and LM types) is measured. Consequently, this voltage differs from the voltage at the connector pins by the voltage drop ΔV_{ti} across input filter and rectifier. The threshold level of the D0 and D9 options is adjusted in the factory at nominal output current $I_{o\text{nom}}$ and $T_A = 25\text{ }^\circ\text{C}$. The value of ΔV_{ti} depends upon input voltage range (AM, BM, etc.), threshold level V_t , temperature, and input current.

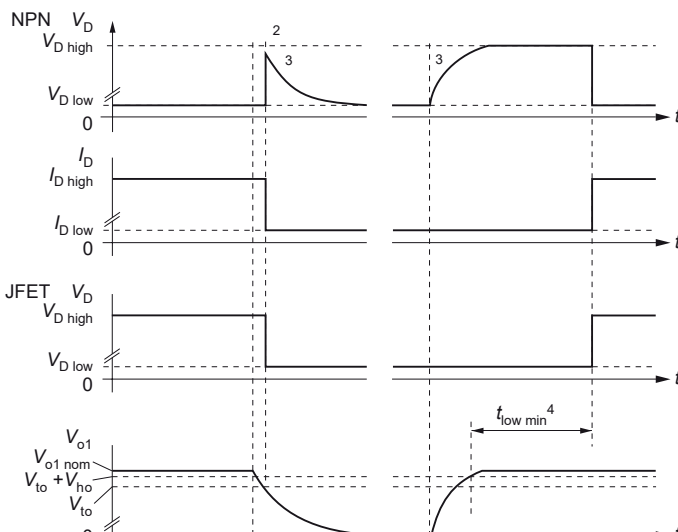


Fig. 22 Definition of V_{ti} , ΔV_{ti} , and V_{hi} (JFET output)

Input voltage monitoring



Output voltage monitoring



- ¹ See *Electrical Output Data* for hold-up time.
- ² With output voltage monitoring the hold-up time $t_h = 0$
- ³ The D signal remains high, if the D output is connected to an external source.

Fig. 23 Relationship between V_i , V_o , V_D , $V_o/V_{o\ nom}$ versus time

V ACFAIL signal (VME)

Available for converters with $V_{o1} = 5.1$ V. This option defines an undervoltage monitoring circuit for the input or the input and main output voltage equivalent to option D and generates the ACFAIL signal (V signal), which conforms to the VME standard. The low state level of the ACFAIL signal is specified at a sink current of $I_V = 48$ mA to $V_V \leq 0.6$ V (open-collector output). The pull-up resistor feeding the open-collector output should be placed on the VME backplane.

After the ACFAIL signal has gone low, the VME standard requires a hold-up time t_h of at least 4 ms before the 5.1 V output drops to 4.875 V, when the 5.1 V output is fully loaded. This hold-up time t_h is provided by the internal input capacitance. Consequently the working input voltage and the threshold level V_{ti} should be adequately above the minimum input voltage V_{imin} of the converter, so that enough energy is remaining in the input capacitance. If the input voltage is below the required level, an external hold-up capacitor (C_{iext}) should be added.

Formula for threshold level for desired value of t_h :

$$V_{ti} = \sqrt{\frac{2 \cdot P_o \cdot (t_h + 0.3 \text{ ms}) \cdot 100}{C_{imin} \cdot \eta}} + V_{imin}^2$$

Formula for additional external input capacitor

$$C_{iext} = \frac{2 \cdot P_o \cdot (t_h + 0.3 \text{ ms}) \cdot 100}{\eta \cdot (V_{ti}^2 - V_{imin}^2)} - C_{imin}$$

where as:

C_{imin} = internal input capacitance [mF],
according to table below

C_{iext} = external input capacitance [mF]

P_o = output power [W]

η = efficiency [%]

t_h = hold-up time [ms]

V_{imin} = minimum input voltage [V]¹

V_{ti} = threshold level [V]

Notes: The threshold level V_{ti} of option V2 and V3 is adjusted in the factory to a value according to the table below. A decoupling diode should be connected in series with the input of AM, BM, CM, DM, and FM converters to avoid the input capacitance discharging through other loads connected to the same source voltage. If LM models are powered by AC, an external input capacitor cannot be applied unless an additional rectifier is provided.

Table 20: Available internal input capacitance and factory potentiometer setting of U_{ti} with resulting hold-up time

| Types | AM | BM | CM | DM | EM | FM | LM | Unit |
|------------|------|------|------|------|------|------|------|------|
| C_{imin} | 2.6 | 0.67 | 0.37 | 0.14 | 0.14 | 0.37 | 0.14 | mF |
| V_{ti} | 9.5 | 19.5 | 39 | 61 | 104 | 39 | 120 | VDC |
| t_h | 0.34 | 0.69 | 1.92 | 1.73 | 6.69 | 2.92 | 8.18 | ms |

Option V operates independently of the built-in input undervoltage lockout circuit. A logic "low" signal is generated at pin 5 as soon as one of the monitored voltages drops below the preselected threshold level V_t . The return for this signal is Vo1– (pin 23). The V output recovers, when the monitored voltage exceeds $V_t + V_h$. The threshold level V_t is either adjustable by a potentiometer, accessible through a hole in the front cover, or adjusted in the factory to a determined customer-specific value. Versions V0, V2 and V3 are available as shown below.

Table 21: Undervoltage monitor functions

| V output (VME compatible) | Monitoring | | Minimum adjustment range of threshold level V_t | | Typical hysteresis U_h [% of V_t] for $V_{tmin} - V_{tmax}$ | |
|------------------------------|------------|----------|--|------------------------|---|----------|
| | V_i | V_{o1} | V_{ti} | V_{to} | V_{hi} | V_{ho} |
| V2 | yes | no | $V_{imin} - V_{imax}^1$ | --- | 3.0 – 0.5 V | --- |
| V3 | yes | yes | $V_{imin} - V_{imax}^1$ | $0.95 - 0.98 V_{o1}^2$ | 3.0 – 0.5 V | "0" |
| V0 | yes | no | $V_{imin} - V_{imax}^{3,4}$ | --- | 2.2 – 0.4 V | --- |
| | yes | yes | $V_{imin} - V_{imax}^{3,4}$ | $0.95 - 0.98 V_{o1}^2$ | 2.2 – 0.4 V | "0" |

¹ Threshold level adjustable by potentiometer (not recommended for mobile applications).

² Fixed value between 95% and 98% of V_{o1} (tracking), output undervoltage monitoring is not a requirement of VME standard.

³ Adjusted at $I_{o,nom}$.

⁴ Fixed value, resistor-adjusted ($\pm 2\%$) acc. to customer's specifications; individual type designation is determined by the company.

V output (V0, V2, V3):

Connector pin V is internally connected to the open collector of a NPN transistor. The emitter is connected to the negative potential of output 1. V_V 0.6 V (logic low) corresponds to a monitored voltage level (V_i and/or V_{o1}) $< U_t$. The current I_V through the open collector should not exceed 50 mA. The NPN output is not protected against external overvoltages. V_V should not exceed 80 V.

| V_i, V_{o1} status | V output, V_V |
|--------------------------------|---|
| V_i or $V_{o1} < V_t$ | low, L, $V_V \leq 0.6$ V at $I_V = 50$ mA |
| V_i and $V_{o1} > V_t + V_h$ | high, H, $I_V \leq 25$ μ A at $V_V = 5.1$ V |

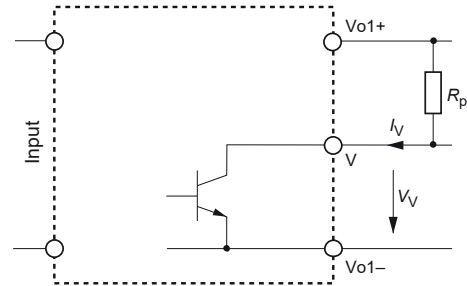


Fig. 24
Output configuration of options V0, V2, V3

Threshold tolerances and hysteresis

V_i is monitored after the input filter and rectifier (EM and LM models). Consequently, this voltage differs from the voltage at the connector pins by the voltage drop ΔV_{ti} across input filter and rectifier. The threshold level of option V0 is factory-adjusted at $I_{o, nom}$ and $T_A = 25$ °C. ΔV_{ti} depends upon the input voltage range (AM, BM, ...), threshold level V_{ti} , temperature, and input current.

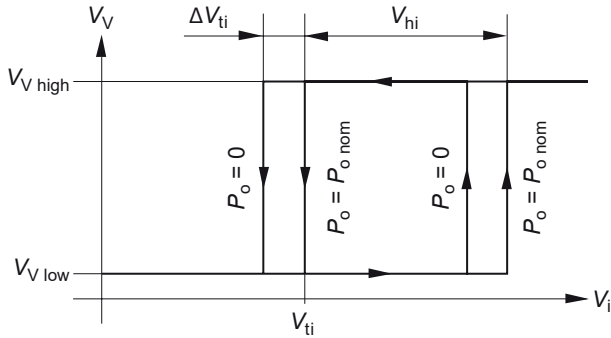


Fig. 25
Definition of V_{ti} , ΔV_{ti} and V_{hi}

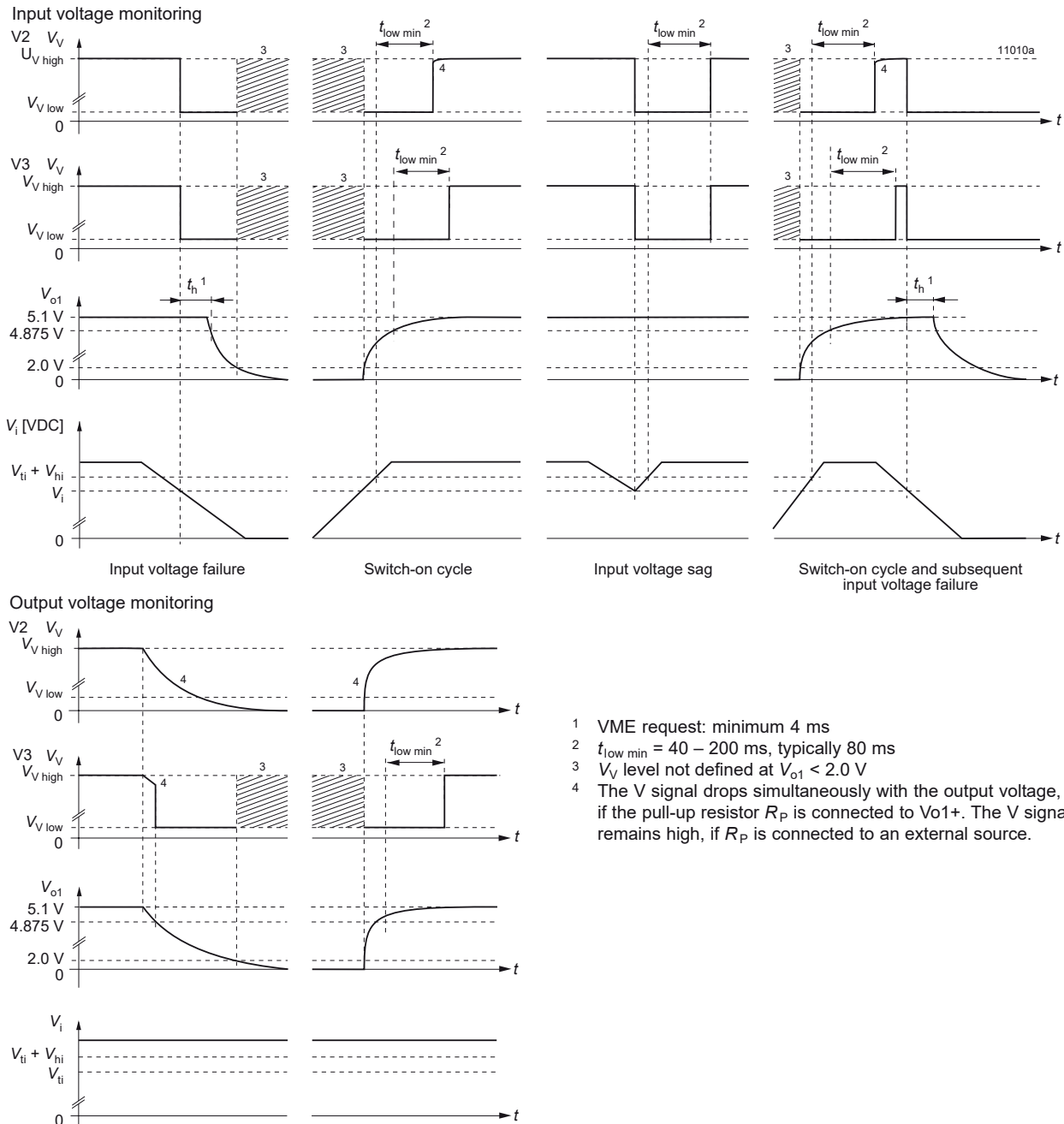


Fig. 26 Relationship between V_P , V_{o1} , V_V , I_V , and $V_{o1}/V_{o\ nom}$ versus time.

K Coding Strip

A plastic part across the connector ensures correct population of the DIN-rack.

G RoHS

RoHS-compatible for all six substances. For the dimensions of the cooling plates, see *Mechanical Data*. Option B2 is for customer-specific models with elongated case (for 220 mm DIN-rack depth).

Accessories

A great variety of electrical and mechanical accessories are available including:

- Various mating H11 connectors including solder, fast-on, or press-fit terminals
- Pair of connector retention clips HZZ01209-G
- Code key system: 5 coding wedges HZZ00202-G
- Various front panels for 19" rack mounting
- Flexible H11 PCB board HZZ01208-G for connecting with a mother board
- Universal mounting bracket UMB-LHMQ (HZZ00610-G) for chassis or DIN-rail mounting in upright position.
- DIN-rail mounting brackets DMB-MHQ (HZZ00619-G)
- Mounting plate M (HZZ01208) for chassis or a wall mounting, where only frontal access is given
- Battery sensor [S-KSMH...] for using the converter as battery charger (different cell characteristics).

For additional accessory product information, see the accessory data sheets listed with each product series or individual model at our web site.



Fig. 27
Different front panels



Fig. 28
Flexible H11 PCB (HZZ01208-G)



Fig. 29
A pair of connector retention clips (HZZ01209-G)



Fig. 30
Mounting plate M (HZZ01210), connector with fast-on terminals (HZZ00101-G), secured with retention clips (HZZ01209-G)



Fig. 31
Universal mounting bracket for DIN-rail mounting (HZZ00610-G)

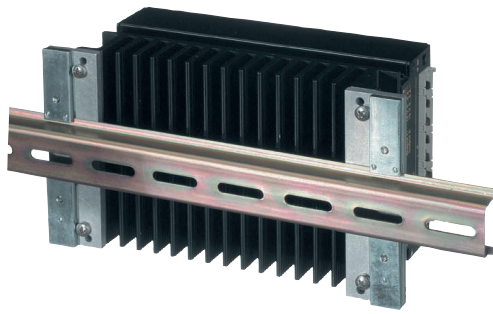


Fig. 32
DIN-rail mounting brackets DMB-MHQ (HZZ00619-G)

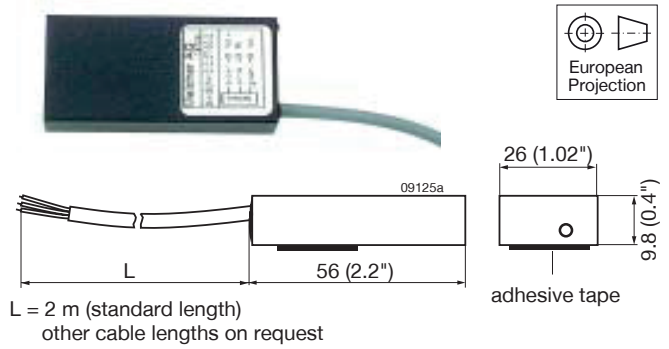


Fig.33
Battery temperature sensor S-KSMH

NUCLEAR AND MEDICAL APPLICATIONS - These products are not designed or intended for use as critical components in life support systems, equipment used in hazardous environments, or nuclear control systems.

TECHNICAL REVISIONS - The appearance of products, including safety agency certifications pictured on labels, may change depending on the date manufactured. Specifications are subject to change without notice.

Компания «Океан Электроники» предлагает заключение долгосрочных отношений при поставках импортных электронных компонентов на взаимовыгодных условиях!

Наши преимущества:

- Поставка оригинальных импортных электронных компонентов напрямую с производств Америки, Европы и Азии, а так же с крупнейших складов мира;
- Широкая линейка поставок активных и пассивных импортных электронных компонентов (более 30 млн. наименований);
- Поставка сложных, дефицитных, либо снятых с производства позиций;
- Оперативные сроки поставки под заказ (от 5 рабочих дней);
- Экспресс доставка в любую точку России;
- Помощь Конструкторского Отдела и консультации квалифицированных инженеров;
- Техническая поддержка проекта, помощь в подборе аналогов, поставка прототипов;
- Поставка электронных компонентов под контролем ВП;
- Система менеджмента качества сертифицирована по Международному стандарту ISO 9001;
- При необходимости вся продукция военного и аэрокосмического назначения проходит испытания и сертификацию в лаборатории (по согласованию с заказчиком);
- Поставка специализированных компонентов военного и аэрокосмического уровня качества (Xilinx, Altera, Analog Devices, Intersil, Interpoint, Microsemi, Actel, Aeroflex, Peregrine, VPT, Syfer, Eurofarad, Texas Instruments, MS Kennedy, Miteq, Cobham, E2V, MA-COM, Hittite, Mini-Circuits, General Dynamics и др.);

Компания «Океан Электроники» является официальным дистрибьютором и эксклюзивным представителем в России одного из крупнейших производителей разъемов военного и аэрокосмического назначения «JONHON», а так же официальным дистрибьютором и эксклюзивным представителем в России производителя высокотехнологичных и надежных решений для передачи СВЧ сигналов «FORSTAR».



JONHON

«JONHON» (основан в 1970 г.)

Разъемы специального, военного и аэрокосмического назначения:

(Применяются в военной, авиационной, аэрокосмической, морской, железнодорожной, горно- и нефтедобывающей отраслях промышленности)

«FORSTAR» (основан в 1998 г.)

ВЧ соединители, коаксиальные кабели,
кабельные сборки и микроволновые компоненты:

(Применяются в телекоммуникациях гражданского и специального назначения, в средствах связи, РЛС, а так же военной, авиационной и аэрокосмической отраслях промышленности).



Телефон: 8 (812) 309-75-97 (многоканальный)

Факс: 8 (812) 320-03-32

Электронная почта: ocean@oceanchips.ru

Web: <http://oceanchips.ru/>

Адрес: 198099, г. Санкт-Петербург, ул. Калинина, д. 2, корп. 4, лит. А