

MICROPOWER, ULTRA-SENSITIVE OMNIPOLAR HALL-EFFECT SENSOR SWITCH

Description

The AH1802 is a high-sensitivity, micropower, omnipolar Hall Effect switch integrated circuit (IC) designed for portable and battery-powered equipment, such as cellular phones, PDAs, and portable PCs. Based on two sensitive Hall Effect plates and a chopper-stabilized architecture, the AH1802 provides a reliable solution over the whole operating range. To support portable and battery-powered equipment, the design has been optimized to operate over the supply range of 2.5V to 5.5V and consumes only 24 μ W with a supply of 3V.

The single open-drain output can be switched on with either a north or south pole of sufficient strength. When the magnetic flux density (B) perpendicular to the part marking surface is larger than operate point (Bop), the output is switched on (pulled low). The output is turned off when B becomes lower than the release point (Brp). The output remains off when there is no magnetic field.

Pin Assignments

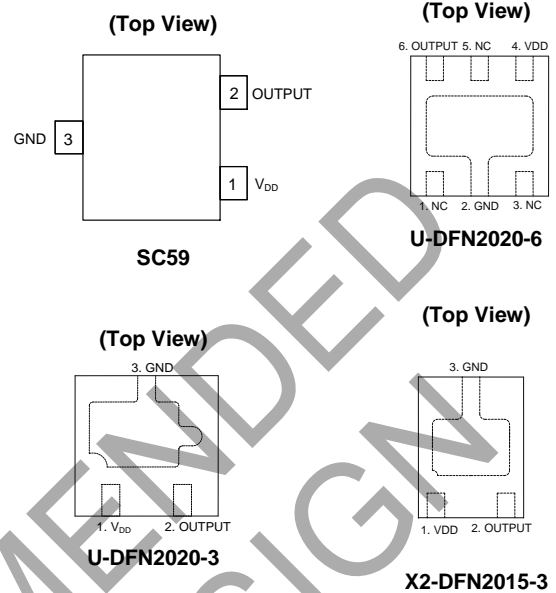

Features

- Omnipolar (North or South Pole) Operation
- 2.5V to 5.5V Operating Range
- High Sensitivity
- Single Open-Drain Output
- Micropower Operation
- Chopper-Stabilized Design Provides
 - Superior Temperature Stability
 - Minimal Switch Point Drift
 - Enhanced Immunity to Stress
- Good RF Noise Immunity
- -40°C to +85°C Operating Temperature
- ESD > 5kV for U-DFN2020-6, U-DFN2020-3 and X2-DFN2015-3
- ESD > 6kV for SC59
- Low Profile SC59, U-DFN2020-6, U-DFN2020-3 and X2-DFN2015-3 packages
- **Totally Lead-Free & Fully RoHS Compliant (Notes 1 & 2)**
- **Halogen and Antimony Free. "Green" Device (Note 3)**

Applications

- Open and Close Detect for Flip/Slide Cellular Phones
- Smart Cover or Dock Detect for Cellular Phones and Tablets
- Cover or Display Switch in Portable PCs (such as Ultrabook™)
- Display Switch for Portable PCs
- On/Off switch for PDAs and Digital Cameras
- Contactless Switch in Consumer Products

Notes:

1. No purposely added lead. Fully EU Directive 2002/95/EC (RoHS), 2011/65/EU (RoHS 2) & 2015/863/EU (RoHS 3) compliant.
2. See <https://www.diodes.com/quality/lead-free/> for more information about Diodes Incorporated's definitions of Halogen- and Antimony-free, "Green" and Lead-free.
3. Halogen- and Antimony-free "Green" products are defined as those which contain <900ppm bromine, <900ppm chlorine (<1500ppm total Br + Cl) and <1000ppm antimony compounds.

Typical Applications Circuit

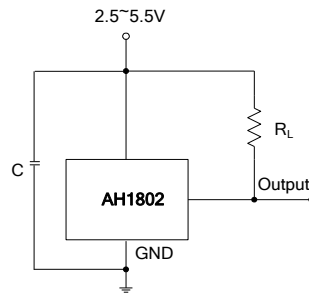

Pin Descriptions

Package: SC59

Pin Number	Pin Name	Function
1	V _{DD}	Power Supply Input
2	OUTPUT	Output Pin
3	GND	Ground Pin

Package: U-DFN2020-3 and X2-DFN2015-3

Pin Number	Pin Name	Function
1	V _{DD}	Power Supply Input
2	OUTPUT	Output Pin
3	GND	Ground Pin

Package: U-DFN2020-6 and X2-DFN2015-3

Pin Number	Pin Name	Function
1	NC	No Connection (Note 4)
2	GND	Ground Pin
3	NC	No Connection (Note 4)
4	V _{DD}	Power Supply Input
5	NC	No Connection (Note 4)
6	OUTPUT	Output Pin

Note: 4. NC is *No Connection*—recommendation is to connect the NC pin to ground externally.

Functional Block Diagram

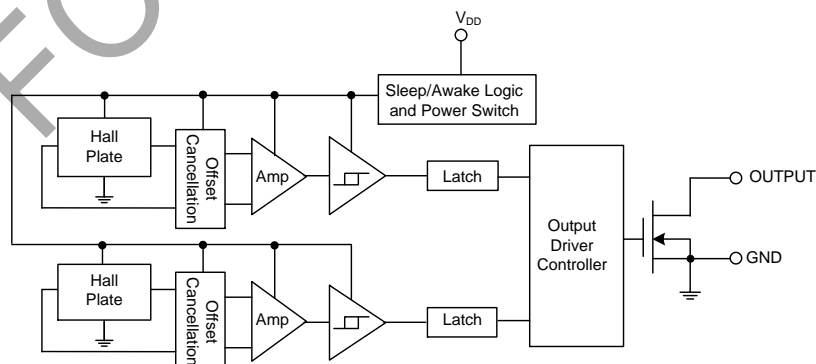

Absolute Maximum Ratings (Note 6) (@ $T_A = +25^\circ\text{C}$, unless otherwise specified.)

Symbol	Parameter	Values	Unit
V_{DD}	Supply Voltage (Note 7)	7	V
B	Magnetic Flux Density	Unlimited	
T_s	Storage Temperature Range	-65 to +150	$^\circ\text{C}$
P_D	Package Power Dissipation	230	mW
T_J	Maximum Junction Temperature	150	$^\circ\text{C}$

- Notes:
- Stresses greater than the 'Absolute Maximum Ratings' specified above may cause permanent damage to the device. These are stress ratings only; functional operation of the device at these or any other conditions exceeding those indicated in this specification is not implied. Device reliability may be affected by exposure to absolute maximum rating conditions for extended periods of time.
 - The absolute maximum V_{DD} of 7V is a transient stress rating and is not meant as a functional operating condition. It is not recommended to operate the device at the absolute maximum rated conditions for any period of time.

Recommended Operating Conditions (@ $T_A = +25^\circ\text{C}$, unless otherwise specified.)

Symbol	Parameter	Conditions	Rating	Unit
V_{DD}	Supply Voltage	Operating	2.5 to 5.5	V
T_A	Operating Temperature Range	Operating	-40 to +85	$^\circ\text{C}$

Electrical Characteristics (@ $V_{DD} = 3\text{V}$, $T_A = +25^\circ\text{C}$, unless otherwise specified.)

Symbol	Characteristic	Conditions	Min	Typ	Max	Unit
V_{OUT}	Output On Voltage (V_{OL})	$I_{OUT} = 1\text{mA}$	—	0.1	0.3	V
I_{OFF}	Output Leakage Current	$V_{OUT} = 5.5\text{V}$, $B < Brp$	—	<0.1	1	μA
$I_{DD}(\text{awake})$	Supply Current	During 'Awake' Period, $T_A = +25^\circ\text{C}$, $V_{DD} = 3\text{V}$	—	3	6	mA
		During 'Awake' Period, $T_A = -40$ to $+85^\circ\text{C}$, $V_{DD} = 2.5$ to 5.5V	—	3	10	mA
$I_{DD}(\text{sleep})$		During 'Sleep' Period, $T_A = +25^\circ\text{C}$, $V_{DD} = 3\text{V}$	—	5	10	μA
		During 'Sleep' Period, $T_A = -40$ to $+85^\circ\text{C}$, $V_{DD} = 2.5$ – 5.5V	—	5	18	μA
$I_{DD}(\text{avg})$		Average Supply Current , $T_A = +25^\circ\text{C}$, $V_{DD} = 3\text{V}$	—	8	16	μA
		Average Supply Current , $T_A = -40$ to $+85^\circ\text{C}$, $V_{DD} = 2.5$ to 5.5V	—	8	23	μA
F_C	Chopping Frequency	For Design Information Only	—	300	—	kHz
T_{awake}	Awake Time	(Note 8)	—	75	150	μs
T_{period}	Period	(Note 8)	—	75	150	ms
D.C.	Duty Cycle	—	—	0.1	—	%

- Note: 8. When power is initially turned on, V_{DD} must be within its correct operating range (2.5V to 5.5V) to guaranteed the output sampling. The output state is valid after the second operating cycle (typical 150ms).

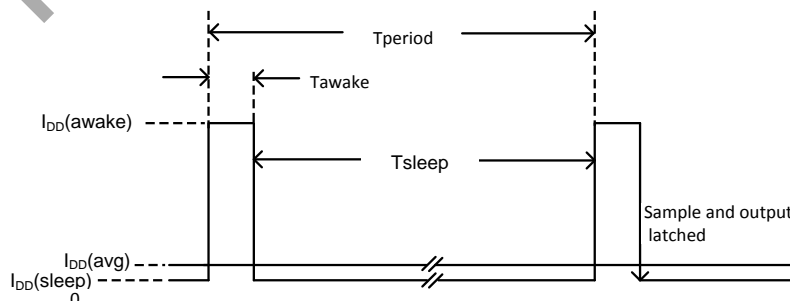

Magnetic Characteristics (Notes 9 & 10) (@ $V_{DD} = 3V$, $T_A = +25^\circ C$, unless otherwise specified.)

(1mT=10 Gauss)

Symbol	Characteristic	Min	Typ	Max	Unit
Bops(South Pole to Part Marking Side)	Operate Point	20	28	40	Gauss
Bopn(North Pole to Part Marking Side)		-40	-28	-20	
Brps(South Pole to Part Marking Side)	Release Point	10	20	—	
Brpn(North Pole to Part Marking Side)		—	-20	-10	
$B_{hy}(B_{opx} - B_{rp})$	Hysteresis	5	8	—	

Notes: 9. Typical data is at $T_A = +25^\circ C$, $V_{DD} = 3V$, and for design information only.
10. The magnetic characteristics may vary with supply voltage, operating temperature, and after soldering.

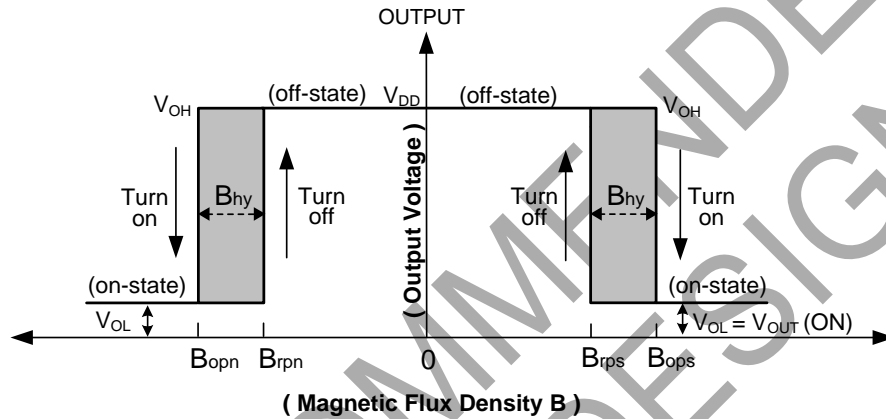

Performance Characteristics

T_A (°C)	25	50	60	70	80	85	90	100	110	120	130	140	150
P_D (mW)	230	184	166	147	129	120	110	92	74	55	37	18	0

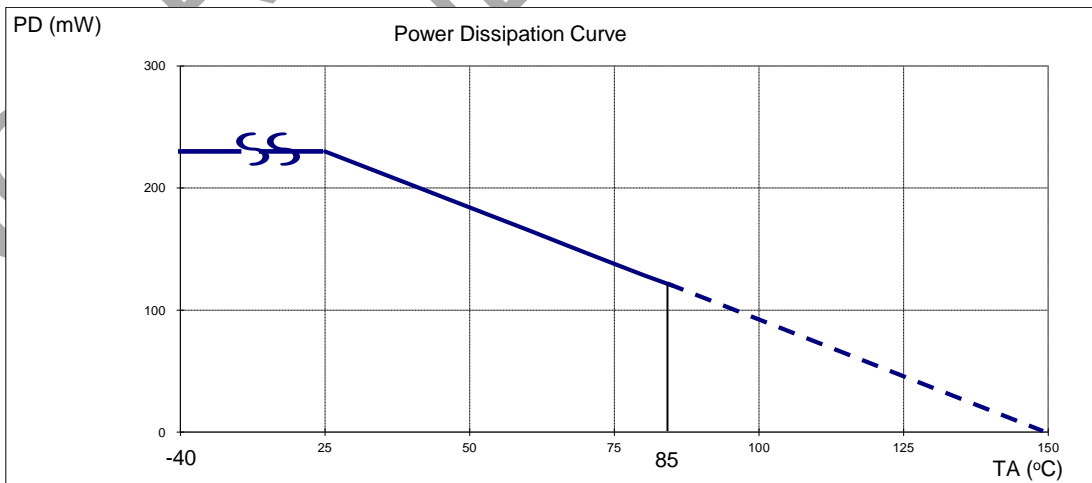

Ordering Information

AH 1802 - XXX G - 7 - 01

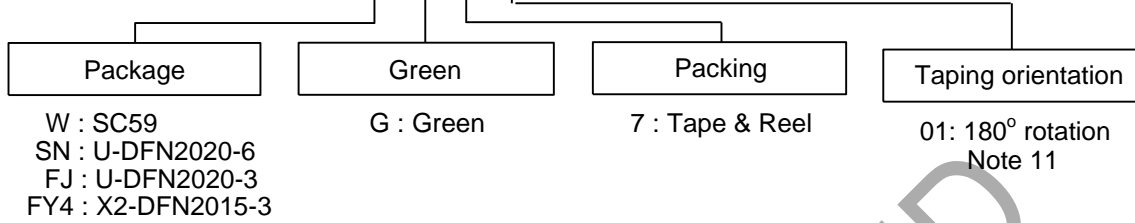

Part Number	Status (Note 12)	Package Code	Packaging	7" Tape and Reel	
				Quantity	Part Number Suffix
AH1802-WG-7	NRND	W	SC59	3000/Tape & Reel	-7
AH1802-SNG-7	NRND	SN	U-DFN2020-6	3000/Tape & Reel	-7
AH1802-FJG-7	NRND	FJ	U-DFN2020-3	3000/Tape & Reel	-7
AH1802-FJG-7-01 (Note 8)	NRND	FJ	U-DFN2020-3	3000/Tape & Reel	-7
AH1802-FY4G-7	NRND	FY4	X2-DFN2015-3	3000/Tape & Reel	-7

Note: 11. AH1802-FJG-7-01 DFN2020-3 package taping orientation is rotated by 180° compared to standard part AH1802-FJG-7. See package orientation diagrams on pages 9 and 10.
12. NRND = Not Recommended for New Design

Marking Information

(1) Package Type: SC59

(Top View)

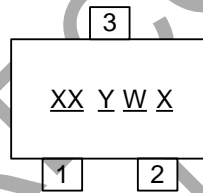

XX : Identification code
Y : Year 0~9
W : Week : A~Z : 1~26 week;
a~z : 27~52 week; z represents 52 and 53 week
X : A~Z : Green

Part Number	Package	Identification Code
AH1802	SC59	KC

(2) Package Type: U-DFN2020-6

(Top View)

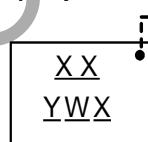

Pin 1 indicator
XX : Identification Code
Y : Year : 0~9
W : Week : A~Z : 1~26 week;
a~z : 27~52 week; z represents 52 and 53 week
X : A~Z : Green

Part Number	Package	Identification Code
AH1802	U-DFN2020-6	KC

Marking Information (continued)

(3) Package Type: U-DFN2020-3

(Top View)

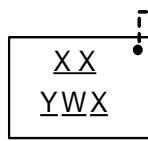

Pin 1 indicator
XX : Identification Code
Y : Year : 0~9
W : Week : A~Z : 1~26 week;
 a~z : 27~52 week; z represents
 52 and 53 week
X : A~Z : Green

Part Number	Package	Identification Code
AH1802	U-DFN2020-3	KE

(4) Package Type: X2-DFN2015-3

(Top View)

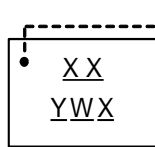

Pin 1 indicator
XX : Identification Code
Y : Year : 0~9
W : Week : A~Z : 1~26 week;
 a~z : 27~52 week; z represents
 52 and 53 week
X : A~Z : Green

Part Number	Package	Identification Code
AH1802	X2-DFN2015-3	KF

NOT RECOMMENDED FOR NEW DESIGN

Package Outline Dimensions (All dimensions in mm.)

Please see <http://www.diodes.com/package-outlines.html> for the latest version.

(1) Package Type: SC59

SC59

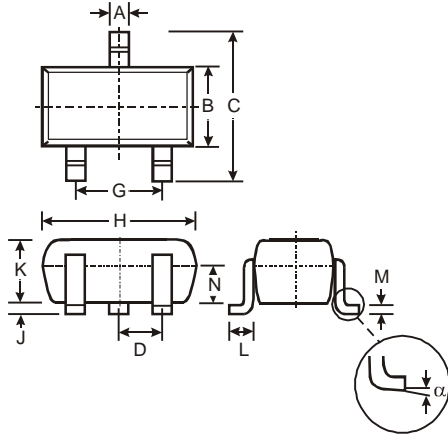

SC59			
Dim	Min	Max	Typ
A	0.35	0.50	0.38
B	1.50	1.70	1.60
C	2.70	3.00	2.80
D	-	-	0.95
G	-	-	1.90
H	2.90	3.10	3.00
J	0.013	0.10	0.05
K	1.00	1.30	1.10
L	0.35	0.55	0.40
M	0.10	0.20	0.15
N	0.70	0.80	0.75
	$\square .0^\circ$	8°	-
All Dimensions in mm			

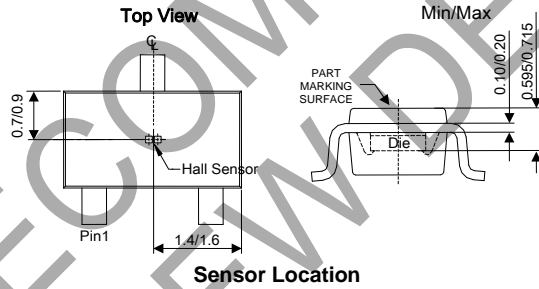

NOT RECOMMENDED FOR NEW DESIGN

Package Outline Dimensions (continued) (All dimensions in mm.)

Please see <http://www.diodes.com/package-outlines.html> for the latest version.

(2) Package Type: U-DFN2020-6

U-DFN2020-6

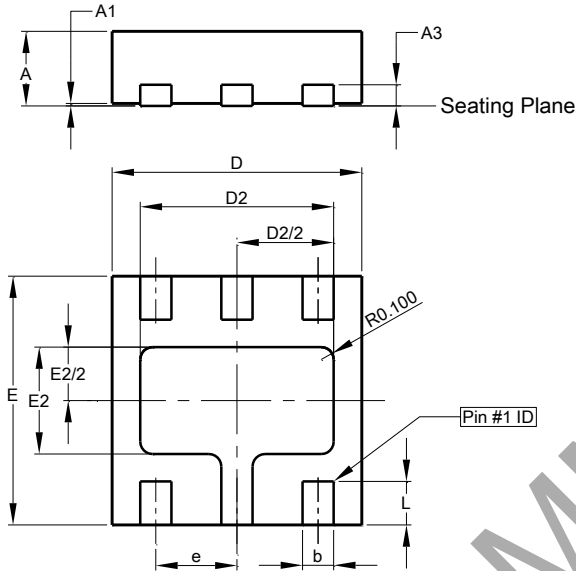

U-DFN2020-6			
Dim	Min	Max	Typ
A	0.57	0.63	0.60
A1	0	0.05	0.03
A3	-	-	0.15
b	0.20	0.30	0.25
D	1.95	2.075	2.00
D2	1.45	1.65	1.55
e	-	-	0.65
E	1.95	2.075	2.00
E2	0.76	0.96	0.86
L	0.30	0.40	0.35
All Dimensions in mm			

(3) Package type: U-DFN2020-3

U-DFN2020-3

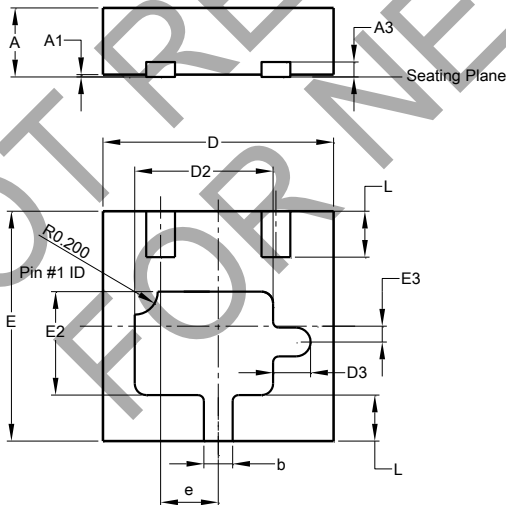

U-DFN2020-3			
Dim	Min	Max	Typ
A	0.57	0.63	0.60
A1	0	0.05	0.02
A3	-	-	0.152
b	0.20	0.30	0.25
D	1.950	2.075	2.00
D2	1.10	1.30	1.20
D3	0.325 REF		
e	-	-	0.50
E	1.950	2.075	2.00
E2	0.80	1.00	0.90
E3	0.138 REF		
L	0.35	0.45	0.40
All Dimensions in mm			

Package Outline Dimensions (cont.) (All dimensions in mm.)

Please see <http://www.diodes.com/package-outlines.html> for the latest version.

(4) Package type: X2-DFN2015-3

X2-DFN2015-3

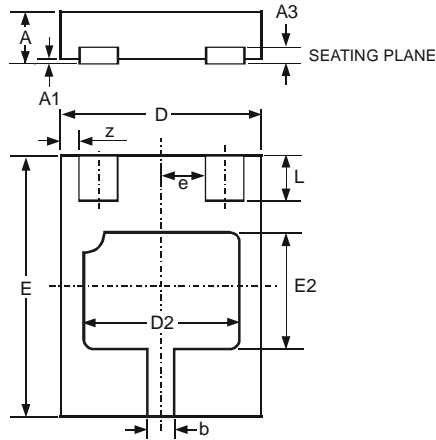

X2-DFN2015-3			
Dim	Min	Max	Typ
A	-	0.40	-
A1	0	0.05	0.02
A3	-	-	0.13
b	0.20	0.30	0.25
D	1.45	1.575	1.5
D2	1.00	1.20	1.10
e	-	-	0.50
E	1.95	2.075	2.00
E2	0.70	0.90	0.80
L	0.25	0.35	0.30
z	-	-	0.125
All Dimensions in mm			

Suggested Pad Layout

Please see <http://www.diodes.com/package-outlines.html> for the latest version.

(1) Package Type: SC59

SC59

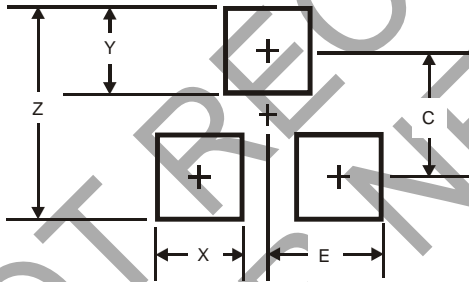

Dimensions	SC59
Z	3.4
X	0.8
Y	1.0
C	2.4
E	1.35

(2) Package Type: U-DFN2020-6

U-DFN2020-6

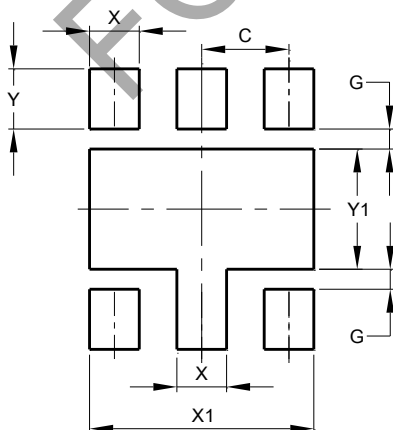

Dimensions	Value (in mm)
C	0.65
G	0.15
X	0.37
X1	1.67
Y	0.45
Y1	0.90

Suggested Pad Layout (continued)

Please see <http://www.diodes.com/package-outlines.html> for the latest version.

(3) Package Type: U-DFN2020-3

U-DFN2020-3

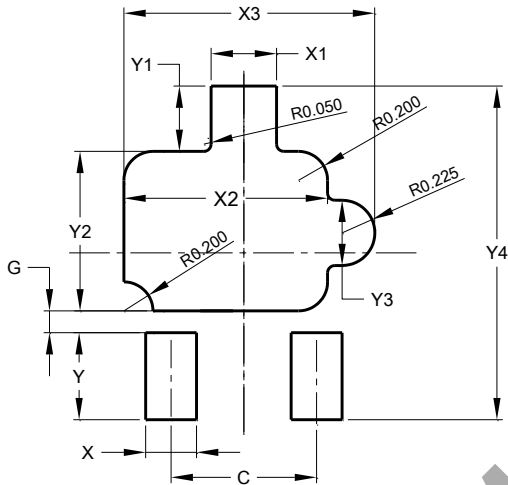

Dimensions	Value (in mm)
C	1.000
G	0.150
X	0.350
X1	0.450
X2	1.400
X3	1.724
Y	0.600
Y1	0.450
Y2	1.100
Y3	0.450
Y4	2.300

(4) Package Type: X2-DFN2015-3

X2-DFN2015-3

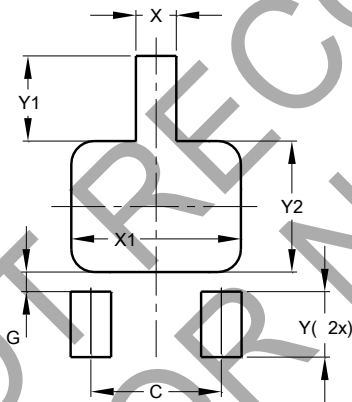

X2-DFN2015-3	
Dimensions	Value (in mm)
C	1.000
G	0.150
X	0.310
X1	1.300
Y	0.500
Y1	0.650
Y2	1.000

IMPORTANT NOTICE

DIODES INCORPORATED MAKES NO WARRANTY OF ANY KIND, EXPRESS OR IMPLIED, WITH REGARDS TO THIS DOCUMENT, INCLUDING, BUT NOT LIMITED TO, THE IMPLIED WARRANTIES OF MERCHANTABILITY AND FITNESS FOR A PARTICULAR PURPOSE (AND THEIR EQUIVALENTS UNDER THE LAWS OF ANY JURISDICTION).

Diodes Incorporated and its subsidiaries reserve the right to make modifications, enhancements, improvements, corrections or other changes without further notice to this document and any product described herein. Diodes Incorporated does not assume any liability arising out of the application or use of this document or any product described herein; neither does Diodes Incorporated convey any license under its patent or trademark rights, nor the rights of others. Any Customer or user of this document or products described herein in such applications shall assume all risks of such use and will agree to hold Diodes Incorporated and all the companies whose products are represented on Diodes Incorporated website, harmless against all damages.

Diodes Incorporated does not warrant or accept any liability whatsoever in respect of any products purchased through unauthorized sales channel. Should Customers purchase or use Diodes Incorporated products for any unintended or unauthorized application, Customers shall indemnify and hold Diodes Incorporated and its representatives harmless against all claims, damages, expenses, and attorney fees arising out of, directly or indirectly, any claim of personal injury or death associated with such unintended or unauthorized application.

Products described herein may be covered by one or more United States, international or foreign patents pending. Product names and markings noted herein may also be covered by one or more United States, international or foreign trademarks.

This document is written in English but may be translated into multiple languages for reference. Only the English version of this document is the final and determinative format released by Diodes Incorporated.

LIFE SUPPORT

Diodes Incorporated products are specifically not authorized for use as critical components in life support devices or systems without the express written approval of the Chief Executive Officer of Diodes Incorporated. As used herein:

A. Life support devices or systems are devices or systems which:

1. are intended to implant into the body, or
2. support or sustain life and whose failure to perform when properly used in accordance with instructions for use provided in the labeling can be reasonably expected to result in significant injury to the user.

B. A critical component is any component in a life support device or system whose failure to perform can be reasonably expected to cause the failure of the life support device or to affect its safety or effectiveness.

Customers represent that they have all necessary expertise in the safety and regulatory ramifications of their life support devices or systems, and acknowledge and agree that they are solely responsible for all legal, regulatory and safety-related requirements concerning their products and any use of Diodes Incorporated products in such safety-critical, life support devices or systems, notwithstanding any devices- or systems-related information or support that may be provided by Diodes Incorporated. Further, Customers must fully indemnify Diodes Incorporated and its representatives against any damages arising out of the use of Diodes Incorporated products in such safety-critical, life support devices or systems.

Copyright © 2018, Diodes Incorporated

www.diodes.com

Компания «Океан Электроники» предлагает заключение долгосрочных отношений при поставках импортных электронных компонентов на взаимовыгодных условиях!

Наши преимущества:

- Поставка оригинальных импортных электронных компонентов напрямую с производств Америки, Европы и Азии, а так же с крупнейших складов мира;
- Широкая линейка поставок активных и пассивных импортных электронных компонентов (более 30 млн. наименований);
- Поставка сложных, дефицитных, либо снятых с производства позиций;
- Оперативные сроки поставки под заказ (от 5 рабочих дней);
- Экспресс доставка в любую точку России;
- Помощь Конструкторского Отдела и консультации квалифицированных инженеров;
- Техническая поддержка проекта, помощь в подборе аналогов, поставка прототипов;
- Поставка электронных компонентов под контролем ВП;
- Система менеджмента качества сертифицирована по Международному стандарту ISO 9001;
- При необходимости вся продукция военного и аэрокосмического назначения проходит испытания и сертификацию в лаборатории (по согласованию с заказчиком);
- Поставка специализированных компонентов военного и аэрокосмического уровня качества (Xilinx, Altera, Analog Devices, Intersil, Interpoint, Microsemi, Actel, Aeroflex, Peregrine, VPT, Syfer, Eurofarad, Texas Instruments, MS Kennedy, Miteq, Cobham, E2V, MA-COM, Hittite, Mini-Circuits, General Dynamics и др.);

Компания «Океан Электроники» является официальным дистрибьютором и эксклюзивным представителем в России одного из крупнейших производителей разъемов военного и аэрокосмического назначения «JONHON», а так же официальным дистрибьютором и эксклюзивным представителем в России производителя высокотехнологичных и надежных решений для передачи СВЧ сигналов «FORSTAR».



JONHON

«JONHON» (основан в 1970 г.)

Разъемы специального, военного и аэрокосмического назначения:

(Применяются в военной, авиационной, аэрокосмической, морской, железнодорожной, горно- и нефтедобывающей отраслях промышленности)

«FORSTAR» (основан в 1998 г.)

ВЧ соединители, коаксиальные кабели, кабельные сборки и микроволновые компоненты:

(Применяются в телекоммуникациях гражданского и специального назначения, в средствах связи, РЛС, а так же военной, авиационной и аэрокосмической отраслях промышленности).



Телефон: 8 (812) 309-75-97 (многоканальный)

Факс: 8 (812) 320-03-32

Электронная почта: ocean@oceanchips.ru

Web: <http://oceanchips.ru/>

Адрес: 198099, г. Санкт-Петербург, ул. Калинина, д. 2, корп. 4, лит. А