

## Advanced Single or Dual Cell Lithium-Ion/ Lithium-Polymer Charge Management Controllers

### Features

- Linear Charge Management Controllers
- High-Accuracy Preset Voltage Regulation:
  - $\pm 0.5\%$  (max)
- Four Preset Voltage Regulation Options:
  - 4.1V - MCP73841-4.1, MCP73843-4.1
  - 4.2V - MCP73841-4.2, MCP73843-4.2
  - 8.2V - MCP73842-8.2, MCP73844-8.2
  - 8.4V - MCP73842-8.4, MCP73844-8.4
- Programmable Charge Current
- Programmable Safety Charge Timers
- Preconditioning of Deeply Depleted Cells
- Automatic End-of-Charge Control
- Optional Continuous Cell Temperature Monitoring (MCP73841 and MCP73842)
- Charge Status Output for Direct LED Drive
- Automatic Power-Down when Input Power Removed
- Temperature Range:  $-40^{\circ}\text{C}$  to  $85^{\circ}\text{C}$
- Packaging: MSOP-10 - MCP73841, MCP73842  
MSOP-8 - MCP73843, MCP73844

### Applications

- Lithium-Ion/Lithium-Polymer Battery Chargers
- Personal Data Assistants
- Cellular Telephones
- Hand-Held Instruments
- Cradle Chargers
- Digital Cameras
- MP3 Players

### Typical Application Circuit

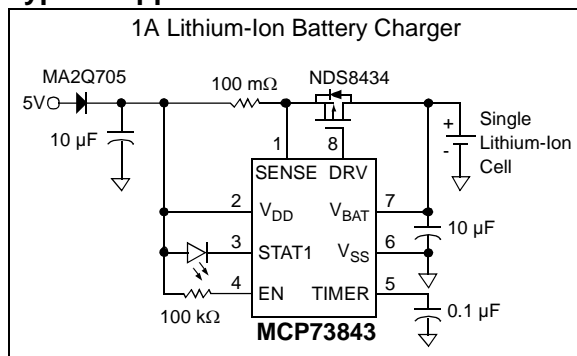

### Description

The MCP7384X family of devices are highly advanced linear charge management controllers for use in space-limited, cost-sensitive applications. The MCP73841 and MCP73842 combine high accuracy, constant-voltage, constant-current regulation, cell preconditioning, cell temperature monitoring, advanced safety timers, automatic charge termination and charge status indication in space-saving, 10-pin MSOP packages. The MCP73841 and MCP73842 provide complete, fully-functional, stand-alone charge management solutions.

The MCP73843 and MCP73844 employ all the features of the MCP73841 and MCP73842, with the exception of the cell temperature monitor. The MCP73843 and MCP73844 are offered in 8-pin MSOP packages.

The MCP73841 and MCP73843 are designed for applications utilizing single-cell Lithium-Ion or Lithium-Polymer battery packs. Two preset voltage regulation options are available (4.1V and 4.2V) for use with either coke or graphite anodes. The MCP73841 and MCP73843 operate with an input voltage range of 4.5V to 12V.

The MCP73842 and MCP73844 are designed for applications utilizing dual series cell Lithium-Ion or Lithium-Polymer battery packs. Two preset voltage regulation options are available (8.2V and 8.4V). The MCP73842 and MCP73844 operate with an input voltage range of 8.7V to 12V.

The MCP7384X family of devices are fully specified over the ambient temperature range of  $-40^{\circ}\text{C}$  to  $+85^{\circ}\text{C}$ .

### Package Types



# MCP73841/2/3/4

## Functional Block Diagram



## 1.0 ELECTRICAL CHARACTERISTICS

### Absolute Maximum Ratings †

$V_{DD}$ .....	13.5V
All inputs and outputs w.r.t. $V_{SS}$ .....	-0.3 to ( $V_{DD}+0.3$ )V
Current at DRV Pin .....	$\pm 4$ mA
Current at STAT1 Pin .....	$\pm 30$ mA
Maximum Junction Temperature, $T_J$ .....	150°C
Storage temperature .....	-65°C to +150°C
ESD protection on all pins:	
Human Body Model (1.5 k $\Omega$ in Series with 100 pF).....	$\geq 2$ kV
Machine Model (200 pF, No Series Resistance) .....	200V

**\*Notice:** Stresses above those listed under “Maximum Ratings” may cause permanent damage to the device. This is a stress rating only and functional operation of the device at those or any other conditions above those indicated in the operational listings of this specification is not implied. Exposure to maximum rating conditions for extended periods may affect device reliability.

### DC CHARACTERISTICS

**Electrical Specifications:** Unless otherwise indicated, all limits apply for  $V_{DD} = [V_{REG}(Typ)+0.3V]$  to 12V,  $T_A = -40^\circ\text{C}$  to  $+85^\circ\text{C}$ . Typical values are at  $+25^\circ\text{C}$ ,  $V_{DD} = [V_{REG}(Typ) + 1V]$ .

Parameters	Sym	Min	Typ	Max	Units	Conditions
<b>Supply Input</b>						
Supply Voltage	$V_{DD}$					
MCP73841, MCP73843		4.5	–	12	V	
MCP73842, MCP73844		8.7	–	12	V	
Supply Current	$I_{SS}$	–	0.25	4	$\mu\text{A}$	Disabled Operating $V_{DD} = V_{REG}(Typ)+1V$
		–	0.75	4	mA	
UVLO Start Threshold	$V_{START}$					
MCP73841, MCP73843		4.25	4.45	4.60	V	$V_{DD}$ Low-to-High
MCP73842, MCP73844		8.45	8.65	8.90	V	$V_{DD}$ Low-to-High
UVLO Stop Threshold	$V_{STOP}$					
MCP73841, MCP73843		4.20	4.40	4.55	V	$V_{DD}$ High-to-Low
MCP73842, MCP73844		8.40	8.60	8.85	V	$V_{DD}$ High-to-Low
<b>Voltage Regulation (Constant-Voltage Mode)</b>						
Regulated Output Voltage	$V_{REG}$					
MCP73841-4.1, MCP73843-4.1		4.079	4.1	4.121	V	$V_{DD} = [V_{REG}(Typ)+1V]$ , $I_{OUT} = 10$ mA, $T_A = -5^\circ\text{C}$ to $+55^\circ\text{C}$
MCP73841-4.2, MCP73843-4.2		4.179	4.2	4.221	V	$V_{DD} = [V_{REG}(Typ)+1V]$ , $I_{OUT} = 10$ mA, $T_A = -5^\circ\text{C}$ to $+55^\circ\text{C}$
MCP73842-8.2, MCP73844-8.2		8.159	8.2	8.241	V	$V_{DD} = [V_{REG}(Typ)+1V]$ , $I_{OUT} = 10$ mA, $T_A = -5^\circ\text{C}$ to $+55^\circ\text{C}$
MCP73842-8.4, MCP73844-8.4		8.358	8.4	8.442	V	$V_{DD} = [V_{REG}(Typ)+1V]$ , $I_{OUT} = 10$ mA, $T_A = -5^\circ\text{C}$ to $+55^\circ\text{C}$
Line Regulation	$ \Delta V_{BAT}/V_{BAT} /\Delta V_{DD}$	–	0.025	0.25	%/V	$V_{DD} = [V_{REG}(Typ)+1V]$ to 12V, $I_{OUT} = 10$ mA
Load Regulation	$ \Delta V_{BAT} /V_{BAT}$	–	0.01	0.25	%	$I_{OUT} = 10$ mA to 150 mA, $V_{DD} = [V_{REG}(Typ)+1V]$
Supply Ripple Attenuation	PSRR	–	-58	–	dB	$I_{OUT} = 10$ mA, 100 Hz
		–	-42	–	dB	$I_{OUT} = 10$ mA, 1 kHz
		–	-30	–	dB	$I_{OUT} = 10$ mA, 10 kHz
Output Reverse Leakage Current	$I_{DISCHARGE}$	–	0.4	1	$\mu\text{A}$	$V_{DD}$ Floating, $V_{BAT} = V_{REG}(Typ)$
<b>Current Regulation (Fast Charge Constant-Current Mode)</b>						
Fast Charge Current Regulation Threshold	$V_{FCS}$	100	110	120	mV	$V_{DD} - V_{SENSE}$ , $T_A = -5^\circ\text{C}$ to $+55^\circ\text{C}$

# MCP73841/2/3/4

## DC CHARACTERISTICS (CONTINUED)

<b>Electrical Specifications:</b> Unless otherwise indicated, all limits apply for $V_{DD} = [V_{REG}(Typ)+0.3V]$ to 12V, $T_A = -40^{\circ}C$ to $+85^{\circ}C$ . Typical values are at $+25^{\circ}C$ , $V_{DD} = [V_{REG}(Typ) + 1V]$ .						
Parameters	Sym	Min	Typ	Max	Units	Conditions
<b>Preconditioning Current Regulation (Trickle Charge Constant-Current Mode)</b>						
Precondition Current Regulation Threshold	$V_{PCS}$	5	10	15	mV	$V_{DD} - V_{SENSE}$ , $T_A = -5^{\circ}C$ to $+55^{\circ}C$
Precondition Threshold Voltage	$V_{PTH}$	2.70	2.80	2.90	V	$V_{BAT}$ Low-to-High
MCP73841-4.1, MCP73843-4.1		2.75	2.85	2.95	V	$V_{BAT}$ Low-to-High
MCP73841-4.2, MCP73843-4.2		5.40	5.60	5.80	V	$V_{BAT}$ Low-to-High
MCP73842-8.2, MCP73844-8.2		5.50	5.70	5.90	V	$V_{BAT}$ Low-to-High
MCP73842-8.4, MCP73844-8.4						
<b>Charge Termination</b>						
Charge Termination Threshold	$V_{TCS}$	4	7	10	mV	$V_{DD} - V_{SENSE}$ , $T_A = -5^{\circ}C$ to $+55^{\circ}C$
<b>Automatic Recharge</b>						
Recharge Threshold Voltage	$V_{RTH}$	$V_{REG}^-$ 300 mV	$V_{REG}^-$ 200 mV	$V_{REG}^-$ 100 mV	V	$V_{BAT}$ High-to-Low
MCP73841, MCP73843		$V_{REG}^-$ 600 mV	$V_{REG}^-$ 400 mV	$V_{REG}^-$ 200 mV	V	$V_{BAT}$ High-to-Low
MCP73842, MCP73844						
<b>External MOSFET Gate Drive</b>						
Gate Drive Current	$I_{DRV}$	-	2	-	mA	Sink, CV Mode
		-	-0.5	-	mA	Source, CV Mode
Gate Drive Minimum Voltage	$V_{DRVMIN}$	-	-	1.0	V	$V_{DD} = 4.5V$
Gate - Source Clamp Voltage	$V_{GS}$	-7.0	-	-4.5	V	$V_{DD} = 12.0V$
<b>Thermistor Reference - MCP73841, MCP73842</b>						
Thermistor Reference Output Voltage	$V_{THREF}$	2.475	2.55	2.625	V	$T_A = +25^{\circ}C$ , $V_{DD} = V_{REG}(Typ)+1V$ , $I_{THREF} = 0$ mA
Temperature Coefficient	$TC_{THREF}$	-	$\pm 50$	-	ppm/ $^{\circ}C$	
Thermistor Reference Source Current	$I_{THREF}$	200	-	-	$\mu A$	
Thermistor Reference Line Regulation	$ \frac{\Delta V_{THREF}}{V_{THREF}}  / \frac{\Delta V_{DD}}{V_{DD}}$	-	0.1	0.25	%/V	$V_{DD} = [V_{REG}(Typ)+1V]$ to 12V
Thermistor Reference Load Regulation	$\frac{\Delta V_{THREF}}{V_{THREF}}$	-	0.01	0.10	%	$I_{THREF} = 0$ mA to 0.20 mA
<b>Thermistor Comparator - MCP73841, MCP73842</b>						
Upper Trip Threshold	$V_{T1}$	1.18	1.25	1.32	V	
Upper Trip Point Hysteresis	$V_{T1HYS}$	-	-50	-	mV	
Lower Trip Threshold	$V_{T2}$	0.59	0.62	0.66	V	
Lower Trip Point Hysteresis	$V_{T2HYS}$	-	80	-	mV	
Input Bias Current	$ I_{BIAS} $	-	-	2	$\mu A$	
<b>Status Indicator</b>						
Sink Current	$I_{SINK}$	4	7	12	mA	
Low Output Voltage	$V_{OL}$	-	200	400	mV	$I_{SINK} = 1$ mA
Input Leakage Current	$I_{LK}$	-	0.01	1	$\mu A$	$I_{SINK} = 0$ mA, $V_{STAT1} = 12V$

## DC CHARACTERISTICS (CONTINUED)

**Electrical Specifications:** Unless otherwise indicated, all limits apply for  $V_{DD} = [V_{REG}(Typ)+0.3V]$  to 12V,  $T_A = -40^{\circ}C$  to  $+85^{\circ}C$ . Typical values are at  $+25^{\circ}C$ ,  $V_{DD} = [V_{REG}(Typ) + 1V]$ .

Parameters	Sym	Min	Typ	Max	Units	Conditions
<b>Enable Input</b>						
Input High-Voltage Level	$V_{IH}$	1.4	-	-	V	
Input Low-Voltage Level	$V_{IL}$	-	-	0.8	V	
Input Leakage Current	$I_{LK}$	-	0.01	1	$\mu A$	$V_{ENABLE} = 12V$

## AC CHARACTERISTICS

**Electrical Specifications:** Unless otherwise indicated, all limits apply for  $V_{DD} = [V_{REG}(Typ)+0.3V]$  to 12V,  $T_A = -40^{\circ}C$  to  $+85^{\circ}C$ . Typical values are at  $+25^{\circ}C$ ,  $V_{DD} = [V_{REG}(Typ)+1V]$ .

Parameters	Sym	Min	Typ	Max	Units	Conditions
UVLO Start Delay	$t_{START}$	-	-	5	msec	$V_{DD}$ Low-to-High
<b>Current Regulation</b>						
Transition Time Out of Preconditioning	$t_{DELAY}$	-	-	1	msec	$V_{BAT} < V_{PTH}$ to $V_{BAT} > V_{PTH}$
Current Rise Time Out of Preconditioning	$t_{RISE}$	-	-	1	msec	$I_{OUT}$ Rising to 90% of $I_{REG}$
Fast Charge Safety Timer Period	$t_{FAST}$	1.1	1.5	1.9	Hours	$C_{TIMER} = 0.1 \mu F$
<b>Preconditioning Current Regulation</b>						
Preconditioning Charge Safety Timer Period	$t_{PRECON}$	45	60	75	Minutes	$C_{TIMER} = 0.1 \mu F$
<b>Charge Termination</b>						
Elapsed Time Termination Period	$t_{TERM}$	2.2	3.0	3.8	Hours	$C_{TIMER} = 0.1 \mu F$
<b>Status Indicators</b>						
Status Output turn-off	$t_{OFF}$	-	-	200	$\mu sec$	$I_{SINK} = 10 \text{ mA to } 0 \text{ mA}$
Status Output turn-on	$t_{ON}$	-	-	200	$\mu sec$	$I_{SINK} = 0 \text{ mA to } 10 \text{ mA}$

## TEMPERATURE SPECIFICATIONS

**Electrical Specifications:** Unless otherwise specified, all limits apply for  $V_{DD} = [V_{REG}(Typ)+0.3V]$  to 12V. Typical values are at  $+25^{\circ}C$ ,  $V_{DD} = [V_{REG}(Typ)+1.0V]$ .

Parameters	Sym	Min	Typ	Max	Units	Conditions
<b>Temperature Ranges</b>						
Specified Temperature Range	$T_A$	-40		+85	$^{\circ}C$	
Operating Temperature Range	$T_A$	-40		+125	$^{\circ}C$	
Storage Temperature Range	$T_A$	-65		+150	$^{\circ}C$	
<b>Thermal Package Resistances</b>						
Thermal Resistance, MSOP-10	$\theta_{JA}$		113		$^{\circ}C/W$	4-Layer JC51-7 Standard Board, Natural Convection
Thermal Resistance, MSOP-8	$\theta_{JA}$		206		$^{\circ}C/W$	Single-Layer SEMI G42-88 Board, Natural Convection

# MCP73841/2/3/4

## 2.0 TYPICAL PERFORMANCE CURVES

**Note:** The graphs and tables provided following this note are a statistical summary based on a limited number of samples and are provided for informational purposes only. The performance characteristics listed herein are not tested or guaranteed. In some graphs or tables, the data presented may be outside the specified operating range (e.g., outside specified power supply range) and therefore outside the warranted range.

**Note:** Unless otherwise indicated,  $V_{DD} = [V_{REG}(Typ) + 1V]$ ,  $I_{OUT} = 10\text{ mA}$  and  $T_A = +25^\circ\text{C}$ .



**FIGURE 2-1:** Battery Regulation Voltage ( $V_{BAT}$ ) vs. Charge Current ( $I_{OUT}$ ).



**FIGURE 2-4:** Supply Current ( $I_{SS}$ ) vs. Charge Current ( $I_{OUT}$ ).



**FIGURE 2-2:** Battery Regulation Voltage ( $V_{BAT}$ ) vs. Supply Voltage ( $V_{DD}$ ).



**FIGURE 2-5:** Supply Current ( $I_{SS}$ ) vs. Supply Voltage ( $V_{DD}$ ).



**FIGURE 2-3:** Battery Regulation Voltage ( $V_{BAT}$ ) vs. Supply Voltage ( $V_{DD}$ ).



**FIGURE 2-6:** Supply Current ( $I_{SS}$ ) vs. Supply Voltage ( $V_{DD}$ ).

**Note:** Unless otherwise indicated,  $V_{DD} = [V_{REG}(Typ) + 1V]$ ,  $I_{OUT} = 10\text{ mA}$  and  $T_A = +25^\circ\text{C}$ .



**FIGURE 2-7:** Battery Regulation Voltage ( $V_{BAT}$ ) vs. Charge Current ( $I_{OUT}$ ).



**FIGURE 2-10:** Supply Current ( $I_{SS}$ ) vs. Charge Current ( $I_{OUT}$ ).

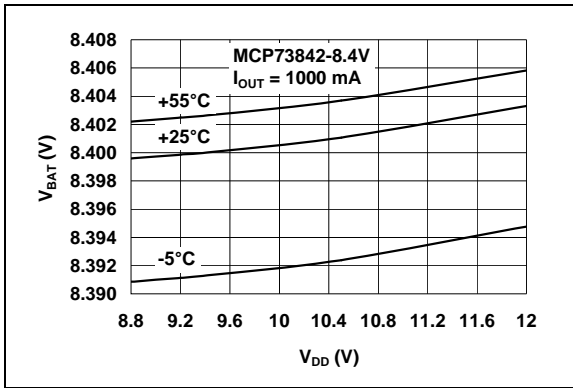

**FIGURE 2-8:** Battery Regulation Voltage ( $V_{BAT}$ ) vs. Supply Voltage ( $V_{DD}$ ).

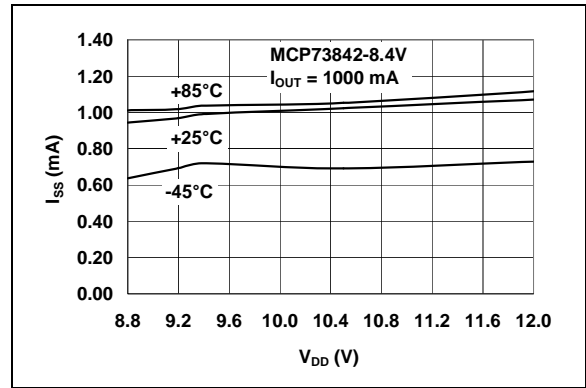

**FIGURE 2-11:** Supply Current ( $I_{SS}$ ) vs. Supply Voltage ( $V_{DD}$ ).



**FIGURE 2-9:** Battery Regulation Voltage ( $V_{BAT}$ ) vs. Supply Voltage ( $V_{DD}$ ).



**FIGURE 2-12:** Supply Current ( $I_{SS}$ ) vs. Supply Voltage ( $V_{DD}$ ).

# MCP73841/2/3/4

**Note:** Unless otherwise indicated,  $V_{DD} = [V_{REG}(Typ) + 1V]$ ,  $I_{OUT} = 10\text{ mA}$  and  $T_A = +25^\circ\text{C}$ .



**FIGURE 2-13:** Output Reverse Leakage Current ( $I_{DISCHARGE}$ ) vs. Battery Voltage ( $V_{BAT}$ ).



**FIGURE 2-16:** Output Reverse Leakage Current ( $I_{DISCHARGE}$ ) vs. Battery Voltage ( $V_{BAT}$ ).



**FIGURE 2-14:** Thermistor Reference Voltage ( $V_{THREF}$ ) vs. Thermistor Bias Current ( $I_{THREF}$ ).



**FIGURE 2-17:** Thermistor Reference Voltage ( $V_{THREF}$ ) vs. Thermistor Bias Current ( $I_{THREF}$ ).



**FIGURE 2-15:** Thermistor Reference Voltage ( $V_{THREF}$ ) vs. Supply Voltage ( $V_{DD}$ ).



**FIGURE 2-18:** Thermistor Reference Voltage ( $V_{THREF}$ ) vs. Supply Voltage ( $V_{DD}$ ).



**Note:** Unless otherwise indicated,  $V_{DD} = [V_{REG}(Typ) + 1V]$ ,  $I_{OUT} = 10\text{ mA}$  and  $T_A = +25^\circ\text{C}$ .



**FIGURE 2-19:** Line Transient Response.



**FIGURE 2-22:** Line Transient Response.



**FIGURE 2-20:** Load Transient Response.



**FIGURE 2-23:** Load Transient Response.



**FIGURE 2-21:** Power Supply Ripple Rejection.



**FIGURE 2-24:** Power Supply Ripple Rejection.

# MCP73841/2/3/4

## 3.0 PIN DESCRIPTIONS

The descriptions of the pins are listed in Table 3-1.

TABLE 3-1: PIN DESCRIPTION TABLE

MCP73841, MCP73842 Pin No.	MCP73843, MCP73844 Pin No.	Name	Function
1	1	SENSE	Charge Current Sense Input
2	2	V <sub>DD</sub>	Battery Management Input Supply
3	3	STAT1	Charge Status Output
4	4	EN	Logic Enable
5	—	THREF	Cell Temperature Sensor Bias
6	—	THERM	Cell Temperature Sensor Input
7	5	TIMER	Timer Set
8	6	V <sub>SS</sub>	Battery Management 0V Reference
9	7	V <sub>BAT</sub>	Battery Voltage Sense
10	8	DRV	Drive Output

### 3.1 Charge Current Sense Input (SENSE)

Charge current is sensed via the voltage developed across an external precision sense resistor. The sense resistor must be placed between the supply voltage (V<sub>DD</sub>) and the external pass transistor (Q1). A 220 mΩ sense resistor produces a fast charge current of 500 mA, typically.

### 3.2 Battery Management Input Supply (V<sub>DD</sub>)

A supply voltage of [V<sub>REG</sub>(Typ) + 0.3V] to 12V is recommended. Bypass to V<sub>SS</sub> with a minimum of 4.7 μF.

### 3.3 Charge Status Output (STAT1)

Current limited, open-drain drive for direct connection to a LED for charge status indication. Alternatively, a pull-up resistor can be applied for interfacing to a host microcontroller.

### 3.4 Logic Enable (EN)

Input to force charge termination, initiate charge, clear faults or disable automatic recharge.

### 3.5 Cell Temperature Sensor Bias (THREF)

Voltage reference to bias external thermistor for continuous cell temperature monitoring and prequalification.

### 3.6 Cell Temperature Sensor Input (THERM)

Input for an external thermistor for continuous cell-temperature monitoring and pre-qualification. Apply a voltage equal to 0.85V to disable temperature-sensing.

### 3.7 Timer Set (TIMER)

All safety timers are scaled by C<sub>TIMER</sub>/0.1 μF.

### 3.8 Battery Management 0V Reference (V<sub>SS</sub>)

Connect to negative terminal of battery.

### 3.9 Battery Voltage Sense (V<sub>BAT</sub>)

Voltage sense input. Connect to positive terminal of battery. Bypass to V<sub>SS</sub> with a minimum of 4.7 μF to ensure loop stability when the battery is disconnected. A precision internal resistor divider regulates the final voltage on this pin to V<sub>REG</sub>.

### 3.10 Drive Output (DRV)

Direct output drive of an external P-channel MOSFET for current and voltage regulation.

## 4.0 DEVICE OVERVIEW

The MCP7384X family of devices are highly advanced, linear charge management controllers. Figure 4-1 depicts the operational flow algorithm from charge initiation to completion and automatic recharge.

### 4.1 Charge Qualification and Preconditioning

Upon insertion of a battery or application of an external supply, the MCP7384X family of devices automatically perform a series of safety checks to qualify the charge. The input source voltage must be above the undervoltage lockout threshold, the enable pin must be above the logic-high level and the cell temperature monitor must be within the upper and lower thresholds. The cell temperature monitor applies to both the MCP73841 and MCP73842, with the qualification parameters being continuously monitored. Deviation beyond the limits automatically suspends or terminates the charge cycle.

Once the qualification parameters have been met, the MCP7384X initiates a charge cycle. The charge status output is pulled low throughout the charge cycle (see Table 5-1 for charge status outputs). If the battery voltage is below the preconditioning threshold ( $V_{PTH}$ ), the MCP7384X preconditions the battery with a trickle-charge. The preconditioning current is set to approximately 10% of the fast charge regulation current. The preconditioning trickle-charge safely replenishes deeply depleted cells and minimizes heat dissipation in the external pass transistor during the initial charge cycle. If the battery voltage has not exceeded the preconditioning threshold before the preconditioning timer has expired, a fault is indicated and the charge cycle is terminated.

### 4.2 Constant-Current Regulation – Fast Charge

Preconditioning ends and fast charging begins, when the battery voltage exceeds the preconditioning threshold. Fast charge regulates to a constant-current,  $I_{REG}$ , based on the supply voltage minus the voltage at the SENSE input ( $V_{FCS}$ ) developed by the drop across an external sense resistor ( $R_{SENSE}$ ). Fast charge continues until the battery voltage reaches the regulation voltage ( $V_{REG}$ ); or until the fast charge timer expires. In this case, a fault is indicated and the charge cycle is terminated.

### 4.3 Constant-Voltage Regulation

When the battery voltage reaches the regulation voltage ( $V_{REG}$ ), constant-voltage regulation begins. The MCP7384X monitors the battery voltage at the  $V_{BAT}$  pin. This input is tied directly to the positive terminal of the battery. The MCP7384X is offered in four fixed-voltage versions for single or dual series cell battery packs with either coke or graphite anodes:

- 4.1V (MCP73841-4.1, MCP73843-4.1)
- 4.2V (MCP73841-4.2, MCP73843-4.2)
- 8.2V (MCP73842-8.2, MCP73844-8.2)
- 8.4V (MCP73842-8.4, MCP73844-8.4)

### 4.4 Charge Cycle Completion and Automatic Re-Charge

The MCP7384X monitors the charging current during the constant-voltage regulation phase. The charge cycle is considered complete when the charge current has diminished below approximately 7% of the regulation current ( $I_{REG}$ ) or the elapsed timer has expired.

The MCP7384X automatically begins a new charge cycle when the battery voltage falls below the recharge threshold ( $V_{RTH}$ ), assuming all the qualification parameters are met.



**FIGURE 4-1:** Operational Flow Algorithm - MCP73841 and MCP73842.

## 5.0 DETAILED DESCRIPTION

### 5.1 Analog Circuitry

#### 5.1.1 CHARGE CURRENT SENSE INPUT (SENSE)

Fast charge current regulation is maintained by the voltage drop developed across an external sense resistor ( $R_{SENSE}$ ) applied to the SENSE input pin. The following formula calculates the value for  $R_{SENSE}$ :

$$R_{SENSE} = \frac{V_{FCS}}{I_{REG}}$$

where:  
 $I_{REG}$  is the desired fast charge current in amps

The preconditioning trickle-charge current and the charge termination current are scaled to approximately 10% and 7% of  $I_{REG}$ , respectively.

#### 5.1.2 BATTERY MANAGEMENT INPUT SUPPLY ( $V_{DD}$ )

The  $V_{DD}$  input is the input supply to the MCP7384X. The MCP7384X automatically enters a power-down mode if the voltage on the  $V_{DD}$  input falls below the undervoltage lockout voltage ( $V_{STOP}$ ). This feature prevents draining the battery pack when the  $V_{DD}$  supply is not present.

#### 5.1.3 CELL TEMPERATURE SENSOR BIAS (THREF)

A 2.55V voltage reference is provided to bias an external thermistor for continuous cell temperature monitoring and pre-qualification. A ratio metric window comparison is performed at threshold levels of  $V_{THREF}/2$  and  $V_{THREF}/4$ . Cell temperature monitoring is provided by both the MCP73841 and MCP73842.

#### 5.1.4 CELL TEMPERATURE SENSOR INPUT (THERM)

The MCP73841 and MCP73842 continuously monitor temperature by comparing the voltage between the THERM input and  $V_{SS}$  with the upper and lower temperature thresholds. A negative or positive temperature coefficient (NTC or PTC) thermistor and an external voltage divider typically develop this voltage. The temperature-sensing circuit has its own reference, to which it performs a ratio metric comparison. Therefore, it is immune to fluctuations in the supply input ( $V_{DD}$ ). The temperature-sensing circuit is removed from the system when  $V_{DD}$  is not applied, eliminating additional discharge of the battery pack.

Figure 6-1 depicts a typical application circuit with connection of the THERM input. The resistor values of  $R_{T1}$  and  $R_{T2}$  are calculated with the following equations.

For NTC thermistors:

$$R_{T1} = \frac{2 \times R_{COLD} \times R_{HOT}}{R_{COLD} - R_{HOT}}$$

$$R_{T2} = \frac{2 \times R_{COLD} \times R_{HOT}}{R_{COLD} - 3 \times R_{HOT}}$$

For PTC thermistors:

$$R_{T1} = \frac{2 \times R_{COLD} \times R_{HOT}}{R_{HOT} - R_{COLD}}$$

$$R_{T2} = \frac{2 \times R_{COLD} \times R_{HOT}}{R_{HOT} - 3 \times R_{COLD}}$$

where:  
 $R_{COLD}$  and  $R_{HOT}$  are the thermistor resistance values at the temperature window of interest.

Applying a voltage equal to 0.85V to the THERM input disables temperature monitoring.

#### 5.1.5 TIMER SET INPUT (TIMER)

The TIMER input programs the period of the safety timers by placing a timing capacitor ( $C_{TIMER}$ ) between the TIMER input pin and  $V_{SS}$ . Three safety timers are programmed via the timing capacitor.

The preconditioning safety timer period:

$$t_{PRECON} = \frac{C_{TIMER}}{0.1\mu F} \times 1.0Hours$$

The fast charge safety timer period:

$$t_{FAST} = \frac{C_{TIMER}}{0.1\mu F} \times 1.5Hours$$

The elapsed time termination period:

$$t_{TERM} = \frac{C_{TIMER}}{0.1\mu F} \times 3.0Hours$$

The preconditioning timer starts after qualification and resets when the charge cycle transitions to the constant-current, fast charge phase. The fast charge and elapsed timers start once the MCP7384X transitions from preconditioning. The fast charge timer resets when the charge cycle transitions to the constant-voltage phase. The elapsed timer will expire and terminate the charge if the sensed current does not diminish below the termination threshold.

# MCP73841/2/3/4

## 5.1.6 BATTERY VOLTAGE SENSE ( $V_{BAT}$ )

The MCP7384X monitors the battery voltage at the  $V_{BAT}$  pin. This input is tied directly to the positive terminal of the battery. The MCP7384X is offered in four fixed-voltage versions for single or dual series cell battery packs, with either coke or graphite anodes:

- 4.1V (MCP73841-4.1, MCP73843-4.1)
- 4.2V (MCP73841-4.2, MCP73843-4.2)
- 8.2V (MCP73842-8.2, MCP73844-8.2)
- 8.4V (MCP73842-8.4, MCP73844-8.4)

## 5.1.7 DRIVE OUTPUT (DRV)

The MCP7384X controls the gate drive to an external P-channel MOSFET. The P-channel MOSFET is controlled in the linear region regulating current and voltage supplied to the cell. The drive output is automatically turned off when the voltage on the  $V_{DD}$  input falls below the undervoltage lockout voltage ( $V_{STOP}$ ).

## 5.2 Digital Circuitry

### 5.2.1 CHARGE STATUS OUTPUT (STAT1)

A status output provides information on the state-of-charge. The current-limited, open-drain output can be used to illuminate an external LED. Optionally, a pull-up resistor can be used on the output for communication with a host microcontroller. Table 5-1 summarizes the state of the status output during a charge cycle.

**TABLE 5-1: STATUS OUTPUTS**

Charge Cycle State	Stat1
Qualification	OFF
Preconditioning	ON
Constant-Current Fast Charge	ON
Constant-Voltage	ON
Charge Complete	OFF
Safety Timer Fault	Flashing (1 Hz, 50% duty cycle)
Cell Temperature Invalid	Flashing (1 Hz, 50% duty cycle)
Disabled - Sleep mode	OFF
Battery Disconnected	OFF

The flashing rate (1 Hz) is based off a timer capacitor ( $C_{TIMER}$ ) of 0.1  $\mu$ F. The rate will vary based on the value of the timer capacitor.

### 5.2.2 LOGIC ENABLE (EN)

The logic-enable input pin (EN) can be used to terminate a charge anytime during the charge cycle, initiate a charge cycle or initiate a recharge cycle.

Applying a logic-high input signal to the EN pin, or tying it to the input source, enables the device. Applying a logic-low input signal disables the device and terminates a charge cycle. When disabled, the device's supply current is reduced to 0.25  $\mu$ A, typically.

## 6.0 APPLICATIONS

The MCP7384X is designed to operate in conjunction with either a host microcontroller or in stand-alone applications. The MCP7384X provides the preferred charge algorithm for Lithium-Ion and Lithium-Polymer

cells: constant-current followed by constant-voltage. Figure 6-1 depicts a typical stand-alone application circuit, while Figure 6-2 depicts the accompanying charge profile.

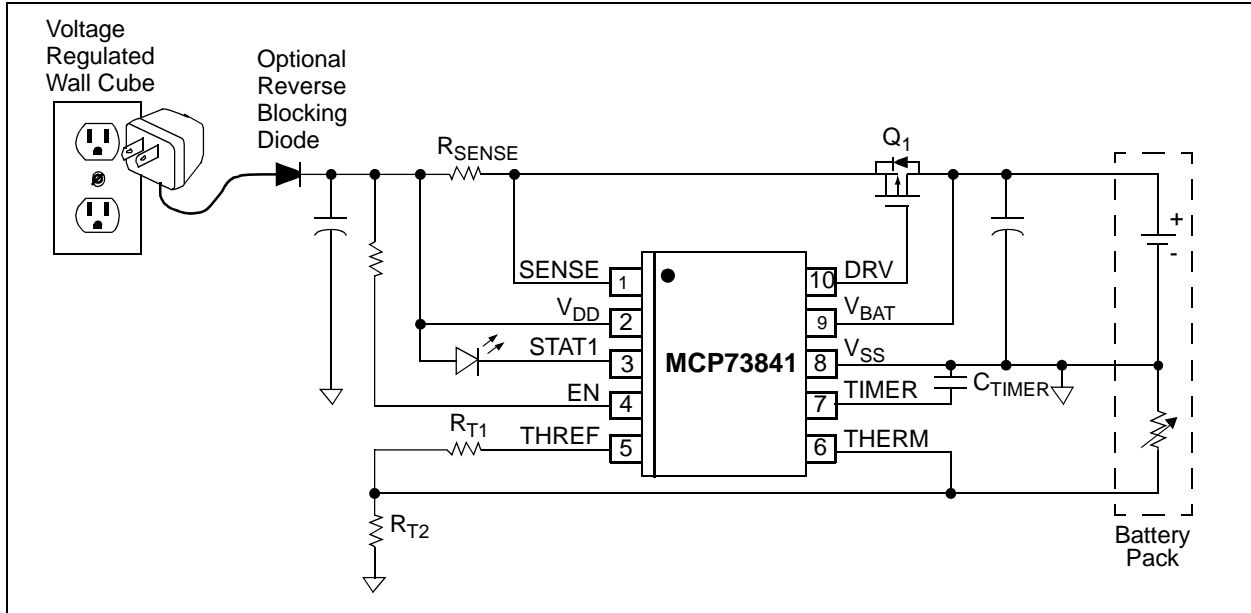

**FIGURE 6-1:** Typical Application Circuit.

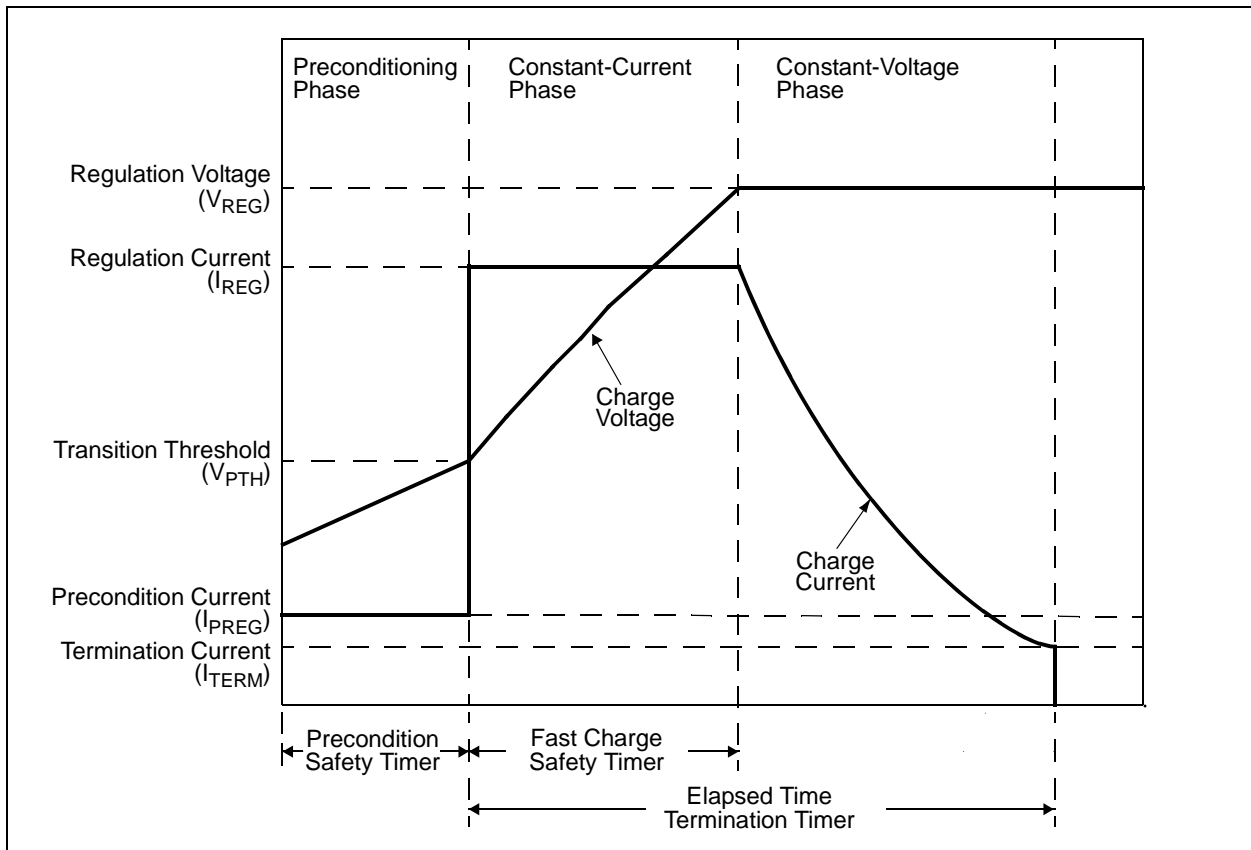

**FIGURE 6-2:** Typical Charge Profile.

# MCP73841/2/3/4

## 6.1 Application Circuit Design

Due to the low efficiency of linear charging, the most important factors are thermal design and cost, which are a direct function of the input voltage, output current and thermal impedance between the external P-channel pass transistor and the ambient cooling air. The worst-case situation occurs when the device has transitioned from the preconditioning phase to the constant-current phase. In this situation, the P-channel pass transistor has to dissipate the maximum power. A trade-off must be made between the charge current, cost and thermal requirements of the charger.

### 6.1.1 COMPONENT SELECTION

Selection of the external components in Figure 6-1 are crucial to the integrity and reliability of the charging system. The following discussion is intended to be a guide for the component selection process.

#### 6.1.1.1 Sense Resistor

The preferred fast charge current for Lithium-Ion cells is at the 1C rate, with an absolute maximum current at the 2C rate. For example, a 500 mAh battery pack has a preferred fast charge current of 500 mA. Charging at this rate provides the shortest charge cycle times without degradation to the battery pack performance or life.

The current sense resistor ( $R_{SENSE}$ ) is calculated by:

$$R_{SENSE} = \frac{V_{FCS}}{I_{REG}}$$

Where:  
 $I_{REG}$  is the desired fast charge current.

For the 500 mAh battery pack example, a standard value 220 m $\Omega$ , 1% resistor provides a typical fast charge current of 500 mA and a maximum fast charge current of 551 mA. Worst-case power dissipation in the sense resistor is:

$$PowerDissipation = 220m\Omega \times 551mA^2 = 66.8mW$$

A Panasonic<sup>®</sup> ERJ-6RQFR22V, 220 mW, 1%, 1/8W resistor in a standard 0805 package is more than sufficient for this application.

A larger value sense resistor will decrease the fast charge current and power dissipation in both the sense resistor and external pass transistor, but will increase charge cycle times. Design trade-offs must be considered to minimize space while maintaining the desired performance.

#### 6.1.1.2 External Pass Transistor

The external P-channel MOSFET is determined by the gate-to-source threshold voltage, input voltage, output voltage and fast charge current. Therefore, the selected P-channel MOSFET must satisfy the thermal and electrical design requirements.

#### Thermal Considerations

The worst-case power dissipation in the external pass transistor occurs when the input voltage is at the maximum and the device has transitioned from the preconditioning phase to the constant-current phase. In this case, the power dissipation is:

$$PowerDissipation = (V_{DDMAX} - V_{PTHMIN}) \times I_{REGMAX}$$

Where:

$V_{DDMAX}$  is the maximum input voltage.

$I_{REGMAX}$  is the maximum fast charge current.

$V_{PTHMIN}$  is the minimum transition threshold voltage.

Power dissipation with a 5V,  $\pm 10\%$  input voltage source, 220 m $\Omega$ , 1% sense resistor is:

$$PowerDissipation = (5.5V - 2.75V) \times 551mA = 1.52W$$

Utilizing a Fairchild<sup>™</sup> NDS8434 or an International Rectifier IRF7404 mounted on a 1in<sup>2</sup> pad of 2 oz. copper, the junction temperature rise is 75°C, approximately. This would allow for a maximum operating ambient temperature of 75°C.

By increasing the size of the copper pad, a higher ambient temperature can be realized, or a lower value sense resistor could be utilized.

Alternatively, different package options can be utilized for more or less power dissipation. Again, design trade-offs should be considered to minimize size while maintaining the desired performance.

#### Electrical Considerations

The gate-to-source threshold voltage and  $R_{DS(ON)}$  of the external P-channel MOSFET must be considered in the design phase.

The worst-case  $V_{GS}$  provided by the controller occurs when the input voltage is at the minimum and the fast charge current regulation threshold is at the maximum. The worst-case  $V_{GS}$  is:

$$V_{GS} = V_{DRVMAX} - (V_{DDMIN} - V_{FCSMAX})$$

Where:

$V_{DRVMAX}$  is the maximum sink voltage at the  $V_{DRV}$  output

$V_{DDMIN}$  is the minimum input voltage source

$V_{FCSMAX}$  is the maximum fast charge current regulation threshold



Worst-case  $V_{GS}$  with a 5V,  $\pm 10\%$  input voltage source and a maximum sink voltage of 1.0V is:

$$V_{GS} = 1.0V - (4.5V - 120mV) = -3.38V$$

At this worst-case ( $V_{GS}$ ) the  $R_{DS(ON)}$  of the MOSFET must be low enough as to not impede the performance of the charging system. The maximum allowable  $R_{DS(ON)}$  at the worst-case  $V_{GS}$  is:

$$R_{DS(ON)} = \frac{V_{DDMIN} - V_{FCSMAX} - V_{BATMAX}}{I_{REGMAX}}$$
$$R_{DS(ON)} = \frac{4.5V - 120(115)mV - 4.221V}{551(581)mA} = 288m\Omega$$

The Fairchild NDS8434 and International Rectifier IRF7404 both satisfy these requirements.

### 6.1.1.3 EXTERNAL CAPACITORS

The MCP7384X are stable with or without a battery load. In order to maintain good AC stability in the Constant-Voltage mode, a minimum capacitance of 4.7  $\mu$ F is recommended to bypass the  $V_{BAT}$  pin to  $V_{SS}$ . This capacitance provides compensation when there is no battery load. Additionally, the battery and interconnections appear inductive at high frequencies. These elements are in the control feedback loop during Constant-Voltage mode. Therefore, the bypass capacitance may be necessary to compensate for the inductive nature of the battery pack.

Virtually any good quality output filter capacitor can be used, independent of the capacitor's minimum ESR (Effective Series Resistance) value. The actual value of the capacitor and its associated ESR depends on the forward transconductance ( $g_m$ ) and capacitance of the external pass transistor. A 4.7  $\mu$ F tantalum or aluminum electrolytic capacitor at the output is usually sufficient to ensure stability for up to a 1A output current.

### 6.1.1.4 REVERSE-BLOCKING PROTECTION

The optional reverse-blocking protection diode, depicted in Figure 6-1, provides protection from a faulted or shorted input, or from a reversed-polarity input source. Without the protection diode, a faulted or shorted input would discharge the battery pack through the body diode of the external pass transistor.

If a reverse-protection diode is incorporated into the design, it should be chosen to handle the fast charge current continuously at the maximum ambient temperature. In addition, the reverse-leakage current of the diode should be kept as small as possible.

### 6.1.1.5 ENABLE INTERFACE

In the stand-alone configuration, the enable pin is generally tied to the input voltage. The MCP7384X automatically enters a Low-power mode when voltage on the  $V_{DD}$  input falls below the undervoltage lockout voltage ( $V_{STOP}$ ), reducing the battery drain current to 0.4  $\mu$ A, typically.

### 6.1.1.6 CHARGE STATUS INTERFACE

A status output provides information on the state of charge. The current-limited, open-drain output can be used to illuminate an external LED. Refer to Table 5-1 for a summary of the state of the status output during a charge cycle.

## 6.2 PCB Layout Issues

For optimum voltage regulation, place the battery pack as close as possible to the device's  $V_{BAT}$  and  $V_{SS}$  pins. This is recommended to minimize voltage drops along the high current-carrying PCB traces.

If the PCB layout is used as a heatsink, adding many vias around the external pass transistor can help conduct more heat to the back plane of the PCB, thus reducing the maximum junction temperature.

# MCP73841/2/3/4

## 7.0 PACKAGING INFORMATION

### 7.1 Package Marking Information

8-Lead MSOP (MCP73843, MCP73844)



Example:



10-Lead MSOP (MCP73841, MCP73842)



Example:

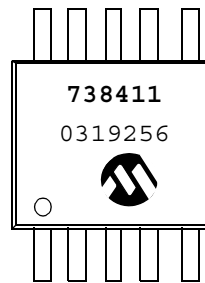

<b>Legend:</b>	XX...X	Customer-specific information
	Y	Year code (last digit of calendar year)
	YY	Year code (last 2 digits of calendar year)
	WW	Week code (week of January 1 is week '01')
	NNN	Alphanumeric traceability code
	(e3)	Pb-free JEDEC designator for Matte Tin (Sn)
	*	This package is Pb-free. The Pb-free JEDEC designator (e3) can be found on the outer packaging for this package.

**Note:** In the event the full Microchip part number cannot be marked on one line, it will be carried over to the next line, thus limiting the number of available characters for customer-specific information.

## 8-Lead Plastic Micro Small Outline Package (MS) (MSOP)

**Note:** For the most current package drawings, please see the Microchip Packaging Specification located at <http://www.microchip.com/packaging>

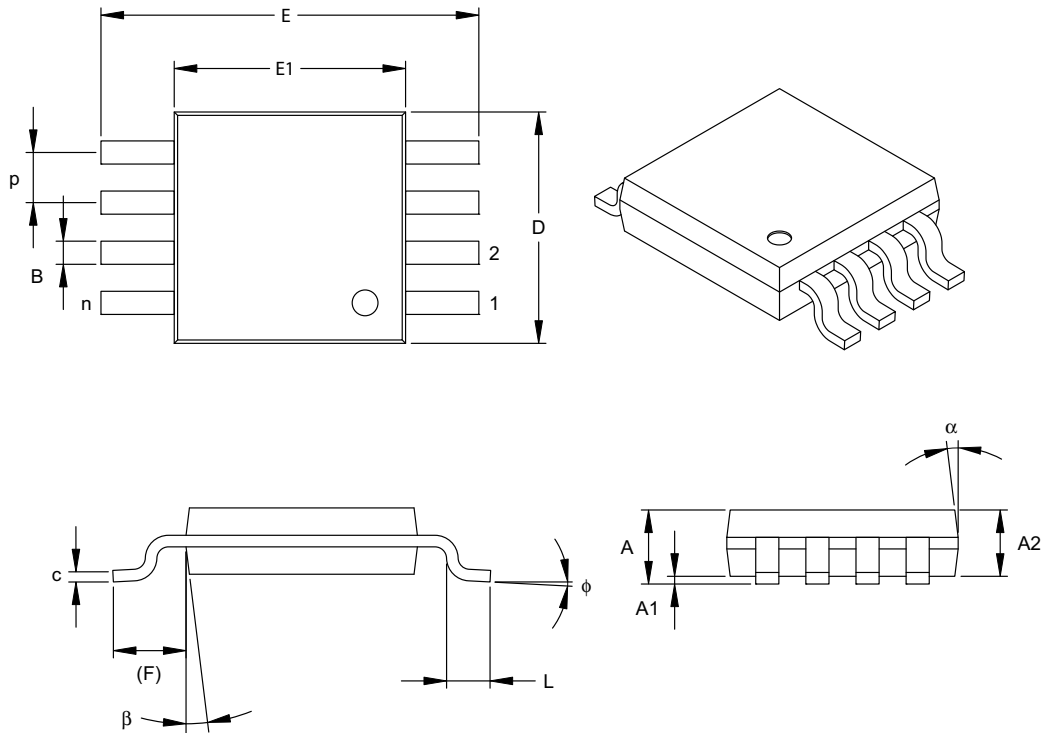

Dimension Limits	Units	INCHES			MILLIMETERS*		
		MIN	NOM	MAX	MIN	NOM	MAX
Number of Pins	n		8			8	
Pitch	P	.026 BSC			0.65 BSC		
Overall Height	A	-	-	.043	-	-	1.10
Molded Package Thickness	A2	.030	.033	.037	0.75	0.85	0.95
Standoff	A1	.000	-	.006	0.00	-	0.15
Overall Width	E	.193 TYP.			4.90 BSC		
Molded Package Width	E1	.118 BSC			3.00 BSC		
Overall Length	D	.118 BSC			3.00 BSC		
Foot Length	L	.016	.024	.031	0.40	0.60	0.80
Footprint (Reference)	F	.037 REF			0.95 REF		
Foot Angle	phi	0°	-	8°	0°	-	8°
Lead Thickness	c	.003	.006	.009	0.08	-	0.23
Lead Width	B	.009	.012	.016	0.22	-	0.40
Mold Draft Angle Top	alpha	5°	-	15°	5°	-	15°
Mold Draft Angle Bottom	beta	5°	-	15°	5°	-	15°

\*Controlling Parameter

Notes:

Dimensions D and E1 do not include mold flash or protrusions. Mold flash or protrusions shall not exceed .010" (0.254mm) per side.

JEDEC Equivalent: MO-187

Drawing No. C04-111

# MCP73841/2/3/4

## 10-Lead Plastic Micro Small Outline Package (UN) (MSOP)

**Note:** For the most current package drawings, please see the Microchip Packaging Specification located at <http://www.microchip.com/packaging>

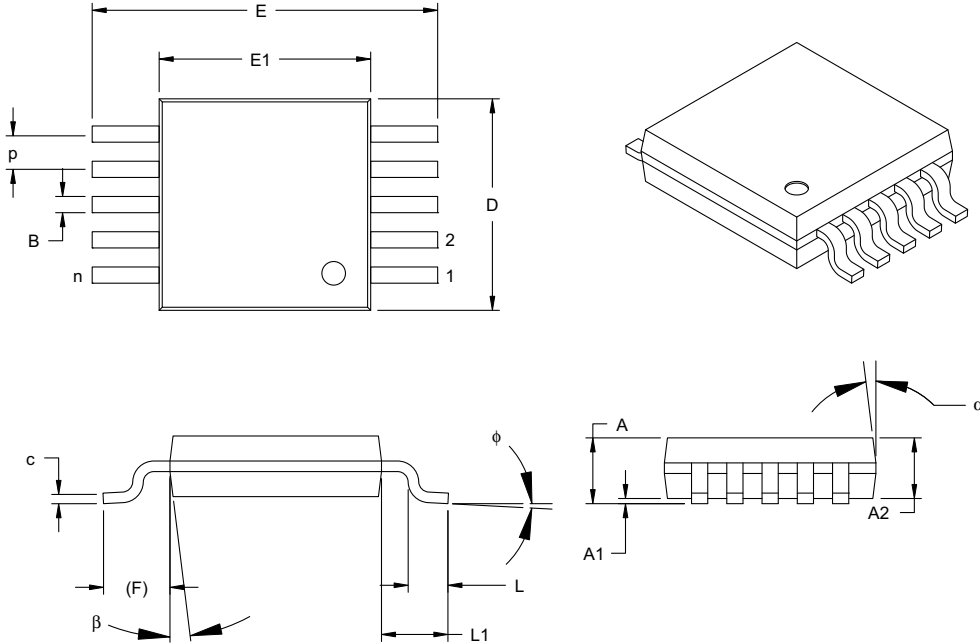

Dimension Limits	Units	INCHES			MILLIMETERS*		
		MIN	NOM	MAX	MIN	NOM	MAX
Number of Pins	n		10			10	
Pitch	P	.020 TYP			0.50 TYP.		
Overall Height	A	-	-	.043	-	-	1.10
Molded Package Thickness	A2	.030	.033	.037	0.75	0.85	0.95
Standoff	A1	.000	-	.006	0.00	-	0.15
Overall Width	E	.193 BSC			4.90 BSC		
Molded Package Width	E1	.118 BSC			3.00 BSC		
Overall Length	D	.118 BSC			3.00 BSC		
Foot Length	L	.016	.024	.031	0.40	0.60	0.80
Footprint	F	.037 REF			0.95 REF		
Foot Angle	$\phi$	0°	-	8°	0°	-	8°
Lead Thickness	c	.003	-	.009	0.08	-	0.23
Lead Width	B	.006	.009	.012	0.15	0.23	0.30
Mold Draft Angle Top	$\alpha$	5°	-	15°	5°	-	15°
Mold Draft Angle Bottom	$\beta$	5°	-	15°	5°	-	15°

\*Controlling Parameter

Notes:

Dimensions D and E1 do not include mold flash or protrusions. Mold flash or protrusions shall not exceed .010" (0.254mm) per side.

JEDEC Equivalent: MO-187

Drawing No. C04-021

## 8.0 REVISION HISTORY

### Revision D (January 2013)

Added a note to each package outline drawing.



## PRODUCT IDENTIFICATION SYSTEM

To order or obtain information, e.g., on pricing or delivery, refer to the factory or the listed sales office.

PART NO.	XXX	X	XX	
Device	Preset Voltage Options	Temperature Range	Package	
Device	MCP73841:	Single-cell charge controller with temperature monitor		
	MCP73841T:	Single-cell charge controller with temperature monitor, Tape and Reel		
	MCP73842:	Dual series cells charge controller with temperature monitor		
	MCP73842T:	Dual series cells charge controller with temperature monitor, Tape and Reel		
	MCP73843:	Single-cell charge controller		
	MCP73843T:	Single-cell charge controller, Tape and Reel		
	MCP73844:	Dual series cells charge controller		
	MCP73844T:	Dual series cells charge controller, Tape and Reel		
Preset Voltage Regulation Options	410 = 4.1V 420 = 4.2V 820 = 8.2V 840 = 8.4V			
Temperature Range	I = -40°C to +85°C (Industrial)			
Package	MS = Plastic Micro Small Outline (MSOP), 8-lead UN = Plastic Micro Small Outline (MSOP), 10-lead			

Examples:	
a)	MCP73841-410I/UN: 4.1V Preset Voltage
b)	MCP73841T-410I/UN: 4.1V Preset Voltage, Tape and Reel
c)	MCP73841-420I/UN: 4.2V Preset Voltage
d)	MCP73841T-420I/UN: 4.2V Preset Voltage, Tape and Reel
a)	MCP73842-820I/UN: 8.2V Preset Voltage
b)	MCP73842T-820I/UN: 8.2V Preset Voltage, Tape and Reel
c)	MCP73842-840I/UN: 8.4V Preset Voltage
d)	MCP73842T-840I/UN: 8.4V Preset Voltage, Tape and Reel
a)	MCP73843-410I/MS: 4.1V Preset Voltage
b)	MCP73843T-410I/MS: 4.1V Preset Voltage, Tape and Reel
c)	MCP73843-420I/MS: 4.2V Preset Voltage
d)	MCP73843T-420I/MS: 4.2V Preset Voltage, Tape and Reel
a)	MCP73844-820I/MS: 8.2V Preset Voltage
b)	MCP73844T-820I/MS: 8.2V Preset Voltage, Tape and Reel
c)	MCP73844-840I/MS: 8.4V Preset Voltage
d)	MCP73844T-840I/MS: 8.4V Preset Voltage, Tape and Reel

## Sales and Support

### Data Sheets

Products supported by a preliminary Data Sheet may have an errata sheet describing minor operational differences and recommended workarounds. To determine if an errata sheet exists for a particular device, please contact one of the following:

1. Your local Microchip sales office
2. The Microchip Worldwide Site ([www.microchip.com](http://www.microchip.com))

Please specify which device, revision of silicon and Data Sheet (include Literature #) you are using.

### Customer Notification System

Register on our web site ([www.microchip.com/cn](http://www.microchip.com/cn)) to receive the most current information on our products.

# MCP73841/2/3/4

---

NOTES:



---

---

**Note the following details of the code protection feature on Microchip devices:**

- Microchip products meet the specification contained in their particular Microchip Data Sheet.
- Microchip believes that its family of products is one of the most secure families of its kind on the market today, when used in the intended manner and under normal conditions.
- There are dishonest and possibly illegal methods used to breach the code protection feature. All of these methods, to our knowledge, require using the Microchip products in a manner outside the operating specifications contained in Microchip's Data Sheets. Most likely, the person doing so is engaged in theft of intellectual property.
- Microchip is willing to work with the customer who is concerned about the integrity of their code.
- Neither Microchip nor any other semiconductor manufacturer can guarantee the security of their code. Code protection does not mean that we are guaranteeing the product as “unbreakable.”

Code protection is constantly evolving. We at Microchip are committed to continuously improving the code protection features of our products. Attempts to break Microchip's code protection feature may be a violation of the Digital Millennium Copyright Act. If such acts allow unauthorized access to your software or other copyrighted work, you may have a right to sue for relief under that Act.

---

Information contained in this publication regarding device applications and the like is provided only for your convenience and may be superseded by updates. It is your responsibility to ensure that your application meets with your specifications. MICROCHIP MAKES NO REPRESENTATIONS OR WARRANTIES OF ANY KIND WHETHER EXPRESS OR IMPLIED, WRITTEN OR ORAL, STATUTORY OR OTHERWISE, RELATED TO THE INFORMATION, INCLUDING BUT NOT LIMITED TO ITS CONDITION, QUALITY, PERFORMANCE, MERCHANTABILITY OR FITNESS FOR PURPOSE. Microchip disclaims all liability arising from this information and its use. Use of Microchip devices in life support and/or safety applications is entirely at the buyer's risk, and the buyer agrees to defend, indemnify and hold harmless Microchip from any and all damages, claims, suits, or expenses resulting from such use. No licenses are conveyed, implicitly or otherwise, under any Microchip intellectual property rights.

#### **Trademarks**

The Microchip name and logo, the Microchip logo, dsPIC, FlashFlex, KEELOQ, KEELOQ logo, MPLAB, PIC, PICmicro, PICSTART, PIC<sup>32</sup> logo, rPIC, SST, SST Logo, SuperFlash and UNI/O are registered trademarks of Microchip Technology Incorporated in the U.S.A. and other countries.

FilterLab, Hampshire, HI-TECH C, Linear Active Thermistor, MTP, SEEVAL and The Embedded Control Solutions Company are registered trademarks of Microchip Technology Incorporated in the U.S.A.

Silicon Storage Technology is a registered trademark of Microchip Technology Inc. in other countries.

Analog-for-the-Digital Age, Application Maestro, BodyCom, chipKIT, chipKIT logo, CodeGuard, dsPICDEM, dsPICDEM.net, dsPICworks, dsSPEAK, ECAN, ECONOMONITOR, FanSense, HI-TIDE, In-Circuit Serial Programming, ICSP, Mindi, MiWi, MPASM, MPF, MPLAB Certified logo, MPLIB, MPLINK, mTouch, Omniclient Code Generation, PICC, PICC-18, PICDEM, PICDEM.net, PICkit, PICTail, REAL ICE, rLAB, Select Mode, SQI, Serial Quad I/O, Total Endurance, TSHARC, UniWinDriver, WiperLock, ZENA and Z-Scale are trademarks of Microchip Technology Incorporated in the U.S.A. and other countries.

SQTP is a service mark of Microchip Technology Incorporated in the U.S.A.

GestIC and ULPP are registered trademarks of Microchip Technology Germany II GmbH & Co. & KG, a subsidiary of Microchip Technology Inc., in other countries.

All other trademarks mentioned herein are property of their respective companies.

© 2003-2013, Microchip Technology Incorporated, Printed in the U.S.A., All Rights Reserved.

 Printed on recycled paper.

ISBN: 9781620769027

**QUALITY MANAGEMENT SYSTEM**  
**CERTIFIED BY DNV**  
**== ISO/TS 16949 ==**

*Microchip received ISO/TS-16949:2009 certification for its worldwide headquarters, design and wafer fabrication facilities in Chandler and Tempe, Arizona; Gresham, Oregon and design centers in California and India. The Company's quality system processes and procedures are for its PIC<sup>®</sup> MCUs and dsPIC<sup>®</sup> DSCs, KEELOQ<sup>®</sup> code hopping devices, Serial EEPROMs, microperipherals, nonvolatile memory and analog products. In addition, Microchip's quality system for the design and manufacture of development systems is ISO 9001:2000 certified.*



# MICROCHIP

## Worldwide Sales and Service

### AMERICAS

**Corporate Office**  
2355 West Chandler Blvd.  
Chandler, AZ 85224-6199  
Tel: 480-792-7200  
Fax: 480-792-7277  
Technical Support:  
<http://www.microchip.com/support>  
Web Address:  
[www.microchip.com](http://www.microchip.com)

**Atlanta**  
Duluth, GA  
Tel: 678-957-9614  
Fax: 678-957-1455

**Boston**  
Westborough, MA  
Tel: 774-760-0087  
Fax: 774-760-0088

**Chicago**  
Itasca, IL  
Tel: 630-285-0071  
Fax: 630-285-0075

**Cleveland**  
Independence, OH  
Tel: 216-447-0464  
Fax: 216-447-0643

**Dallas**  
Addison, TX  
Tel: 972-818-7423  
Fax: 972-818-2924

**Detroit**  
Farmington Hills, MI  
Tel: 248-538-2250  
Fax: 248-538-2260

**Indianapolis**  
Noblesville, IN  
Tel: 317-773-8323  
Fax: 317-773-5453

**Los Angeles**  
Mission Viejo, CA  
Tel: 949-462-9523  
Fax: 949-462-9608

**Santa Clara**  
Santa Clara, CA  
Tel: 408-961-6444  
Fax: 408-961-6445

**Toronto**  
Mississauga, Ontario,  
Canada  
Tel: 905-673-0699  
Fax: 905-673-6509

### ASIA/PACIFIC

**Asia Pacific Office**  
Suites 3707-14, 37th Floor  
Tower 6, The Gateway  
Harbour City, Kowloon  
Hong Kong  
Tel: 852-2401-1200  
Fax: 852-2401-3431

**Australia - Sydney**  
Tel: 61-2-9868-6733  
Fax: 61-2-9868-6755

**China - Beijing**  
Tel: 86-10-8569-7000  
Fax: 86-10-8528-2104

**China - Chengdu**  
Tel: 86-28-8665-5511  
Fax: 86-28-8665-7889

**China - Chongqing**  
Tel: 86-23-8980-9588  
Fax: 86-23-8980-9500

**China - Hangzhou**  
Tel: 86-571-2819-3187  
Fax: 86-571-2819-3189

**China - Hong Kong SAR**  
Tel: 852-2943-5100  
Fax: 852-2401-3431

**China - Nanjing**  
Tel: 86-25-8473-2460  
Fax: 86-25-8473-2470

**China - Qingdao**  
Tel: 86-532-8502-7355  
Fax: 86-532-8502-7205

**China - Shanghai**  
Tel: 86-21-5407-5533  
Fax: 86-21-5407-5066

**China - Shenyang**  
Tel: 86-24-2334-2829  
Fax: 86-24-2334-2393

**China - Shenzhen**  
Tel: 86-755-8864-2200  
Fax: 86-755-8203-1760

**China - Wuhan**  
Tel: 86-27-5980-5300  
Fax: 86-27-5980-5118

**China - Xian**  
Tel: 86-29-8833-7252  
Fax: 86-29-8833-7256

**China - Xiamen**  
Tel: 86-592-2388138  
Fax: 86-592-2388130

**China - Zhuhai**  
Tel: 86-756-3210040  
Fax: 86-756-3210049

### ASIA/PACIFIC

**India - Bangalore**  
Tel: 91-80-3090-4444  
Fax: 91-80-3090-4123

**India - New Delhi**  
Tel: 91-11-4160-8631  
Fax: 91-11-4160-8632

**India - Pune**  
Tel: 91-20-2566-1512  
Fax: 91-20-2566-1513

**Japan - Osaka**  
Tel: 81-6-6152-7160  
Fax: 81-6-6152-9310

**Japan - Tokyo**  
Tel: 81-3-6880-3770  
Fax: 81-3-6880-3771

**Korea - Daegu**  
Tel: 82-53-744-4301  
Fax: 82-53-744-4302

**Korea - Seoul**  
Tel: 82-2-554-7200  
Fax: 82-2-558-5932 or  
82-2-558-5934

**Malaysia - Kuala Lumpur**  
Tel: 60-3-6201-9857  
Fax: 60-3-6201-9859

**Malaysia - Penang**  
Tel: 60-4-227-8870  
Fax: 60-4-227-4068

**Philippines - Manila**  
Tel: 63-2-634-9065  
Fax: 63-2-634-9069

**Singapore**  
Tel: 65-6334-8870  
Fax: 65-6334-8850

**Taiwan - Hsin Chu**  
Tel: 886-3-5778-366  
Fax: 886-3-5770-955

**Taiwan - Kaohsiung**  
Tel: 886-7-213-7828  
Fax: 886-7-330-9305

**Taiwan - Taipei**  
Tel: 886-2-2508-8600  
Fax: 886-2-2508-0102

**Thailand - Bangkok**  
Tel: 66-2-694-1351  
Fax: 66-2-694-1350

### EUROPE

**Austria - Wels**  
Tel: 43-7242-2244-39  
Fax: 43-7242-2244-393

**Denmark - Copenhagen**  
Tel: 45-4450-2828  
Fax: 45-4485-2829

**France - Paris**  
Tel: 33-1-69-53-63-20  
Fax: 33-1-69-30-90-79

**Germany - Munich**  
Tel: 49-89-627-144-0  
Fax: 49-89-627-144-44

**Italy - Milan**  
Tel: 39-0331-742611  
Fax: 39-0331-466781

**Netherlands - Drunen**  
Tel: 31-416-690399  
Fax: 31-416-690340

**Spain - Madrid**  
Tel: 34-91-708-08-90  
Fax: 34-91-708-08-91

**UK - Wokingham**  
Tel: 44-118-921-5869  
Fax: 44-118-921-5820

11/29/12

Компания «Океан Электроники» предлагает заключение долгосрочных отношений при поставках импортных электронных компонентов на взаимовыгодных условиях!

Наши преимущества:

- Поставка оригинальных импортных электронных компонентов напрямую с производств Америки, Европы и Азии, а так же с крупнейших складов мира;
- Широкая линейка поставок активных и пассивных импортных электронных компонентов (более 30 млн. наименований);
- Поставка сложных, дефицитных, либо снятых с производства позиций;
- Оперативные сроки поставки под заказ (от 5 рабочих дней);
- Экспресс доставка в любую точку России;
- Помощь Конструкторского Отдела и консультации квалифицированных инженеров;
- Техническая поддержка проекта, помощь в подборе аналогов, поставка прототипов;
- Поставка электронных компонентов под контролем ВП;
- Система менеджмента качества сертифицирована по Международному стандарту ISO 9001;
- При необходимости вся продукция военного и аэрокосмического назначения проходит испытания и сертификацию в лаборатории (по согласованию с заказчиком);
- Поставка специализированных компонентов военного и аэрокосмического уровня качества (Xilinx, Altera, Analog Devices, Intersil, Interpoint, Microsemi, Actel, Aeroflex, Peregrine, VPT, Syfer, Eurofarad, Texas Instruments, MS Kennedy, Miteq, Cobham, E2V, MA-COM, Hittite, Mini-Circuits, General Dynamics и др.);

Компания «Океан Электроники» является официальным дистрибьютором и эксклюзивным представителем в России одного из крупнейших производителей разъемов военного и аэрокосмического назначения «JONHON», а так же официальным дистрибьютором и эксклюзивным представителем в России производителя высокотехнологичных и надежных решений для передачи СВЧ сигналов «FORSTAR».



## JONHON

«JONHON» (основан в 1970 г.)

Разъемы специального, военного и аэрокосмического назначения:

(Применяются в военной, авиационной, аэрокосмической, морской, железнодорожной, горно- и нефтедобывающей отраслях промышленности)

«FORSTAR» (основан в 1998 г.)

ВЧ соединители, коаксиальные кабели,  
кабельные сборки и микроволновые компоненты:

(Применяются в телекоммуникациях гражданского и специального назначения, в средствах связи, РЛС, а так же военной, авиационной и аэрокосмической отраслях промышленности).



Телефон: 8 (812) 309-75-97 (многоканальный)

Факс: 8 (812) 320-03-32

Электронная почта: [ocean@oceanchips.ru](mailto:ocean@oceanchips.ru)

Web: <http://oceanchips.ru/>

Адрес: 198099, г. Санкт-Петербург, ул. Калинина, д. 2, корп. 4, лит. А