

Optocoupler, Phototransistor Output, with Base Connection

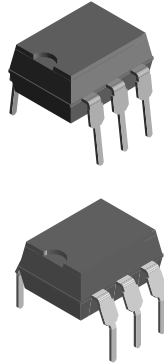

17186

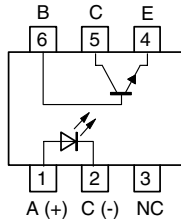

DESCRIPTION

The CNY75A/B/C/GA/GB/GC consists of a phototransistor optically coupled to a gallium arsenide infrared-emitting diode in a 6 pin plastic dual in-line package.

The elements are mounted on one leadframe providing a fixed distance between input and output for highest safety requirements.

VDE STANDARDS

These couplers perform safety functions according to the following equipment standards:

- **DIN EN 60747-5-5**
Optocoupler for electrical safety requirements
- **IEC 60950/EN 60950**
Office machines (applied for reinforced isolation for mains voltage $\leq 400 V_{RMS}$)
- **VDE 0804**
Telecommunication apparatus and data processing
- **IEC 60065**
Safety for mains-operated electronic and related household apparatus

FEATURES

- Isolation materials according to UL94-VO
- Pollution degree 2 (DIN/VDE 0110/resp. IEC 60664)
- Climatic classification 55/100/21 (IEC 60068 part 1)
- Special construction: therefore, extra low coupling capacity of typical 0.2 pF, high common mode rejection
- Low temperature coefficient of CTR
- CTR offered in 3 groups
- Rated isolation voltage (RMS includes DC) $V_{IOWM} = 600 V_{RMS}$ (848 V peak)
- Rated recurring peak voltage (repetitive) $V_{IORM} = 600 V_{RMS}$
- Rated impulse voltage (transient overvoltage) $V_{IOTM} = 6 kV_{peak}$
- Isolation test voltage (partial discharge test voltage) $V_{pd} = 1.6 kV$
- Creepage current resistance according to VDE 0303/ IEC 60112 comparative tracking index: **CTI** ≥ 275
- Thickness through insulation ≥ 0.75 mm
- Lead (Pb)-free component
- Component in accordance to RoHS 2002/95/EC and WEEE 2002/96/EC



RoHS
COMPLIANT

APPLICATIONS

- Switch-mode power supplies
- Line receiver
- Computer peripheral interface
- Microprocessor system interface
- Circuits for safe protective separation against electrical shock according to safety class II (reinforced isolation):
 - for appl. class I - IV at mains voltage ≤ 300 V
 - for appl. class I - III at mains voltage ≤ 600 V according to DIN EN 60747-5-5.

AGENCY APPROVALS

- UL1577, file no. E76222 system code A, double protection
- BSI: BS EN 41003, BS EN 60095 (BS 415), BS EN 60950 (BS 7002), certificate number 7081 and 7402
- DIN EN 60747-5-5
- FIMKO (SETI): EN 60950, certificate no. 12399

**ORDER INFORMATION**

PART	REMARKS
CNY75A	CTR 63 to 125 %, DIP-6
CNY75B	CTR 100 to 200 %, DIP-6
CNY75C	CTR 160 to 320 %, DIP-6
CNY75GA	CTR 63 to 125 %, DIP-6
CNY75GB	CTR 100 to 200 %, DIP-6
CNY75GC	CTR 160 to 320 %, DIP-6

Note

G = leadform 10.16 mm; G is not marked on the body.

ABSOLUTE MAXIMUM RATINGS (1)

PARAMETER	TEST CONDITION	SYMBOL	VALUE	UNIT
INPUT				
Reverse voltage		V_R	5.0	V
Forward current		I_F	60	mA
Forward surge current	$t_p \leq 10 \mu\text{s}$	I_{FSM}	3.0	A
Power dissipation		P_{diss}	100	mW
Junction temperature		T_j	125	°C
OUTPUT				
Collector base voltage		V_{CBO}	90	V
Collector emitter voltage		V_{CEO}	90	V
Emitter collector voltage		V_{ECO}	7.0	V
Collector current		I_C	50	mA
Collector peak current	$t_p/T = 0.5, t_p \leq 10 \text{ ms}$	I_{CM}	100	mA
Power dissipation		P_{diss}	150	mW
Junction temperature		T_j	125	°C
COUPLER				
AC isolation test voltage (RMS)	$t = 1 \text{ min}$	V_{ISO}	3750	V_{RMS}
Total power dissipation		P_{tot}	250	mW
Ambient temperature range		T_{amb}	- 55 to + 100	°C
Storage temperature range		T_{stg}	- 55 to + 125	°C
Soldering temperature (2)	2 mm from case, $t \leq 10 \text{ s}$	T_{sld}	260	°C

Note(1) $T_{amb} = 25 \text{ °C}$, unless otherwise specified.

Stresses in excess of the absolute maximum ratings can cause permanent damage to the device. Functional operation of the device is not implied at these or any other conditions in excess of those given in the operational sections of this document. Exposure to absolute maximum ratings for extended periods of the time can adversely affect reliability.

(2) Refer to wave profile for soldering conditions for through hole devices.

ELECTRICAL CHARACTERISTICS

PARAMETER	TEST CONDITION	PART	SYMBOL	MIN.	TYP.	MAX.	UNIT
INPUT							
Forward voltage	$I_F = 50 \text{ mA}$		V_F		1.25	1.6	V
Reverse current	$V_R = 6 \text{ V}$		I_R			10	μA
Junction capacitance	$V_R = 0 \text{ V}, f = 1 \text{ MHz}$		C_j		50		pF

ELECTRICAL CHARACTERISTICS							
PARAMETER	TEST CONDITION	PART	SYMBOL	MIN.	TYP.	MAX.	UNIT
OUTPUT							
Collector base voltage	$I_C = 100 \mu\text{A}$		V_{CBO}	90			V
Collector emitter voltage	$I_C = 1 \text{ mA}$		V_{CEO}	90			V
Emitter collector voltage	$I_E = 100 \mu\text{A}$		V_{ECO}	7			V
Collector emitter leakage current	$V_{CE} = 20 \text{ V}, I_F = 0 \text{ A}$		I_{CEO}			150	nA
COUPLER							
Collector emitter saturation voltage	$I_F = 10 \text{ mA}, I_C = 1 \text{ mA}$		V_{CEsat}			0.3	V
Cut-off frequency	$V_{CE} = 5 \text{ V}, I_F = 10 \text{ mA}, R_L = 100 \Omega$		f_c		110		kHz
Coupling capacitance	$f = 1 \text{ MHz}$		C_k		0.3		pF

Note

$T_{amb} = 25 \text{ }^\circ\text{C}$, unless otherwise specified.

Minimum and maximum values were tested requirements. Typical values are characteristics of the device and are the result of engineering evaluations. Typical values are for information only and are not part of the testing requirements.

CURRENT TRANSFER RATIO							
PARAMETER	TEST CONDITION	PART	SYMBOL	MIN.	TYP.	MAX.	UNIT
I_C/I_F	$V_{CE} = 5 \text{ V}, I_F = 1 \text{ mA}$	CNY75GA	CTR	15			%
		CNY75GB	CTR	30			%
		CNY75GC	CTR	60			%
	$V_{CE} = 5 \text{ V}, I_F = 10 \text{ mA}$	CNY75GA	CTR	63		125	%
		CNY75GB	CTR	100		200	%
		CNY75GC	CTR	160		320	%

SWITCHING CHARACTERISTICS							
PARAMETER	TEST CONDITION	PART	SYMBOL	MIN	TYP.	MAX	UNIT
Current time	$V_{CC} = 5 \text{ V}, R_L = 100 \Omega$ (see figure 3)	CNY75GA	I_F		10		mA
		CNY75GB	I_F		10		mA
		CNY75GC	I_F		10		mA
Delay time	$V_{CC} = 5 \text{ V}, R_L = 100 \Omega$ (see figure 3)	CNY75GA	t_d		2		μs
		CNY75GB	t_d		2.5		μs
		CNY75GC	t_d		2.8		μs
Rise time	$V_{CC} = 5 \text{ V}, R_L = 100 \Omega$ (see figure 3)	CNY75GA	t_r		2.5		μs
		CNY75GB	t_r		3		μs
		CNY75GC	t_r		4.2		μs
Fall time	$V_{CC} = 5 \text{ V}, R_L = 100 \Omega$ (see figure 3)	CNY75GA	t_f		2.7		μs
		CNY75GB	t_f		3.7		μs
		CNY75GC	t_f		4.7		μs
Storage time	$V_{CC} = 5 \text{ V}, R_L = 100 \Omega$ (see figure 3)	CNY75GA	t_s		0.3		μs
		CNY75GB	t_s		0.3		μs
		CNY75GC	t_s		0.3		μs
Turn-on time	$V_{CC} = 5 \text{ V}, R_L = 100 \Omega$ (see figure 3)	CNY75GA	t_{on}		4.5		μs
		CNY75GB	t_{on}		5.5		μs
		CNY75GC	t_{on}		7		μs
Turn-off time	$V_{CC} = 5 \text{ V}, R_L = 100 \Omega$ (see figure 3)	CNY75GA	t_{off}		3		μs
		CNY75GB	t_{off}		4		μs
		CNY75GC	t_{off}		5		μs



SWITCHING CHARACTERISTICS							
PARAMETER	TEST CONDITION	PART	SYMBOL	MIN	TYP.	MAX	UNIT
Turn-on time	$V_{CC} = 5\text{ V}$, $R_L = 1\text{ k}\Omega$ (see figure 4)	CNY75GA	t_{on}		10		μs
		CNY75GB	t_{on}		16.5		μs
		CNY75GC	t_{on}		11		μs
Turn-off time	$V_{CC} = 5\text{ V}$, $R_L = 1\text{ k}\Omega$ (see figure 4)	CNY75GA	t_{off}		25		μs
		CNY75GB	t_{off}		20		μs
		CNY75GC	t_{off}		37.5		μs

MAXIMUM SAFETY RATINGS						
PARAMETER	TEST CONDITION	SYMBOL	MIN.	TYP.	MAX.	UNIT
INPUT						
Forward current		I_F			130	mA
OUTPUT						
Power dissipation		P_{diss}			265	mW
COUPLER						
Rated impulse voltage		V_{IOTM}			6	kV
Safety temperature		T_{si}			150	$^{\circ}\text{C}$

Note

According to DIN EN 60747-5-5 (see figure 1). This optocoupler is suitable for safe electrical isolation only within the safety ratings. Compliance with the safety ratings shall be ensured by means of suitable protective circuits.

INSULATION RATED PARAMETERS						
PARAMETER	TEST CONDITION	SYMBOL	MIN.	TYP.	MAX.	UNIT
Partial discharge test voltage - routine test	100 %, $t_{test} = 1\text{ s}$	V_{pd}	1.6			kV
Partial discharge test voltage - lot test (sample test)	$t_{Tr} = 60\text{ s}$, $t_{test} = 10\text{ s}$, (see figure 2)	V_{IOTM}	6.0			kV
		V_{pd}	1.3			kV
Insulation resistance	$V_{IO} = 500\text{ V}$	R_{IO}	10^{12}			Ω
	$V_{IO} = 500\text{ V}$, $T_{amb} \leq 100\text{ }^{\circ}\text{C}$	R_{IO}	10^{11}			Ω
	$V_{IO} = 500\text{ V}$, $T_{amb} \leq 150\text{ }^{\circ}\text{C}$ (construction test only)	R_{IO}	10^9			Ω

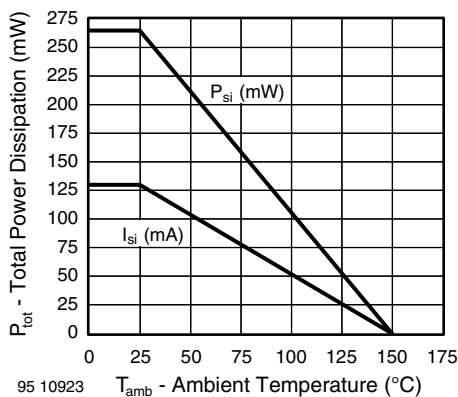

Fig. 1 - Derating Diagram

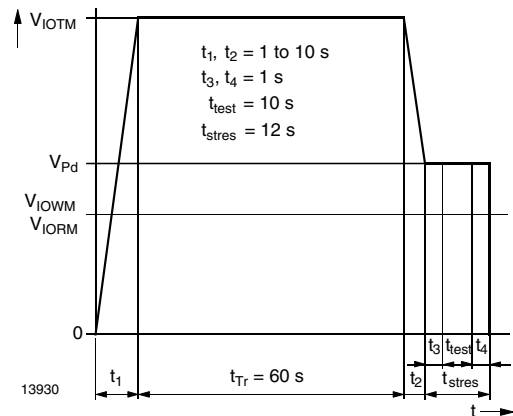

Fig. 2 - Test Pulse Diagram for Sample Test according to DIN EN 60747-5-5/DIN EN 60747-; IEC60747

TYPICAL CHARACTERISTICS

$T_{amb} = 25\text{ }^{\circ}\text{C}$, unless otherwise specified

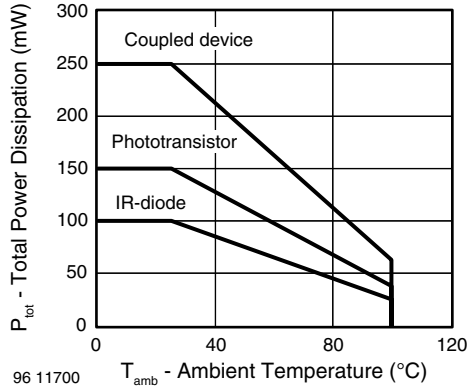

Fig. 3 - Total Power Dissipation vs. Ambient Temperature

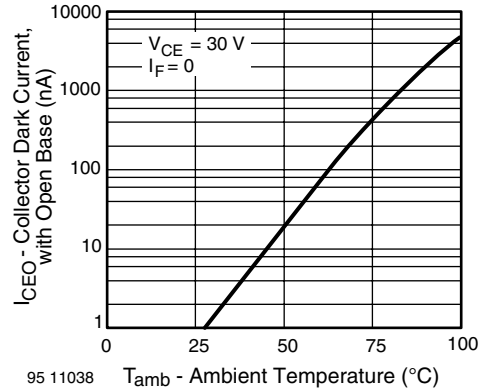

Fig. 6 - Collector Dark Current vs. Ambient Temperature

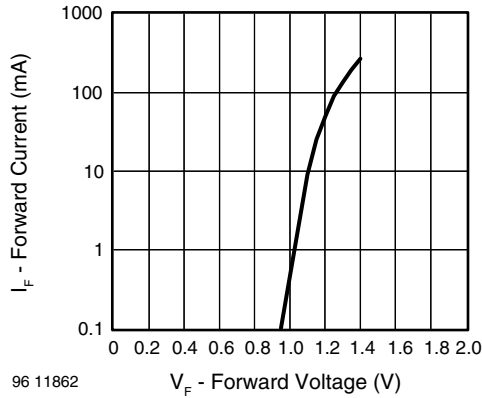

Fig. 4 - Forward Current vs. Forward Voltage

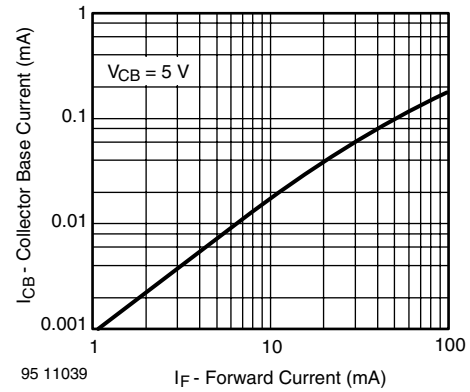

Fig. 7 - Collector Base Current vs. Forward Current

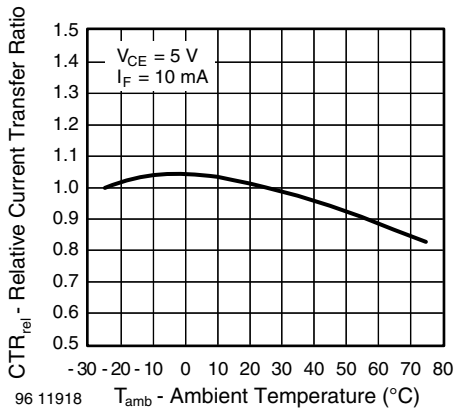

Fig. 5 - Relative Current Transfer Ratio vs. Ambient Temperature

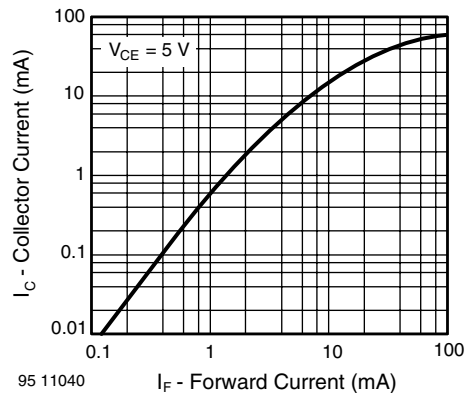

Fig. 8 - Collector Current vs. Forward Current

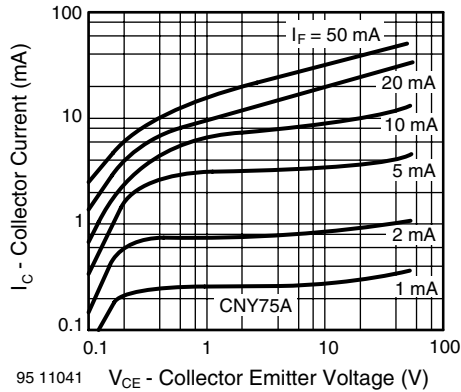

Fig. 9 - Collector Current vs. Collector Emitter Voltage

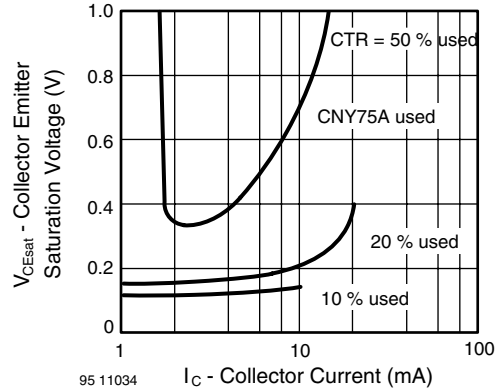

Fig. 12 - Collector Emitter Saturation Voltage vs. Collector Current

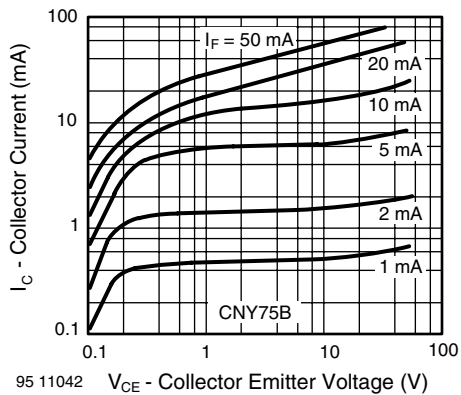

Fig. 10 - Collector Current vs. Collector Emitter Voltage

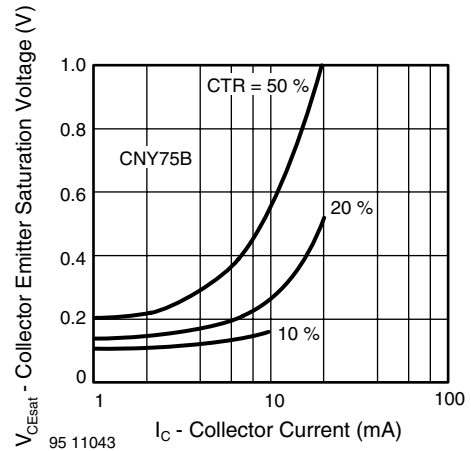

Fig. 13 - Collector Emitter Saturation Voltage vs. Collector Current

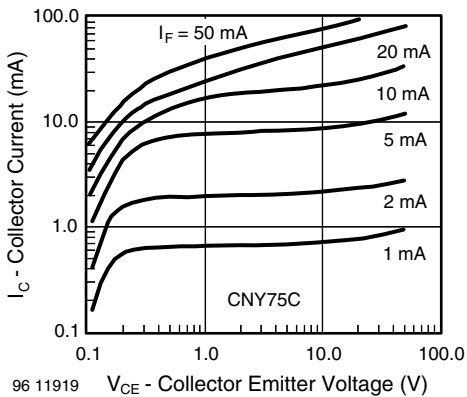

Fig. 11 - Collector Current vs. Collector Emitter Voltage

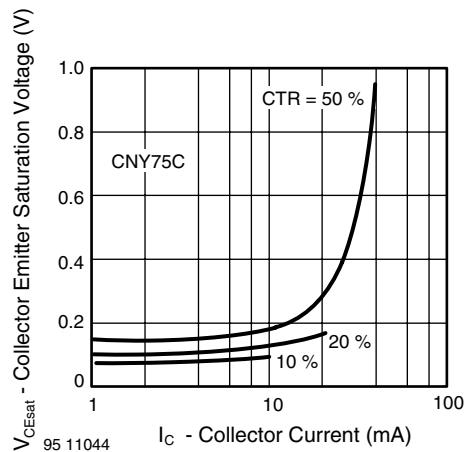

Fig. 14 - Collector Emitter Saturation Voltage vs. Collector Current

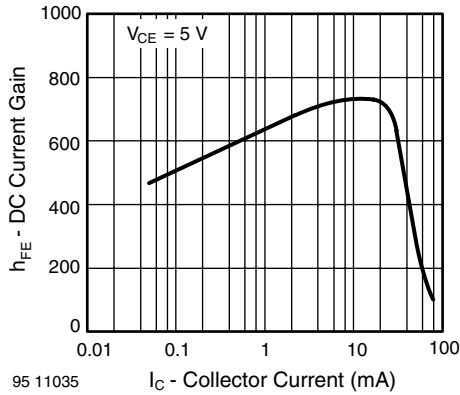

Fig. 15 - DC Current Gain vs. Collector Current

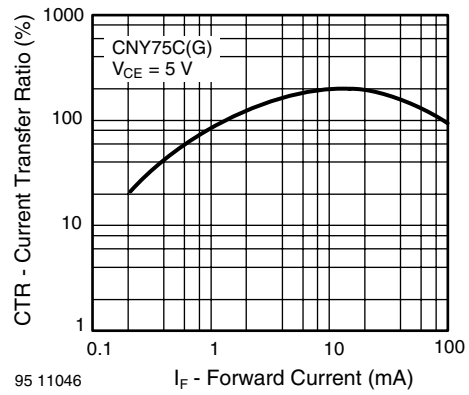

Fig. 18 - Current Transfer Ratio vs. Forward Current

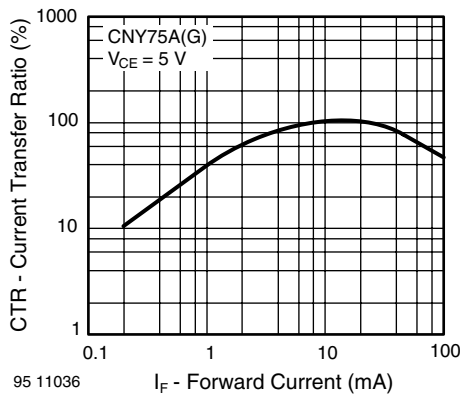

Fig. 16 - Current Transfer Ratio vs. Forward Current

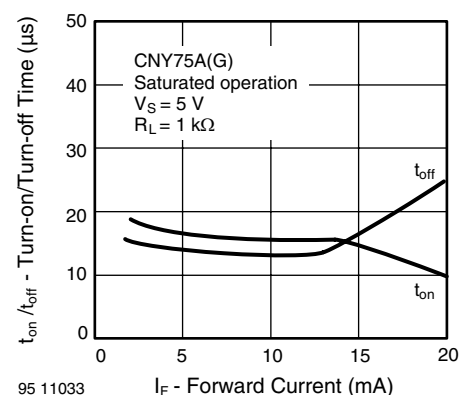

Fig. 19 - Turn-on/off Time vs. Forward Current

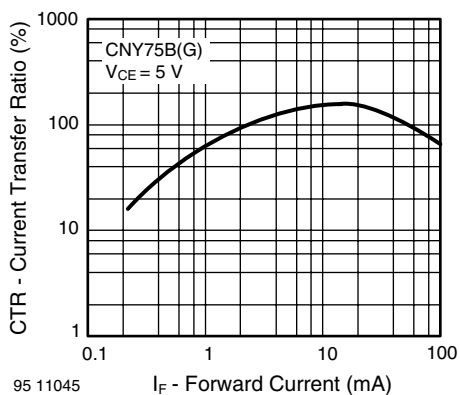

Fig. 17 - Current Transfer Ratio vs. Forward Current

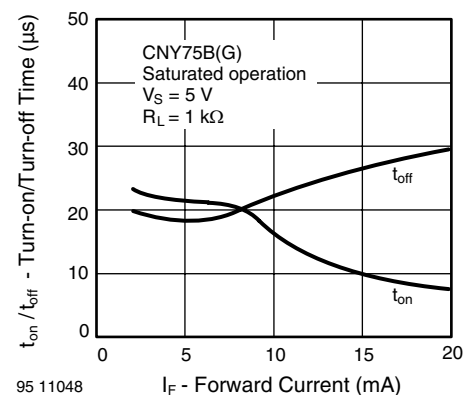

Fig. 20 - Turn-on/off Time vs. Forward Current

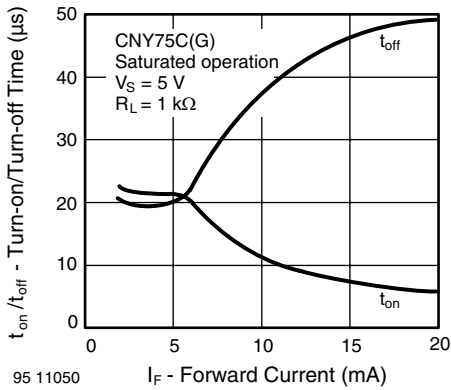

Fig. 21 - Turn-on/off Time vs. Forward Current

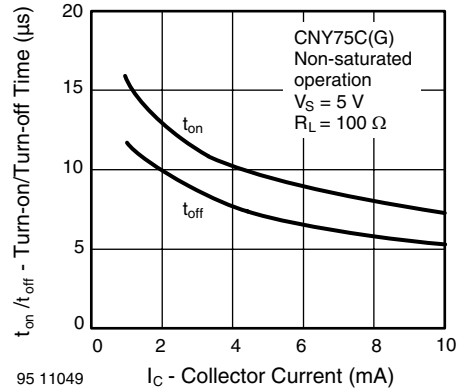

Fig. 24 - Turn-on/off Time vs. Collector Current

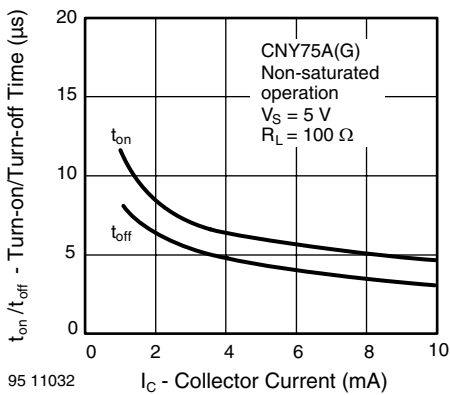

Fig. 22 - Turn-on/off Time vs. Collector Current

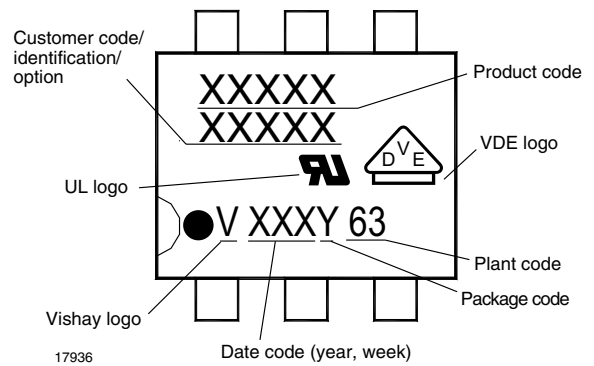

Fig. 25 - Marking Example

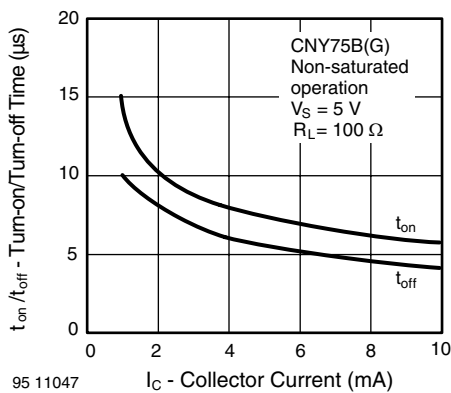

Fig. 23 - Turn-on/off Time vs. Collector Current

CNY75A/B/C/GA/GB/GC



Vishay Semiconductors Optocoupler, Phototransistor Output,
with Base Connection

PACKAGE DIMENSIONS in millimeters

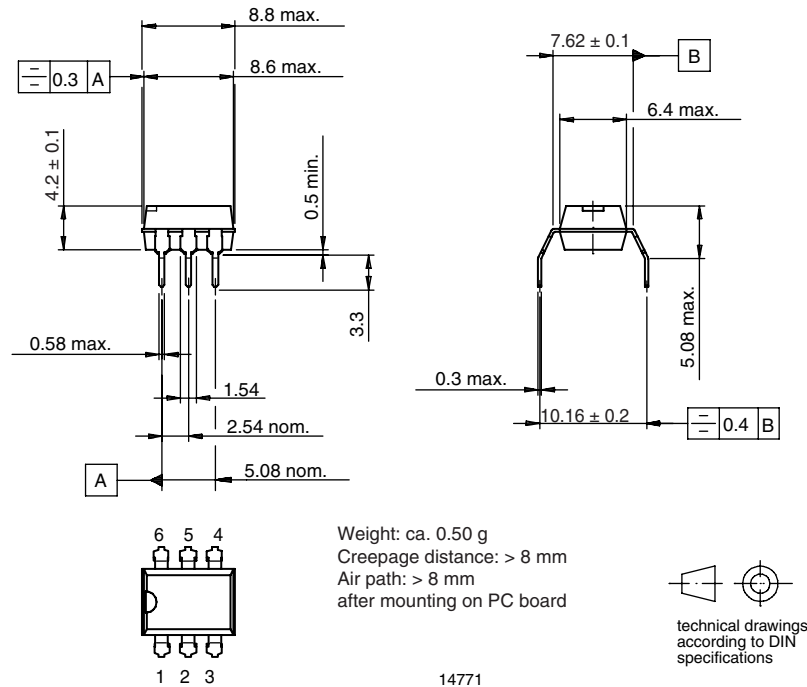
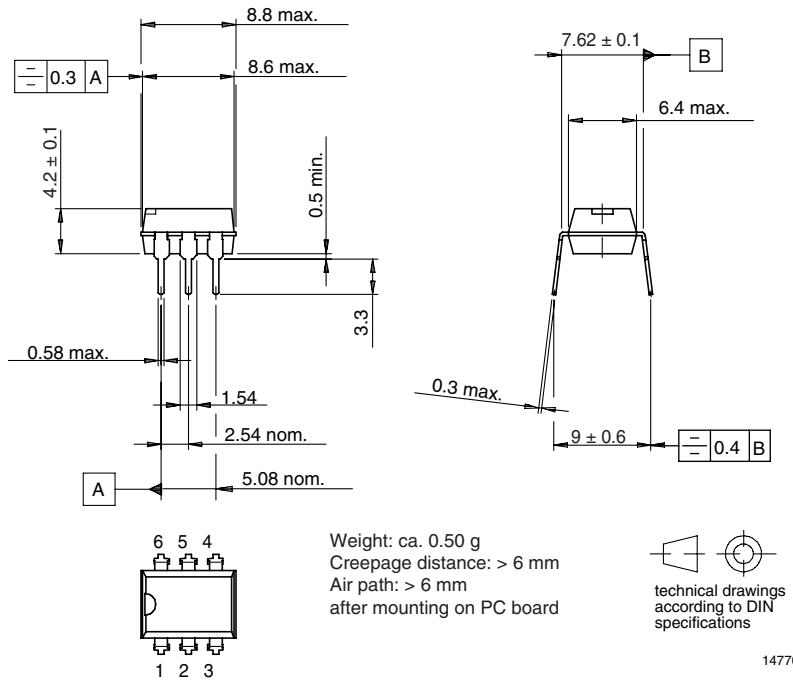

**OZONE DEPLETING SUBSTANCES POLICY STATEMENT**

It is the policy of Vishay Semiconductor GmbH to

1. Meet all present and future national and international statutory requirements.
2. Regularly and continuously improve the performance of our products, processes, distribution and operating systems with respect to their impact on the health and safety of our employees and the public, as well as their impact on the environment.

It is particular concern to control or eliminate releases of those substances into the atmosphere which are known as ozone depleting substances (ODSs).

The Montreal Protocol (1987) and its London Amendments (1990) intend to severely restrict the use of ODSs and forbid their use within the next ten years. Various national and international initiatives are pressing for an earlier ban on these substances.

Vishay Semiconductor GmbH has been able to use its policy of continuous improvements to eliminate the use of ODSs listed in the following documents.

1. Annex A, B and list of transitional substances of the Montreal Protocol and the London Amendments respectively.
2. Class I and II ozone depleting substances in the Clean Air Act Amendments of 1990 by the Environmental Protection Agency (EPA) in the USA
3. Council Decision 88/540/EEC and 91/690/EEC Annex A, B and C (transitional substances) respectively.

Vishay Semiconductor GmbH can certify that our semiconductors are not manufactured with ozone depleting substances and do not contain such substances.

We reserve the right to make changes to improve technical design
and may do so without further notice.

Parameters can vary in different applications. All operating parameters must be validated for each customer application by the customer. Should the buyer use Vishay Semiconductors products for any unintended or unauthorized application, the buyer shall indemnify Vishay Semiconductors against all claims, costs, damages, and expenses, arising out of, directly or indirectly, any claim of personal damage, injury or death associated with such unintended or unauthorized use.

Vishay Semiconductor GmbH, P.O.B. 3535, D-74025 Heilbronn, Germany



Disclaimer

All product specifications and data are subject to change without notice.

Vishay Intertechnology, Inc., its affiliates, agents, and employees, and all persons acting on its or their behalf (collectively, "Vishay"), disclaim any and all liability for any errors, inaccuracies or incompleteness contained herein or in any other disclosure relating to any product.

Vishay disclaims any and all liability arising out of the use or application of any product described herein or of any information provided herein to the maximum extent permitted by law. The product specifications do not expand or otherwise modify Vishay's terms and conditions of purchase, including but not limited to the warranty expressed therein, which apply to these products.

No license, express or implied, by estoppel or otherwise, to any intellectual property rights is granted by this document or by any conduct of Vishay.

The products shown herein are not designed for use in medical, life-saving, or life-sustaining applications unless otherwise expressly indicated. Customers using or selling Vishay products not expressly indicated for use in such applications do so entirely at their own risk and agree to fully indemnify Vishay for any damages arising or resulting from such use or sale. Please contact authorized Vishay personnel to obtain written terms and conditions regarding products designed for such applications.

Product names and markings noted herein may be trademarks of their respective owners.

Компания «Океан Электроники» предлагает заключение долгосрочных отношений при поставках импортных электронных компонентов на взаимовыгодных условиях!

Наши преимущества:

- Поставка оригинальных импортных электронных компонентов напрямую с производств Америки, Европы и Азии, а так же с крупнейших складов мира;
- Широкая линейка поставок активных и пассивных импортных электронных компонентов (более 30 млн. наименований);
- Поставка сложных, дефицитных, либо снятых с производства позиций;
- Оперативные сроки поставки под заказ (от 5 рабочих дней);
- Экспресс доставка в любую точку России;
- Помощь Конструкторского Отдела и консультации квалифицированных инженеров;
- Техническая поддержка проекта, помощь в подборе аналогов, поставка прототипов;
- Поставка электронных компонентов под контролем ВП;
- Система менеджмента качества сертифицирована по Международному стандарту ISO 9001;
- При необходимости вся продукция военного и аэрокосмического назначения проходит испытания и сертификацию в лаборатории (по согласованию с заказчиком);
- Поставка специализированных компонентов военного и аэрокосмического уровня качества (Xilinx, Altera, Analog Devices, Intersil, Interpoint, Microsemi, Actel, Aeroflex, Peregrine, VPT, Syfer, Eurofarad, Texas Instruments, MS Kennedy, Miteq, Cobham, E2V, MA-COM, Hittite, Mini-Circuits, General Dynamics и др.);

Компания «Океан Электроники» является официальным дистрибьютором и эксклюзивным представителем в России одного из крупнейших производителей разъемов военного и аэрокосмического назначения «JONHON», а так же официальным дистрибьютором и эксклюзивным представителем в России производителя высокотехнологичных и надежных решений для передачи СВЧ сигналов «FORSTAR».



JONHON

«JONHON» (основан в 1970 г.)

Разъемы специального, военного и аэрокосмического назначения:

(Применяются в военной, авиационной, аэрокосмической, морской, железнодорожной, горно- и нефтедобывающей отраслях промышленности)

«FORSTAR» (основан в 1998 г.)

ВЧ соединители, коаксиальные кабели, кабельные сборки и микроволновые компоненты:

(Применяются в телекоммуникациях гражданского и специального назначения, в средствах связи, РЛС, а так же военной, авиационной и аэрокосмической отраслях промышленности).



Телефон: 8 (812) 309-75-97 (многоканальный)

Факс: 8 (812) 320-03-32

Электронная почта: ocean@oceanchips.ru

Web: <http://oceanchips.ru/>

Адрес: 198099, г. Санкт-Петербург, ул. Калинина, д. 2, корп. 4, лит. А