

High Precision Foil Resistor with TCR of $\pm 2.0 \text{ ppm}/^\circ\text{C}$, Tolerance of $\pm 0.005 \%$ and Load Life Stability of $\pm 0.005 \%$



INTRODUCTION

Bulk Metal® Foil (BMF) technology outperforms all other resistor technologies available today for applications that require high precision and high stability.

This technology has been pioneered and developed by Vishay Foil Resistors (VFR), and products based on this technology are the most suitable for a wide range of applications. BMF technology allows the production of customer-oriented products, designed to satisfy specific challenging technical requirements.

The S series of BMF resistors offers low TCR, excellent load life stability, tight tolerance, fast response time, low current noise, low thermal EMF and low voltage coefficient, all in one resistor.

The S series is virtually insensitive to destabilizing factors. The resistor element is a solid alloy that displays the desirable bulk properties of its parent material, thus it is inherently stable and noise free. The standard design of these resistors provides a unique combination of characteristics found in no other single resistor.

VFR's application engineering department is available to advise and to make recommendations. For non-standard technical requirements and special applications, please contact foil@vishaypg.com.

TABLE 1 - RESISTANCE VERSUS TCR
(- 55 °C to + 125 °C, + 25 °C ref.)

RESISTOR ^{(1) (2)}	RESISTANCE VALUE (Ω)	TYPICAL TCR AND MAX SPREAD ($\text{ppm}/^\circ\text{C}$)
S10X(C) / (D)	80 to < 1M	$\pm 2 \pm 2.5$
S10X(K)	80 to < 600K	$\pm 1 \pm 2.5$
S10X(C) / (D)	50 to < 80	$\pm 2 \pm 3.5$
S10X(K)		$\pm 1 \pm 3.5$
S10X(C) / (D)	0.5 to < 50	$\pm 2 \pm 4.5$
S10X(K)		$\pm 1 \pm 4.5$

(1) X refers to S Series model number - see Table 2

(2) (C) and (D) refer to C Foil Alloy Types; (K) refers to the K Foil Alloy type - see Figure 1

* Pb containing terminations are not RoHS compliant, exemptions may apply

FEATURES

- Temperature coefficient of resistance (TCR):
 - 55 °C to + 125 °C, 25 °C ref.
 - S10XC / D series: $\pm 2 \text{ ppm}/^\circ\text{C}$ typical (see table 1)
 - S10XK series: $\pm 1 \text{ ppm}/^\circ\text{C}$ typical (see table 1)
- Power rating: to 1 W at + 125 °C
- Resistance tolerance: to $\pm 0.005 \%$ (50 ppm)
- Load life stability: $\pm 0.005 \%$ at 70 °C, 2000 h at rated power
- Resistance range: 0.5 Ω to 1 M Ω (for higher or lower values, please contact Application Engineering)
- Vishay Foil resistors are not restricted to standard values; specific "as required" values can be supplied at no extra cost or delivery (e.g. 1K2345 vs. 1K)
- Electrostatic discharge (ESD) at least to 25 kV
 - Non inductive, non capacitive design
 - Rise time: 1 ns effectively no ringing
 - Current noise: 0.010 $\mu\text{V}_{\text{RMS}}/\text{V}$ of applied voltage (< - 40 dB)
 - Thermal EMF: 0.05 $\mu\text{V}/^\circ\text{C}$
 - Voltage coefficient: < 0.1 ppm/V
 - Low inductance: < 0.08 μH
 - Non hot-spot design
 - Terminal finishes available: lead (Pb)-free, tin/lead alloy
- Matched sets are available on request (TCR tracking: to 0.5 ppm/ $^\circ\text{C}$)
- Prototype quantities available in just 5 working days or sooner. For more information, please contact foil@vishaypg.com
- For better TCR performances please review the datasheets for the **Z Series** and **Z203**



RoHS*
COMPLIANT

FIGURE 1 - TYPICAL RESISTANCE CHANGE VERSUS TEMPERATURE CURVES AND CHORD SLOPES (TCR) OF TWO ALLOY TYPES IN MILITARY RANGE



FIGURE 2 - STANDARD IMPRINTING AND DIMENSIONS



Note

- Standoffs provided to allow proper flushing of flux, debris, and contaminants from under resistor after all solder operations.
- The standoffs shall be so located as to give a lead clearance of 0.010" minimum between the resistor body and the printed circuit board when the standoffs are seated on the printed circuit board.

TABLE 2 - MODEL SELECTION

MODEL NUMBER	RESISTANCE RANGE (Ω)	MAXIMUM WORKING VOLTAGE	AMBIENT POWER RATING		AVERAGE WEIGHT IN GRAMS	DIMENSIONS			TIGHTEST TOLERANCE VS. LOWEST RESISTANCE VALUE
			at +70 °C	at +125 °C		INCHES	mm	F (¹) (INCHES)	
S102C (S102J) (²)	1 to 150K	300	0.6 W	0.3 W	0.6	W: 0.105 ± 0.010	2.67 ± 0.25		0.005 %/50 Ω 0.01 %/25 Ω 0.02 %/12 Ω 0.05 %/5 Ω 0.1 %/2 Ω 0.50 %/1 Ω 1 %/0.5 Ω
S102K (S102L) (²)	1 to 100K		up to 100K	0.4 W		0.2 W	L: 0.300 ± 0.010		
S104D (S104F) (¹)	1 to 500K	350	1.0 W	0.5 W	1.4	H: 0.326 ± 0.010	8.28 ± 0.25	(0.138)	
S104K	1 to 300K		0.6 W	0.3 W		ST: 0.010 min.	0.254 min.	(0.565)	
S105D (S105F) (¹)	1 to 750K	350	1.5 W	0.75 W	1.9	SW: 0.040 ± 0.005	1.02 ± 0.13	(0.413)	
S105K	1 to 500K		0.8 W	0.4 W		LL: 1.000 ± 0.125	25.4 ± 3.18	(0.890)	
S106D	0.5 to 1M	500	2.0 W	1.0 W	4.0	LS: 0.150 ± 0.005	3.81 ± 0.13	(0.7 ± 0.05)	
S106K	0.5 to 600K		1.0 W	0.5 W		W: 0.160 max.	4.06 max.		
			up to 400K	0.6 W	0.3 W	L: 0.575 max.	14.61 max.		
			over 400K	over 200K	over 300K	H: 0.413 max.	10.49 max.		
						ST: 0.035 ± 0.005	0.889 ± 0.13		
						SW: 0.050 ± 0.005	1.27 ± 0.13		
						LL: 1.000 ± 0.125	25.4 ± 3.18		
						LS: 0.400 ± 0.020	10.16 ± 0.51		
						W: 0.260 max.	6.60 max.		
						L: 1.200 max.	30.48 max.		
						H: 0.413 max.	10.49 max.		
						ST: 0.035 ± 0.005	0.889 ± 0.13		
						SW: 0.050 ± 0.005	1.27 ± 0.13		
						LL: 1.000 ± 0.125	25.4 ± 3.18		
						LS: 0.900 ± 0.020	22.86 ± 0.51		

Notes

- S104F and S105F have different package dimensions (see the third column of dimensions). All other specifications are the same.
- 0.200" (5.08 mm) lead spacing available - specify S102J for S102C, and S102L for S102K.

FIGURE 3 - POWER DERATING CURVE



FIGURE 4 - TRIMMING TO VALUES
(conceptual illustration)

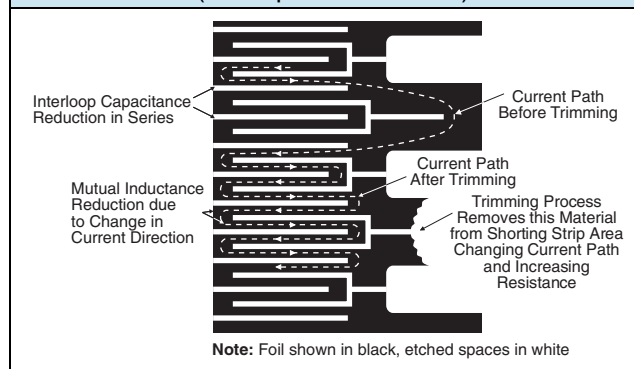

TABLE 3 - ENVIRONMENTAL PERFORMANCE COMPARISON

	MIL-PRF-55182 CHAR J	S-SERIES MAXIMUM ΔR	S-SERIES TYPICAL ΔR
Test Group I			
Thermal shock, 5 x (- 65 °C to + 150 °C)	± 0.2 %	± 0.01 % (100 ppm)	± 0.002 % (20 ppm)
Short time overload, 6.25 x rated power	± 0.2 %	± 0.01 % (100 ppm)	± 0.003 % (30 ppm)
Test Group II			
Resistance temperature characteristics ⁽¹⁾	± 25 ppm/°C	± 6.5 ppm/°C	± 2.0 ppm/°C
Low temperature storage (24 h at - 65 °C)	± 0.15 %	± 0.01 % (100 ppm)	± 0.002 % (20 ppm)
Low temperature operation (45 min, rated power at - 65 °C)	± 0.15 %	± 0.01 % (100 ppm)	± 0.002 % (20 ppm)
Terminal strength	± 0.2 %	± 0.01 % (100 ppm)	± 0.002 % (20 ppm)
Test Group III			
Dielectric Withstanding Voltage (DWV)	± 0.15 %	± 0.01 % (100 ppm)	± 0.002 % (20 ppm)
Resistance to solder heat	± 0.1 %	± 0.01 % (100 ppm)	± 0.005 % (50 ppm)
Moisture resistance	± 0.4 %	± 0.05 % (500 ppm)	± 0.01 % (100 ppm)
Test Group IV			
Shock	± 0.2 %	± 0.01 % (100 ppm)	± 0.002 % (20 ppm)
Vibration	± 0.2 %	± 0.01 % (100 ppm)	± 0.002 % (20 ppm)
Test Group V			
Life test at 0.3 W/+ 125 °C			
2000 h	± 0.5 %	± 0.015 % (150 ppm)	± 0.01 % (100 ppm)
10 000 h	± 2.0 %	± 0.05 % (500 ppm)	± 0.03 % (300 ppm)
Test Group Va			
Life test at 0.6 W (2 x rated power)/+ 70 °C, 2000 h	± 0.5 %	± 0.015 % (150 ppm)	± 0.01 % (100 ppm)
Test Group VI			
High temperature exposure (2000 h at + 175 °C)	± 2.0 %	± 0.1 % (1000 ppm)	± 0.05 % (500 ppm)
Test Group VII			
Voltage coefficient	5 ppm/V	< 0.1 ppm/V	< 0.1 ppm/V

⁽¹⁾ See Table 1.

FIGURE 5 - LONG-TERM STABILITY OVER 29 YEARS (0.1W AT 70°C, 50 SAMPLES S102C, 10KΩ)



STANDARD OPERATIONS AND TEST CONDITIONS

A. Standard Test Operations:

By 100 % Inspection

- Short-time overload (6.25 x rated power for 5 s)
- Resistance - tolerance check
- Visual and mechanical

By Sample Inspection

- TCR
- Environmental tests per table 3 on a quarterly basis to establish performance by similarity

B. Standard Test Conditions:

- Lead test point: 0.5" (12.7 mm) from resistor body
- Temperature: + 23 °C ± 2 °C
- Relative humidity: per MIL-STD-202

IMPROVED PERFORMANCE TESTING (IPT)

The preceding information is based on product directly off the production line. Improved performance (meaning increased time stability with load and other stresses) is available through factory conducted "Improved Performance Testing". The test routine is usually tailored to the user's stability objectives and IPT-processed resistors can exhibit improved load-life stability levels of less than 50 ppm.

Various screen test routines are available and all anticipated stresses must be taken into account before settling on one specific test routine. VFR's application engineering department is prepared to discuss and recommend appropriate routines given the full spectrum of anticipated stresses and stability requirements.

TABLE 4 - "S" SERIES SPECIFICATIONS

Stability (1)		
Load life at 2000 h	± 0.015 % (150 ppm)	Maximum ΔR at 0.3 W/+ 125 °C
	± 0.005 % (50 ppm)	Maximum ΔR at 0.1 W/+ 70 °C
Load life at 10 000 h	± 0.05 % (500 ppm)	Maximum ΔR at 0.3 W/+ 125 °C
	± 0.01 % (100 ppm)	Maximum ΔR at 0.05 W/+ 125 °C
Current Noise	0.010 μV	(RMS)/V of applied voltage (- 40 dB)
High Frequency Operation		
Rise time	1.0 ns at 1 kΩ	
Inductance (L) (2)	0.1 μH maximum; 0.08 μH typical	
Capacitance (C)	1.0 pF maximum; 0.5 pF typical	
Voltage Coefficient	< 0.1 ppm/V (3)	
Thermal Electromotive Force (EMF) (4)	0.1 μV/°C Maximum; 0.05 μV/°C typical	
	1 μV/W	(Model S102C)

Notes

- (1) Load life ΔR maximum can be reduced by 80 %, please contact applications engineering department.
- (2) Inductance (L) due mainly to the leads.
- (3) The resolution limit of existing test equipment (within the measurement capability of the equipment, or "essentially zero".)
- (4) μV/°C relates to EMF due to lead temperature difference and μV/watt due to power applied to the resistor.

TABLE 5 - GLOBAL PART NUMBER INFORMATION (1)

NEW GLOBAL PART NUMBER: Y000780K5000V9L (preferred part number format)



FOR EXAMPLE: ABOVE GLOBAL ORDER Y0007 80K5000 V 9 L:

TYPE: S102C

VALUE: 80.5 kΩ

ABSOLUTE TOLERANCE: ± 0.005 %

TERMINATION: lead (Pb)-free

PACKAGING: bulk pack

HISTORICAL PART NUMBER: S102C T 80K500 V B (will continue to be used)



Note

(1) For non-standard requests, please contact application engineering.

Disclaimer

ALL PRODUCTS, PRODUCT SPECIFICATIONS AND DATA ARE SUBJECT TO CHANGE WITHOUT NOTICE.

Vishay Precision Group, Inc., its affiliates, agents, and employees, and all persons acting on its or their behalf (collectively, "Vishay Precision Group"), disclaim any and all liability for any errors, inaccuracies or incompleteness contained herein or in any other disclosure relating to any product.

The product specifications do not expand or otherwise modify Vishay Precision Group's terms and conditions of purchase, including but not limited to, the warranty expressed therein.

Vishay Precision Group makes no warranty, representation or guarantee other than as set forth in the terms and conditions of purchase. **To the maximum extent permitted by applicable law, Vishay Precision Group disclaims (i) any and all liability arising out of the application or use of any product, (ii) any and all liability, including without limitation special, consequential or incidental damages, and (iii) any and all implied warranties, including warranties of fitness for particular purpose, non-infringement and merchantability.**

Information provided in datasheets and/or specifications may vary from actual results in different applications and performance may vary over time. Statements regarding the suitability of products for certain types of applications are based on Vishay Precision Group's knowledge of typical requirements that are often placed on Vishay Precision Group products. It is the customer's responsibility to validate that a particular product with the properties described in the product specification is suitable for use in a particular application.

No license, express, implied, or otherwise, to any intellectual property rights is granted by this document, or by any conduct of Vishay Precision Group.

The products shown herein are not designed for use in life-saving or life-sustaining applications unless otherwise expressly indicated. Customers using or selling Vishay Precision Group products not expressly indicated for use in such applications do so entirely at their own risk and agree to fully indemnify Vishay Precision Group for any damages arising or resulting from such use or sale. Please contact authorized Vishay Precision Group personnel to obtain written terms and conditions regarding products designed for such applications.

Product names and markings noted herein may be trademarks of their respective owners.

Компания «Океан Электроники» предлагает заключение долгосрочных отношений при поставках импортных электронных компонентов на взаимовыгодных условиях!

Наши преимущества:

- Поставка оригинальных импортных электронных компонентов напрямую с производств Америки, Европы и Азии, а так же с крупнейших складов мира;
- Широкая линейка поставок активных и пассивных импортных электронных компонентов (более 30 млн. наименований);
- Поставка сложных, дефицитных, либо снятых с производства позиций;
- Оперативные сроки поставки под заказ (от 5 рабочих дней);
- Экспресс доставка в любую точку России;
- Помощь Конструкторского Отдела и консультации квалифицированных инженеров;
- Техническая поддержка проекта, помощь в подборе аналогов, поставка прототипов;
- Поставка электронных компонентов под контролем ВП;
- Система менеджмента качества сертифицирована по Международному стандарту ISO 9001;
- При необходимости вся продукция военного и аэрокосмического назначения проходит испытания и сертификацию в лаборатории (по согласованию с заказчиком);
- Поставка специализированных компонентов военного и аэрокосмического уровня качества (Xilinx, Altera, Analog Devices, Intersil, Interpoint, Microsemi, Actel, Aeroflex, Peregrine, VPT, Syfer, Eurofarad, Texas Instruments, MS Kennedy, Miteq, Cobham, E2V, MA-COM, Hittite, Mini-Circuits, General Dynamics и др.);

Компания «Океан Электроники» является официальным дистрибьютором и эксклюзивным представителем в России одного из крупнейших производителей разъемов военного и аэрокосмического назначения «JONHON», а так же официальным дистрибьютором и эксклюзивным представителем в России производителя высокотехнологичных и надежных решений для передачи СВЧ сигналов «FORSTAR».



JONHON

«JONHON» (основан в 1970 г.)

Разъемы специального, военного и аэрокосмического назначения:

(Применяются в военной, авиационной, аэрокосмической, морской, железнодорожной, горно- и нефтедобывающей отраслях промышленности)

«FORSTAR» (основан в 1998 г.)

ВЧ соединители, коаксиальные кабели, кабельные сборки и микроволновые компоненты:

(Применяются в телекоммуникациях гражданского и специального назначения, в средствах связи, РЛС, а так же военной, авиационной и аэрокосмической отраслях промышленности).



Телефон: 8 (812) 309-75-97 (многоканальный)

Факс: 8 (812) 320-03-32

Электронная почта: ocean@oceanchips.ru

Web: <http://oceanchips.ru/>

Адрес: 198099, г. Санкт-Петербург, ул. Калинина, д. 2, корп. 4, лит. А