

Decompensated Low Noise, High Speed Precision Op Amps

FEATURES

- 100% Tested Low Voltage Noise: $2.7\text{nV}/\sqrt{\text{Hz}}$ Typ, $4.2\text{nV}/\sqrt{\text{Hz}}$ Max
- Slew Rate: $11\text{V}/\mu\text{s}$ Typ
- Gain-Bandwidth Product: 65MHz Typ
- Offset Voltage, Prime Grade: $70\mu\text{V}$ Max
Low Grade: $100\mu\text{V}$ Max
- High Voltage Gain: 5 Million Min
- Supply Current Per Amplifier: 3.1mA Max
- Common Mode Rejection: 112dB Min
- Power Supply Rejection: 116dB Min
- Available in 8-Lead SOIC, 8-Lead DIP, 16-Lead SO and 14-Lead DIP Packages

APPLICATIONS

- Two and Three Op Amp Instrumentation Amplifiers
- Low Noise Signal Processing
- Active Filters
- Microvolt Accuracy Threshold Detection
- Strain Gauge Amplifiers
- Direct Coupled Audio Gain Stages
- Tape Head Preamplifiers
- Microphone Preamplifiers
- Accelerometer Amplifiers
- Infrared Detectors

DESCRIPTION

The LT[®]1126 dual and LT1127 quad are high performance, decompensated op amps that offer higher slew rate and bandwidth than the LT1124 dual and the LT1125 quad operational amplifiers. The enhanced AC performance is available without degrading DC specs of the LT1124/LT1125. Both LT1126/LT1127 are stable in a gain of 10 or more.

In the design, processing and testing of the device, particular attention has been paid to the optimization of the entire distribution of several key parameters. Slew rate, gain-bandwidth and 1kHz noise are 100% tested for each individual amplifier. Consequently, the specifications of even the lowest cost grades (the LT1126C and the LT1127C) have been enhanced.

Power consumption of the dual LT1126 is less than one half of two OP-37s. Low power and high performance in an 8-pin SO package makes the LT1126 a first choice for surface mounted systems and where board space is restricted.

LT, LTC and LT are registered trademarks of Linear Technology Corporation. All other trademarks are the property of their respective owners. Protected by U.S. Patents including 4775884, 4837496.

TYPICAL APPLICATION

Low Noise, Wide Bandwidth Instrumentation Amplifier

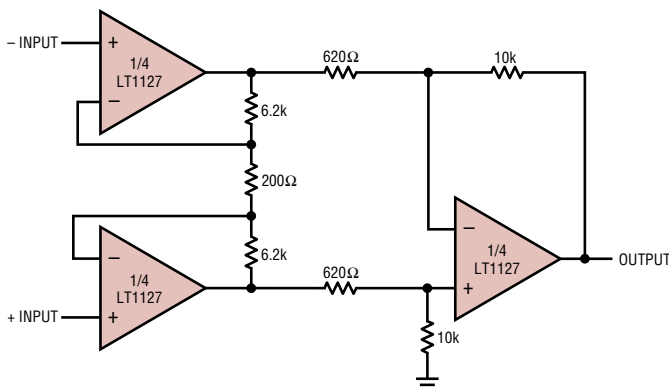

GAIN = 1000, BANDWIDTH = 480kHz
 INPUT REFERRED NOISE = $4.5\text{nV}/\sqrt{\text{Hz}}$ AT 1kHz , $6\mu\text{V}_{\text{RMS}}$ OVER BANDWIDTH

1126-7 TA01

Voltage Noise vs Frequency

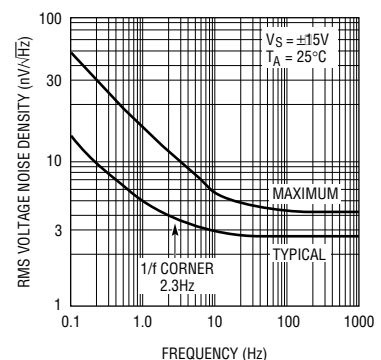

1126-7 TA01b

11267fa

ABSOLUTE MAXIMUM RATINGS (Note 1)

Supply Voltage $\pm 22V$
 Input Voltage Equal to Supply Voltage
 Output Short Circuit Duration Indefinite
 Differential Input Current (Note 5) $\pm 25mA$
 Lead Temperature (Soldering, 10 sec.) $300^{\circ}C$

Operating Temperature Range
 LT1126AM/LT1126M
 LT1127AM/LT1127M (**OBSELETE**) .. $-55^{\circ}C$ to $125^{\circ}C$
 LT1126AC/LT1126C
 LT1127AC/LT1127C $-40^{\circ}C$ to $85^{\circ}C$
 Storage Temperature Range
 All Grades $-65^{\circ}C$ to $150^{\circ}C$

PACKAGE/ORDER INFORMATION

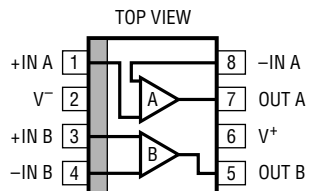
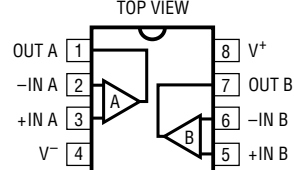
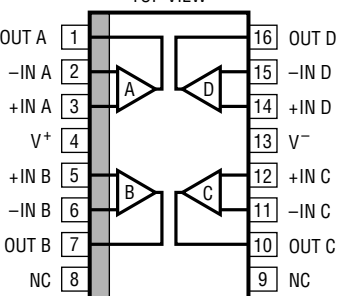
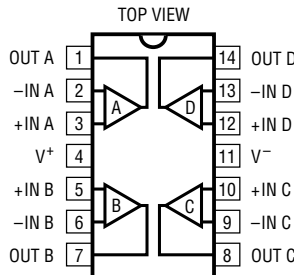
 <p>TOP VIEW</p> <p>+IN A 1 8 -IN A V⁻ 2 7 OUT A +IN B 3 6 V⁺ -IN B 4 5 OUT B</p> <p>S8 PACKAGE 8-LEAD PLASTIC SO $T_{JMAX} = 140^{\circ}C, \theta_{JA} = 190^{\circ}C/W$</p> <p>NOTE: THIS PIN CONFIGURATION DIFFERS FROM THE 8-PIN PDIP CONFIGURATION. INSTEAD, IT FOLLOWS THE INDUSTRY STANDARD LT1013DS8 SO PACKAGE PIN LOCATIONS</p>	<p>ORDER PART NUMBER</p> <p>LT1126CS8</p> <p>S8 PART MARKING</p> <p>1126</p>	 <p>TOP VIEW</p> <p>OUT A 1 8 V⁺ -IN A 2 7 OUT B +IN A 3 6 -IN B V⁻ 4 5 +IN B</p> <p>N8 PACKAGE 8-LEAD PDIP $T_{JMAX} = 140^{\circ}C, \theta_{JA} = 130^{\circ}C$</p> <p>J8 PACKAGE 8-LEAD CERAMIC DIP $T_{JMAX} = 160^{\circ}C, \theta_{JA} = 100^{\circ}C/W$ OBSELETE PACKAGE Consider the N8 for Alternate Source</p>	<p>ORDER PART NUMBER</p> <p>LT1126ACN8 LT1126CN8</p> <p>LT1126AMJ8 LT1126MJ8 LT1126CJ8</p>
 <p>TOP VIEW</p> <p>OUT A 1 16 OUT D -IN A 2 15 -IN D +IN A 3 14 +IN D V⁺ 4 13 V⁻ +IN B 5 12 +IN C -IN B 6 11 -IN C OUT B 7 10 OUT C NC 8 9 NC</p> <p>SW PACKAGE 16-LEAD PLASTIC SO WIDE $T_{JMAX} = 140^{\circ}C, \theta_{JA} = 130^{\circ}C/W$</p>	<p>LT1127CSW</p>	 <p>TOP VIEW</p> <p>OUT A 1 14 OUT D -IN A 2 13 -IN D +IN A 3 12 +IN D V⁺ 4 11 V⁻ +IN B 5 10 +IN C -IN B 6 9 -IN C OUT B 7 8 OUT C</p> <p>N PACKAGE 14-LEAD PDIP $T_{JMAX} = 140^{\circ}C, \theta_{JA} = 110^{\circ}C (N)$</p> <p>J PACKAGE 14-LEAD CERAMIC DIP $T_{JMAX} = 160^{\circ}C, \theta_{JA} = 80^{\circ}C/W$ OBSELETE PACKAGE Consider the N for Alternate Source</p>	<p>LT1127ACN LT1127CN</p> <p>LT1127AMJ LT1127MJ LT1127CJ</p>
<p>Order Options Tape and Reel: Add #TR Lead Free: Add #PBF Lead Free Tape and Reel: Add #TRPBF Lead Free Part Marking: http://www.linear.com/leadfree/</p>			

Consult LTC Marketing for parts specified with wider operating temperature ranges.

ELECTRICAL CHARACTERISTICS $V_S = \pm 15V$, $T_A = 25^\circ C$, unless otherwise noted.

SYMBOL	PARAMETER	CONDITIONS (Note 2)	LT1126AM/AC LT1127AM/AC			LT1126M/C LT1127M/C			UNITS
			MIN	TYP	MAX	MIN	TYP	MAX	
V_{OS}	Input Offset Voltage	LT1126		20	70	25	100	μV	
		LT1127		25	90	30	140	μV	
$\frac{\Delta V_{OS}}{\Delta Time}$	Long Term Input Offset Voltage Stability			0.3		0.3		$\mu V/Mo$	
I_{OS}	Input Offset Current	LT1126		5	15	6	20	nA	
		LT1127		6	20	7	30	nA	
I_B	Input Bias Current			± 7	± 20	± 8	± 30	nA	
e_n	Input Noise Voltage	0.1Hz to 10Hz (Notes 8, 9)		70	200	70		nVp-p	
	Input Noise Voltage Density	$f_0 = 10Hz$ (Note 5)		3.0	5.5	3.0	5.5	nV/\sqrt{Hz}	
		$f_0 = 1000Hz$ (Note 3)		2.7	4.2	2.7	4.2	nV/\sqrt{Hz}	
i_n	Input Noise Current Density	$f_0 = 10Hz$		1.3		1.3		pA/\sqrt{Hz}	
		$f_0 = 1000Hz$		0.3		0.3		pA/\sqrt{Hz}	
V_{CM}	Input Voltage Range		± 12.0	± 12.8		± 12.0	± 12.8	V	
CMRR	Common Mode Rejection Ratio	$V_{CM} = \pm 12V$	112	126		106	124	dB	
PSRR	Power Supply Rejection Ratio	$V_S = \pm 4V$ to $\pm 18V$	116	126		110	124	dB	
A_{VOL}	Large Signal Voltage Gain	$R_L \geq 10k\Omega$, $V_0 = \pm 10V$	5.0	17.0		3.0	15.0	$V/\mu V$	
		$R_L \geq 2k\Omega$, $V_0 = \pm 10V$	2.0	4.0		1.5	3.0	$V/\mu V$	
V_{OUT}	Maximum Output Voltage Swing	$R_L \geq 2k\Omega$	± 13.0	± 13.8		± 12.5	± 13.8	V	
SR	Slew Rate	$R_L \geq 2k\Omega$ (Notes 3, 7)	8.0	11		8.0	11	$V/\mu s$	
GBW	Gain-Bandwidth Product	$f_0 = 10kHz$ (Note 3)	45	65		45	65	MHz	
Z_0	Open Loop Output Resistance	$V_0 = 0$, $I_0 = 0$		75		75		Ω	
I_S	Supply Current Per Amplifier			2.6	3.1	2.6	3.1	mA	
	Channel Separation	$f \leq 10Hz$ (Note 9) $V_0 = \pm 10V$, $R_L = 2k\Omega$	134	150		130	150	dB	

The ● denotes the specifications which apply over the full operating temperature range, otherwise specifications are at $V_S = \pm 15V$, $-55^\circ C \leq T_A \leq 125^\circ C$, unless otherwise noted.

SYMBOL	PARAMETER	CONDITIONS (Note 1)	LT1126AM LT1127AM			LT1126M LT1127M			UNITS
			MIN	TYP	MAX	MIN	TYP	MAX	
V_{OS}	Input Offset Voltage	LT1126	●	50	170	60	250	μV	
		LT1127	●	55	190	70	290	μV	
$\frac{\Delta V_{OS}}{\Delta Temp}$	Average Input Offset Voltage Drift	(Note 5)	●	0.3	1.0	0.4	1.5	$\mu V/^\circ C$	
I_{OS}	Input Offset Current	LT1126	●	18	45	20	60	nA	
		LT1127	●	18	55	20	70	nA	
I_B	Input Bias Current		●	± 18	± 55	± 20	± 70	nA	
V_{CM}	Input Voltage Range		●	± 11.3	± 12	± 11.3	± 12	V	
CMRR	Common Mode Rejection Ratio	$V_{CM} = \pm 11.3V$	●	106	122	100	120	dB	
PSRR	Power Supply Rejection Ratio	$V_S = \pm 4V$ to $\pm 18V$	●	110	122	104	120	dB	
A_{VOL}	Large Signal Voltage Gain	$R_L \geq 10k\Omega$, $V_0 = \pm 10V$	●	3.0	10.0	2.0	10.0	$V/\mu V$	
		$R_L \geq 2k\Omega$, $V_0 = \pm 10V$	●	1.0	3.0	0.7	2.0	$V/\mu V$	
V_{OUT}	Maximum Output Voltage Swing	$R_L \geq 2k\Omega$	●	± 12.5	± 13.6	± 12.0	± 13.6	V	
SR	Slew Rate	$R_L \geq 2k\Omega$ (Notes 3, 7)	●	7.2	10	7.0	10	$V/\mu s$	
I_S	Supply Current Per Amplifier		●	2.8	3.5	2.8	3.5	mA	

ELECTRICAL CHARACTERISTICS The ● denotes the specifications which apply over the full operating temperature range, otherwise specifications are at $V_S = \pm 15V$, $0^\circ C \leq T_A \leq 70^\circ C$, unless otherwise noted.

SYMBOL	PARAMETER	CONDITIONS (Note 2)	LT1126AC LT1127AC			LT1126C LT1127C			UNITS
			MIN	TYP	MAX	MIN	TYP	MAX	
V_{OS}	Input Offset Voltage	LT1126 LT1127	●	35 40	120 140	●	45 50	170 210	μV μV
$\Delta V_{OS}/\Delta T$	Average Input Offset Voltage Drift	(Note 5)	●	0.3	1.0	●	0.4	1.5	$\mu V/^\circ C$
I_{OS}	Input Offset Current	LT1126 LT1127	●	6 7	25 35	●	7 8	35 45	nA nA
I_B	Input Bias Current		●	± 8	± 35	●	± 9	± 45	nA
V_{CM}	Input Voltage Range		●	± 11.5	± 12.4	●	± 11.5	± 12.4	V
CMRR	Common Mode Rejection Ratio	$V_{CM} = \pm 11.5V$	●	109	125	●	102	122	dB
PSRR	Power Supply Rejection Ratio	$V_S = \pm 4V$ to $\pm 18V$	●	112	125	●	107	122	dB
A_{VOL}	Large Signal Voltage Gain	$R_L \geq 10k\Omega$, $V_O = \pm 10V$ $R_L \geq 2k\Omega$, $V_O = \pm 10V$	●	4.0 1.5	15.0 3.5	●	2.5 1.0	14.0 2.5	$V/\mu V$ $V/\mu V$
V_{OUT}	Maximum Output Voltage Swing	$R_L \geq 2k\Omega$	●	± 12.5	± 13.7	●	± 12.0	± 13.7	V
SR	Slew Rate	$R_L \geq 2k\Omega$ (Notes 3, 7)	●	7.5	10.5	●	7.3	10.5	$V/\mu s$
I_S	Supply Current Per Amplifier		●	2.7	3.3	●	2.7	3.3	mA

The ● denotes the specifications which apply over the full operating temperature range, otherwise specifications are at $V_S = \pm 15V$, $-40^\circ C \leq T_A \leq 85^\circ C$, unless otherwise noted. (Note 10)

SYMBOL	PARAMETER	CONDITIONS (Note 2)	LT1126AC LT1127AC			LT1126C LT1127C			UNITS
			MIN	TYP	MAX	MIN	TYP	MAX	
V_{OS}	Input Offset Voltage	LT1126 LT1127	●	40 45	140 160	●	50 55	200 240	μV μV
$\Delta V_{OS}/\Delta T$	Average Input Offset Voltage Drift	(Note 5)	●	0.3	1.0	●	0.4	1.5	$\mu V/^\circ C$
I_{OS}	Input Offset Current	LT1126 LT1127	●	15 15	40 50	●	17 17	55 65	nA nA
I_B	Input Bias Current		●	± 15	± 50	●	± 17	± 65	nA
V_{CM}	Input Voltage Range		●	± 11.4	± 12.2	●	± 11.4	± 12.2	V
CMRR	Common Mode Rejection Ratio	$V_{CM} = \pm 11.4V$	●	107	124	●	101	121	dB
PSRR	Power Supply Rejection Ratio	$V_S = \pm 4V$ to $\pm 18V$	●	111	124	●	106	121	dB
A_{VOL}	Large Signal Voltage Gain	$R_L \geq 10k\Omega$, $V_O = \pm 10V$ $R_L \geq 2k\Omega$, $V_O = \pm 10V$	●	3.5 1.2	12.0 3.2	●	2.2 0.8	12.0 2.3	$V/\mu V$ $V/\mu V$
V_{OUT}	Maximum Output Voltage Swing	$R_L \geq 2k\Omega$	●	± 12.5	± 13.6	●	± 12.0	± 13.6	V
SR	Slew Rate	$R_L \geq 2k\Omega$ (Note 7)	●	7.3	10.2	●	7.1	10.2	$V/\mu s$
I_S	Supply Current Per Amplifier		●	2.8	3.4	●	2.8	3.4	mA

Note 1: Absolute Maximum Ratings are those values beyond which the life of a device may be impaired.

Note 2: Typical parameters are defined as the 60% yield of parameter distributions of individual amplifiers; i.e., out of 100 LT1127s (or 100 LT1126s) typically 240 op amps (or 120) will be better than the indicated specification.

Note 3: This parameter is 100% tested for each individual amplifier.

Note 4: This parameter is sample tested only.

Note 5: This parameter is not 100% tested.

Note 6: The inputs are protected by back-to-back diodes. Current limiting resistors are not used in order to achieve low noise. If differential input voltage exceeds $\pm 1.4V$, the input current should be limited to 25mA.

Note 7: Slew rate is measured in $A_V = -10$; input signal is $\pm 1V$, output measured at $\pm 5V$.

Note 8: 0.1Hz to 10Hz noise can be inferred from the 10Hz noise voltage density test. See the test circuit and frequency response curve for 0.1Hz to 10Hz tester in the Applications Information section of the LT1007 or LT1028 datasheets.

Note 9: This parameter is guaranteed but not tested.

Note 10: The LT1126/LT1127 are designed, characterized and expected to meet these extended temperature limits, but are not tested at $-40^\circ C$ and at $85^\circ C$. Guaranteed I grade parts are available. Consult factory.

TYPICAL PERFORMANCE CHARACTERISTICS

The typical behavior of many LT1126/LT1127 parameters is identical to the LT1124/LT1125. Please refer to the LT1124/LT1125 data sheet for the following performance characteristics:

- 0.1Hz to 10Hz Voltage Noise
- 0.01Hz to 1Hz Voltage Noise
- Current Noise vs Frequency
- Input Bias or Offset Current vs Temperature
- Output Short Circuit Current vs Time

- Input Bias Current Over the Common Mode Range
- Voltage Gain vs Temperature
- Input Offset Voltage Drift Distribution
- Offset Voltage Drift with Temperature of Representative Units
- Output Voltage Swing vs Load Current
- Common Mode Limit vs Temperature
- Channel Separation vs Frequency
- Warm-Up Drift
- Power Supply Rejection Ratio vs Frequency

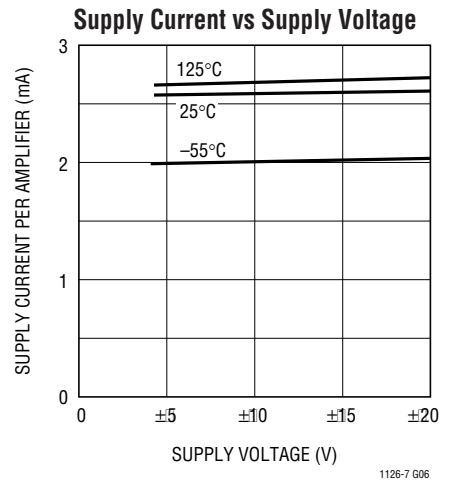
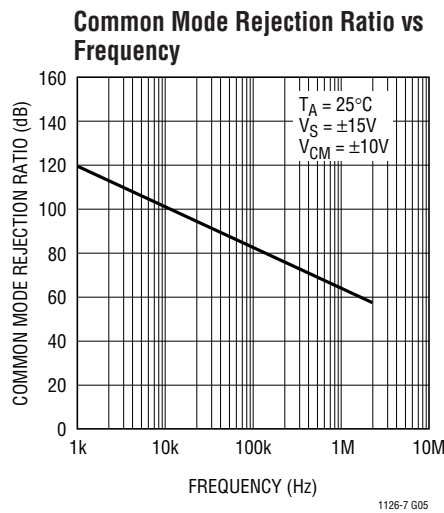
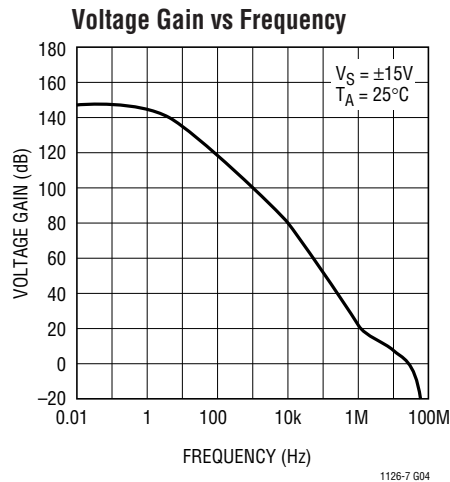
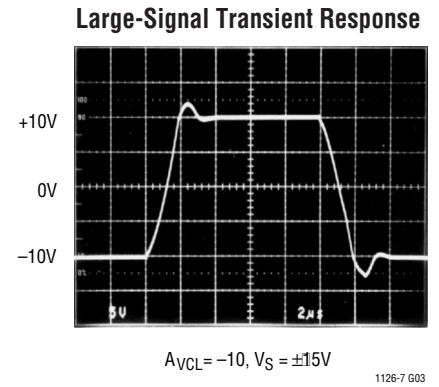
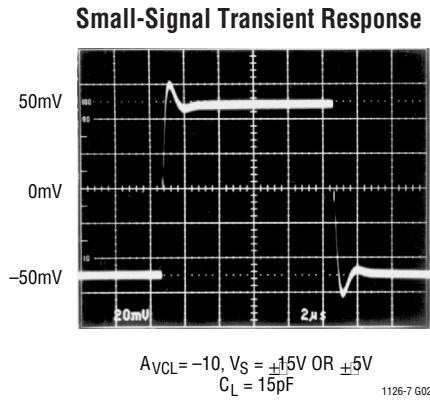
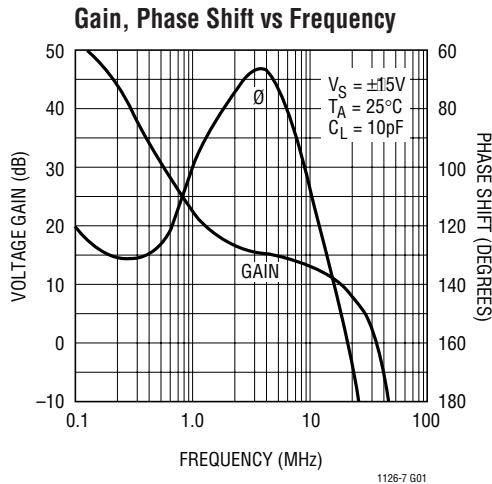

*See LT1115 data sheet for definition of CCIF testing

TYPICAL PERFORMANCE CHARACTERISTICS

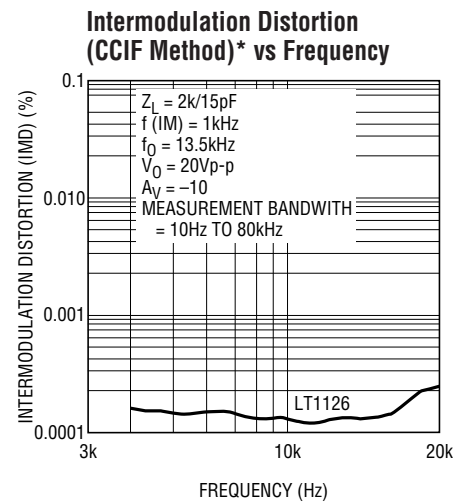
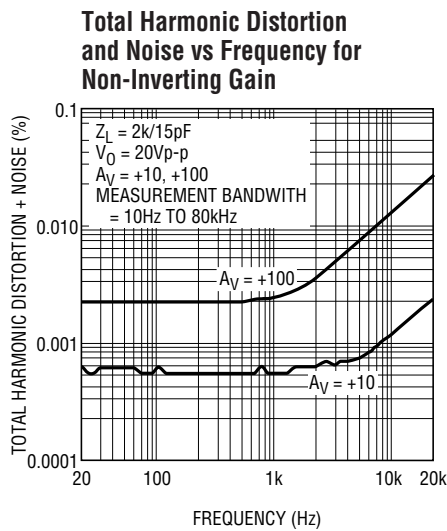
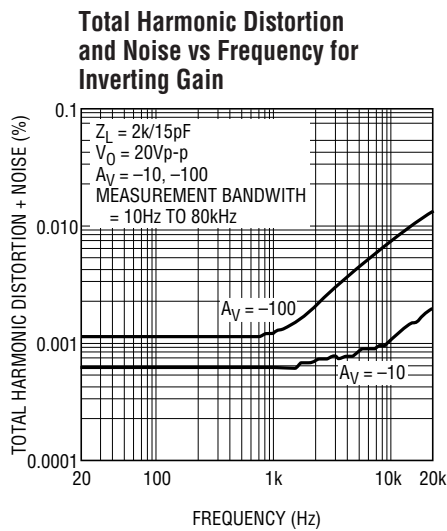

*See LT1115 data sheet for definition of CCIF testing

APPLICATIONS INFORMATION

Matching Specifications

In many applications the performance of a system depends on the matching between two op amps, rather than the individual characteristics of the two devices. The three op amp instrumentation amplifier configuration shown in this data sheet is an example. Matching characteristics are not 100% tested on the LT1126/LT1127.

Some specifications are guaranteed by definition. For example, $70\mu V$ maximum offset voltage implies that mismatch cannot be more than $140\mu V$. $112dB$ ($= 2.5\mu V/V$) CMRR means that worst case CMRR match is $106dB$ ($5\mu V/V$). However, the following table can be used to estimate the expected matching performance between the two sides of the LT1126, and between amplifiers A and D, and between amplifiers B and C of the LT1127.

Expected Match

PARAMETER		LT1126A/M/C LT1127A/M/C		LT1126M/C LT1127M/C		UNITS
		50% YIELD	98% YIELD	50% YIELD	98% YIELD	
V_{OS} Match, ΔV_{OS}	LT1126	20	110	30	130	μV
	LT1127	30	150	50	180	μV
Temperature Coefficient Match		0.35	1.0	0.5	1.5	$\mu V/^\circ C$
Average Non-Inverting I_B		6	18	7	25	nA
Match of Non-Inverting I_B		7	22	8	30	nA
CMRR Match		126	115	123	112	dB
PSRR Match		127	118	127	114	dB

APPLICATIONS INFORMATION

High Speed Operation

When the feedback around the op amp is resistive (R_F), a pole will be created with R_F , the source resistance and capacitance (R_S, C_S), and the amplifier input capacitance ($C_{IN} \approx 2\text{pF}$). In low closed loop gain configurations and

with R_S and R_F in the kilohm range, this pole can create excess phase shift and even oscillation. A small capacitor (C_F) in parallel with R_F eliminates this problem. With $R_S (C_S + C_{IN}) = R_F C_F$, the effect of the feedback pole is completely removed.

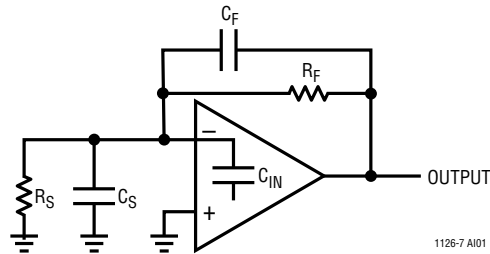

1126-7 AI01

TYPICAL APPLICATIONS

Gain 1000 Amplifier with 0.01% Accuracy, DC to 5Hz

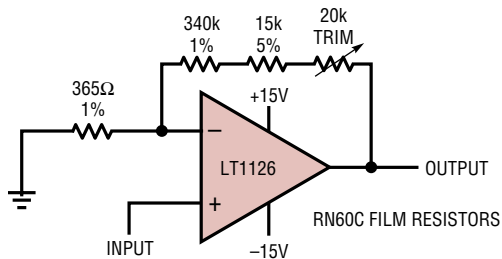

THE HIGH GAIN AND WIDE BANDWIDTH OF THE LT1126/LT1127 IS USEFUL IN LOW FREQUENCY HIGH CLOSED LOOP GAIN AMPLIFIER APPLICATIONS. A TYPICAL PRECISION OP AMP MAY HAVE AN OPEN LOOP GAIN OF ONE MILLION WITH 500kHz BANDWIDTH. AS THE GAIN ERROR PLOT SHOWS, THIS DEVICE IS CAPABLE OF 0.1% AMPLIFYING ACCURACY UP TO 0.3Hz ONLY. EVEN INSTRUMENTATION RANGE SIGNALS CAN VARY AT A FASTER RATE. THE LT1126/LT1127 "GAIN PRECISION — BANDWIDTH PRODUCT" IS 330 TIMES HIGHER, AS SHOWN.

1126-7 TA02

Gain Error vs Frequency Closed Loop Gain = 1000

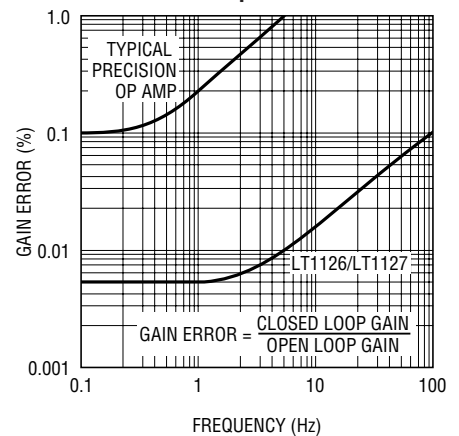

1126-7 TA03

TYPICAL APPLICATIONS

Low Noise, Wideband, Gain = 100 Amplifier with High Input Impedance

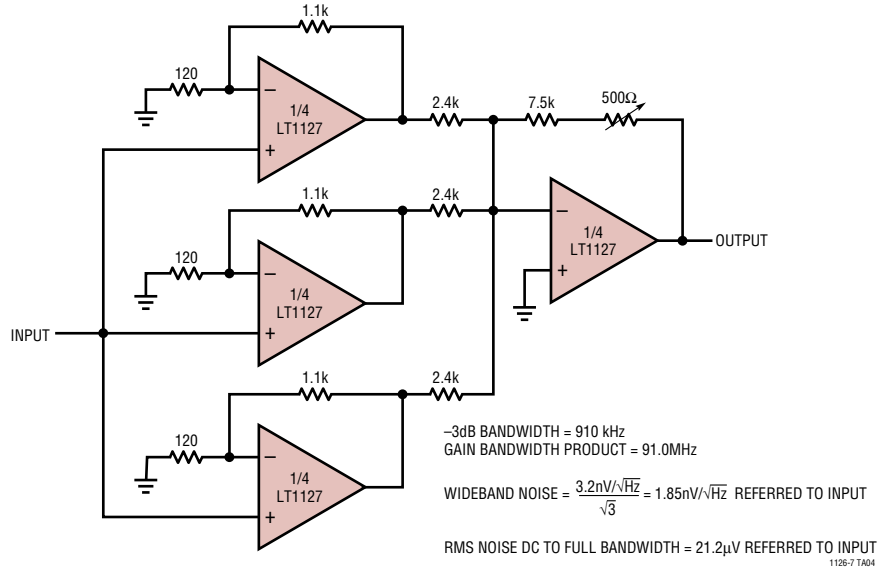

PACKAGE DESCRIPTION

J8 Package 8-Lead CERDIP (Narrow .300 Inch, Hermetic) (Reference LTC DWG # 05-08-1110)

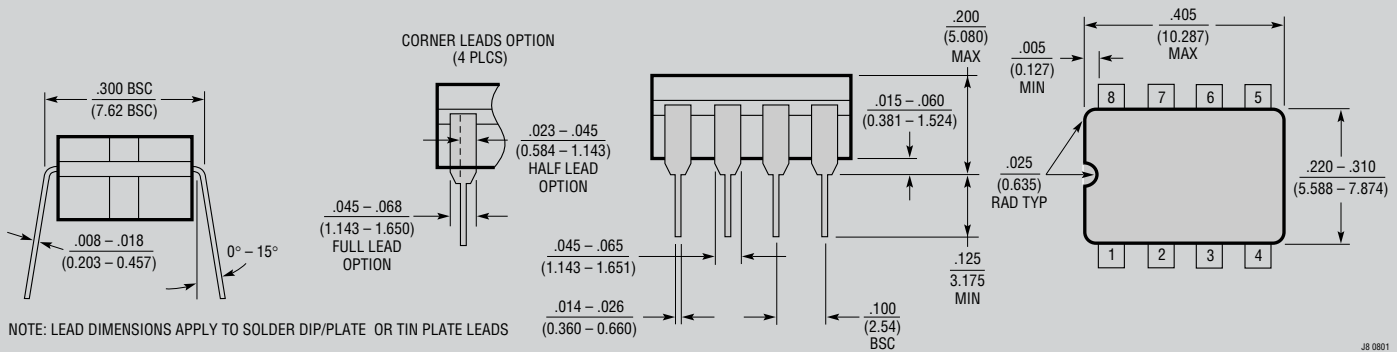

OBSELETE PACKAGE

PACKAGE DESCRIPTION

N8 Package 8-Lead PDIP (Narrow .300 Inch) (Reference LTC DWG # 05-08-1510)

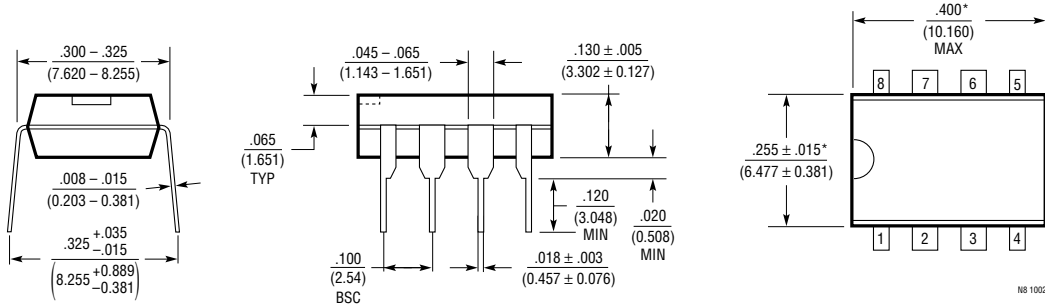

NOTE:
1. DIMENSIONS ARE $\frac{\text{INCHES}}{\text{MILLIMETERS}}$
*THESE DIMENSIONS DO NOT INCLUDE MOLD FLASH OR PROTRUSIONS.
MOLD FLASH OR PROTRUSIONS SHALL NOT EXCEED .010 INCH (0.254mm)

S8 Package 8-Lead Plastic Small Outline (Narrow .150 Inch) (Reference LTC DWG # 05-08-1610)

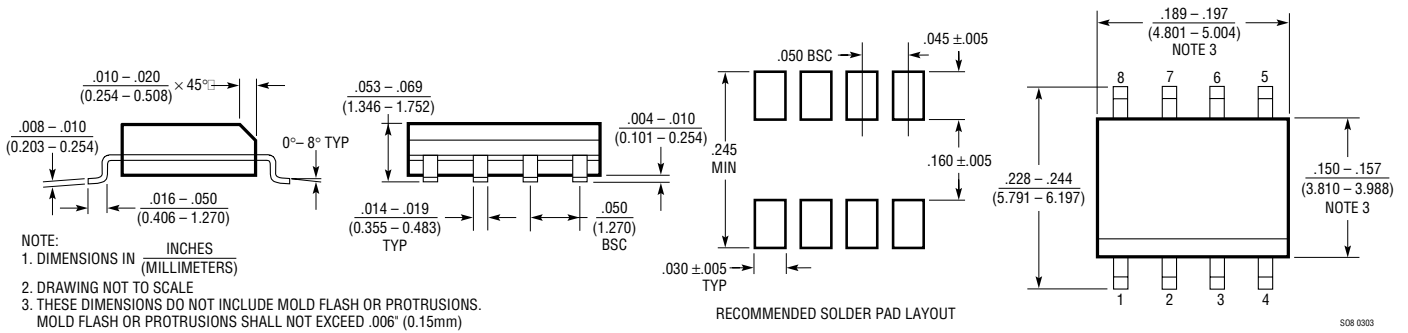

NOTE:
1. DIMENSIONS IN $\frac{\text{INCHES}}{\text{MILLIMETERS}}$
2. DRAWING NOT TO SCALE
3. THESE DIMENSIONS DO NOT INCLUDE MOLD FLASH OR PROTRUSIONS.
MOLD FLASH OR PROTRUSIONS SHALL NOT EXCEED .006" (0.15mm)

J Package 14-Lead Cerdip (Narrow .300 Inch, Hermetic) (Reference LTC DWG # 05-08-1110)

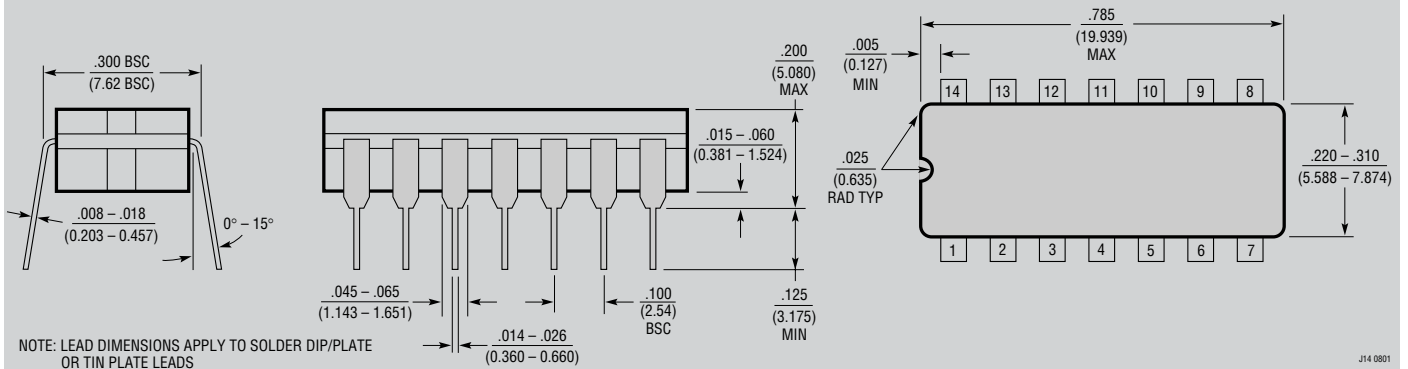

NOTE: LEAD DIMENSIONS APPLY TO SOLDER DIP/PLATE OR TIN PLATE LEADS

OBsolete PACKAGE

PACKAGE DESCRIPTION

N Package
14-Lead PDIP (Narrow .300 Inch)
 (Reference LTC DWG # 05-08-1510)

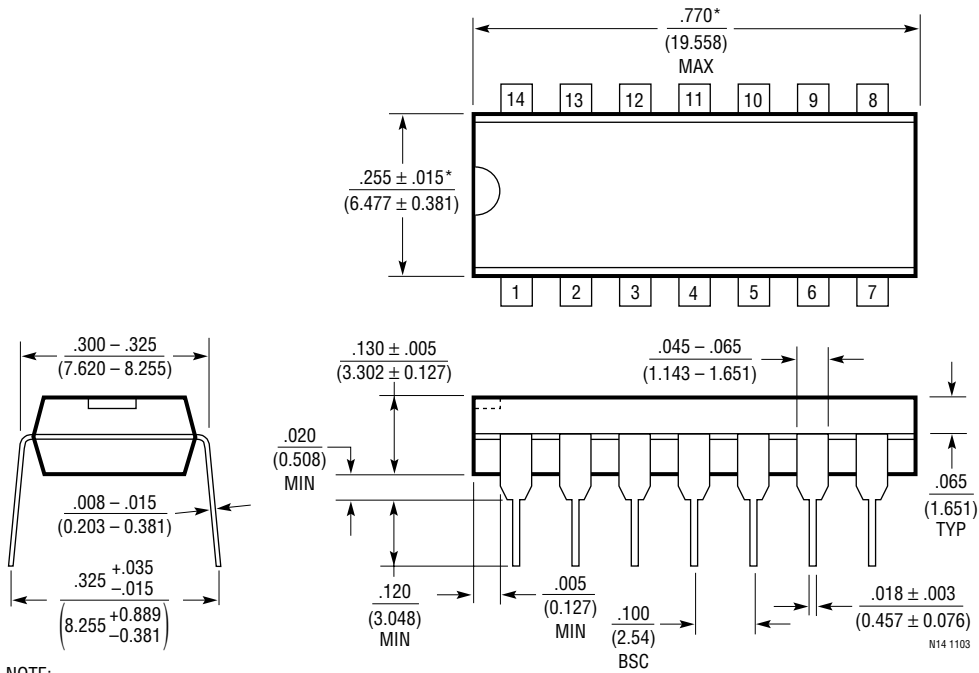

NOTE:
 1. DIMENSIONS ARE $\frac{\text{INCHES}}{\text{MILLIMETERS}}$

*THESE DIMENSIONS DO NOT INCLUDE MOLD FLASH OR PROTRUSIONS.
 MOLD FLASH OR PROTRUSIONS SHALL NOT EXCEED .010 INCH (0.254mm)

PACKAGE DESCRIPTION

SW Package 16-Lead Plastic Small Outline (Wide .300 Inch) (Reference LTC DWG # 05-08-1620)

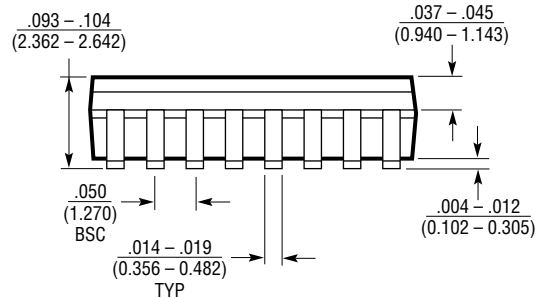
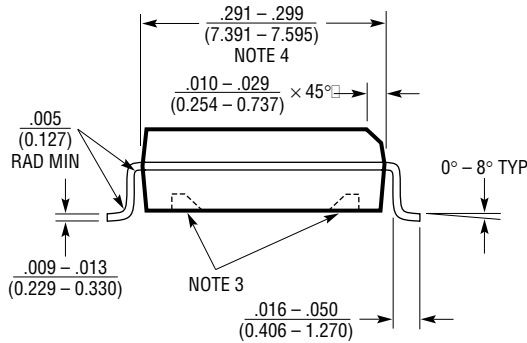
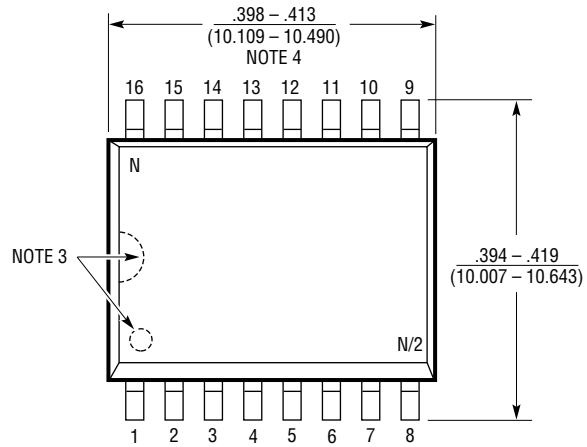
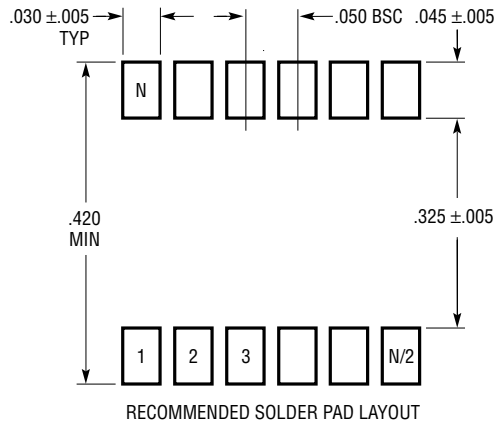

- NOTE:
1. DIMENSIONS IN $\frac{\text{INCHES}}{\text{MILLIMETERS}}$
 2. DRAWING NOT TO SCALE
 3. PIN 1 IDENT, NOTCH ON TOP AND CAVITIES ON THE BOTTOM OF PACKAGES ARE THE MANUFACTURING OPTIONS. THE PART MAY BE SUPPLIED WITH OR WITHOUT ANY OF THE OPTIONS
 4. THESE DIMENSIONS DO NOT INCLUDE MOLD FLASH OR PROTRUSIONS. MOLD FLASH OR PROTRUSIONS SHALL NOT EXCEED .006" (0.15mm)

S16 (WIDE) 0502

SCHEMATIC DIAGRAM (1/2 LT1126, 1/4 LT1127)

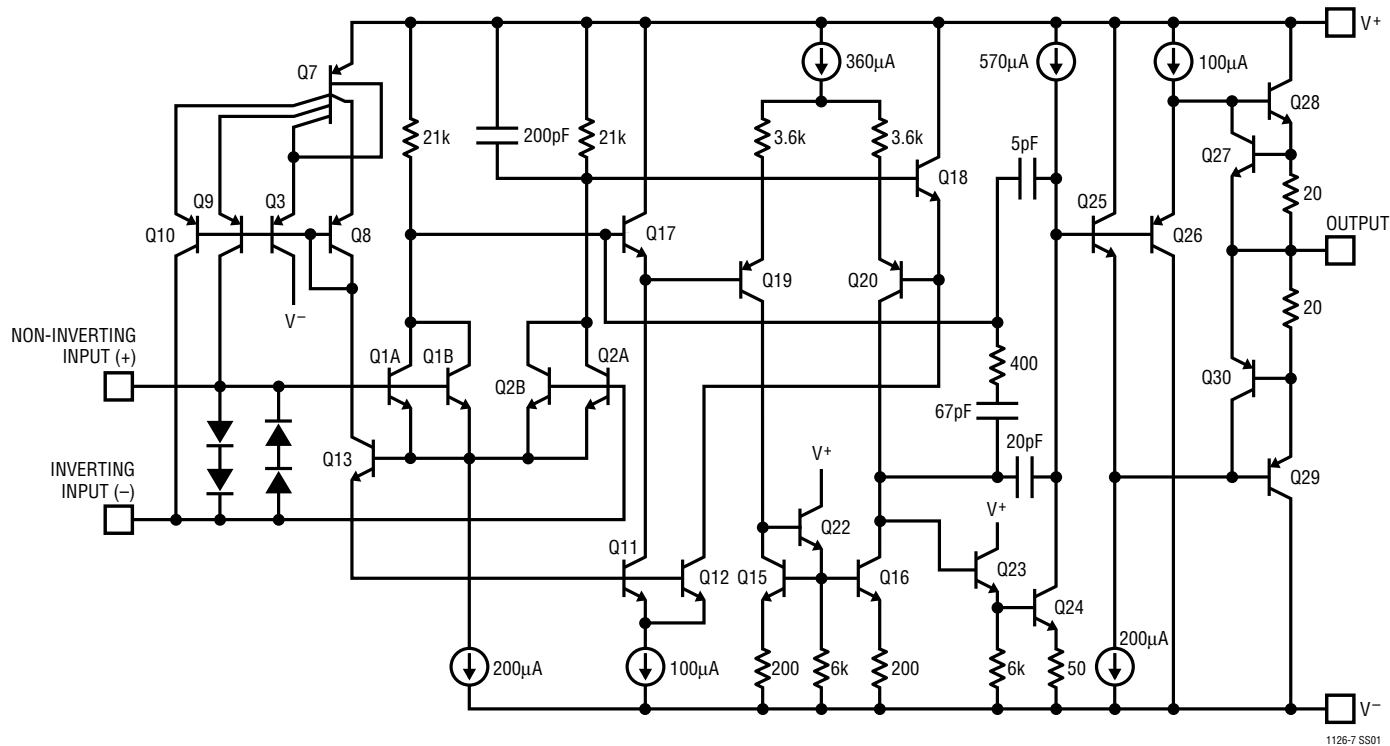

1126-7 5S01

RELATED PARTS

PART NUMBER	DESCRIPTION	COMMENTS
LT1124/LT1125	Dual/Quad Low Noise High Speed Precision Op Amps	Unity Gain Stable
LT1037	Low Noise, High Speed Precision Op Amps	60MHz GBW, 11V/µs Slew Rate
LT1678/LT1679	Dual/Quad Low Noise Rail-to-Rail Precision Op Amps	20MHz GBW, 100µV V _{OS}
LT1028	Ultralow Noise Precision High Speed Op Amps	1.1nV/√Hz Max, 0.85 µV/Hz Typ
LT6230	215MHz, Rail-to-Rail Output Low Noise Op Amps	1.1nV/√Hz, 3.5mA Supply Current

11267fa

Компания «Океан Электроники» предлагает заключение долгосрочных отношений при поставках импортных электронных компонентов на взаимовыгодных условиях!

Наши преимущества:

- Поставка оригинальных импортных электронных компонентов напрямую с производств Америки, Европы и Азии, а так же с крупнейших складов мира;
- Широкая линейка поставок активных и пассивных импортных электронных компонентов (более 30 млн. наименований);
- Поставка сложных, дефицитных, либо снятых с производства позиций;
- Оперативные сроки поставки под заказ (от 5 рабочих дней);
- Экспресс доставка в любую точку России;
- Помощь Конструкторского Отдела и консультации квалифицированных инженеров;
- Техническая поддержка проекта, помощь в подборе аналогов, поставка прототипов;
- Поставка электронных компонентов под контролем ВП;
- Система менеджмента качества сертифицирована по Международному стандарту ISO 9001;
- При необходимости вся продукция военного и аэрокосмического назначения проходит испытания и сертификацию в лаборатории (по согласованию с заказчиком);
- Поставка специализированных компонентов военного и аэрокосмического уровня качества (Xilinx, Altera, Analog Devices, Intersil, Interpoint, Microsemi, Actel, Aeroflex, Peregrine, VPT, Syfer, Eurofarad, Texas Instruments, MS Kennedy, Miteq, Cobham, E2V, MA-COM, Hittite, Mini-Circuits, General Dynamics и др.);

Компания «Океан Электроники» является официальным дистрибьютором и эксклюзивным представителем в России одного из крупнейших производителей разъемов военного и аэрокосмического назначения «JONHON», а так же официальным дистрибьютором и эксклюзивным представителем в России производителя высокотехнологичных и надежных решений для передачи СВЧ сигналов «FORSTAR».



JONHON

«JONHON» (основан в 1970 г.)

Разъемы специального, военного и аэрокосмического назначения:

(Применяются в военной, авиационной, аэрокосмической, морской, железнодорожной, горно- и нефтедобывающей отраслях промышленности)

«FORSTAR» (основан в 1998 г.)

ВЧ соединители, коаксиальные кабели,
кабельные сборки и микроволновые компоненты:

(Применяются в телекоммуникациях гражданского и специального назначения, в средствах связи, РЛС, а так же военной, авиационной и аэрокосмической отраслях промышленности).



Телефон: 8 (812) 309-75-97 (многоканальный)

Факс: 8 (812) 320-03-32

Электронная почта: ocean@oceanchips.ru

Web: <http://oceanchips.ru/>

Адрес: 198099, г. Санкт-Петербург, ул. Калинина, д. 2, корп. 4, лит. А