



**Compliance with RoHS Directive**

**FEATURES**

- Excellent high frequency characteristics (50Ω, to 26.5GHz)**
- SPDT, Transfer and SP6T types are available.**
- High sensitivity**  
Nominal operating power:  
840 mW (SPDT/SP6T, Fail-safe type, with indicator)  
1,540 mW (Transfer, Fail-safe type, with indicator)  
\*Without 24V type
- Long-lasting life: min. 5 × 10<sup>6</sup>**
- With termination type is added. (SP6T)**  
Thanks to the addition of termination, steady high frequency characteristics can be maintained when contacts are either open or closed and this contributes to increase system reliability.

6. + COM type is available.

**TYPICAL APPLICATIONS**

**Wireless and mobile communication**

- Cellular phone base station
- Amplifier switching

**Digital broadcasting**

- Broadcasting relay station
- Broadcasting equipment

**Measuring instrument**

**All types of inspection equipment**

Please inquire beforehand if you are thinking of using this product in applications that involve low level load or high frequency of switching.

**HIGH FREQUENCY CHARACTERISTICS (Impedance 50Ω)**

Frequency	to 1 GHz	1 to 4 GHz	4 to 8 GHz*1	8 to 12.4 GHz	12.4 to 18 GHz	18 to 26.5 GHz*2
V.S.W.R. (max.)	1.1	1.15	1.25	1.35	1.5	1.7
V.S.W.R. (SP6T With termination) (max.)	1.20		1.40	1.50	—	—
Insertion loss (dB. max.)	0.2		0.3	0.4	0.5	0.8
Isolation (dB. min.)	85	80	70	65	60	55

Notes: \*1 The 6GHz type only has the above characteristics up to 6GHz.  
\*2 18 to 26.5GHz characteristics can be applied 26.5GHz type only (SPDT, Transfer)

**ORDERING INFORMATION**

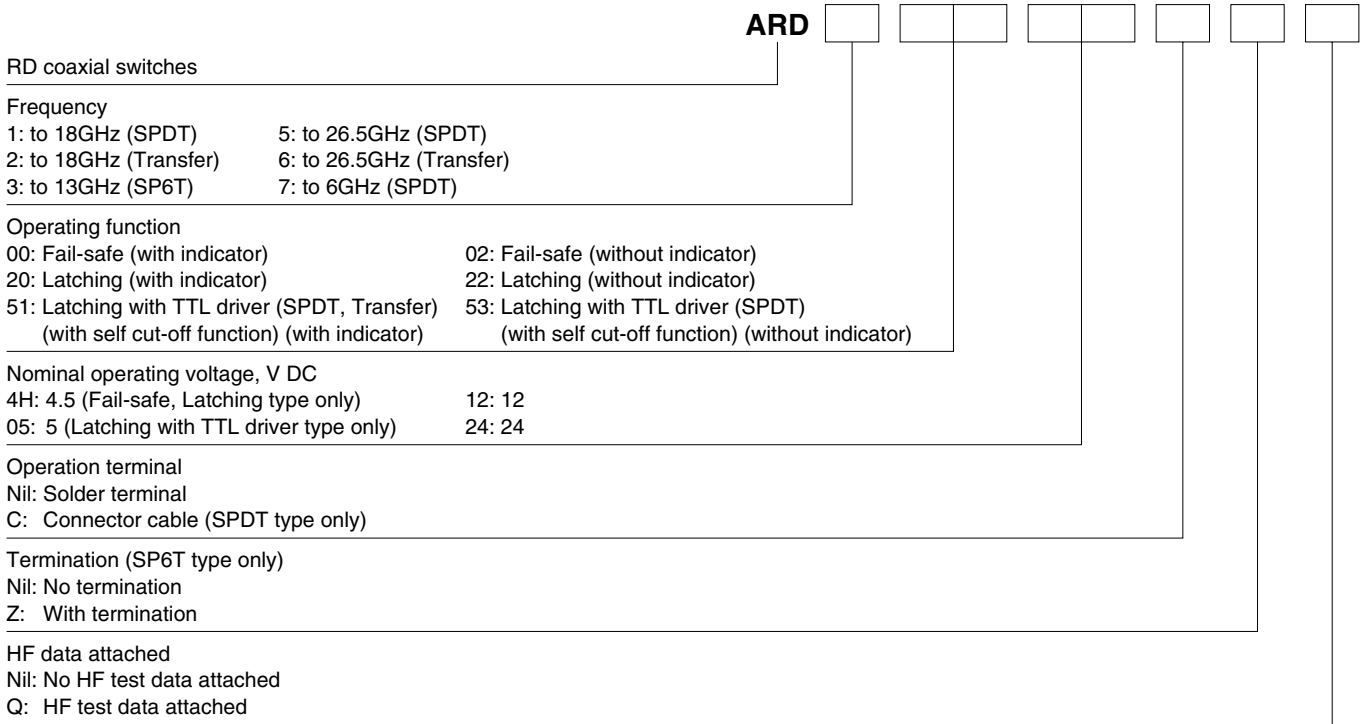

# RD (ARD)

## TYPES

### 1. SPDT

#### 1) Solder terminal

Operating function	Nominal operating voltage, V DC	<b>New</b> 6GHz type	18GHz type		26.5GHz type	
		No HF datasheet attached	No HF datasheet attached	HF datasheet attached	No HF datasheet attached	HF datasheet attached
Fail-safe (with indicator)	4.5	ARD7004H	ARD1004H	ARD1004HQ	ARD5004H	ARD5004HQ
	12	ARD70012	ARD10012	ARD10012Q	ARD50012	ARD50012Q
	24	ARD70024	ARD10024	ARD10024Q	ARD50024	ARD50024Q
Latching (with indicator)	4.5	ARD7204H	ARD1204H	ARD1204HQ	ARD5204H	ARD5204HQ
	12	ARD72012	ARD12012	ARD12012Q	ARD52012	ARD52012Q
	24	ARD72024	ARD12024	ARD12024Q	ARD52024	ARD52024Q
Latching with TTL driver (with self cut-off function) (with indicator)	5	ARD75105	ARD15105	ARD15105Q	ARD55105	ARD55105Q
	12	ARD75112	ARD15112	ARD15112Q	ARD55112	ARD55112Q
	24	ARD75124	ARD15124	ARD15124Q	ARD55124	ARD55124Q
Fail-safe (without indicator)	4.5	ARD7024H	—	—	—	—
	12	ARD70212				
	24	ARD70224				
Latching (without indicator)	4.5	ARD7224H	—	—	—	—
	12	ARD72212				
	24	ARD72224				
Latching with TTL driver (with self cut-off function) (without indicator)	5	ARD75305	—	—	—	—
	12	ARD75312				
	24	ARD75324				

Note: Standard packing; Carton: 1 pc. Case: 20 pcs.

#### 2) Connector cable

Operating function	Nominal operating voltage, V DC	18GHz type		26.5GHz type	
		No HF datasheet attached	HF datasheet attached	No HF datasheet attached	HF datasheet attached
Fail-safe	4.5	ARD1004HC	ARD1004HCQ	ARD5004HC	ARD5004HCQ
	12	ARD10012C	ARD10012CQ	ARD50012C	ARD50012CQ
	24	ARD10024C	ARD10024CQ	ARD50024C	ARD50024CQ
Latching	4.5	ARD1204HC	ARD1204HCQ	ARD5204HC	ARD5204HCQ
	12	ARD12012C	ARD12012CQ	ARD52012C	ARD52012CQ
	24	ARD12024C	ARD12024CQ	ARD52024C	ARD52024CQ
Latching with TTL driver (with self cut-off function)	5	ARD15105C	ARD15105CQ	ARD55105C	ARD55105CQ
	12	ARD15112C	ARD15112CQ	ARD55112C	ARD55112CQ
	24	ARD15124C	ARD15124CQ	ARD55124C	ARD55124CQ

Note: Standard packing; Carton: 1 pc. Case: 10 pcs.

### 2. Transfer

Operating function	Nominal operating voltage, V DC	18GHz type		26.5GHz type	
		No HF datasheet attached	HF datasheet attached	No HF datasheet attached	HF datasheet attached
Fail-safe	4.5	ARD2004H	ARD2004HQ	ARD6004H	ARD6004HQ
	12	ARD20012	ARD20012Q	ARD60012	ARD60012Q
	24	ARD20024	ARD20024Q	ARD60024	ARD60024Q
Latching	4.5	ARD2204H	ARD2204HQ	ARD6204H	ARD6204HQ
	12	ARD22012	ARD22012Q	ARD62012	ARD62012Q
	24	ARD22024	ARD22024Q	ARD62024	ARD62024Q
Latching with TTL driver (with self cut-off function)	5	ARD25105	ARD25105Q	ARD65105	ARD65105Q
	12	ARD25112	ARD25112Q	ARD65112	ARD65112Q
	24	ARD25124	ARD25124Q	ARD65124	ARD65124Q

Note: Standard packing; Carton: 1 pc. Case: 10 pcs.

### 3. SP6T

Operating function	Nominal operating voltage, V DC	13GHz type	
		No HF datasheet attached	HF datasheet attached
Fail-safe	4.5	ARD3004H	ARD3004HQ
	12	ARD30012	ARD30012Q
	24	ARD30024	ARD30024Q
Latching	4.5	ARD3204H	ARD3204HQ
	12	ARD32012	ARD32012Q
	24	ARD32024	ARD32024Q

Note: Standard packing; Carton: 1 pc. Case: 5 pcs.

**4. SP6T (with termination)**

Operating function	Nominal operating voltage, V DC	13GHz type	
		No HF datasheet attached	HF datasheet attached
Fail-safe	4.5	ARD3004HZ	ARD3004HZQ
	12	ARD30012Z	ARD30012ZQ
	24	ARD30024Z	ARD30024ZQ
Latching	4.5	ARD3204HZ	ARD3204HZQ
	12	ARD32012Z	ARD32012ZQ
	24	ARD32024Z	ARD32024ZQ

Note: Standard packing; Carton: 1 pc. Case: 5 pcs.

**RATING****1. Coil data****(1) SPDT****1) Fail-safe type**

Nominal operating voltage, V DC	Nominal operating current, mA (+10%/–15%) (at 20°C 68°F)		Nominal power consumption, mW	
	With indicator	Without indicator	With indicator	Without indicator
4.5	186.7	155.6	840	700
12	70.0	58.3		
24	40.4	29.2	970	

**2) Latching type**

Nominal operating voltage, V DC	Nominal operating current, mA (+10%/–15%) (at 20°C 68°F)		Nominal power consumption, mW	
	With indicator	Without indicator	With indicator	Without indicator
4.5	155.6	111.1	700	500
12	62.5	41.7	750	
24	37.5	16.7	900	

**3) Latching with TTL driver type**

Nominal operating voltage, V DC	TTL logic level (see TTL logic level range)		Electronic self cut-off	Switching frequency
	ON	OFF		
5	2.4 to 5.5V	0 to 0.5V	Available	Max. 180 cpm (ON time : OFF time = 1 : 1)
12				
24				

**(2) Transfer****1) Fail-safe type**

Nominal operating voltage, V DC	Nominal operating current, mA (+10%/–15%) (at 20°C 68°F)	Nominal power consumption, mW
4.5	342.2	1540
12	128.3	
24	69.6	1670

**2) Latching type**

Nominal operating voltage, V DC	Nominal operating current, mA (+10%/–15%) (at 20°C 68°F)	Nominal power consumption, mW
4.5	266.7	1200
12	104.2	1250
24	58.3	1400

**3) Latching with TTL driver type (with self cut-off function)**

Nominal operating voltage, V DC	TTL logic level (see TTL logic level range)		Electronic self cut-off	Switching frequency
	ON	OFF		
5	2.4 to 5.5V	0 to 0.5V	Available	Max. 180 cpm (ON time : OFF time = 1 : 1)
12				
24				

**(3) SP6T and SP6T (with termination type)****1) Fail-safe type**

Nominal operating voltage, V DC	Nominal operating current, mA (+10%/–15%) (at 20°C 68°F)	Nominal power consumption, mW
4.5	186.7	840
12	70.0	
24	40.4	970

**2) Latching type**

Nominal operating voltage, V DC	Nominal operating current, mA (+10%/–15%) (at 20°C 68°F)	Nominal power consumption, mW
4.5	SET: 155.6 / RESET (ALL): 933.6	SET: 700 / RESET (ALL): 4,200
12	SET: 62.5 / RESET (ALL): 375.0	SET: 750 / RESET (ALL): 4,500
24	SET: 37.5 / RESET (ALL): 225.0	SET: 900 / RESET (ALL): 5,400

# RD (ARD)

## • Operating voltage range

### 1) Fail-safe type

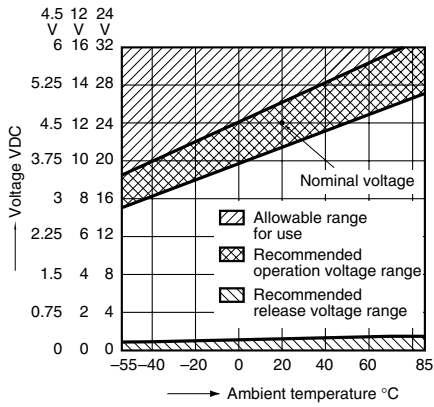

### 2) Latching type

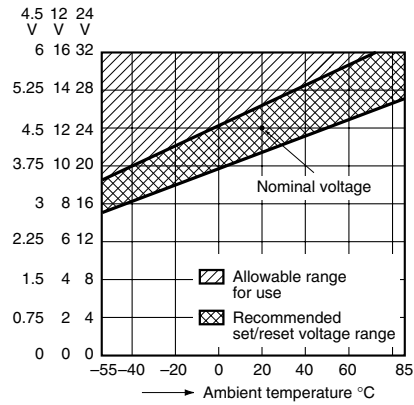

### 3) Latching with TTL driver type (with self cut-off function)

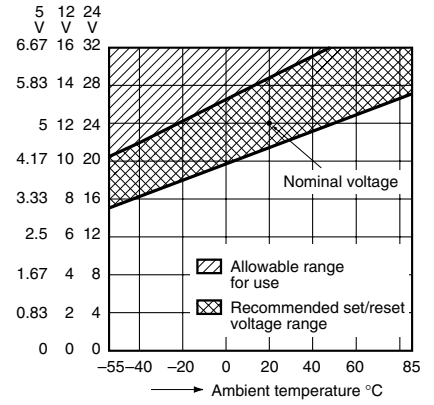

### 4) TTL Logic level range

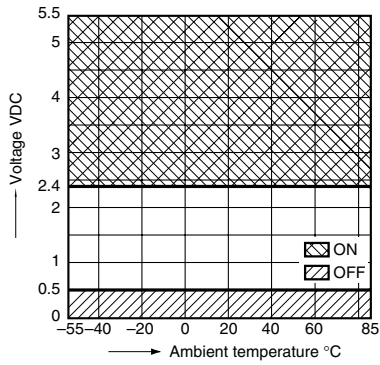

Note: Please consult us for use that is outside this range.

## 2. Specifications

### 1) SPDT/Transfer

Characteristics	Item	Specifications					
		SPDT			Transfer		
Contact	Arrangement	SPDT			Transfer		
	Contact material	Gold plating					
	Initial contact resistance	Max. 100mΩ (By voltage drop 6V DC 1A)					
Rating	Contact input power	120W (at 3GHz) (V.S.W.R. 1.15 or less, no contact switching, ambient temperature 40°C 104°F [SPDT], 25°C 77°F [Transfer])*1					
	Nominal operating power	Fail-safe	840mW (4.5V, 12V DC), 970mW (24V DC)			1,540mW (4.5V, 12V DC), 1,670mW (24V DC)	
		Latching	700mW (4.5V DC), 750mW (12V DC), 900mW (24V DC)			1,200mW (4.5V DC), 1,250mW (12V DC), 1,400mW (24V DC)	
Indicator rating (with indicator type only)	Contact rating	Max. 30V 100mA					
	Initial contact resistance	Max. 1Ω (Measured by 5V 100mA)					
	Min. switching capacity (Reference value)	3V DC, 0.1mA (5 × 10 <sup>6</sup> , Reliability level: 10% (3kΩ))					
High frequency characteristics (Impedance 50Ω)		to 1 GHz	1 to 4 GHz	4 to 8 GHz*2	8 to 12.4 GHz	12.4 to 18 GHz	18 to 26.5 GHz*3
	V.S.W.R. (max.)	1.1	1.15	1.25	1.35	1.5	1.7
	Insertion loss (dB, max.)	0.2		0.3	0.4	0.5	0.8
	Isolation (dB, min.)	85	80	70	65	60	55
Electrical characteristics	Insulation resistance (Initial)		Min. 1,000 MΩ (at 500 V DC) Measurement at same location as "breakdown voltage (Initial)" section.				
	Breakdown voltage (Initial)	Between open contacts	500 Vrms for 1 min. (Detection current: 10mA)				
		Between contact and coil	500 Vrms for 1 min. (Detection current: 10mA)				
		Between contact and earth terminal	500 Vrms for 1 min. (Detection current: 10mA)				
		Between coil and earth terminal	500 Vrms for 1 min. (Detection current: 10mA)				
Time characteristics (at 20°C 68°F)	Operate time		Max. 15ms (Nominal operating voltage applied to the coil, excluding contact bounce time.)		Max. 20ms (Nominal operating voltage applied to the coil, excluding contact bounce time.)		
Mechanical characteristics	Shock resistance	Functional	Min. 500 m/s <sup>2</sup> (Half-wave pulse of sine wave: 11ms, detection time: 10μs.)				
		Destructive	Min. 1,000 m/s <sup>2</sup> (Half-wave pulse of sine wave: 11ms.)				
	Vibration resistance	Functional	10 to 55 Hz at double amplitude of 3mm (Detection time: 10μs.)				
		Destructive	10 to 55 Hz at double amplitude of 5mm				
Expected life	Mechanical		6GHz type: Min. 10 <sup>6</sup> 18 and 26.5GHz type: Min. 5 × 10 <sup>6</sup> (All types, at 180 cpm)		Min. 5 × 10 <sup>6</sup> (at 180 cpm)		
	Electrical	High frequency contact (Hot switch)	6GHz type: Min. 10 <sup>6</sup> 18 and 26.5GHz type: Min. 5 × 10 <sup>6</sup> (All types, 5W to 3GHz, impedance 50Ω, V.S.W.R.; max. 1.2) (at 20 cpm)		Min. 5 × 10 <sup>6</sup> (5W to 3GHz, impedance 50Ω, V.S.W.R.; max. 1.2) (at 20 cpm)		
		Indicator (with indicator type only)	5 V DC, 10 mA, Min. 10 <sup>6</sup> (at 20 cpm)				
Conditions	Conditions for operation, transport and storage*4		Ambient temperature: -55°C to +85°C -67°F to +185°F Humidity: 5 to 85% R.H. (Not freezing and condensing at low temperature)				
Unit weight	Approx. 50g 1.76oz			Approx. 110g 3.88oz			

Notes: \*1 Factors such as heating of the connected connector influence the high frequency characteristics; therefore, please verify under actual conditions of use.

\*2 The 6GHz type only has the above characteristics up to 6GHz.

\*3 18 to 26.5GHz characteristics can be applied 26.5GHz type only (SPDT, Transfer)

\*4 The upper operation ambient temperature limit is the maximum temperature that can satisfy the coil temperature rise value. Refer to [6] AMBIENT ENVIRONMENT in GENERAL APPLICATION GUIDELINES.

# RD (ARD)

## 2) SP6T

Characteristics	Item		Specifications			
Contact	Arrangement		SP6T			
	Contact material		Gold plating			
	Initial contact resistance		Max. 100mΩ (By voltage drop 6V DC 1A)			
Rating	Contact input power	No termination	120 W (at 3GHz) (V.S.W.R. 1.15 or less, no contact switching, ambient temperature 25°C 77°F)*1			
		With termination	2W (at 3GHz) (V.S.W.R. 1.15 or less, no contact switching, ambient temperature 25°C 77°F)*1			
	Nominal operating power	Fail-safe	840mW (4.5V, 12V DC), 970mW (24V DC)			
		Latching	700mW (4.5V DC), 750mW (12V DC), 900mW (24V DC)			
Indicator rating	Contact rating		Max. 30V 100mA			
	Initial contact resistance		Max. 1Ω (Measured by 5V 100mA)			
	Min. switching capacity (Reference value)		3V DC, 0.1mA (5 × 10 <sup>6</sup> , Reliability level: 10% (3kΩ))			
High frequency characteristics (Impedance 50Ω)			to 1 GHz	1 to 4 GHz	4 to 8 GHz	8 to 13 GHz
	V.S.W.R. (max.)	No termination	1.1	1.15	1.25	1.35
		With termination	1.20		1.40	1.50
	Insertion loss (dB, max.)		0.2		0.3	0.4
	Isolation (dB, min.)		85	80	70	65
Electrical characteristics	Insulation resistance (Initial)		Min. 1,000 MΩ (at 500 V DC) Measurement at same location as "breakdown voltage (Initial)" section.			
	Breakdown voltage (Initial)	Between open contacts	500 Vrms for 1 min. (Detection current: 10mA)			
		Between contact and coil	500 Vrms for 1 min. (Detection current: 10mA)			
		Between contact and earth terminal	500 Vrms for 1 min. (Detection current: 10mA)			
		Between coil and earth terminal	500 Vrms for 1 min. (Detection current: 10mA)			
Time characteristics (at 20°C 68°F)	Operate time		Max. 20ms (Nominal operating voltage applied to the coil, excluding contact bounce time.)			
Mechanical characteristics	Shock resistance	Functional	Min. 500 m/s <sup>2</sup> (Half-wave pulse of sine wave: 11ms, detection time: 10μs.)			
		Destructive	Min. 1,000 m/s <sup>2</sup> (Half-wave pulse of sine wave: 11ms.)			
	Vibration resistance	Functional	10 to 55 Hz at double amplitude of 3mm (Detection time: 10μs.)			
		Destructive	10 to 55 Hz at double amplitude of 5mm			
Expected life	Mechanical		Min. 5 × 10 <sup>6</sup> (at 180 cpm)			
	Electrical	High frequency contact (Hot switch)	No termination	Min. 5 × 10 <sup>6</sup> (5W to 3GHz, impedance 50Ω, V.S.W.R.; max. 1.2) (at 20 cpm)		
		With termination	Min. 5 × 10 <sup>6</sup> (2W to 3GHz, impedance 50Ω, V.S.W.R.; max. 1.2) (at 20 cpm)			
	Indicator (with indicator type only)		5 VDC, 10 mA, Min. 10 <sup>6</sup> (at 20 cpm)			
Conditions	Conditions for operation, transport and storage*2		Ambient temperature: -55°C to +85°C -67°F to +185°F Humidity: 5 to 85% R.H. (Not freezing and condensing at low temperature)			
Unit weight			Approx. 320g 11.29oz			

Notes: \*1 Factors such as heating of the connected connector influence the high frequency characteristics; therefore, please verify under actual conditions of use.

\*2 The upper operation ambient temperature limit is the maximum temperature that can satisfy the coil temperature rise value. Refer to [6] AMBIENT ENVIRONMENT in GENERAL APPLICATION GUIDELINES.

## REFERENCE DATA

### 1-(1). High frequency characteristics (SPDT) 6GHz type

Sample: ARD70012

Measuring method: Measured with Agilent Technologies network analyzer (E8363B).

#### • V.S.W.R.

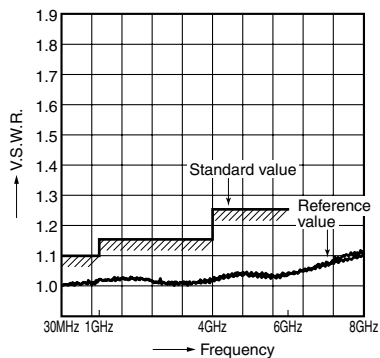

#### • Insertion loss

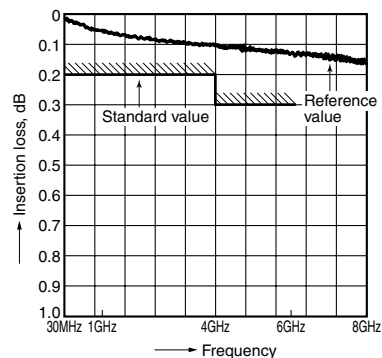

#### • Isolation

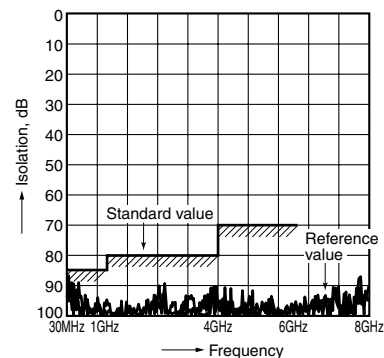

### 1-(2). High frequency characteristics (SPDT) 18, 26.5GHz type

Sample: ARD10012

Measuring method: Measured with Agilent Technologies network analyzer (HP8510).

#### • V.S.W.R.

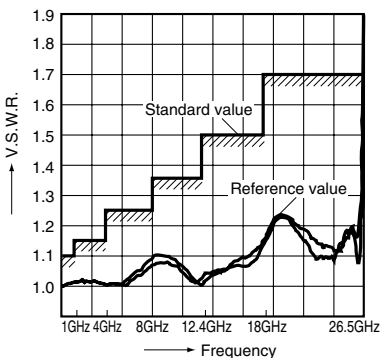

#### • Insertion loss

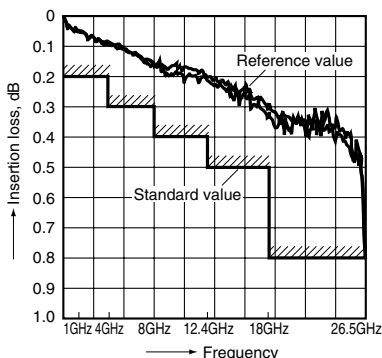

#### • Isolation

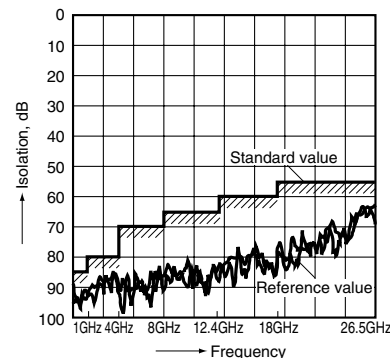

### 1-(3). High frequency characteristics (Transfer)

Sample: ARD60012

Measuring method: Measured with Agilent Technologies network analyzer (HP8510).

#### • V.S.W.R.

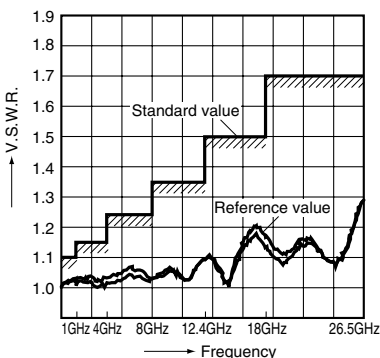

#### • Insertion loss

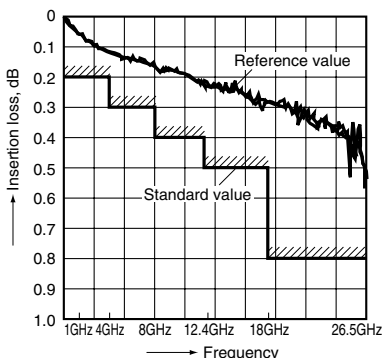

#### • Isolation

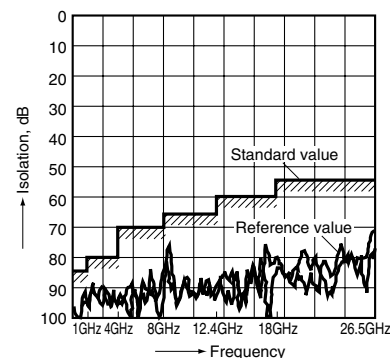

# RD (ARD)

## 1-(4). High frequency characteristics (SP6T)

Sample: ARD30012

Measuring method: Measured with Agilent Technologies network analyzer (HP8510).

### • V.S.W.R.

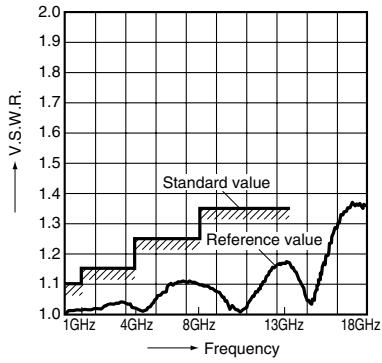

### • Insertion loss

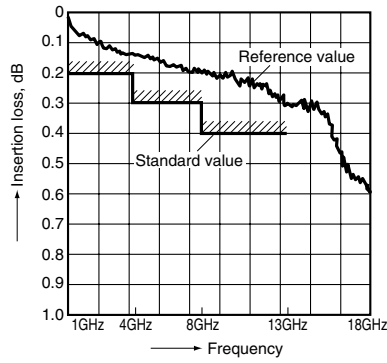

### • Isolation

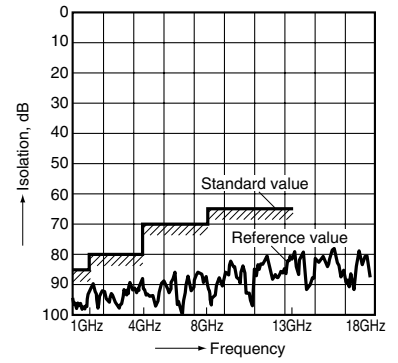

### • Termination characteristics

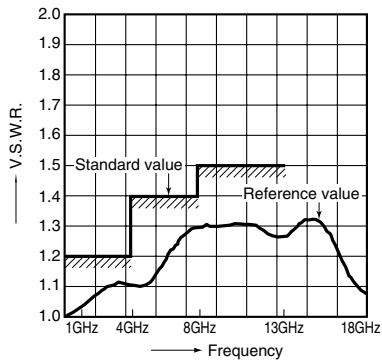



**DIMENSIONS** (mm inch)

The CAD data of the products with a **CAD Data** mark can be downloaded from: <http://panasonic-electric-works.net/ac>

**1. SPDT**

1) Solder terminal

**CAD Data**



6GHz type



18 and 26.5GHz types

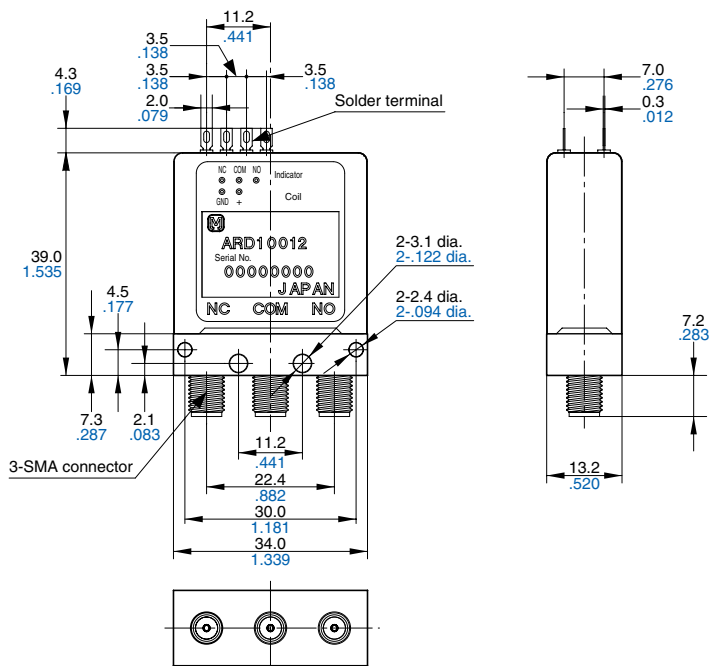

Tolerance:  $\pm 0.3 \pm 0.012$

**Fail-safe**

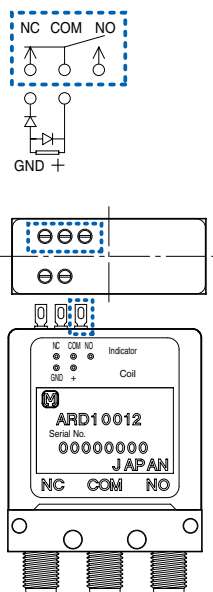

**Latching**

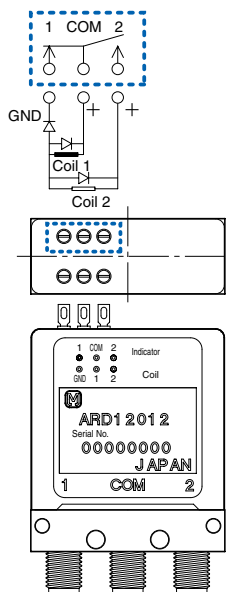

**Latching with TTL driver (with self cut-off function)**

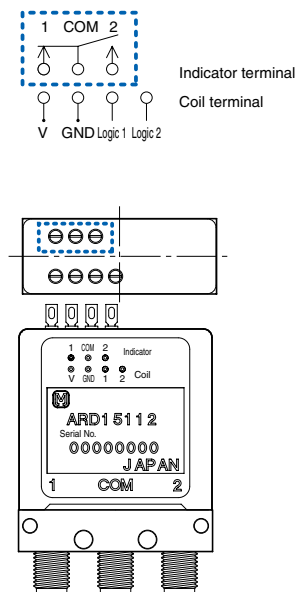

\* + COM type is available

\* The type without indicator terminals will not have the indicator terminals that are marked with the dotted box.

# RD (ARD)

## 2) Connector cable

### CAD Data



Pin No.	Indicator					Coil			
	1	2	3	4	5	6	7	8	9
Fail-safe	-	NC	COM	NO	-	-	GND	+	-
Latching	-	1	COM	2	-	-	GND	1	2
Latching with TTL driver	-	1	COM	2	-	V	GND	Logic 1	Logic 2

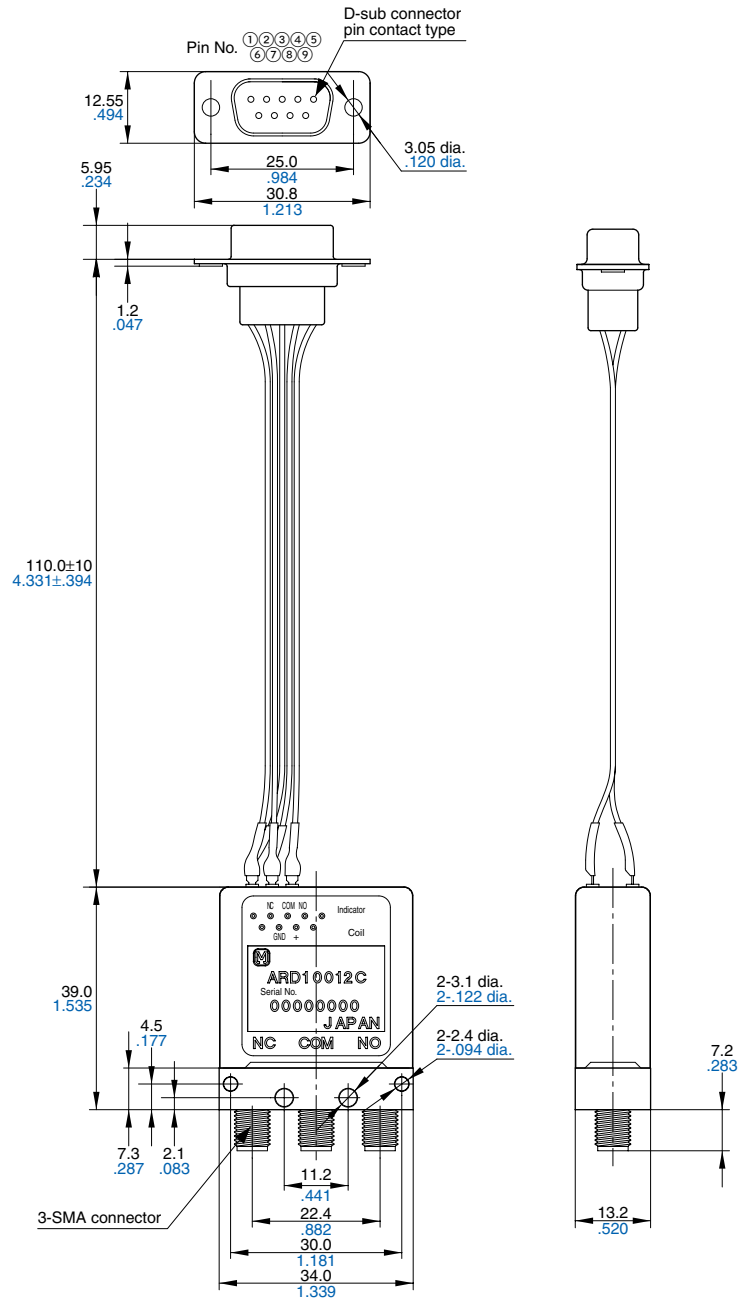

Tolerance:  $\pm 0.3 \pm 0.12$

Fail-safe

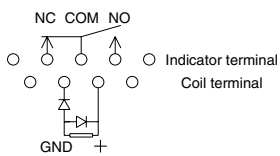

Latching

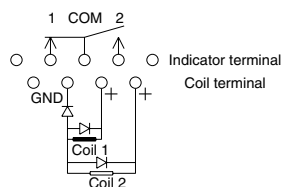

Latching with TTL driver  
(with self cut-off function)

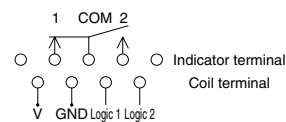

\* + COM type is available

2. Transfer

CAD Data

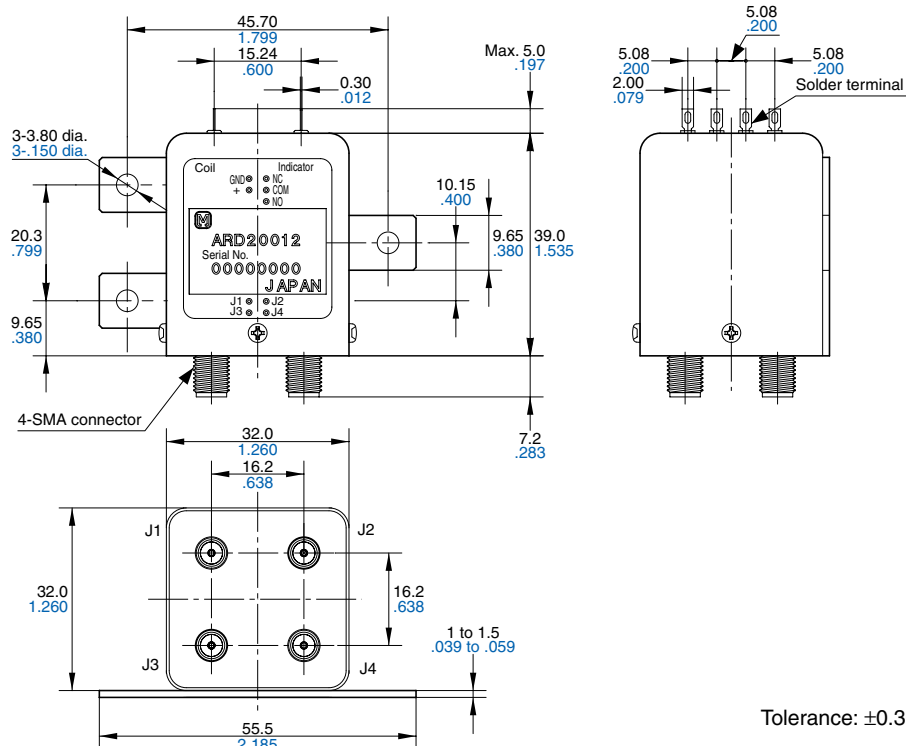

Tolerance:  $\pm 0.3 \pm 0.012$

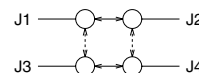

Fail-safe	NC: J1-J2, J3-J4 NO: J1-J3, J2-J4
Latching	POS1: J1-J2, J3-J4 POS2: J1-J3, J2-J4
Latching with TTL driver	POS1: J1-J2, J3-J4 POS2: J1-J3, J2-J4

Fail-safe

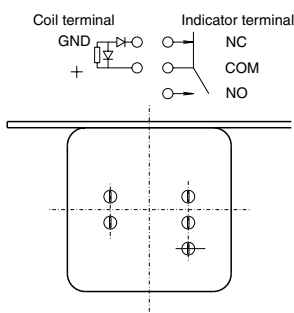

Latching

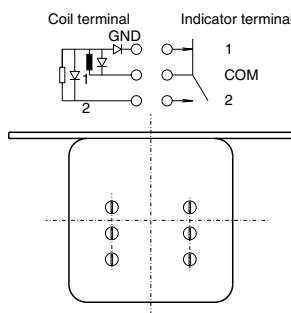

Latching with TTL driver  
(with self cut-off function)

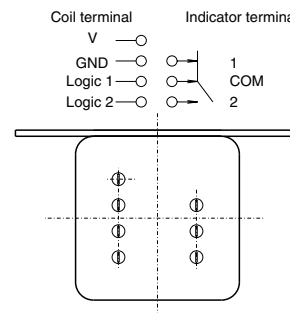

\* + COM type is available

# RD (ARD)

## 3. SP6T

### CAD Data

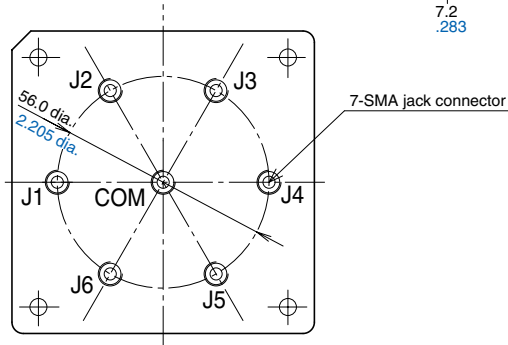
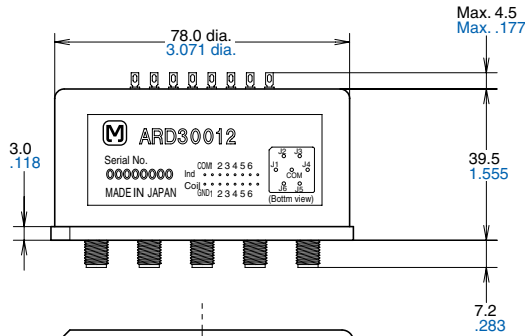
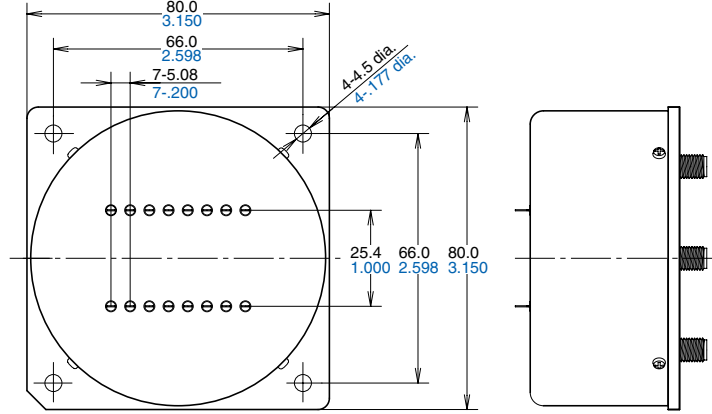
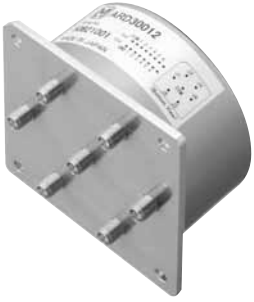

Tolerance:  $\pm 0.3 \pm 0.12$

### Fail-safe type

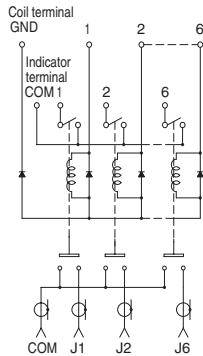

Indicator terminal  
Coil terminal

COM 1 2 3 4 5 6  
.....  
.....  
GND 1 2 3 4 5 6



### Latching type

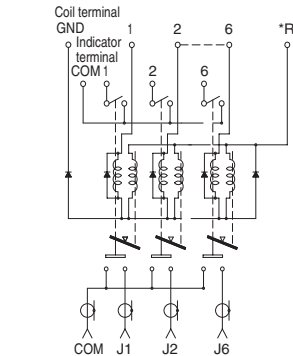

\*RESET (ALL)  
Indicator terminal  
Coil terminal

COM 1 2 3 4 5 6  
.....  
.....  
GND 1 2 3 4 5 6 R



\* + COM type is available.

4. SP6T (with termination)

CAD Data

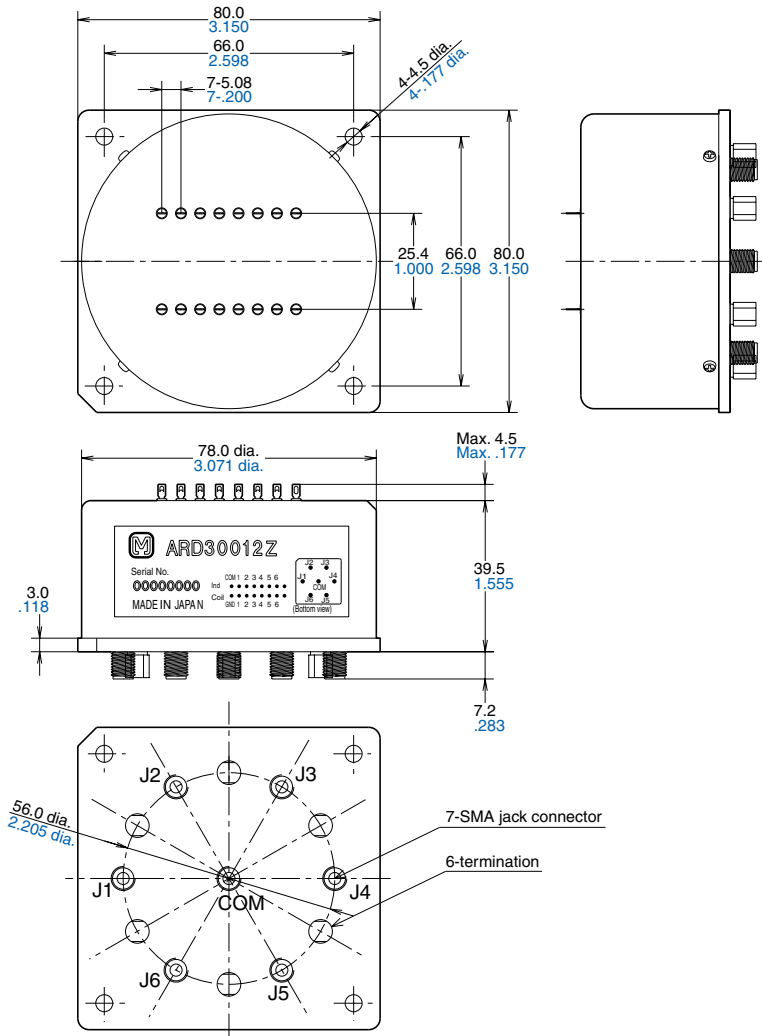

Tolerance:  $\pm 0.3 \pm .012$

Fail-safe type

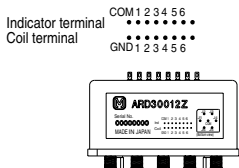
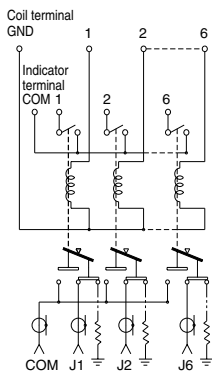

Latching type

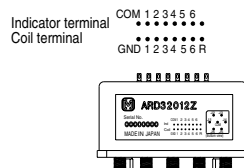
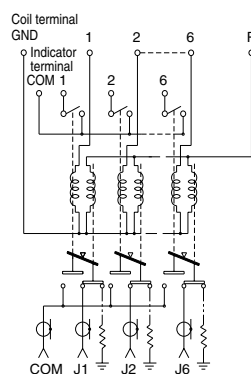

# RD (ARD)

## NOTES

1. For general cautions for use, please refer to the “General Application Guidelines”.

### 2. Coil operating power

Pure DC current should be applied to the coil. The wave form should be rectangular. If it includes ripple, the ripple factor should be less than 5%.

However, check it with the actual circuit since the characteristics may be slightly different. The nominal operating voltage should be applied to the coil for more than 50 ms to set/reset the latching type relay.

Please use the latching type for circuits that are continually powered for long periods of time.

### 3. Coil connection

When connecting coils, refer to the wiring diagram to prevent mis-operation or malfunction.

### 4. Connection of coil indicator and washing conditions

1) The connection of coil indicator terminal shall be done by soldering.

Soldering conditions

Max. 260°C 500°F (solder temp) within 10sec (soldering time)

Max. 350°C 662°F (solder temp) within 3sec (soldering time)

2) This product is not sealed type, therefore washing is not allowed.

### 5. Conditions for operation, transport and storage conditions

1) Temperature:

-55 to +85°C -67 to +185°F

2) Humidity: 5 to 85% RH

(Avoid freezing and condensation.)

The humidity range varies with the temperature. Use within the range indicated in the graph below.

3) Atmospheric pressure: 86 to 106 kPa

Temperature and humidity range for usage, transport, and storage:

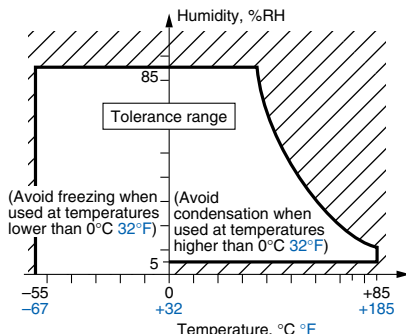

### 4) Condensation

Condensation forms when there is a sudden change in temperature under high temperature and high humidity conditions. Condensation will cause deterioration of the relay insulation.

### 5) Freezing

Condensation or other moisture may freeze on the relay when the temperature is lower than 0°C 32°F. This causes problems such as sticking of movable parts or operational time lags.

### 6) Low temperature, low humidity environments.

The plastic may become brittle if the relay is exposed to a low temperature, low humidity environment for long periods of time.

### 6. Other handling precautions.

1) The relay's on/off service life is based on standard test conditions (temperature: 15 to 35°C 59 to 95°F, humidity: 25 to 75%) specified in JIS C5442-1996. Life will depend on many factors of your system: coil drive circuit, type of load, switching intervals, switching phase, ambient conditions, to name a few.

2) Use the relay within specifications such as coil rating, contact rating and on/off service life. If used beyond limits, the relay may overheat, generate smoke or catch fire.

3) Be careful not to drop the relay. If accidentally dropped, carefully check its appearance and characteristics before use.

4) Be careful to wire the relay correctly. Otherwise, malfunction, overheat, fire or other trouble may occur.

5) The latching type relay is shipped in the reset position. But jolts during transport or impacts during installation can move it to the set position. It is, therefore, advisable to build a circuit in which the relay can be initialized (set and reset) just after turning on the power.

6) If a relay stays on in a circuit for many months or years at a time without being activated, circuit design should be reviewed so that the relay can remain non-excited. A coil that receives current all the time heats, which degrades insulation earlier than expected. A latching type relay is recommended for such circuits.

7) For SMA connectors, we recommend a torque of 0.90±0.1 N·m for installation, which falls within the prescribed torque of MIL-C-39012. Please be aware that conditions might be different depending on the connector materials and how it interacts with surrounding materials.

8) Please do not use silicon based substances such as silicon rubber, silicon oil, silicon coatings and silicon fillings, in the vicinity of the relay. Doing so may cause volatile silicon gas to form which may lead to contact failure due to the adherence of silicon on the contacts when they open and close in this atmosphere.

9) Please note that when switching contacts (latching type only), you must apply reset (ALL) voltage and release all contacts first. (SP6T type)

10) Do not use multiple contacts simultaneously. (SP6T type)

11) The indicator terminal is the terminal that indicates the operation status of the MAIN contact.

12) For details about the drive method of the latching with TTL driver type, please refer to the RD coaxial switch catalog on the website.

Компания «Океан Электроники» предлагает заключение долгосрочных отношений при поставках импортных электронных компонентов на взаимовыгодных условиях!

Наши преимущества:

- Поставка оригинальных импортных электронных компонентов напрямую с производств Америки, Европы и Азии, а так же с крупнейших складов мира;
- Широкая линейка поставок активных и пассивных импортных электронных компонентов (более 30 млн. наименований);
- Поставка сложных, дефицитных, либо снятых с производства позиций;
- Оперативные сроки поставки под заказ (от 5 рабочих дней);
- Экспресс доставка в любую точку России;
- Помощь Конструкторского Отдела и консультации квалифицированных инженеров;
- Техническая поддержка проекта, помощь в подборе аналогов, поставка прототипов;
- Поставка электронных компонентов под контролем ВП;
- Система менеджмента качества сертифицирована по Международному стандарту ISO 9001;
- При необходимости вся продукция военного и аэрокосмического назначения проходит испытания и сертификацию в лаборатории (по согласованию с заказчиком);
- Поставка специализированных компонентов военного и аэрокосмического уровня качества (Xilinx, Altera, Analog Devices, Intersil, Interpoint, Microsemi, Actel, Aeroflex, Peregrine, VPT, Syfer, Eurofarad, Texas Instruments, MS Kennedy, Miteq, Cobham, E2V, MA-COM, Hittite, Mini-Circuits, General Dynamics и др.);

Компания «Океан Электроники» является официальным дистрибьютором и эксклюзивным представителем в России одного из крупнейших производителей разъемов военного и аэрокосмического назначения «JONHON», а так же официальным дистрибьютором и эксклюзивным представителем в России производителя высокотехнологичных и надежных решений для передачи СВЧ сигналов «FORSTAR».



## JONHON

«JONHON» (основан в 1970 г.)

Разъемы специального, военного и аэрокосмического назначения:

(Применяются в военной, авиационной, аэрокосмической, морской, железнодорожной, горно- и нефтедобывающей отраслях промышленности)

«FORSTAR» (основан в 1998 г.)

ВЧ соединители, коаксиальные кабели, кабельные сборки и микроволновые компоненты:

(Применяются в телекоммуникациях гражданского и специального назначения, в средствах связи, РЛС, а так же военной, авиационной и аэрокосмической отраслях промышленности).



Телефон: 8 (812) 309-75-97 (многоканальный)

Факс: 8 (812) 320-03-32

Электронная почта: [ocean@oceanchips.ru](mailto:ocean@oceanchips.ru)

Web: <http://oceanchips.ru/>

Адрес: 198099, г. Санкт-Петербург, ул. Калинина, д. 2, корп. 4, лит. А