

Compliance with RoHS Directive

FEATURES

- 1. Excellent high frequency characteristics (50Ω, to 26.5GHz)**
- 2. SPDT, Transfer and SP6T types are available.**
- 3. High sensitivity**
Nominal operating power:
840 mW (SPDT/SP6T, Fail-safe type, with indicator)
1,540 mW (Transfer, Fail-safe type, with indicator)
*Without 24V type
- 4. Long-lasting life: min. 5 × 10⁶**
- 5. With termination type is added. (SP6T)**
Thanks to the addition of termination, steady high frequency characteristics can be maintained when contacts are either open or closed and this contributes to increase system reliability.

6. + COM type is available.

TYPICAL APPLICATIONS

- Wireless and mobile communication**
 - Cellular phone base station
 - Amplifier switching
- Digital broadcasting**
 - Broadcasting relay station
 - Broadcasting equipment
- Measuring instrument**
- All types of inspection equipment**

Please inquire beforehand if you are thinking of using this product in applications that involve low level load or high frequency of switching.

HIGH FREQUENCY CHARACTERISTICS (Impedance 50Ω)

| Frequency | to 1 GHz | 1 to 4 GHz | 4 to 8 GHz*1 | 8 to 12.4 GHz | 12.4 to 18 GHz | 18 to 26.5 GHz*2 |
|---|----------|------------|--------------|---------------|----------------|------------------|
| V.S.W.R. (max.) | 1.1 | 1.15 | 1.25 | 1.35 | 1.5 | 1.7 |
| V.S.W.R. (SP6T With termination) (max.) | 1.20 | | 1.40 | 1.50 | — | — |
| Insertion loss (dB. max.) | 0.2 | | 0.3 | 0.4 | 0.5 | 0.8 |
| Isolation (dB. min.) | 85 | 80 | 70 | 65 | 60 | 55 |

Notes: *1 The 6GHz type only has the above characteristics up to 6GHz.
*2 18 to 26.5GHz characteristics can be applied 26.5GHz type only (SPDT, Transfer)

ORDERING INFORMATION

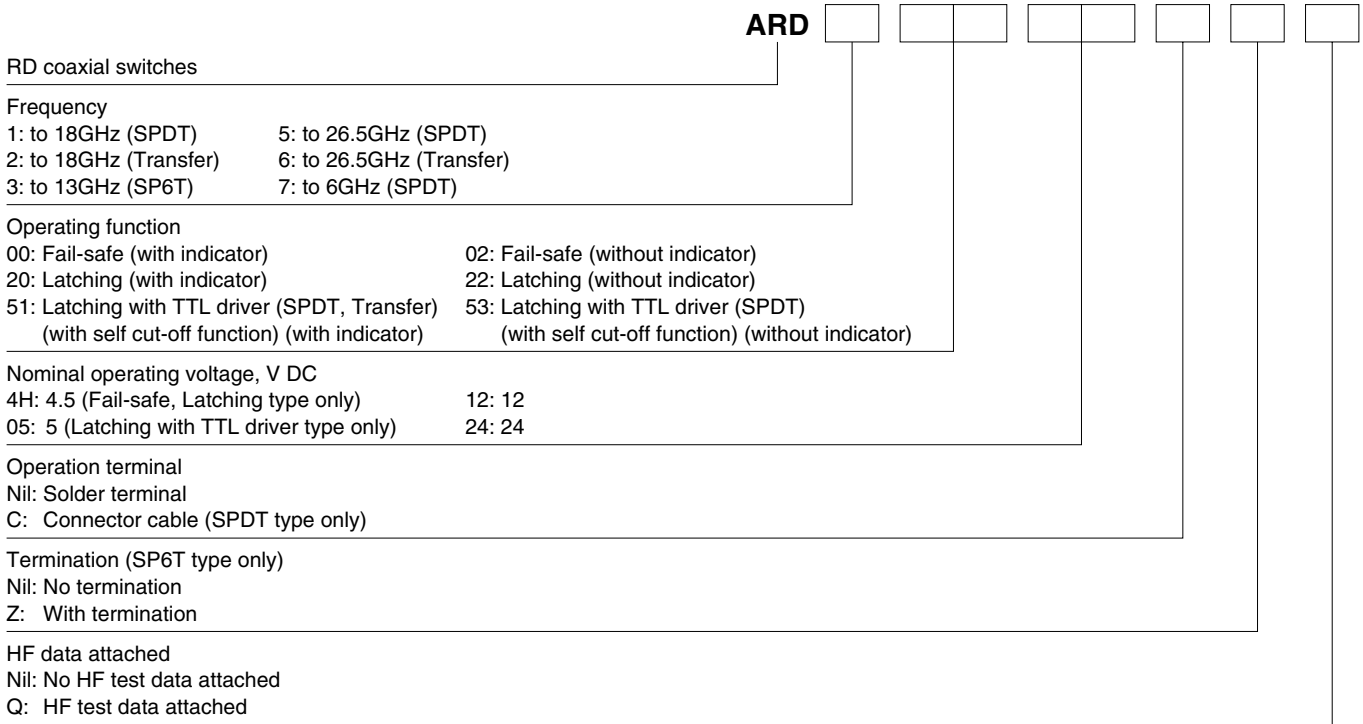

RD (ARD)

TYPES

1. SPDT

1) Solder terminal

| Operating function | Nominal operating voltage, V DC | New 6GHz type | 18GHz type | | 26.5GHz type | |
|---|---------------------------------|--------------------------|--------------------------|-----------------------|--------------------------|-----------------------|
| | | No HF datasheet attached | No HF datasheet attached | HF datasheet attached | No HF datasheet attached | HF datasheet attached |
| Fail-safe (with indicator) | 4.5 | ARD7004H | ARD1004H | ARD1004HQ | ARD5004H | ARD5004HQ |
| | 12 | ARD70012 | ARD10012 | ARD10012Q | ARD50012 | ARD50012Q |
| | 24 | ARD70024 | ARD10024 | ARD10024Q | ARD50024 | ARD50024Q |
| Latching (with indicator) | 4.5 | ARD7204H | ARD1204H | ARD1204HQ | ARD5204H | ARD5204HQ |
| | 12 | ARD72012 | ARD12012 | ARD12012Q | ARD52012 | ARD52012Q |
| | 24 | ARD72024 | ARD12024 | ARD12024Q | ARD52024 | ARD52024Q |
| Latching with TTL driver (with self cut-off function) (with indicator) | 5 | ARD75105 | ARD15105 | ARD15105Q | ARD55105 | ARD55105Q |
| | 12 | ARD75112 | ARD15112 | ARD15112Q | ARD55112 | ARD55112Q |
| | 24 | ARD75124 | ARD15124 | ARD15124Q | ARD55124 | ARD55124Q |
| Fail-safe (without indicator) | 4.5 | ARD7024H | — | — | — | — |
| | 12 | ARD70212 | | | | |
| | 24 | ARD70224 | | | | |
| Latching (without indicator) | 4.5 | ARD7224H | — | — | — | — |
| | 12 | ARD72212 | | | | |
| | 24 | ARD72224 | | | | |
| Latching with TTL driver (with self cut-off function) (without indicator) | 5 | ARD75305 | — | — | — | — |
| | 12 | ARD75312 | | | | |
| | 24 | ARD75324 | | | | |

Note: Standard packing; Carton: 1 pc. Case: 20 pcs.

2) Connector cable

| Operating function | Nominal operating voltage, V DC | 18GHz type | | 26.5GHz type | |
|---|---------------------------------|--------------------------|-----------------------|--------------------------|-----------------------|
| | | No HF datasheet attached | HF datasheet attached | No HF datasheet attached | HF datasheet attached |
| Fail-safe | 4.5 | ARD1004HC | ARD1004HCQ | ARD5004HC | ARD5004HCQ |
| | 12 | ARD10012C | ARD10012CQ | ARD50012C | ARD50012CQ |
| | 24 | ARD10024C | ARD10024CQ | ARD50024C | ARD50024CQ |
| Latching | 4.5 | ARD1204HC | ARD1204HCQ | ARD5204HC | ARD5204HCQ |
| | 12 | ARD12012C | ARD12012CQ | ARD52012C | ARD52012CQ |
| | 24 | ARD12024C | ARD12024CQ | ARD52024C | ARD52024CQ |
| Latching with TTL driver (with self cut-off function) | 5 | ARD15105C | ARD15105CQ | ARD55105C | ARD55105CQ |
| | 12 | ARD15112C | ARD15112CQ | ARD55112C | ARD55112CQ |
| | 24 | ARD15124C | ARD15124CQ | ARD55124C | ARD55124CQ |

Note: Standard packing; Carton: 1 pc. Case: 10 pcs.

2. Transfer

| Operating function | Nominal operating voltage, V DC | 18GHz type | | 26.5GHz type | |
|---|---------------------------------|--------------------------|-----------------------|--------------------------|-----------------------|
| | | No HF datasheet attached | HF datasheet attached | No HF datasheet attached | HF datasheet attached |
| Fail-safe | 4.5 | ARD2004H | ARD2004HQ | ARD6004H | ARD6004HQ |
| | 12 | ARD20012 | ARD20012Q | ARD60012 | ARD60012Q |
| | 24 | ARD20024 | ARD20024Q | ARD60024 | ARD60024Q |
| Latching | 4.5 | ARD2204H | ARD2204HQ | ARD6204H | ARD6204HQ |
| | 12 | ARD22012 | ARD22012Q | ARD62012 | ARD62012Q |
| | 24 | ARD22024 | ARD22024Q | ARD62024 | ARD62024Q |
| Latching with TTL driver (with self cut-off function) | 5 | ARD25105 | ARD25105Q | ARD65105 | ARD65105Q |
| | 12 | ARD25112 | ARD25112Q | ARD65112 | ARD65112Q |
| | 24 | ARD25124 | ARD25124Q | ARD65124 | ARD65124Q |

Note: Standard packing; Carton: 1 pc. Case: 10 pcs.

3. SP6T

| Operating function | Nominal operating voltage, V DC | 13GHz type | |
|--------------------|---------------------------------|--------------------------|-----------------------|
| | | No HF datasheet attached | HF datasheet attached |
| Fail-safe | 4.5 | ARD3004H | ARD3004HQ |
| | 12 | ARD30012 | ARD30012Q |
| | 24 | ARD30024 | ARD30024Q |
| Latching | 4.5 | ARD3204H | ARD3204HQ |
| | 12 | ARD32012 | ARD32012Q |
| | 24 | ARD32024 | ARD32024Q |

Note: Standard packing; Carton: 1 pc. Case: 5 pcs.

4. SP6T (with termination)

| Operating function | Nominal operating voltage, V DC | 13GHz type | |
|--------------------|---------------------------------|--------------------------|-----------------------|
| | | No HF datasheet attached | HF datasheet attached |
| Fail-safe | 4.5 | ARD3004HZ | ARD3004HZQ |
| | 12 | ARD30012Z | ARD30012ZQ |
| | 24 | ARD30024Z | ARD30024ZQ |
| Latching | 4.5 | ARD3204HZ | ARD3204HZQ |
| | 12 | ARD32012Z | ARD32012ZQ |
| | 24 | ARD32024Z | ARD32024ZQ |

Note: Standard packing; Carton: 1 pc. Case: 5 pcs.

RATING**1. Coil data****(1) SPDT****1) Fail-safe type**

| Nominal operating voltage, V DC | Nominal operating current, mA (+10%/–15%) (at 20°C 68°F) | | Nominal power consumption, mW | |
|---------------------------------|--|-------------------|-------------------------------|-------------------|
| | With indicator | Without indicator | With indicator | Without indicator |
| 4.5 | 186.7 | 155.6 | 840 | 700 |
| 12 | 70.0 | 58.3 | | |
| 24 | 40.4 | 29.2 | 970 | |

2) Latching type

| Nominal operating voltage, V DC | Nominal operating current, mA (+10%/–15%) (at 20°C 68°F) | | Nominal power consumption, mW | |
|---------------------------------|--|-------------------|-------------------------------|-------------------|
| | With indicator | Without indicator | With indicator | Without indicator |
| 4.5 | 155.6 | 111.1 | 700 | 500 |
| 12 | 62.5 | 41.7 | 750 | |
| 24 | 37.5 | 16.7 | 900 | |

3) Latching with TTL driver type

| Nominal operating voltage, V DC | TTL logic level (see TTL logic level range) | | Electronic self cut-off | Switching frequency |
|---------------------------------|---|-----------|-------------------------|--|
| | ON | OFF | | |
| 5 | 2.4 to 5.5V | 0 to 0.5V | Available | Max. 180 cpm (ON time : OFF time = 1 : 1) |
| 12 | | | | |
| 24 | | | | |

(2) Transfer**1) Fail-safe type**

| Nominal operating voltage, V DC | Nominal operating current, mA (+10%/–15%) (at 20°C 68°F) | Nominal power consumption, mW |
|---------------------------------|--|-------------------------------|
| 4.5 | 342.2 | 1540 |
| 12 | 128.3 | |
| 24 | 69.6 | 1670 |

2) Latching type

| Nominal operating voltage, V DC | Nominal operating current, mA (+10%/–15%) (at 20°C 68°F) | Nominal power consumption, mW |
|---------------------------------|--|-------------------------------|
| 4.5 | 266.7 | 1200 |
| 12 | 104.2 | 1250 |
| 24 | 58.3 | 1400 |

3) Latching with TTL driver type (with self cut-off function)

| Nominal operating voltage, V DC | TTL logic level (see TTL logic level range) | | Electronic self cut-off | Switching frequency |
|---------------------------------|---|-----------|-------------------------|--|
| | ON | OFF | | |
| 5 | 2.4 to 5.5V | 0 to 0.5V | Available | Max. 180 cpm (ON time : OFF time = 1 : 1) |
| 12 | | | | |
| 24 | | | | |

(3) SP6T and SP6T (with termination type)**1) Fail-safe type**

| Nominal operating voltage, V DC | Nominal operating current, mA (+10%/–15%) (at 20°C 68°F) | Nominal power consumption, mW |
|---------------------------------|--|-------------------------------|
| 4.5 | 186.7 | 840 |
| 12 | 70.0 | |
| 24 | 40.4 | 970 |

2) Latching type

| Nominal operating voltage, V DC | Nominal operating current, mA (+10%/–15%) (at 20°C 68°F) | Nominal power consumption, mW |
|---------------------------------|--|-------------------------------|
| 4.5 | SET: 155.6 / RESET (ALL): 933.6 | SET: 700 / RESET (ALL): 4,200 |
| 12 | SET: 62.5 / RESET (ALL): 375.0 | SET: 750 / RESET (ALL): 4,500 |
| 24 | SET: 37.5 / RESET (ALL): 225.0 | SET: 900 / RESET (ALL): 5,400 |

RD (ARD)

• Operating voltage range

1) Fail-safe type



2) Latching type



3) Latching with TTL driver type (with self cut-off function)

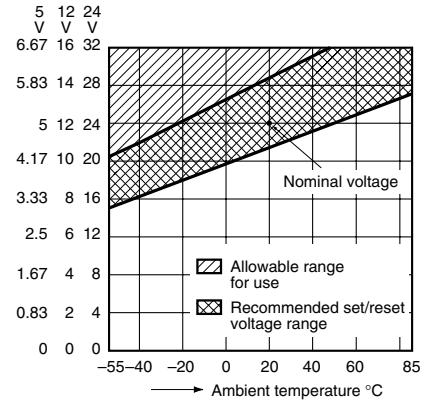

4) TTL Logic level range



Note: Please consult us for use that is outside this range.

2. Specifications

1) SPDT/Transfer

| Characteristics | Item | Specifications | | | | | |
|--|---|---|---|---------------------|--|--|------------------|
| | | SPDT | | | Transfer | | |
| Contact | Arrangement | SPDT | | | Transfer | | |
| | Contact material | Gold plating | | | | | |
| | Initial contact resistance | Max. 100mΩ (By voltage drop 6V DC 1A) | | | | | |
| Rating | Contact input power | 120W (at 3GHz) (V.S.W.R. 1.15 or less, no contact switching, ambient temperature 40°C 104°F [SPDT], 25°C 77°F [Transfer])*1 | | | | | |
| | Nominal operating power | Fail-safe | 840mW (4.5V, 12V DC), 970mW (24V DC) | | | 1,540mW (4.5V, 12V DC), 1,670mW (24V DC) | |
| | | Latching | 700mW (4.5V DC), 750mW (12V DC), 900mW (24V DC) | | | 1,200mW (4.5V DC), 1,250mW (12V DC), 1,400mW (24V DC) | |
| Indicator rating (with indicator type only) | Contact rating | Max. 30V 100mA | | | | | |
| | Initial contact resistance | Max. 1Ω (Measured by 5V 100mA) | | | | | |
| | Min. switching capacity (Reference value) | 3V DC, 0.1mA (5 × 10 ⁶ , Reliability level: 10% (3kΩ)) | | | | | |
| High frequency characteristics (Impedance 50Ω) | | to 1 GHz | 1 to 4 GHz | 4 to 8 GHz*2 | 8 to 12.4 GHz | 12.4 to 18 GHz | 18 to 26.5 GHz*3 |
| | V.S.W.R. (max.) | 1.1 | 1.15 | 1.25 | 1.35 | 1.5 | 1.7 |
| | Insertion loss (dB, max.) | 0.2 | | 0.3 | 0.4 | 0.5 | 0.8 |
| | Isolation (dB, min.) | 85 | 80 | 70 | 65 | 60 | 55 |
| Electrical characteristics | Insulation resistance (Initial) | | Min. 1,000 MΩ (at 500 V DC) Measurement at same location as "breakdown voltage (Initial)" section. | | | | |
| | Breakdown voltage (Initial) | Between open contacts | 500 Vrms for 1 min. (Detection current: 10mA) | | | | |
| | | Between contact and coil | 500 Vrms for 1 min. (Detection current: 10mA) | | | | |
| | | Between contact and earth terminal | 500 Vrms for 1 min. (Detection current: 10mA) | | | | |
| | | Between coil and earth terminal | 500 Vrms for 1 min. (Detection current: 10mA) | | | | |
| Time characteristics (at 20°C 68°F) | Operate time | | Max. 15ms (Nominal operating voltage applied to the coil, excluding contact bounce time.) | | Max. 20ms (Nominal operating voltage applied to the coil, excluding contact bounce time.) | | |
| Mechanical characteristics | Shock resistance | Functional | Min. 500 m/s ² (Half-wave pulse of sine wave: 11ms, detection time: 10μs.) | | | | |
| | | Destructive | Min. 1,000 m/s ² (Half-wave pulse of sine wave: 11ms.) | | | | |
| | Vibration resistance | Functional | 10 to 55 Hz at double amplitude of 3mm (Detection time: 10μs.) | | | | |
| | | Destructive | 10 to 55 Hz at double amplitude of 5mm | | | | |
| Expected life | Mechanical | | 6GHz type: Min. 10 ⁶ 18 and 26.5GHz type: Min. 5 × 10 ⁶ (All types, at 180 cpm) | | Min. 5 × 10 ⁶ (at 180 cpm) | | |
| | Electrical | High frequency contact (Hot switch) | 6GHz type: Min. 10 ⁶ 18 and 26.5GHz type: Min. 5 × 10 ⁶ (All types, 5W to 3GHz, impedance 50Ω, V.S.W.R.; max. 1.2) (at 20 cpm) | | Min. 5 × 10 ⁶ (5W to 3GHz, impedance 50Ω, V.S.W.R.; max. 1.2) (at 20 cpm) | | |
| | | Indicator (with indicator type only) | 5 V DC, 10 mA, Min. 10 ⁶ (at 20 cpm) | | | | |
| Conditions | Conditions for operation, transport and storage*4 | | Ambient temperature: -55°C to +85°C -67°F to +185°F Humidity: 5 to 85% R.H. (Not freezing and condensing at low temperature) | | | | |
| Unit weight | Approx. 50g 1.76oz | | | Approx. 110g 3.88oz | | | |

Notes: *1 Factors such as heating of the connected connector influence the high frequency characteristics; therefore, please verify under actual conditions of use.

*2 The 6GHz type only has the above characteristics up to 6GHz.

*3 18 to 26.5GHz characteristics can be applied 26.5GHz type only (SPDT, Transfer)

*4 The upper operation ambient temperature limit is the maximum temperature that can satisfy the coil temperature rise value. Refer to [6] AMBIENT ENVIRONMENT in GENERAL APPLICATION GUIDELINES.

RD (ARD)

2) SP6T

| Characteristics | Item | | Specifications | | | |
|--|---|-------------------------------------|---|--|------------|-------------|
| Contact | Arrangement | | SP6T | | | |
| | Contact material | | Gold plating | | | |
| | Initial contact resistance | | Max. 100mΩ (By voltage drop 6V DC 1A) | | | |
| Rating | Contact input power | No termination | 120 W (at 3GHz) (V.S.W.R. 1.15 or less, no contact switching, ambient temperature 25°C 77°F)*1 | | | |
| | | With termination | 2W (at 3GHz) (V.S.W.R. 1.15 or less, no contact switching, ambient temperature 25°C 77°F)*1 | | | |
| | Nominal operating power | Fail-safe | 840mW (4.5V, 12V DC), 970mW (24V DC) | | | |
| | | Latching | 700mW (4.5V DC), 750mW (12V DC), 900mW (24V DC) | | | |
| Indicator rating | Contact rating | | Max. 30V 100mA | | | |
| | Initial contact resistance | | Max. 1Ω (Measured by 5V 100mA) | | | |
| | Min. switching capacity (Reference value) | | 3V DC, 0.1mA (5 × 10 ⁶ , Reliability level: 10% (3kΩ)) | | | |
| High frequency characteristics (Impedance 50Ω) | | | to 1 GHz | 1 to 4 GHz | 4 to 8 GHz | 8 to 13 GHz |
| | V.S.W.R. (max.) | No termination | 1.1 | 1.15 | 1.25 | 1.35 |
| | | With termination | 1.20 | | 1.40 | 1.50 |
| | Insertion loss (dB, max.) | | 0.2 | | 0.3 | 0.4 |
| | Isolation (dB, min.) | | 85 | 80 | 70 | 65 |
| Electrical characteristics | Insulation resistance (Initial) | | Min. 1,000 MΩ (at 500 V DC) Measurement at same location as "breakdown voltage (Initial)" section. | | | |
| | Breakdown voltage (Initial) | Between open contacts | 500 Vrms for 1 min. (Detection current: 10mA) | | | |
| | | Between contact and coil | 500 Vrms for 1 min. (Detection current: 10mA) | | | |
| | | Between contact and earth terminal | 500 Vrms for 1 min. (Detection current: 10mA) | | | |
| | | Between coil and earth terminal | 500 Vrms for 1 min. (Detection current: 10mA) | | | |
| Time characteristics (at 20°C 68°F) | Operate time | | Max. 20ms (Nominal operating voltage applied to the coil, excluding contact bounce time.) | | | |
| Mechanical characteristics | Shock resistance | Functional | Min. 500 m/s ² (Half-wave pulse of sine wave: 11ms, detection time: 10μs.) | | | |
| | | Destructive | Min. 1,000 m/s ² (Half-wave pulse of sine wave: 11ms.) | | | |
| | Vibration resistance | Functional | 10 to 55 Hz at double amplitude of 3mm (Detection time: 10μs.) | | | |
| | | Destructive | 10 to 55 Hz at double amplitude of 5mm | | | |
| Expected life | Mechanical | | Min. 5 × 10 ⁶ (at 180 cpm) | | | |
| | Electrical | High frequency contact (Hot switch) | No termination | Min. 5 × 10 ⁶ (5W to 3GHz, impedance 50Ω, V.S.W.R.; max. 1.2) (at 20 cpm) | | |
| | | | With termination | Min. 5 × 10 ⁶ (2W to 3GHz, impedance 50Ω, V.S.W.R.; max. 1.2) (at 20 cpm) | | |
| | Indicator (with indicator type only) | | 5 VDC, 10 mA, Min. 10 ⁶ (at 20 cpm) | | | |
| Conditions | Conditions for operation, transport and storage*2 | | Ambient temperature: -55°C to +85°C -67°F to +185°F Humidity: 5 to 85% R.H. (Not freezing and condensing at low temperature) | | | |
| Unit weight | | | Approx. 320g 11.29oz | | | |

Notes: *1 Factors such as heating of the connected connector influence the high frequency characteristics; therefore, please verify under actual conditions of use.

*2 The upper operation ambient temperature limit is the maximum temperature that can satisfy the coil temperature rise value. Refer to [6] AMBIENT ENVIRONMENT in GENERAL APPLICATION GUIDELINES.

REFERENCE DATA

1-(1). High frequency characteristics (SPDT) 6GHz type

Sample: ARD70012

Measuring method: Measured with Agilent Technologies network analyzer (E8363B).

• V.S.W.R.

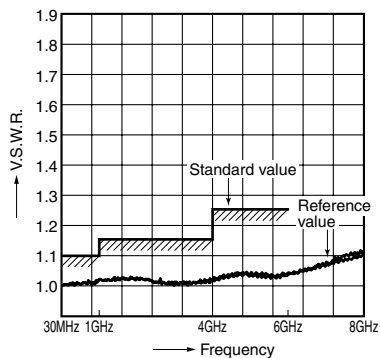

• Insertion loss

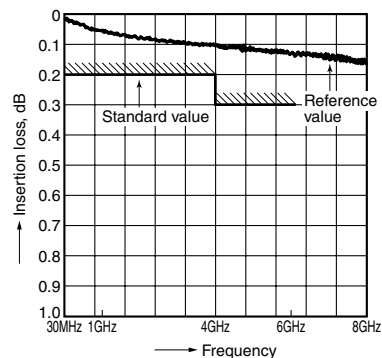

• Isolation



1-(2). High frequency characteristics (SPDT) 18, 26.5GHz type

Sample: ARD10012

Measuring method: Measured with Agilent Technologies network analyzer (HP8510).

• V.S.W.R.



• Insertion loss

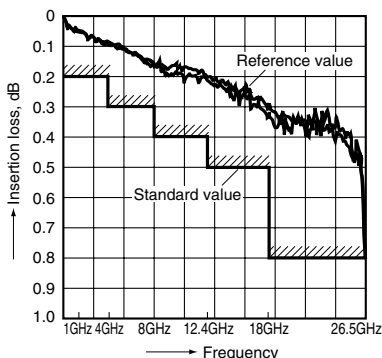

• Isolation



1-(3). High frequency characteristics (Transfer)

Sample: ARD60012

Measuring method: Measured with Agilent Technologies network analyzer (HP8510).

• V.S.W.R.



• Insertion loss

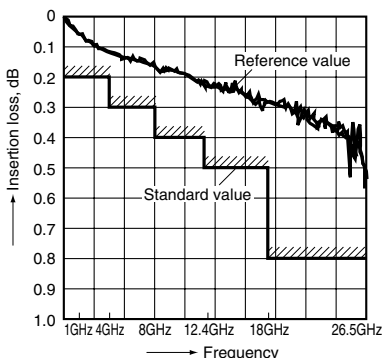

• Isolation



RD (ARD)

1-(4). High frequency characteristics (SP6T)

Sample: ARD30012

Measuring method: Measured with Agilent Technologies network analyzer (HP8510).

• V.S.W.R.



• Insertion loss



• Isolation



• Termination characteristics



DIMENSIONS (mm inch)

The CAD data of the products with a **CAD Data** mark can be downloaded from: <http://panasonic-electric-works.net/ac>

1. SPDT

1) Solder terminal

CAD Data



6GHz type



18 and 26.5GHz types



Tolerance: $\pm 0.3 \pm .012$

Fail-safe



Latching

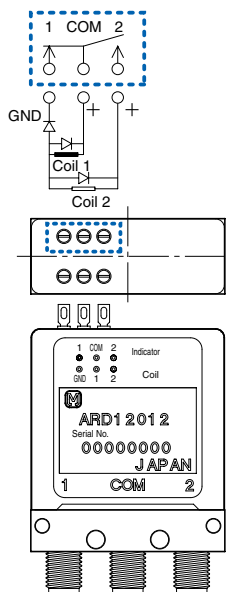

Latching with TTL driver
(with self cut-off function)



* + COM type is available

* The type without indicator terminals will not have the indicator terminals that are marked with the dotted box.

RD (ARD)

2) Connector cable

CAD Data



| Pin No. | Indicator | | | | | Coil | | | |
|--------------------------|-----------|----|-----|----|---|------|-----|---------|---------|
| | 1 | 2 | 3 | 4 | 5 | 6 | 7 | 8 | 9 |
| Fail-safe | - | NC | COM | NO | - | - | GND | + | - |
| Latching | - | 1 | COM | 2 | - | - | GND | 1 | 2 |
| Latching with TTL driver | - | 1 | COM | 2 | - | V | GND | Logic 1 | Logic 2 |

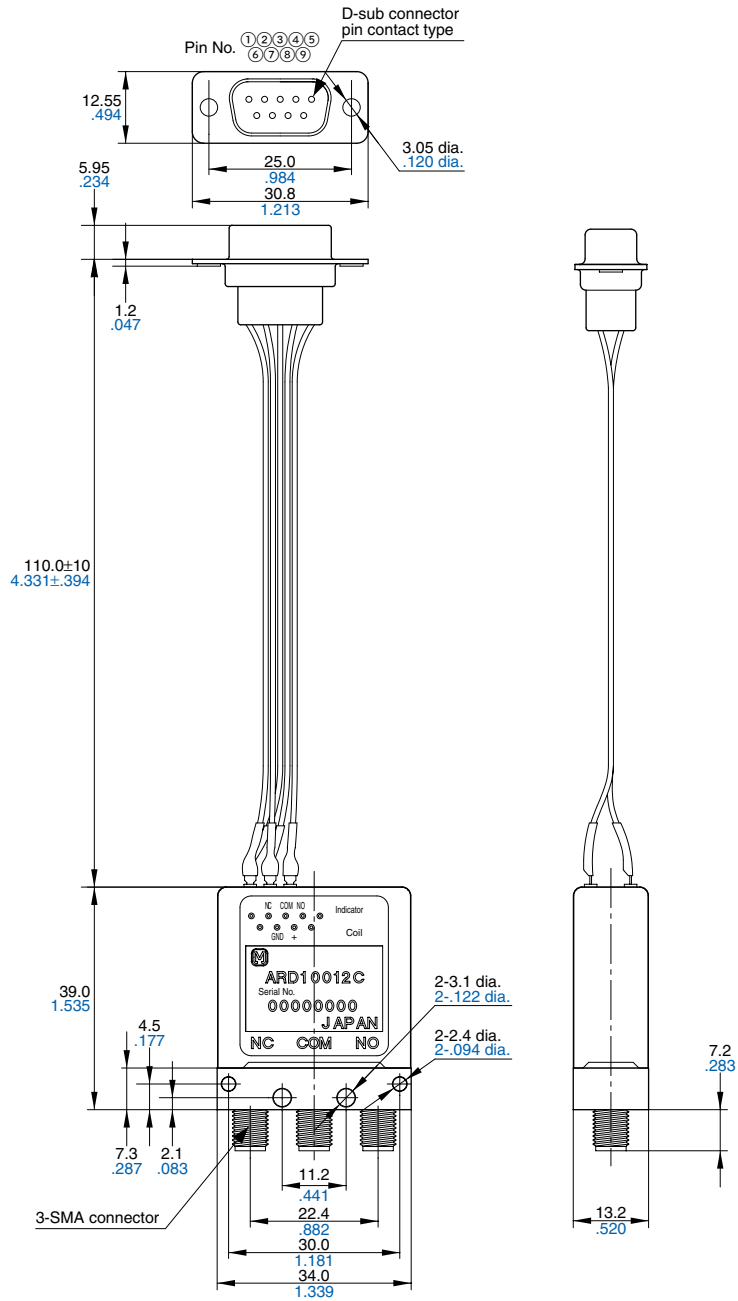

Tolerance: $\pm 0.3 \pm 0.12$

Fail-safe



Latching



Latching with TTL driver
(with self cut-off function)



* + COM type is available

RD (ARD)

3. SP6T

CAD Data



Tolerance: $\pm 0.3 \pm 0.12$

Fail-safe type



Indicator terminal
Coil terminal

| | | | | | |
|-------|---|---|---|---|---|
| COM 1 | 2 | 3 | 4 | 5 | 6 |
| ● | ● | ● | ● | ● | ● |
| ● | ● | ● | ● | ● | ● |
| GND 1 | 2 | 3 | 4 | 5 | 6 |
| ● | ● | ● | ● | ● | ● |



Latching type

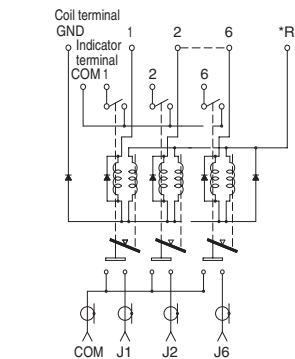

*RESET (ALL)

| | | | | | |
|-------|---|---|---|---|---|
| COM 1 | 2 | 3 | 4 | 5 | 6 |
| ● | ● | ● | ● | ● | ● |
| ● | ● | ● | ● | ● | ● |
| GND 1 | 2 | 3 | 4 | 5 | 6 |
| ● | ● | ● | ● | ● | ● |
| R | | | | | |



* + COM type is available.

4. SP6T (with termination)

CAD Data



Tolerance: $\pm 0.3 \pm .012$

Fail-safe type

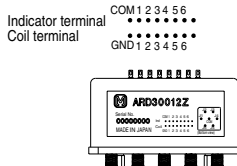
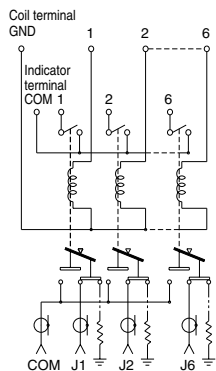

Latching type

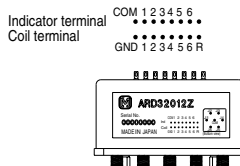

RD (ARD)

NOTES

1. For general cautions for use, please refer to the “General Application Guidelines”.

2. Coil operating power

Pure DC current should be applied to the coil. The wave form should be rectangular. If it includes ripple, the ripple factor should be less than 5%.

However, check it with the actual circuit since the characteristics may be slightly different. The nominal operating voltage should be applied to the coil for more than 50 ms to set/reset the latching type relay.

Please use the latching type for circuits that are continually powered for long periods of time.

3. Coil connection

When connecting coils, refer to the wiring diagram to prevent mis-operation or malfunction.

4. Connection of coil indicator and washing conditions

1) The connection of coil indicator terminal shall be done by soldering.

Soldering conditions

Max. 260°C 500°F (solder temp) within 10sec (soldering time)

Max. 350°C 662°F (solder temp) within 3sec (soldering time)

2) This product is not sealed type, therefore washing is not allowed.

5. Conditions for operation, transport and storage conditions

1) Temperature:

-55 to +85°C -67 to +185°F

2) Humidity: 5 to 85% RH

(Avoid freezing and condensation.)

The humidity range varies with the temperature. Use within the range indicated in the graph below.

3) Atmospheric pressure: 86 to 106 kPa

Temperature and humidity range for usage, transport, and storage:



4) Condensation

Condensation forms when there is a sudden change in temperature under high temperature and high humidity conditions. Condensation will cause deterioration of the relay insulation.

5) Freezing

Condensation or other moisture may freeze on the relay when the temperature is lower than 0°C 32°F. This causes problems such as sticking of movable parts or operational time lags.

6) Low temperature, low humidity environments.

The plastic may become brittle if the relay is exposed to a low temperature, low humidity environment for long periods of time.

6. Other handling precautions.

1) The relay's on/off service life is based on standard test conditions (temperature: 15 to 35°C 59 to 95°F, humidity: 25 to 75%) specified in JIS C5442-1996. Life will depend on many factors of your system: coil drive circuit, type of load, switching intervals, switching phase, ambient conditions, to name a few.

2) Use the relay within specifications such as coil rating, contact rating and on/off service life. If used beyond limits, the relay may overheat, generate smoke or catch fire.

3) Be careful not to drop the relay. If accidentally dropped, carefully check its appearance and characteristics before use.

4) Be careful to wire the relay correctly. Otherwise, malfunction, overheat, fire or other trouble may occur.

5) The latching type relay is shipped in the reset position. But jolts during transport or impacts during installation can move it to the set position. It is, therefore, advisable to build a circuit in which the relay can be initialized (set and reset) just after turning on the power.

6) If a relay stays on in a circuit for many months or years at a time without being activated, circuit design should be reviewed so that the relay can remain non-excited. A coil that receives current all the time heats, which degrades insulation earlier than expected. A latching type relay is recommended for such circuits.

7) For SMA connectors, we recommend a torque of 0.90±0.1 N·m for installation, which falls within the prescribed torque of MIL-C-39012. Please be aware that conditions might be different depending on the connector materials and how it interacts with surrounding materials.

8) Please do not use silicon based substances such as silicon rubber, silicon oil, silicon coatings and silicon fillings, in the vicinity of the relay. Doing so may cause volatile silicon gas to form which may lead to contact failure due to the adherence of silicon on the contacts when they open and close in this atmosphere.

9) Please note that when switching contacts (latching type only), you must apply reset (ALL) voltage and release all contacts first. (SP6T type)

10) Do not use multiple contacts simultaneously. (SP6T type)

11) The indicator terminal is the terminal that indicates the operation status of the MAIN contact.

12) For details about the drive method of the latching with TTL driver type, please refer to the RD coaxial switch catalog on the website.

Компания «Океан Электроники» предлагает заключение долгосрочных отношений при поставках импортных электронных компонентов на взаимовыгодных условиях!

Наши преимущества:

- Поставка оригинальных импортных электронных компонентов напрямую с производств Америки, Европы и Азии, а так же с крупнейших складов мира;
- Широкая линейка поставок активных и пассивных импортных электронных компонентов (более 30 млн. наименований);
- Поставка сложных, дефицитных, либо снятых с производства позиций;
- Оперативные сроки поставки под заказ (от 5 рабочих дней);
- Экспресс доставка в любую точку России;
- Помощь Конструкторского Отдела и консультации квалифицированных инженеров;
- Техническая поддержка проекта, помощь в подборе аналогов, поставка прототипов;
- Поставка электронных компонентов под контролем ВП;
- Система менеджмента качества сертифицирована по Международному стандарту ISO 9001;
- При необходимости вся продукция военного и аэрокосмического назначения проходит испытания и сертификацию в лаборатории (по согласованию с заказчиком);
- Поставка специализированных компонентов военного и аэрокосмического уровня качества (Xilinx, Altera, Analog Devices, Intersil, Interpoint, Microsemi, Actel, Aeroflex, Peregrine, VPT, Syfer, Eurofarad, Texas Instruments, MS Kennedy, Miteq, Cobham, E2V, MA-COM, Hittite, Mini-Circuits, General Dynamics и др.);

Компания «Океан Электроники» является официальным дистрибьютором и эксклюзивным представителем в России одного из крупнейших производителей разъемов военного и аэрокосмического назначения «JONHON», а так же официальным дистрибьютором и эксклюзивным представителем в России производителя высокотехнологичных и надежных решений для передачи СВЧ сигналов «FORSTAR».



JONHON

«JONHON» (основан в 1970 г.)

Разъемы специального, военного и аэрокосмического назначения:

(Применяются в военной, авиационной, аэрокосмической, морской, железнодорожной, горно- и нефтедобывающей отраслях промышленности)

«FORSTAR» (основан в 1998 г.)

ВЧ соединители, коаксиальные кабели, кабельные сборки и микроволновые компоненты:

(Применяются в телекоммуникациях гражданского и специального назначения, в средствах связи, РЛС, а так же военной, авиационной и аэрокосмической отраслях промышленности).



Телефон: 8 (812) 309-75-97 (многоканальный)

Факс: 8 (812) 320-03-32

Электронная почта: ocean@oceanchips.ru

Web: <http://oceanchips.ru/>

Адрес: 198099, г. Санкт-Петербург, ул. Калинина, д. 2, корп. 4, лит. А