

### DESCRIPTION

The MP2633 is a highly-integrated, flexible, switch-mode battery charge management and system power path management device for a single-cell Li-ion and Li-Polymer battery used in a wide range of portable applications.

The MP2633 has two operating modes—charge mode and boost mode—to allow management of system and battery power based on the state of the input.

When input power is present, the device operates in charge mode. It automatically detects the battery voltage and charges the battery in the three phases: trickle current, constant current and constant voltage. Other features include charge termination and auto-recharge. This device also integrates both input-current limit and input-voltage regulation in order to manage input power and meet the priority of the system power demand.

In the absence of an input source, the MP2633 switches to boost mode through the MODE pin to power the SYS pins from the battery. The OLIM pin programs the output current limit in boost mode. The MP2633 also allows an output short-circuit thanks to an output disconnect feature, and can auto-recover when the short circuit fault is removed.

The MP2633 provides full operating status indication to distinguish charge mode from boost mode.

The MP2633 achieves low EMI/EMC performance with well-controlled switching edges.

To guarantee safe operation, the MP2633 limits the die temperature to a preset value 120°C. Other safety features include input over-voltage protection, battery over-voltage protection, thermal shutdown, battery temperature monitoring, and a programmable timer to prevent prolonged charging of a dead battery.

### FEATURES

- 4.5V-to-6V Operating Input Voltage Range
- Power Management Function Integrated Input-Current Limit and Input-Voltage Regulation
- Up to 1.5A Programmable Charge Current
- Trickle-Charge Function
- Selectable 3.6V/ 4.2V Charge Voltage with 0.5% Accuracy
- Negative Temperature Coefficient Pin for Battery Temperature Monitoring
- Programmable Timer Back-Up Protection
- Thermal Regulation and Thermal Shutdown
- Internal Battery Reverse Leakage Blocking
- Reverse Boost Operation Mode for System Power
- Up to 91% 5V Boost Mode Efficiency @ 1A
- Programmable Output Current Limit for Boost Mode
- Integrated Short Circuit Protection for Boost Mode

### APPLICATIONS

- Sub-Battery Applications
- Power-Bank Applications for Smart-Phone Tablet and other Portable Device

All MPS parts are lead-free and adhere to the RoHS directive. For MPS green status, please visit MPS website under Products, Quality Assurance page.

"MPS" and "The Future of Analog IC Technology" are registered trademarks of Monolithic Power Systems, Inc.

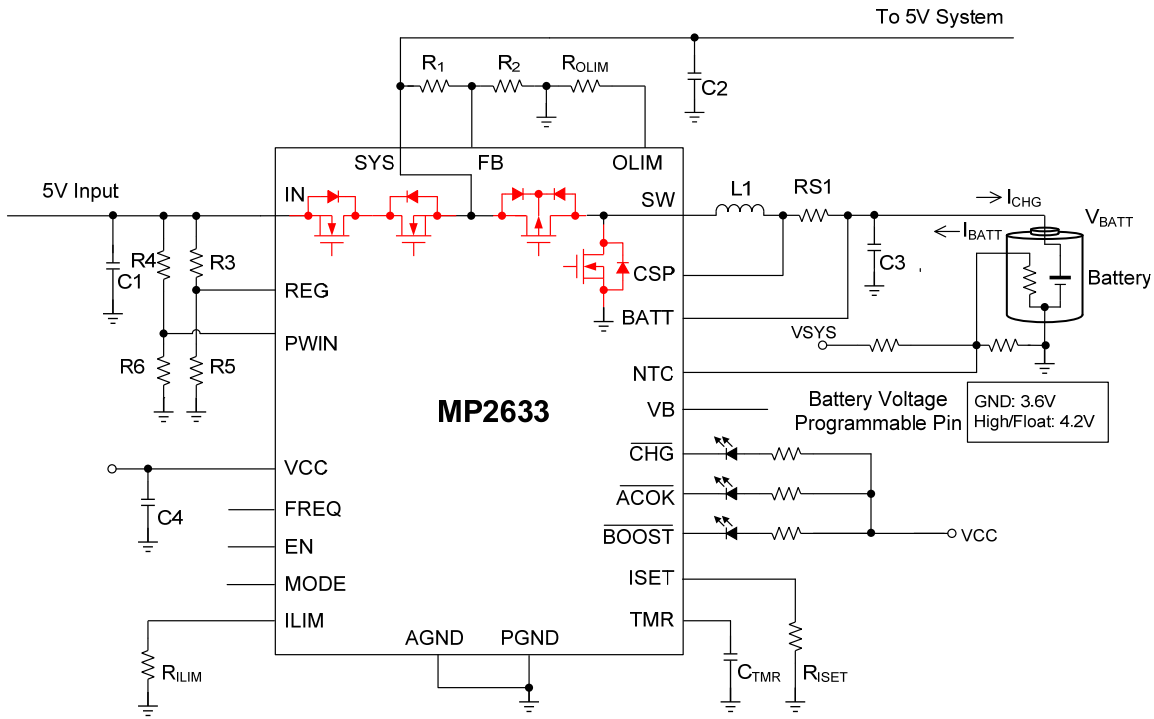
**TYPICAL APPLICATION**

**Table 1: Operation Mode**

Power Source	ACOK	EN	MODE	Operating Mode
$0.8V < PWIN < 1.15V$ & $V_{IN} > V_{BATT} + 300mV$	Low	High	X	Charge Mode, Enable Charging
		Low		Charge Mode, Disable Charging
$PWIN < 0.8V$ or $PWIN > 1.15V$ or $V_{IN} < V_{BATT} + 300mV$	High	X	High	Boost Mode
$V_{IN} < 2V$	High	X	Low	Sleep Mode

X=Don't Care.

### ORDERING INFORMATION

Part Number*	Package	Top Marking
MP2633GR	QFN24 (4×4mm)	M2633E

\* For Tape & Reel, add suffix -Z (e.g. MP2633GR-Z);

### PACKAGE REFERENCE

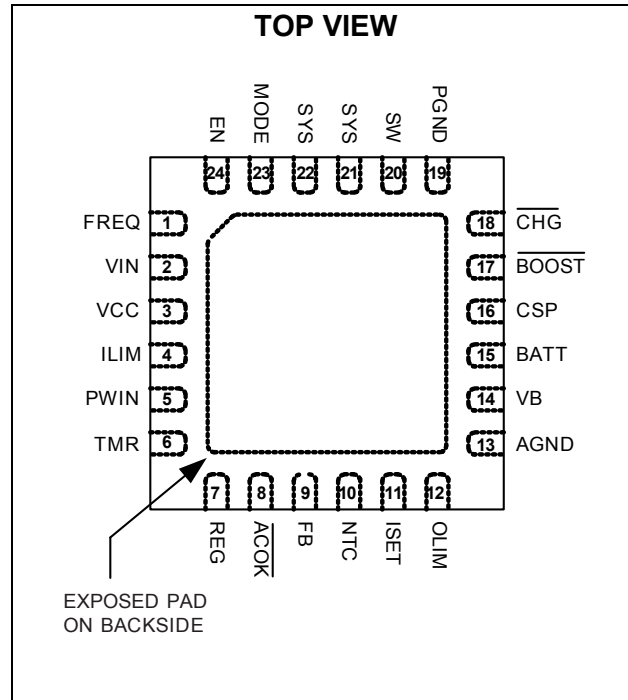

#### ABSOLUTE MAXIMUM RATINGS <sup>(1)</sup>

VIN	-0.3V to 20V
SYS	-0.3V to 6.5V
SW	-0.3V (-2V for <20ns) to 6.5V (8.5V for <20ns)
BATT	-0.3V to 6.5V
ACOK, CHG, BOOST	-0.3V to 6.5V
All Other Pins	-0.3V to 6.5V
Junction Temperature	150°C
Lead Temperature	260°C
Continuous Power Dissipation (T <sub>A</sub> = +25°C) <sup>(2)</sup>	2.97W
Junction Temperature	150°C
Operating Temperature	-20°C to +85°C

#### Recommended Operating Conditions <sup>(3)</sup>

Supply Voltage VIN	4.5V to 6V
Battery Voltage V <sub>OUT</sub>	2.5V to 4.35V
Operating Junction Temp. (T <sub>J</sub> )	-40°C to +125°C

Thermal Resistance <sup>(4)</sup>	$\theta_{JA}$	$\theta_{JC}$
QFN24 (4×4mm)	42	9 ... °C/W

#### Notes:

- Exceeding these ratings may damage the device.
- The maximum allowable power dissipation is a function of the maximum junction temperature T<sub>J</sub> (MAX), the junction-to-ambient thermal resistance  $\theta_{JA}$ , and the ambient temperature T<sub>A</sub>. The maximum allowable continuous power dissipation at any ambient temperature is calculated by P<sub>D</sub> (MAX) = (T<sub>J</sub> (MAX) - T<sub>A</sub>) /  $\theta_{JA}$ . Exceeding the maximum allowable power dissipation will cause excessive die temperature, and the regulator will go into thermal shutdown. Internal thermal shutdown circuitry protects the device from permanent damage.
- The device is not guaranteed to function outside of its operating conditions.
- Measured on JESD51-7, 4-layer PCB.

## ELECTRICAL CHARACTERISTICS

$V_{IN} = 5.0V$ ,  $T_A = 25^{\circ}C$ , unless otherwise noted.

Parameter	Symbol	Condition	Min	Typ	Max	Units
IN to SYS NMOS ON Resistance	$R_{IN\ to\ SYS}$			100		m $\Omega$
High-side PMOS ON Resistance	$R_{H\ DS}$			72		m $\Omega$
Low-side NMOS ON Resistance	$R_{L\ DS}$			70		m $\Omega$
High-Side PMOS Peak Current Limit	$I_{PEAK\_HS}$	CC Charge Mode/Boost Mode		4		A
		TC Charge Mode		1.5		A
Low-Side NMOS Peak Current Limit	$I_{PEAK\_LS}$			4.5		A
Switching Frequency	$f_{SW}$	FREQ = 0		600		kHz
		FREQ = Float/ High		1200		
VCC UVLO	$V_{CC\ UVLO}$		2	2.2	2.4	V
VCC UVLO Hysteresis				100		mV
PWIN, Lower Threshold	$V_{PWIN\ L}$		0.75	0.8	0.85	V
Lower Threshold Hysteresis				40		mV
PWIN, Upper Threshold	$V_{PWIN\ H}$		1.1	1.15	1.2	V
Upper Threshold Hysteresis				65		mV
<b>Charge Mode</b>						
Input Quiescent Current	$I_{IN}$	EN = 5V, Battery Float			2.5	mA
		EN = 0			1.5	mA
Input Current Limit	$I_{IN\_LIMIT}$	$R_{ILIM} = 90.9k$	400	450	500	mA
		$R_{ILIM} = 49.9k$	720	810	900	
		$R_{ILIM} = 20k$	1800	2000	2200	
Input Over-Current Threshold	$I_{IN(OCP)}$			3		A
Input Over-Current Blanking Time <sup>(5)</sup>	$\tau_{INOCBLK}$			120		$\mu s$
Input Over-Current Recovery Time <sup>(5)</sup>	$\tau_{INRECVR}$			100		ms
Terminal Battery Voltage	$V_{BATT\_FULL}$	Connect VB to GND	3.582	3.6	3.618	V
		Leave VB floating or connect to logic HIGH	4.179	4.2	4.221	
Recharge Threshold	$V_{RECH}$	Connect to VB to GND	3.39	3.44	3.49	V
		Leave VB floating or connect to logic HIGH	3.95	4.01	4.07	
Recharge Threshold Hysteresis				200		mV
Battery Over Voltage Threshold				103.3%		$V_{BATT\ FULL}$
Constant Charge (CC) Current	$I_{CC}$	$RS1 = 40m\Omega$ , $R_{ISET} = 69.8k$	900	1000	1100	mA
		$RS1 = 40m\Omega$ , $R_{ISET} = 46.4k$	1350	1500	1650	
Trickle-Charge Current	$I_{TC}$			230		mA

**ELECTRICAL CHARACTERISTICS (continued)**
 **$V_{IN} = 5.0V$ ,  $T_A = 25^\circ C$ , unless otherwise noted.**

Parameter	Symbol	Condition	Min	Typ	Max	Units
Trickle-Charge Voltage Threshold	$V_{BATT\_TC}$	Connect to VB to GND	2.47	2.57	2.67	V
		Leave VB floating or connect to high logic	2.9	3	3.1	
Trickle-Charge Hysteresis				200		mV
Termination Charge Current	$I_{BF}$	$RS1=40m, R_{ISET}=69.8k$	2.5%	10%	17.5%	$I_{CC}$
Input-Voltage-Regulation Reference	$V_{REG}$		1.18	1.2	1.22	V
<b>Boost Mode</b>						
SYS Voltage Range			4.2		6	V
Feedback Voltage			1.18	1.2	1.22	V
Feedback Input Current		$V_{FB}=1V$			200	nA
Boost SYS Over-Voltage Protection Threshold	$V_{SYS(OVP)}$	Threshold over $V_{SYS}$ to turn off the converter during boost mode	5.8	6	6.2	V
SYS Over-Voltage Protection Threshold Hysteresis		$V_{SYS}$ falling from $V_{SYS(OVP)}$		125		mV
Boost Quiescent Current		$I_{SYS} = 0$ , MODE = 5V			1.4	mA
Programmable Boost Output Current Limit Accuracy	$I_{OLIM}$	$RS1 = 40m\Omega$ , $R_{OLIM} = 100k$	1	1.2	1.44	A
Programmable Boost Output Current <sup>(5)</sup>		$RS1 = 50m\Omega$ , $ROLIM=63.4k$	1.5			A
SYS Over-Current Blanking Time <sup>(5)</sup>	$\tau_{SYSOCBLK}$			120		$\mu s$
SYS Over-Current Recovery Time <sup>(5)</sup>	$\tau_{SYSRECVR}$			1		ms
Weak-Battery Threshold	$V_{BATT(LOW)}$	During Boost mode		2.5		V
		Before Boost mode		2.9	3.05	V
<b>Sleep Mode</b>						
Battery Leakage Current	$I_{LEAKAGE}$	$V_{BATT} = 4.2V$ , SYS Float, $V_{IN} = 0V$ , MODE = 0V		15	30	$\mu A$
<b>Indication and Logic</b>						
ACOK, CHG, BOOST pin output low voltage		Sinking 1.5mA			400	mV
ACOK, CHG, BOOST pin leakage current		Connected to 5V			1	$\mu A$
NTC and Time-Out Fault Blinking Frequency <sup>(5)</sup>		$C_{TMR}=0.1\mu F$ , $I_{CHG}=1A$		13.7		Hz
EN Input Logic LOW Voltage					0.4	V
EN Input High Voltage			1.4			V
Mode Input Logic LOW Voltage					0.4	V
Mode Input Logic HIGH Voltage			1.4			V

**ELECTRICAL CHARACTERISTICS** *(continued)*
 $V_{IN} = 5.0V$ ,  $T_A = 25^{\circ}C$ , unless otherwise noted.

Parameter	Symbol	Condition	Min	Typ	Max	Units	
<b>Protection</b>							
Trickle-Charge Time		$C_{TMR}=0.1\mu F$ , remains in TC mode, $I_{CHG}= 1A$		60		Min	
Total Charge Time		$C_{TMR}=0.1\mu F$ , $I_{CHG}= 1A$		360		Min	
NTC Low Temp, Rising Threshold		$R_{NTC}=NCP18XH103(0^{\circ}C)$	65%	66%	67%	$V_{SYS}$	
NTC Low Temp, Rising Threshold Hysteresis				1%			
NTC High Temp, Rising Threshold		$R_{NTC}=NCP18XH103(50^{\circ}C)$	34%	35%	36%		
NTC High Temp, Rising Threshold Hysteresis				1%			
Charging Current Fold-back Threshold <sup>(5)</sup>		Charge Mode		120			$^{\circ}C$
Thermal Shutdown Threshold <sup>(5)</sup>				150			$^{\circ}C$

**Notes:**

5) Guaranteed by design.

## TYPICAL CHARACTERISTICS

$C_{IN}=C_{BATT}=C_{SYS}=C3=22\mu F$ ,  $C1=C2=1\mu F$ ,  $L1=4.7\mu H$ ,  $RS1=50m\Omega$ ,  $C4=C_{TMR}=0.1\mu F$ , Battery Simulator, unless otherwise noted.

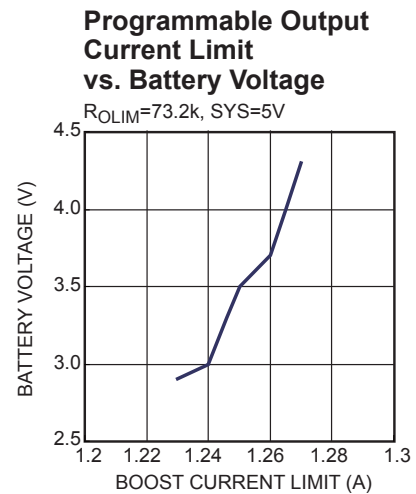
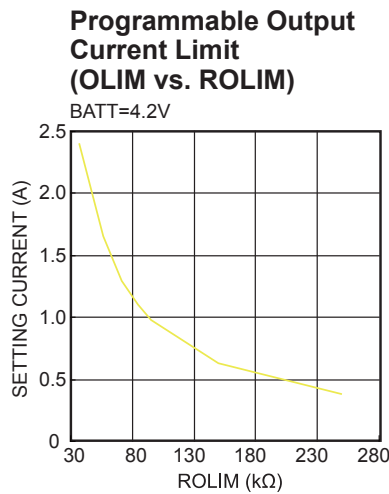
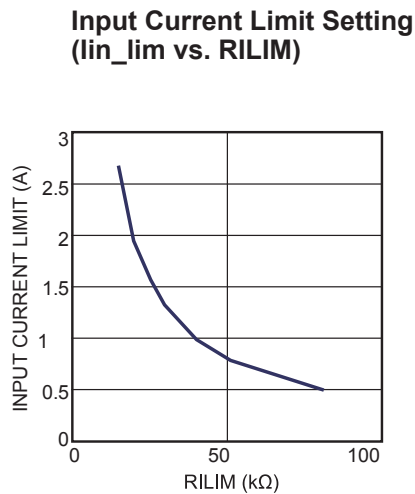
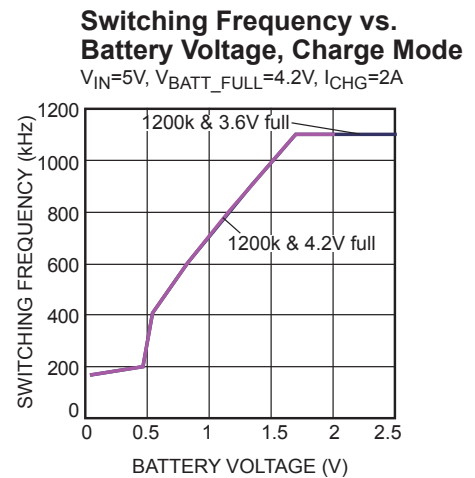
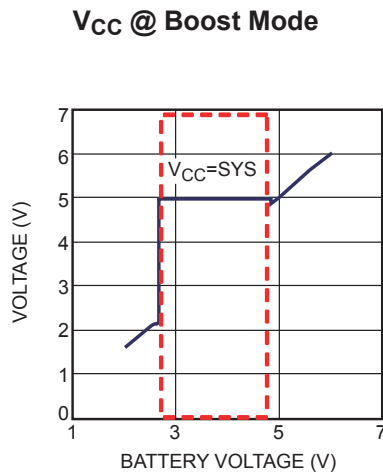
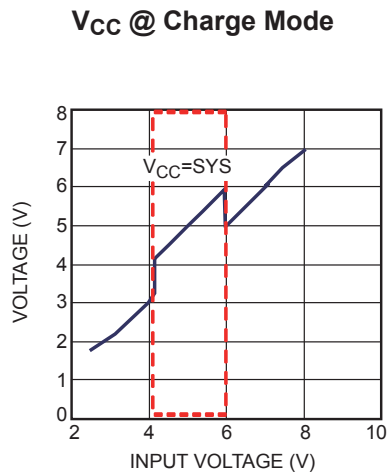
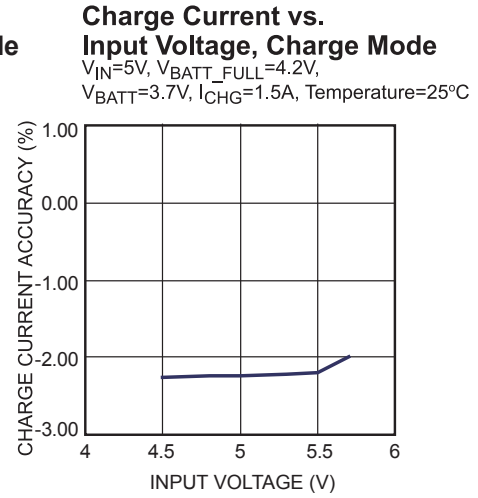
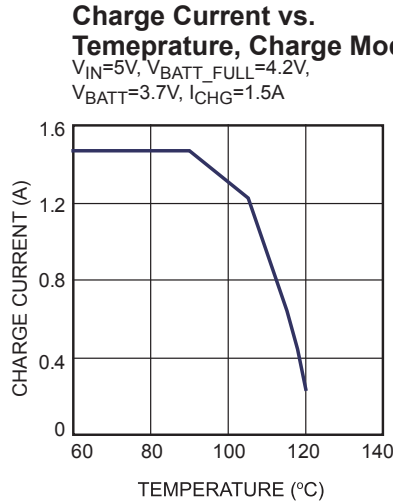
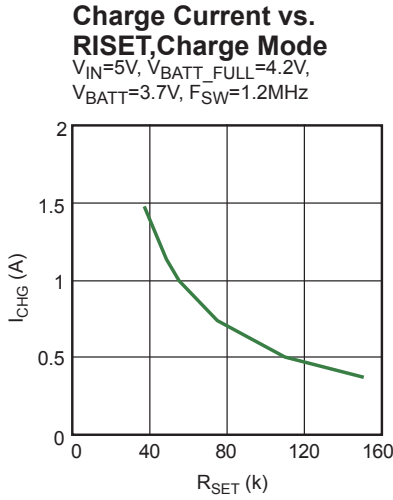

**TYPICAL PERFORMANCE CHARACTERISTICS**

$V_{IN}=5V$ ,  $C_{IN}=C_{BATT}=C_{SYS}=C3=22\mu F$ ,  $C1=C2=1\mu F$ ,  $L1=2.2\mu H$ ,  $RS1=50m\Omega$ ,  $C4=C_{TMR}=0.1\mu F$ , Battery Simulator, unless otherwise noted.

**Battery Charge Curve**  
 $V_{BATT\_FULL} = 4.2V$

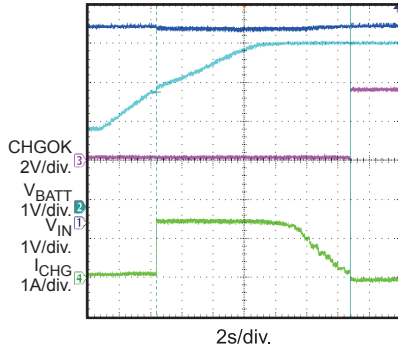

**Auto Recharge**  
 $V_{BATT\_FULL} = 4.2V$

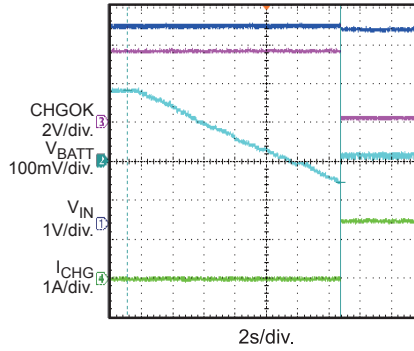

**Battery Float Steady State**  
 $V_{BATT\_FULL} = 4.2V$

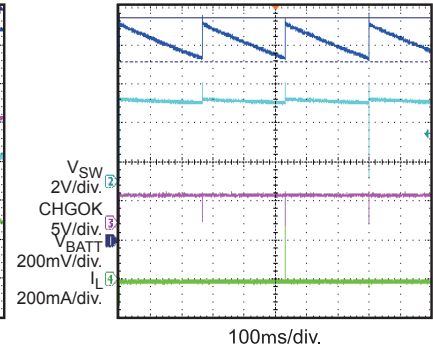

**TC Charge Steady State**  
 $V_{BATT\_FULL} = 4.2V$ ,  $V_{BATT} = 2V$ ,  
 $F_{SW} = 600kHz$

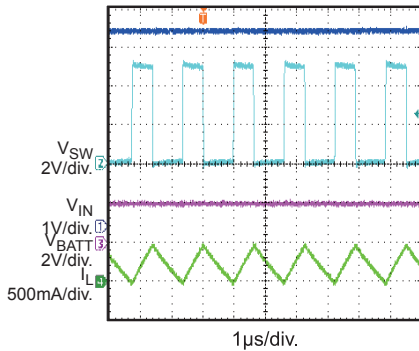

**CC Charge Steady State**  
 $V_{BATT\_FULL} = 4.2V$ ,  $V_{BATT} = 3.7V$ ,  
 $F_{SW} = 600kHz$

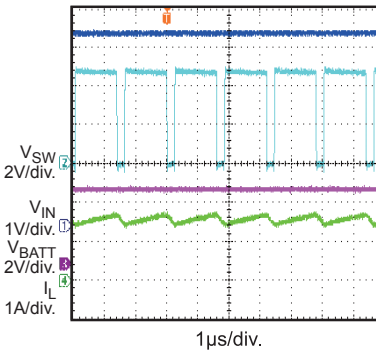

**CV Charge Steady State**  
 $V_{BATT\_FULL} = 4.2V$ ,  $V_{BATT} = 4.2V$ ,  
 $F_{SW} = 600kHz$

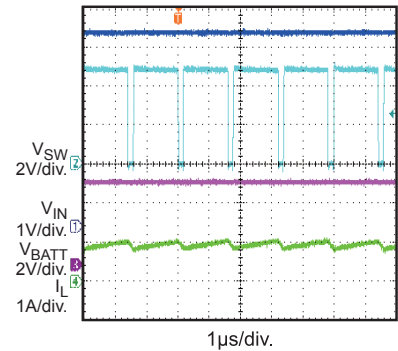

**Constant Current Charge Efficiency**  
 $V_{BATT\_FULL} = 4.2V$ ,  $V_{BATT} = 0.5-4.2V$ ,  
 $F_{SW} = 600kHz$

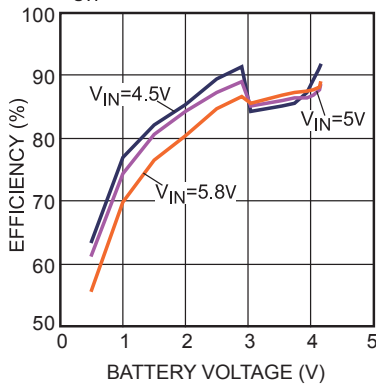

**Constant Voltage Charge Efficiency**  
 $V_{BATT\_FULL} = 4.2V$ ,  $V_{BATT} = 4.2V$ ,  
 $F_{SW} = 600kHz$

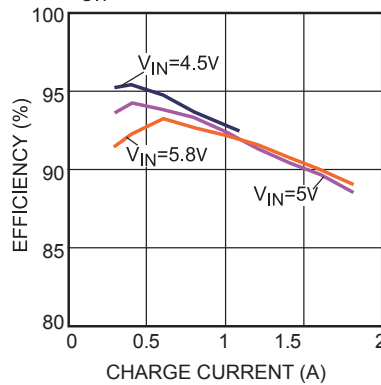



**TYPICAL PERFORMANCE CHARACTERISTICS (continued)**

$V_{IN}=5V$ ,  $C_{IN}=C_{BATT}=C_{SYS}=C3=22\mu F$ ,  $C1=C2=1\mu F$ ,  $L1=2.2\mu H$ ,  $R_{S1}=50m\Omega$ ,  $C4=C_{TMR}=0.1\mu F$ , Battery Simulator, unless otherwise noted.

**Power On, Charge Mode**

$V_{BATT\_FULL}=4.2V$ ,  $V_{BATT}=3.7V$ ,  
 $I_{CHG}=1.5A$

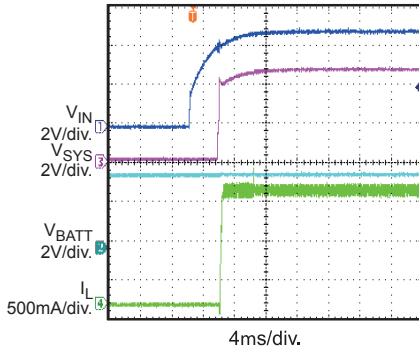
**Power Off, Charge Mode**

$V_{BATT\_FULL}=4.2V$ ,  $V_{BATT}=3.7V$ ,  
 $I_{CHG}=1.5A$

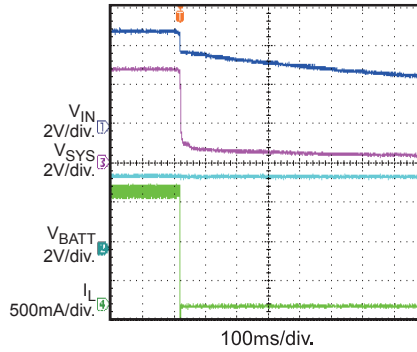
**En On, Charge Mode**

$V_{BATT\_FULL}=4.2V$ ,  $V_{BATT}=3.7V$ ,  
 $I_{CHG}=1.5A$

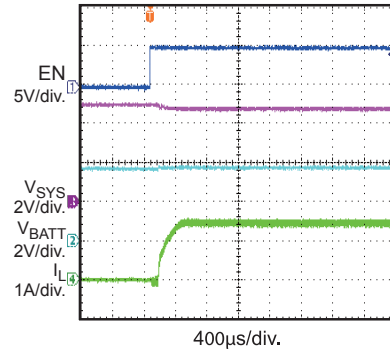
**En Off, Charge Mode**

$V_{BATT\_FULL}=4.2V$ ,  $V_{BATT}=3.7V$ ,  
 $I_{CHG}=1.5A$

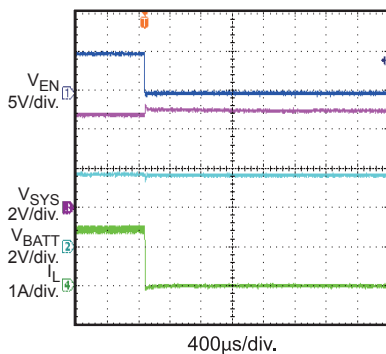
**Input Current Limit**

$V_{BATT\_FULL}=4.2V$ ,  $V_{BATT}=3.7V$ ,  
 $I_{CHG}=1.5A$

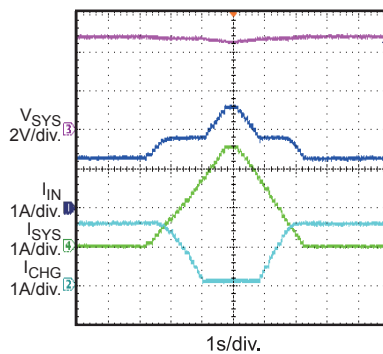
**Input Over Voltage Protection**

$V_{IN}=5V$  to  $12V$ ,  $R_{SYS\_LOAD}=25\Omega$ ,  
Battery Float, Enabled Charge

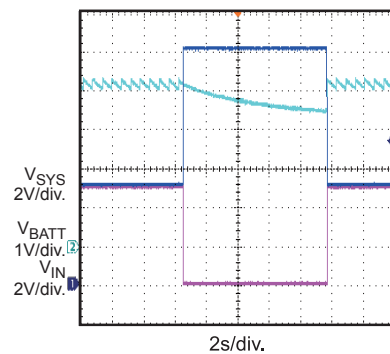
**System Short Protection**

$V_{BATT\_FULL}=4.2V$ ,  $V_{BATT}=2V$ ,  
 $F_{SW}=600kHz$

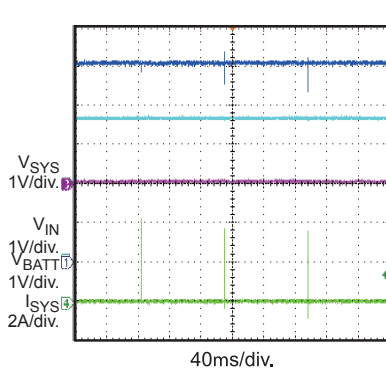
**System Short Protection Zoom In**

$V_{BATT\_FULL}=4.2V$ ,  $V_{BATT}=2V$ ,  
 $F_{SW}=600kHz$

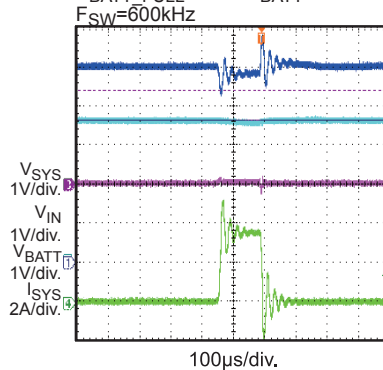
**Input Voltage Clamp @ 4.75V Charge Mode**

$V_{IN\_regulation}=4.75V$ ,  $V_{BATT\_FULL}=4.2V$ ,  
 $V_{BATT}=3.7V$ ,  $I_{CHG}=1.5A$ , Increase  $I_{SYS}$

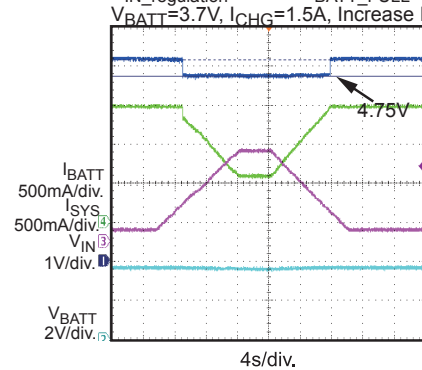

**TYPICAL PERFORMANCE CHARACTERISTICS (continued)**

$V_{IN}=5V$ ,  $C_{IN}=C_{BATT}=C_{SYS}=C3=22\mu F$ ,  $C1=C2=1\mu F$ ,  $L1=2.2\mu H$ ,  $RS1=50m\Omega$ ,  $C4=C_{TMR}=0.1\mu F$ , Battery Simulator, unless otherwise noted.

**Power On, Boost Mode**

$V_{SYS\_SET}=5V$ ,  $V_{BATT}=3.7V$ ,  
No SYS Load

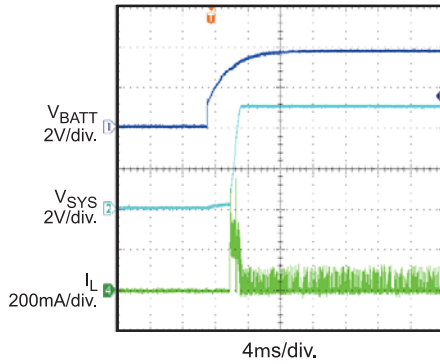
**Power Off, Boost Mode**

$V_{SYS\_SET}=5V$ ,  $V_{BATT}=3.7V$ ,  
No SYS Load

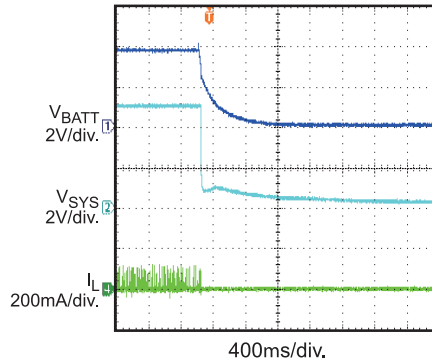
**Power On, Boost Mode**

$V_{SYS\_SET}=5V$ ,  $V_{BATT}=3V$ ,  
 $R_{SYS\_LOAD}=5\Omega$

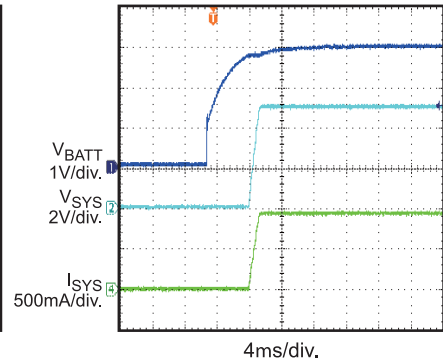
**Power Off, Boost Mode**

$V_{SYS\_SET}=5V$ ,  $V_{BATT}=3V$ ,  
 $R_{SYS\_LOAD}=5\Omega$

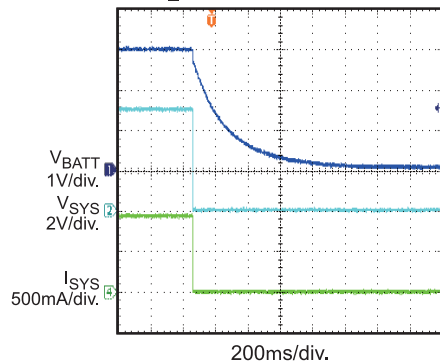
**Mode On, Boost Mode**

$V_{SYS\_SET}=5V$ ,  $V_{BATT}=3.7V$ ,  
No SYS Load

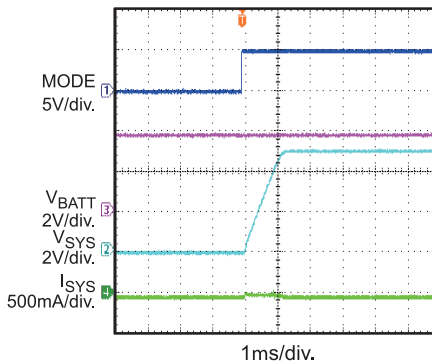
**Mode Off, Boost Mode**

$V_{SYS\_SET}=5V$ ,  $V_{BATT}=3.7V$ ,  
No SYS Load

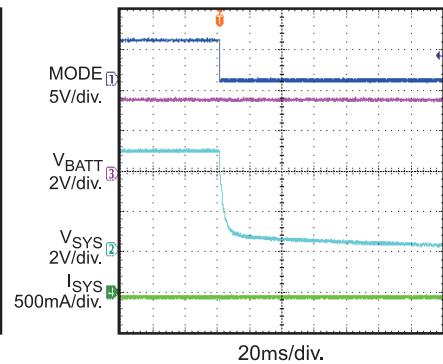
**Mode On, Boost Mode**

$V_{SYS\_SET}=5V$ ,  $V_{BATT}=3.7V$ ,  
 $R_{SYS\_LOAD}=5\Omega$

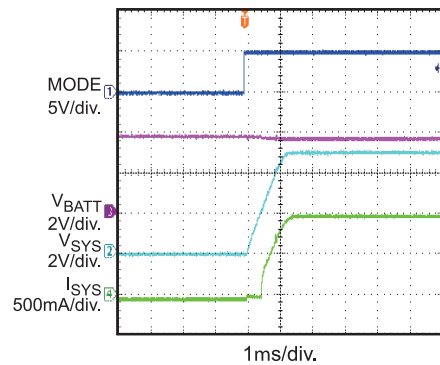
**Mode Off, Boost Mode**

$V_{SYS\_SET}=5V$ ,  $V_{BATT}=3.7V$ ,  
 $R_{SYS\_LOAD}=5\Omega$

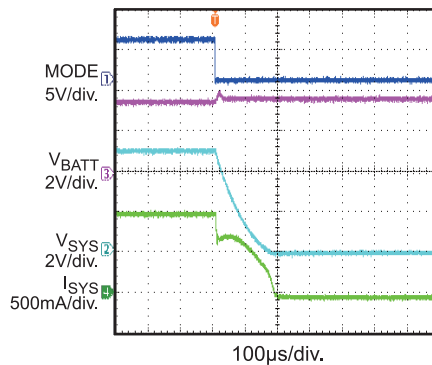
**SYS Output Current Limit, Boost Mode**

$V_{SYS\_SET}=5V$ ,  $V_{BATT}=3.7V$ ,  
 $I_{OLIM\_SET}=1A$

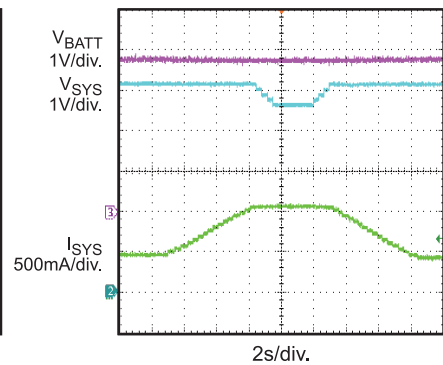

**TYPICAL PERFORMANCE CHARACTERISTICS (continued)**

$V_{IN}=5V$ ,  $C_{IN}=C_{BATT}=C_{SYS}=C3=22\mu F$ ,  $C1=C2=1\mu F$ ,  $L1=2.2\mu H$ ,  $RS1=50m\Omega$ ,  $C4=C_{TMR}=0.1\mu F$ , Battery Simulator, unless otherwise noted.

**SYS short Entry Boost Mode**

$V_{SYS\_SET}=5V$ ,  $V_{BATT}=3.7V$

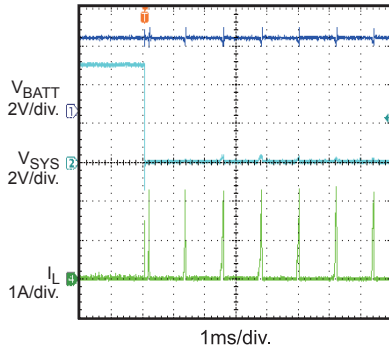
**SYS Short Recovery Boost Mode**

$V_{SYS\_SET}=5V$ ,  $V_{BATT}=3.7V$

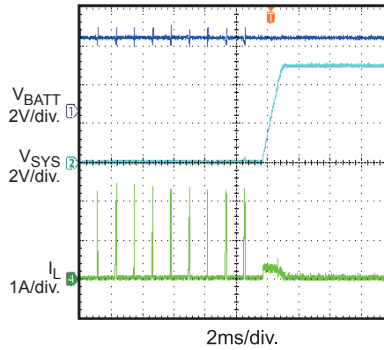
**SYS Over Voltage Protection, Boost Mode**

$V_{SYS\_SET}=6.5V$ ,  $V_{BATT}=3.7V$

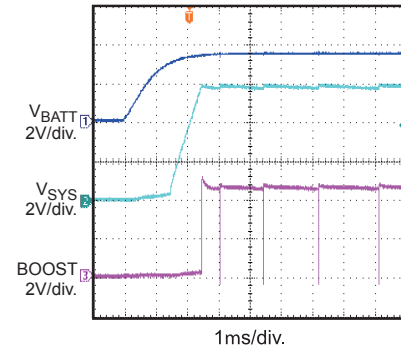
**SYS Load Transient, Boost Mode**

$V_{SYS\_SET}=5V$ ,  $V_{BATT}=3.7V$ ,  
 $I_{SYS}=100mA$  to  $1A$

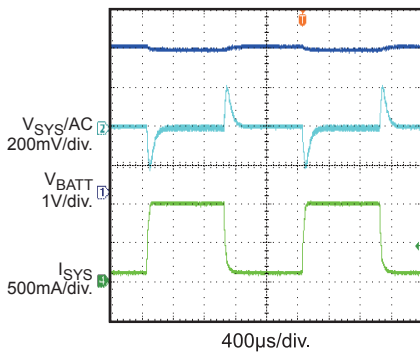
**SYS Load Transient, Boost Mode**

$V_{SYS\_SET}=5V$ ,  $V_{BATT}=3.7V$ ,  
 $I_{SYS}=500mA$  to  $1A$

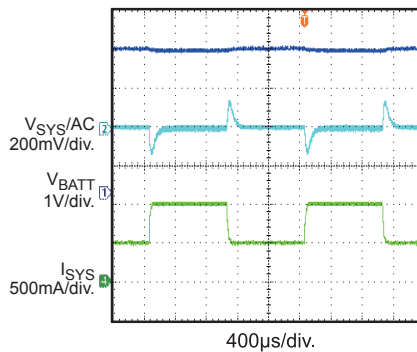
**SYS Short Steady State Boost Mode**

$V_{SYS\_SET}=5V$ ,  $V_{BATT}=3.7V$

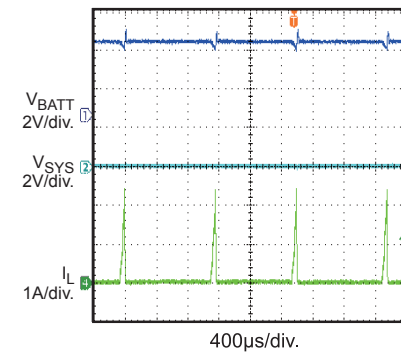
**Efficiency, Boost Mode**

$V_{SYS\_SET}=5V$ ,  $V_{SYS}=5V$ ,  
 $F_{SW}=1.2MHz$

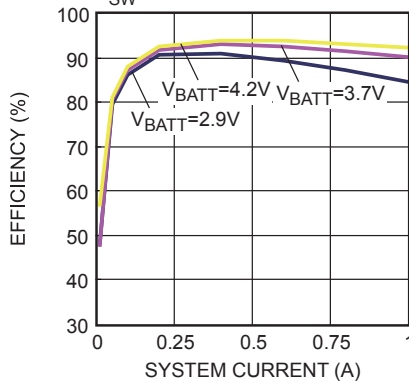
**Efficiency, Boost Mode**

$V_{SYS\_SET}=5V$ ,  $V_{SYS}=5V$ ,  
 $F_{SW}=600kHz$

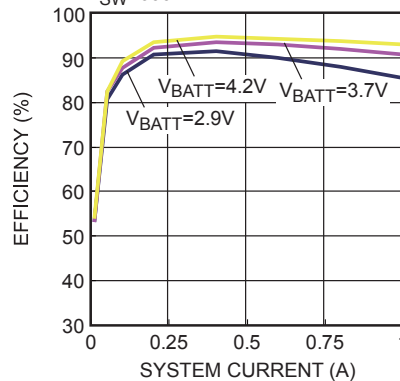
**Boost Output V-I Curve**

$BATT=3.7V$ ,  $SYS=5V$

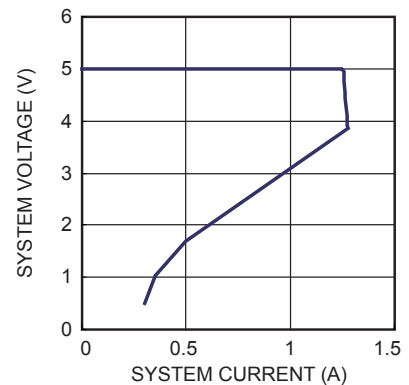

## PIN FUNCTIONS

Pin #	Name	Description
1	FREQ	Connect to GND to program the operating frequency to 600kHz. Leave floating or connect to HIGH to program the operating frequency to 1.2MHz.
2	VIN	Adapter Input. Place a bypass capacitor close to this pin to prevent large input voltage spikes.
3	VCC	Internal Circuit Power Supply. Bypass to GND with a 100nF ceramic capacitor. This pin can not carry external load higher than 5mA.
4	ILIM	Input Current Set. Connect to GND with an external resistor to program input current limit in charge mode.
5	PWIN	AC Input Detect. Detect the presence of valid input power.
6	TMR	Oscillator Period Timer. Connect a timing capacitor between this pin and GND to set the oscillator period. Short to GND to disable the Timer function.
7	REG	Input Voltage Feedback for input voltage regulation loop. Connect to tap of an external resistor divider from VIN to GND to program the input voltage regulation. Once the voltage at REG pin drops to the inner threshold, the charge current is reduced to maintain the input voltage at the regulation value.
8	ACOK	Valid Input Supply Indicator. Logic LOW indicates the presence of a valid power supply.
9	FB	System Voltage Feedback.
10	NTC	Negative Temperature Coefficient (NTC) Thermistor.
11	ISET	Charge Current Set. Connect an external resistor to GND to program the charge current.
12	OLIM	Boost-Output-Current Limit Set. Connect an external resistor to GND to program the system current in boost mode.
13	AGND	Analog Ground
14	VB	Programmable Battery-Full Voltage. Connect to GND for 3.6V. Leave floating or connect to logic HIGH for 4.2V.
15	BATT	Positive Battery Terminal / Battery Charge Current Sense Negative Input.
16	CSP	Battery Charge Current Sense, Positive Input.
17	BOOST	Boost Mode Indicator. Logic LOW indicates boost mode in operation. This pin becomes an open drain when the part operates in charge mode or sleep mode.
18	CHG	Charge Completion indicator. Logic LOW indicates charge mode. The pin becomes an open drain once the charging has completed or is suspended.
19	PGND, Exposed Pad	Power Ground. Connect the exposed pad and GND pin to the same ground plane.
20	SW	Switch Output Node.
21, 22	SYS	System Output. <b>Please make sure the enough bulk capacitors from SYS to GND. Suggest 4.7uF at least.</b>
23	MODE	Mode Select. Logic HIGH→boost mode. Logic LOW→sleep mode. Active only when $\overline{\text{ACOK}}$ is HIGH (input power is not available).
24	EN	Charge Control Input. Logic HIGH enables charging. Logic LOW disables charging. Active only when $\overline{\text{ACOK}}$ is low (input power is OK)

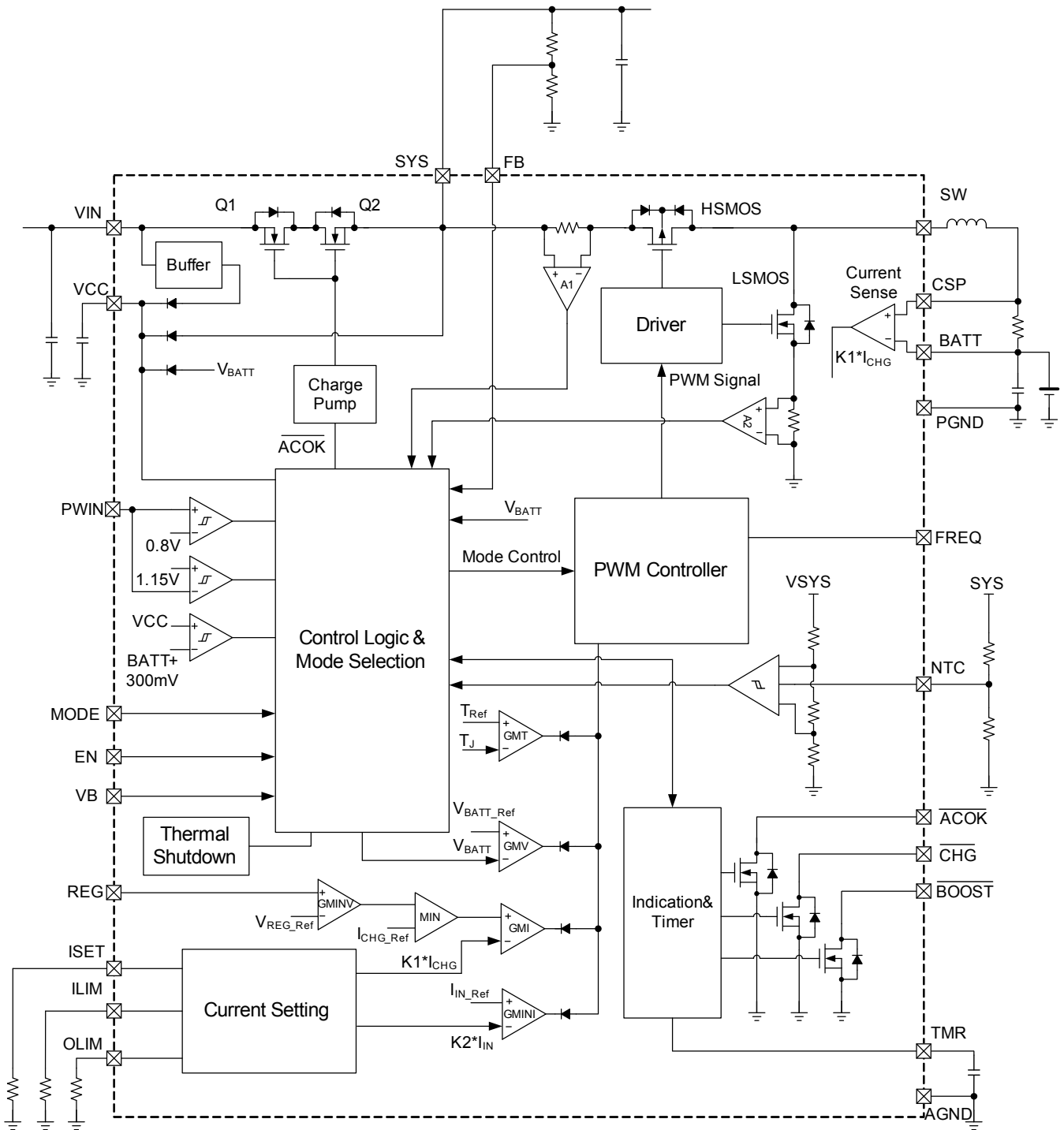

Figure 1: Functional Block Diagram in Charge Mode

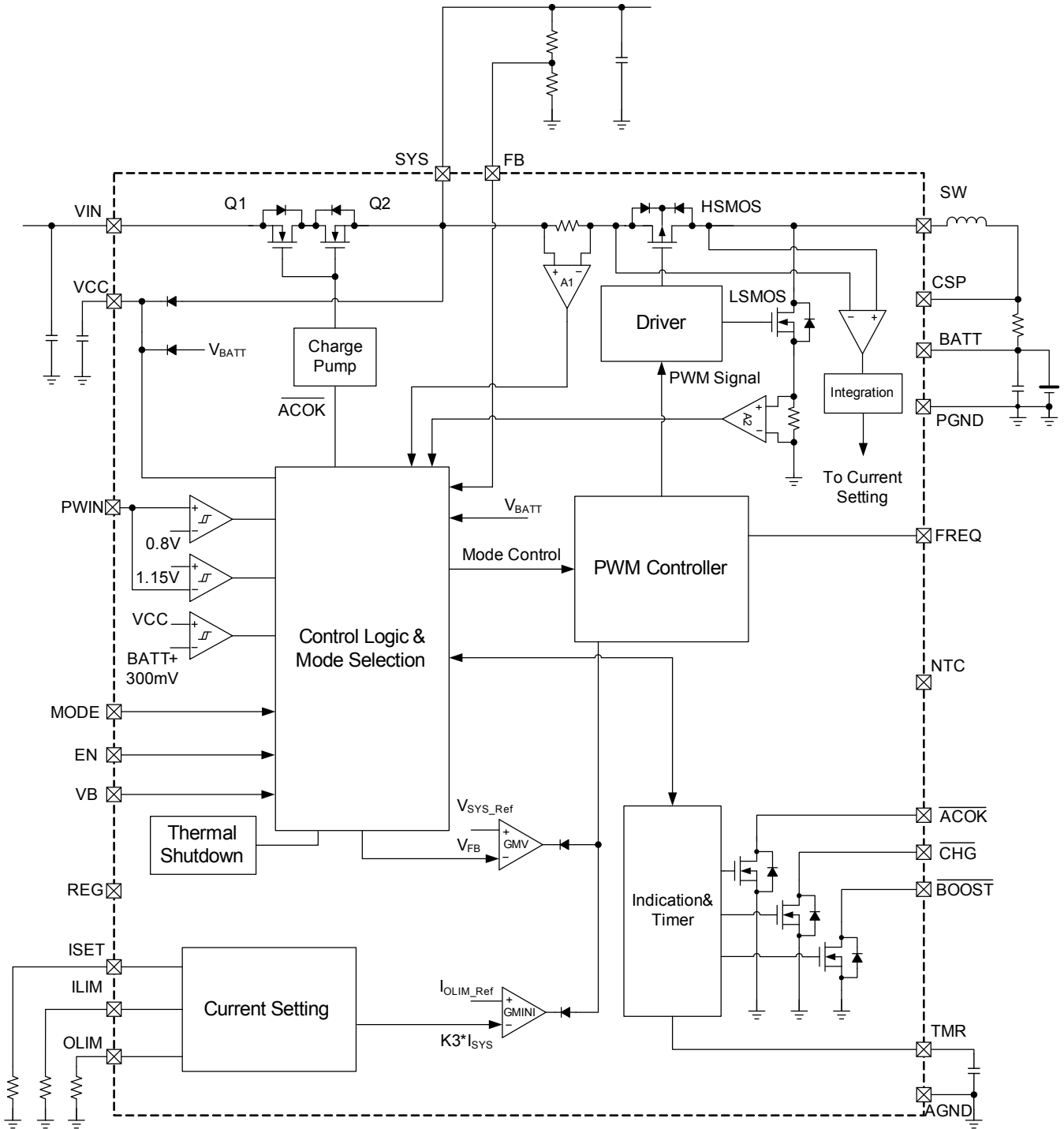

Figure 2: Functional Block Diagram in Boost Mode

OPERATION FLOW CHART

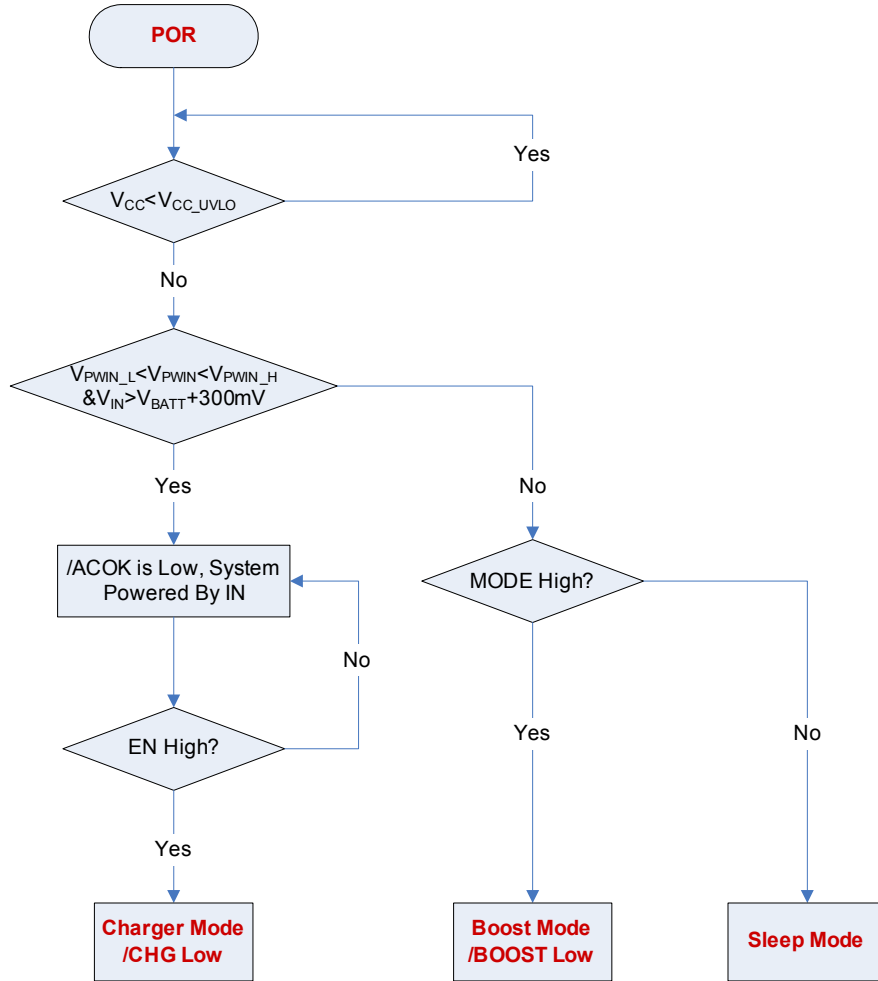

Figure 3: Mode Selection Flow Chart

OPERATION FLOW CHART (continued)

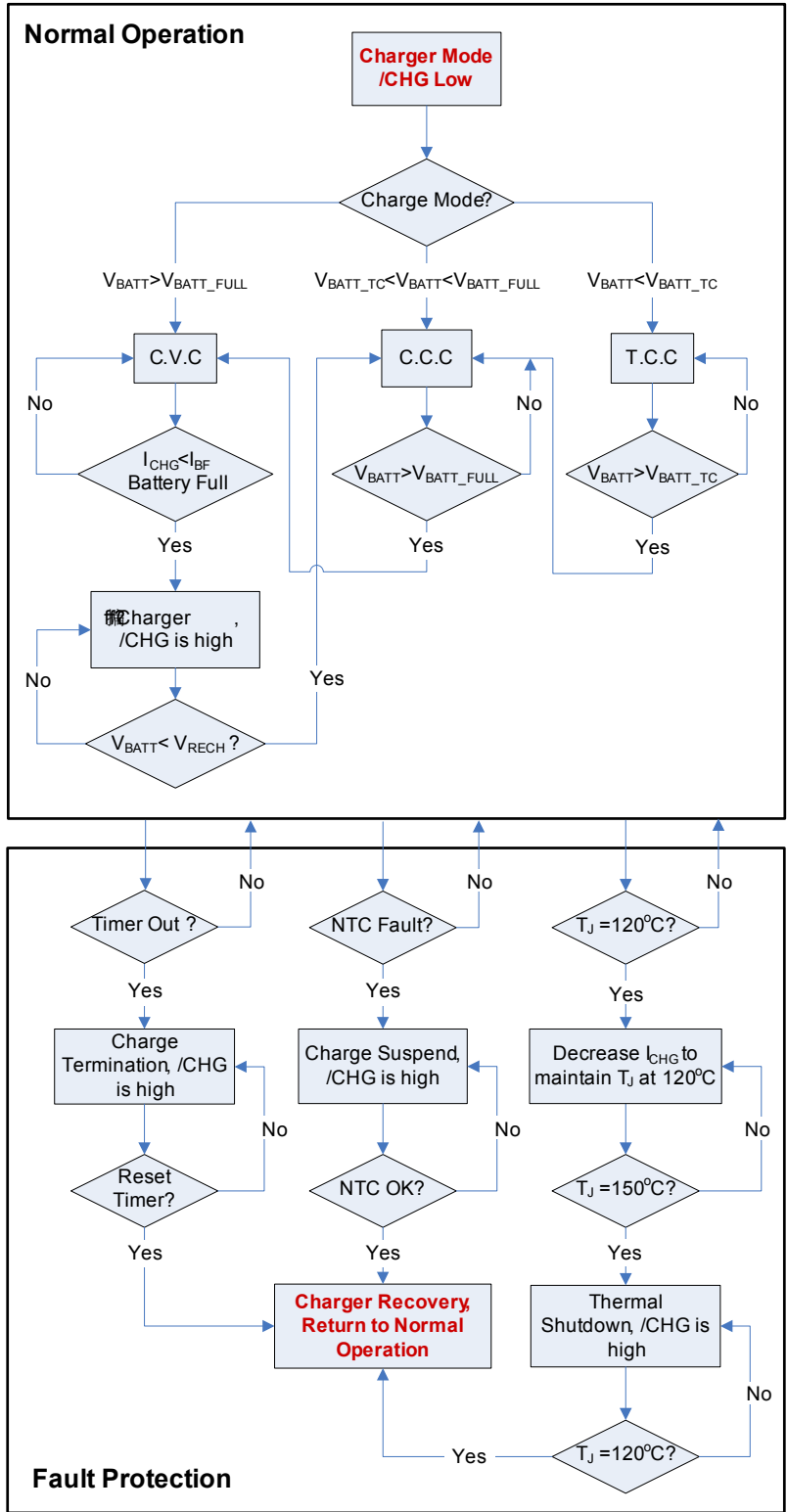

Figure 4: Normal Operation and Fault Protection in Charge Mode



OPERATION FLOW CHART (continued)

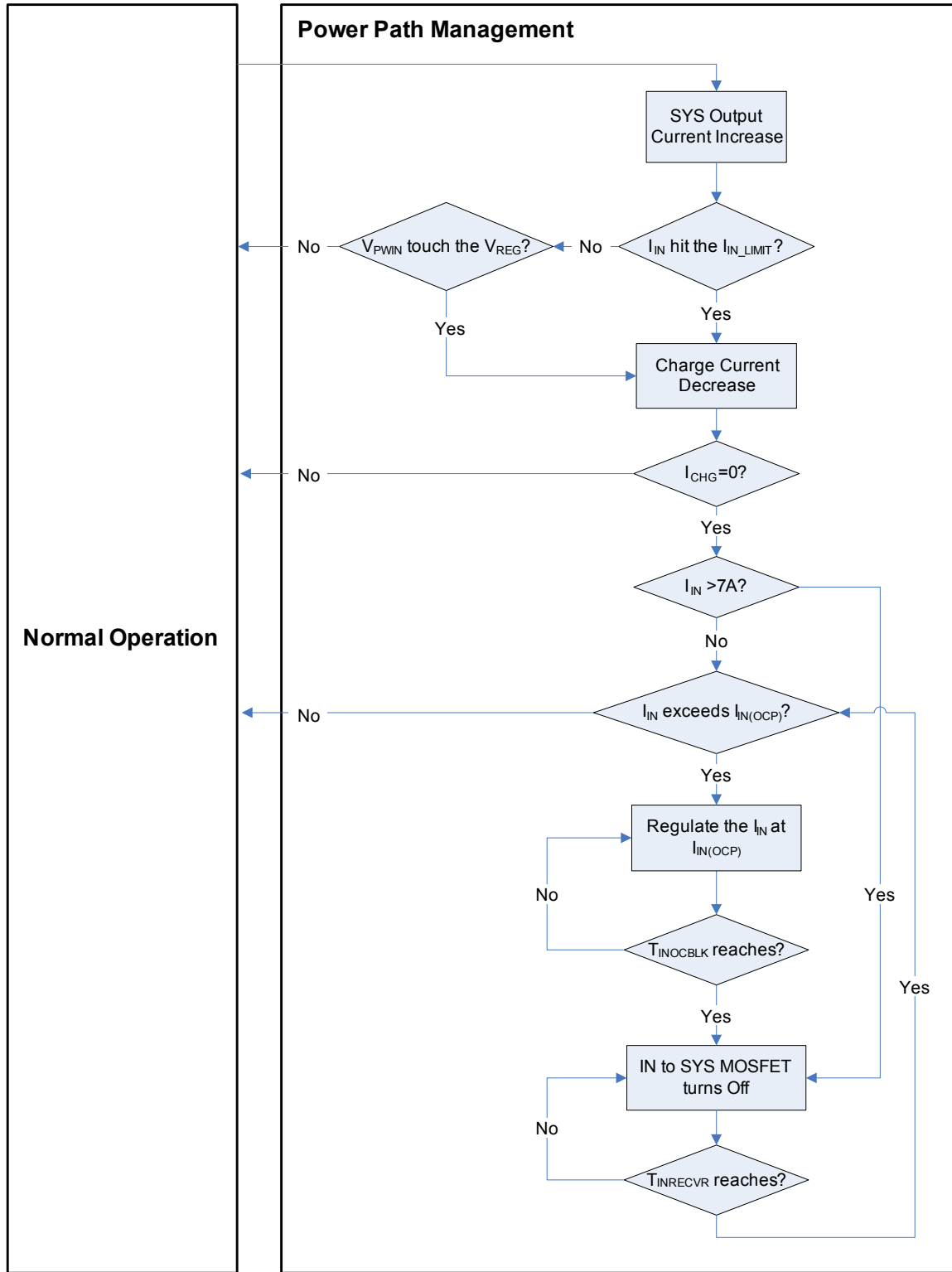

Figure 5: Power-Path Management in Charge Mode

OPERATION FLOW CHART (continued)

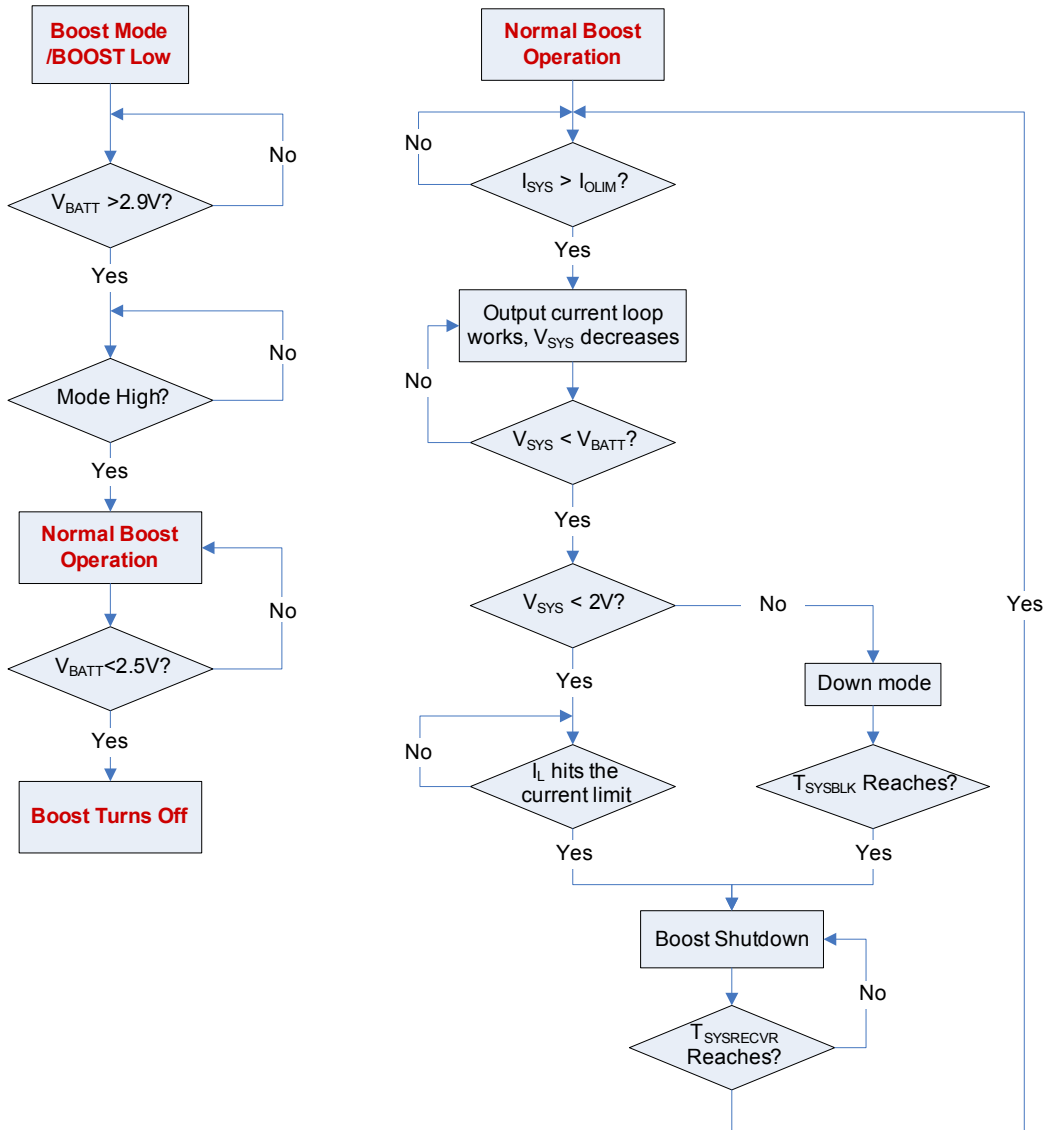
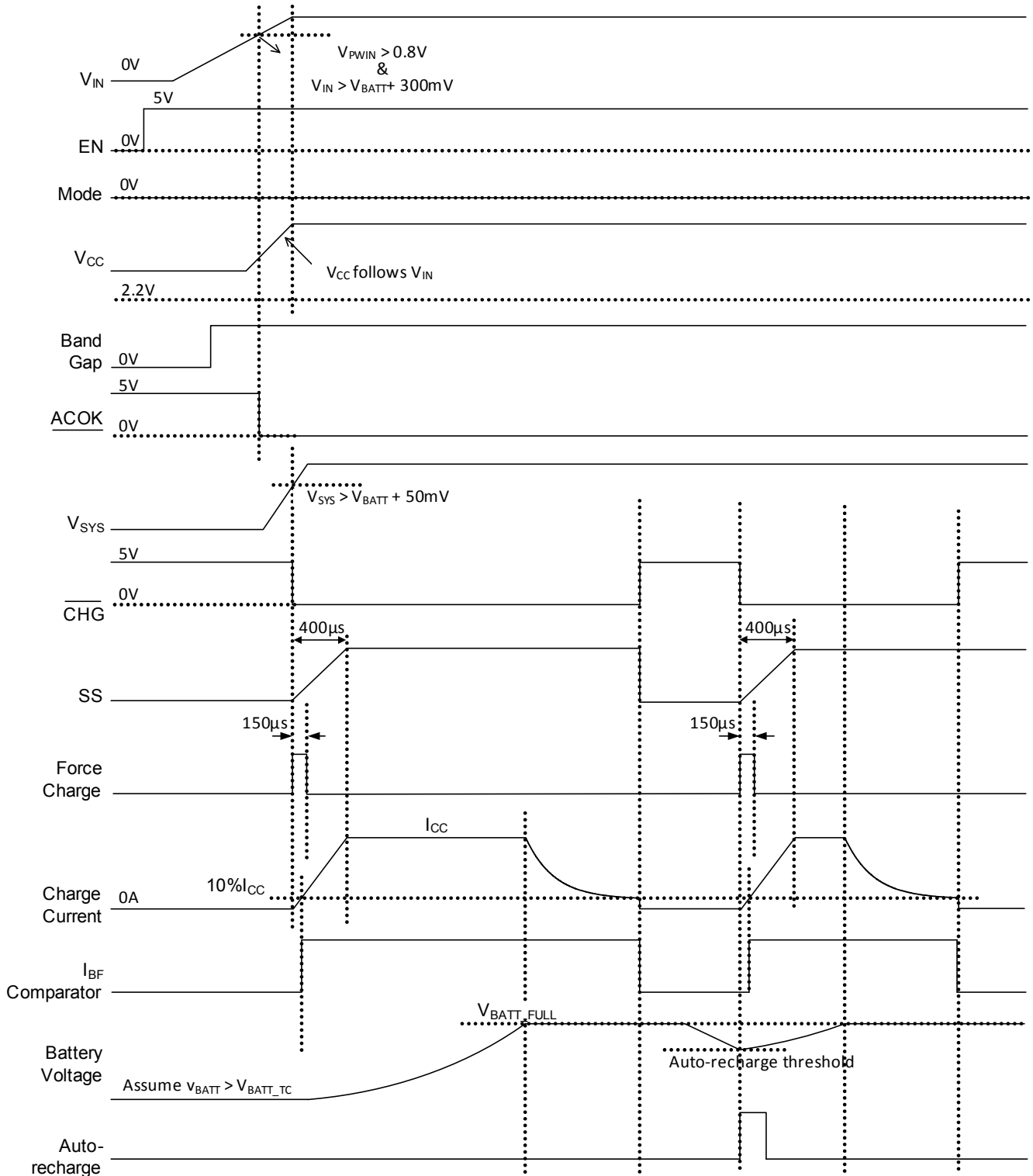

Figure 6: Operation Flow Chart in Boost Mode

**START UP TIME FLOW IN CHARGE MODE**

Condition: EN = 5V, Mode = 0V, /ACOK and /CHG are always pulled up to an external constant 5V



**Figure 7: Input Power Start-Up Time Flow in Charge Mode**

**START UP TIME FLOW IN CHARGE MODE**

Condition:  $V_{IN} = 5V$ , Mode = 0V, /ACOK and /CHG are always pulled up to an external constant 5V.

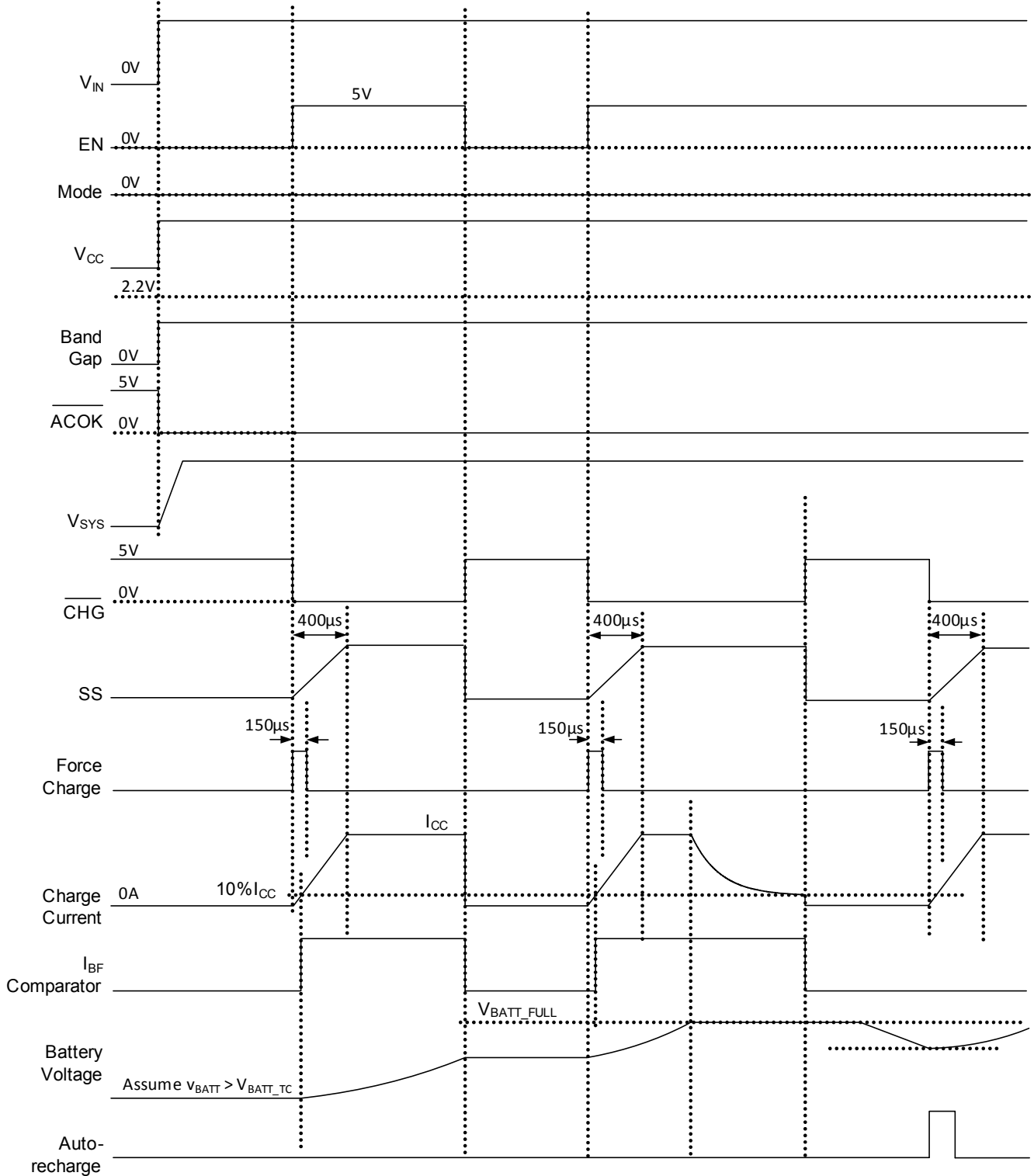

Figure 8: EN Start-Up Time Flow in Charge Mode

### START UP TIME FLOW IN BOOST MODE

Condition:  $V_{IN} = 0V$ , Mode = 5V, /Boost is always pulled up to an external constant 5V.

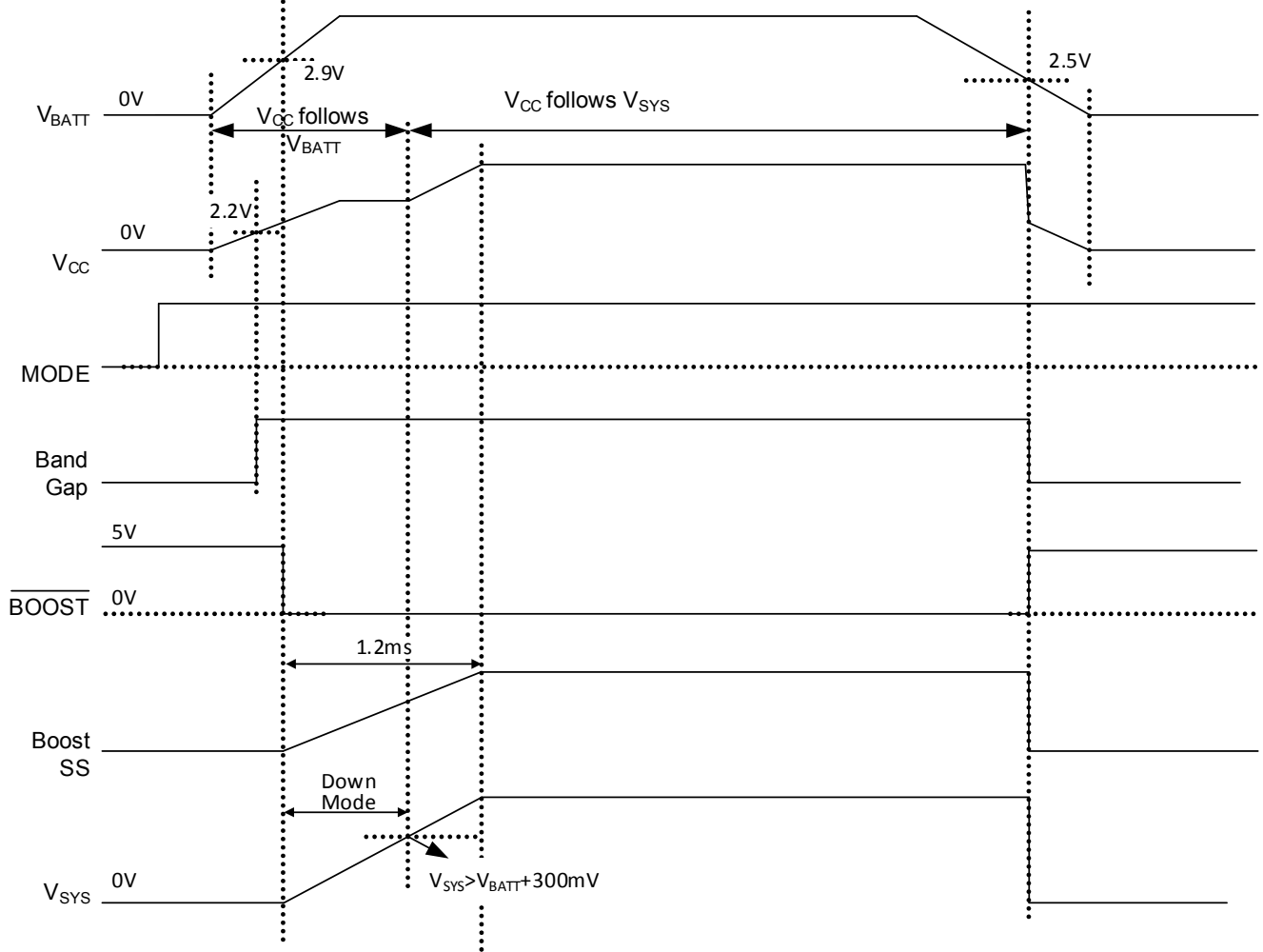

Figure 9: Battery Power Start-Up Time Flow in Boost Mode

### START UP TIME FLOW IN BOOST MODE

Condition:  $V_{IN} = 0V$ , /Boost is always pulled up to an external constant 5V.

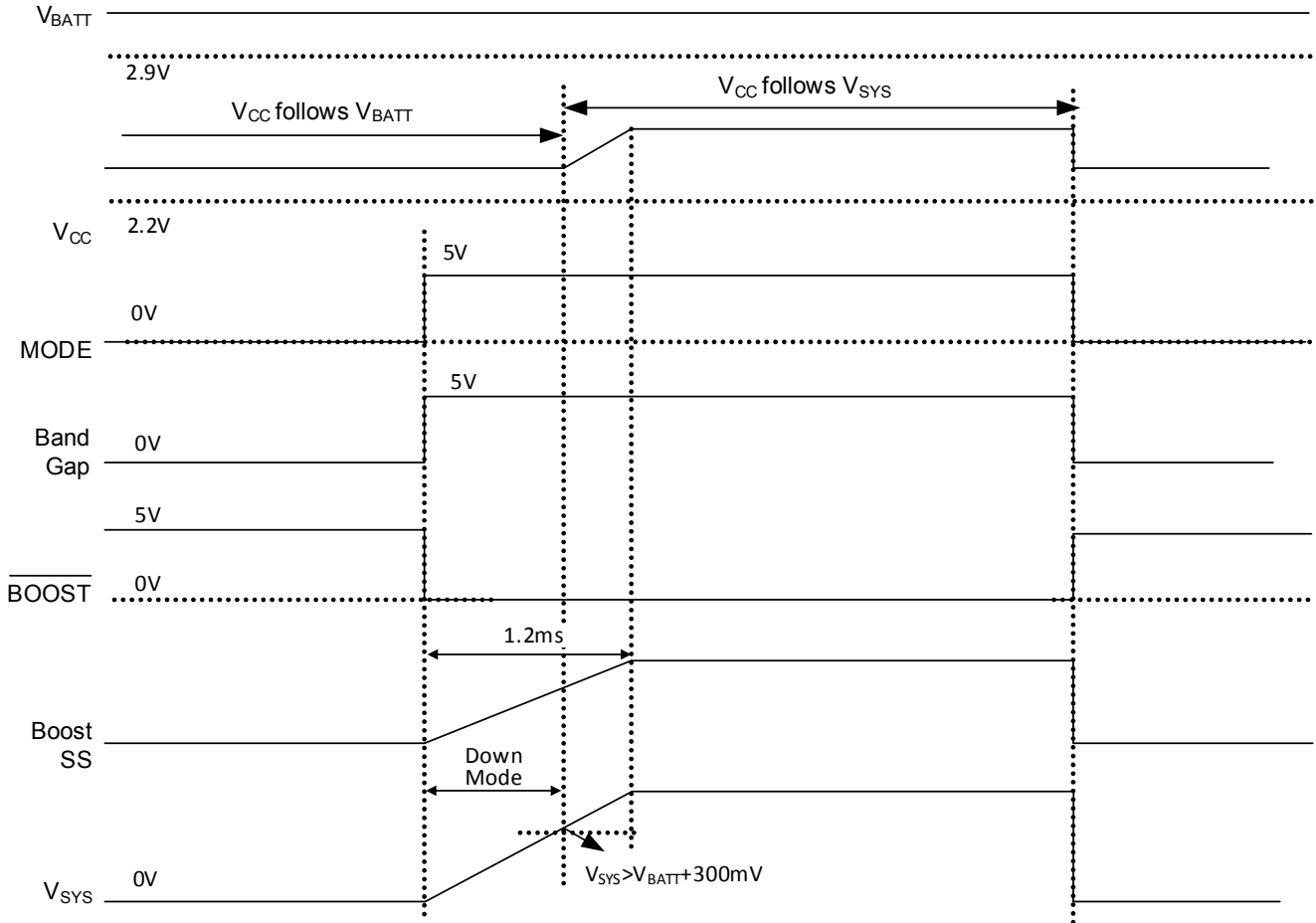

Figure 10: Mode Start-Up Time Flow in Boost Mode

## OPERATION

### INTRODUCTION

The MP2633 is a highly-integrated, synchronous, switching charger with bi-directional operation for a boost function that can step-up the battery voltage to power the system. Depending on the VIN value, it operates in one of three modes: charge mode, boost mode and sleep mode. In charge mode, the MP2633 supports a precision Li-ion or Li-polymer charging system for single-cell applications. In boost mode, MP2633 boosts the battery voltage to  $V_{SYS}$  to power higher-voltage systems. In sleep mode, the MP2633 stops charging or boosting and operates at a low current from the input or the battery to reduce power consumption when the IC isn't operating. The MP2633 monitors VIN to allow smooth transition between different modes of operation.

### CHARGE MODE OPERATION

#### Charge Cycle (Trickle Charge→CC Charge→CV Charge)

In charge mode, the MP2633 has five control loops to regulate the input current, input voltage, charge current, charge voltage, and device junction temperature. It charges the battery in three phases: trickle current (TC), constant current (CC), and constant voltage (CV). While charging, all four loops are active but only one determines the IC behavior. Figure 11(a) shows a typical battery charge profile. The charger stays in TC charge mode until the battery voltage reaches a TC-to-CC threshold. Otherwise the charger enters CC charge mode. When the battery voltage rises to the CV-mode threshold, the charger operates in constant voltage mode. Figure 11 (b) shows a typical charge profile when the input-current-limit loop dominates during the CC charge mode, and in this case the charge current exceeds the input current, resulting in faster charging than a traditional linear solution that is well-suited for USB applications.

#### Auto-Recharge

Once the battery charge cycle completes, the charger remains off. During this process, the system load may consume battery power, or the battery may self discharge. To ensure that the

battery will not go into depletion, a new charge cycle automatically begins when the battery

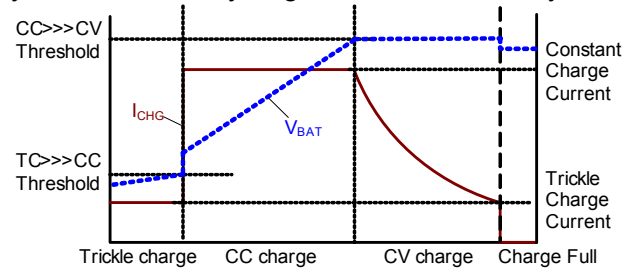

a) Without input current limit

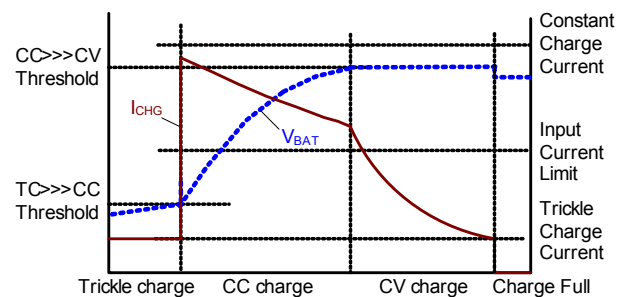

b) With input current limit

**Figure 11: Typical Battery Charging Profile** voltage falls below the auto-recharge threshold and the input power is present. The timer resets when the auto-recharge cycle begins.

During the off state after the battery is fully charged, if the input power re-starts or the EN signal refreshes, the charge cycle will start and the timer will reset no matter what the battery voltage is.

#### Battery Over-Voltage Protection

The MP2633 has battery over-voltage protection. If the battery voltage exceeds the battery over-voltage threshold, (103.3% of the battery-full voltage), charging is disabled. Under this condition, an internal current source draws a current from the BATT pin to decrease the battery voltage and protect the battery.

#### Timer Operation in Charge Mode

The MP2633 uses an internal timer to terminate the charging. The timer remains active during the charging process. An external capacitor between TMR and GND programs the charge cycle duration.

If charging remains in TC mode beyond the trickle-charge time  $\tau_{TOTAL\_TMR}$ , charging will terminate. The following determines the length of the trickle-charge period:

$$\tau_{TRICKLE\_TMR} = 60\text{mins} \times \frac{C_{TMR}(\mu\text{F})}{0.1\mu\text{F}} \times \frac{1\text{A}}{I_{CHG}(\text{A})} \quad (1)$$

The maximum total charge time is:

$$\tau_{TOTAL\_TMR} = 6\text{Hours} \times \frac{C_{TMR}(\mu\text{F})}{0.1\mu\text{F}} \times \frac{1\text{A}}{I_{CHG}(\text{A})} \quad (2)$$

### Negative Temperature Coefficient (NTC) Input for Battery Temperature Monitoring

The MP2633 has a built-in NTC resistance window comparator, which allows the MP2633 to monitor the battery temperature via the battery-integrated thermistor. Connect an appropriate resistor from  $V_{SYS}$  to the NTC pin and connect the thermistor from the NTC pin to GND. The resistor divider determines the NTC voltage depending on the battery temperature. If the NTC voltage falls outside of the NTC window, the MP2633 stops charging. The charger will then restart if the temperature goes back into NTC window range.

### Input-Current Limiting in Charge Mode

The MP2633 has a dedicated pin that programs the input-current limit. The current at ILIM is a fraction of the input current; the voltage at ILIM indicates the average input current of the switching regulator as determined by the resistor value between ILIM and GND. As the input current approaches the programmed input current limit, charge current is reduced to allow priority to system power.

Use the following equation to determine the input current limit threshold,

$$I_{ILIM} = \frac{40.5(\text{k}\Omega)}{R_{ILIM}(\text{k}\Omega)} (\text{A}) \quad (3)$$

### Input Over-Current Protection

The MP2633 features input over-current protection (OCP): when the input current exceeds 3A, Q2 is controlled linearly to regulate the current. If the current still exceeds 3A after a 120 $\mu$ s blanking time, Q2 will turn off. A fast off function turns off Q2 quickly when the input current exceeds 7A to protect both Q1 and Q2.

### Input Voltage Regulation in Charge Mode

In charge mode, if the input power source is not sufficient to support both the charge current and system load current, the input voltage will decrease. As the input voltage approaches the programmed input voltage regulation value, charge current is reduced to allow priority of system power and maintain the input voltage avoid dropping further.

The input voltage can be regulated by a resistor divider from VIN pin to REG pin to AGND according to the following expression:

$$V_{IN\_R} = V_{REG} \times \frac{R3 + R5}{R5} \quad (4)$$

Where: the VREG is the internal voltage reference, 1.2V.

### Setting the Charge Current

The external sense resistors, RS1 and  $R_{ISET}$ , program the battery charge current,  $I_{CHG}$ . Select  $R_{ISET}$  based on RS1:

$$I_{CHG}(\text{A}) = \frac{70(\text{k}\Omega)}{R_{ISET}(\text{k}\Omega)} \times \frac{40(\text{mV})}{RS1(\text{m}\Omega)} \quad (5)$$

Where: the 40mV is the charge current limit reference.

### Battery Short Protection

The MP2633 has two current limit thresholds. CC and CV modes have a peak current limit threshold of 3A, while TC mode has a current limit threshold of 1.5A. Therefore, the current limit threshold decreases to 1.5A when the battery voltage drops below the TC threshold. Moreover, the switching frequency also decreases when the BATT voltage drops to 40% of the charge-full voltage.

### Thermal Foldback Function

The MP2633 implements thermal protection to prevent thermal damage to the IC and the surrounding components. An internal thermal sense and feedback loop automatically decreases the programmed charge current when the die temperature reaches 120°C. This function is called the charge-current-thermal foldback. Not only does this function protect against thermal damage, it can also set the charge current based



on requirements rather than worst-case conditions while ensuring safe operation. Furthermore, the part includes thermal shutdown protection where the ceases charging if the junction temperature rises to 150°C.

### Fully Operation Indication

The MP2633 integrates indicators for the following conditions as shown in Table 2.

**Table 2: Indicator for Each Operation Mode**

Operation		ACOK	CHG	BOOST
Charge Mode	Charging	Low	Low	High
	End of Charge, charging disabled		High	
	NTC Fault, Timer Out		Blinking	
Boost Mode		High	High	Low
Sleep Mode, VCC absent		High	High	High

## BOOST MODE OPERATION

### Low-Voltage Start-Up

The minimum battery voltage required to start up the circuit in boost mode is 2.9V. Initially, when  $V_{SYS} < V_{BATT}$ , the MP2633 works in down mode. In this mode, the synchronous P-MOSFET stops switching and its gate connects to  $V_{BATT}$  statically. The P\_MOSFET keeps off as long as the voltage across the parasitic  $C_{DS}$  ( $V_{SW}$ ) is lower than  $V_{BATT}$ . When the voltage across  $C_{DS}$  exceeds  $V_{BATT}$ , the synchronous P-MOSFET enters a linear mode allowing the inductor current to decrease and flowing into the SYS pin. Once  $V_{SYS}$  exceeds  $V_{BATT}$ , the P-MOSFET gate is released and normal closed-loop PWM operation is initiated. In boost mode, the battery voltage can drop to as low as 2.5V without affecting circuit operation.

### SYS Disconnect and Inrush Limiting

The MP2633 allows for true output disconnect by eliminating body diode conduction of the internal P-MOSFET rectifier.  $V_{SYS}$  can go to 0V during shutdown, drawing no current from the input source. It also allows for inrush current limiting at start-up, minimizing surge currents from the input supply. To optimize the benefits of output disconnect, avoid connecting an external Schottky diode between the SW and SYS pins. Board layout is extremely critical to minimize voltage overshoot at the SW pin due to stray inductance. Keep the output filter capacitor as close as possible to the SYS pin and use very

low ESR/ESL ceramic capacitors tied to a good ground plane.

### Boost Output Voltage

In the boost mode, the MP2633 programs the output voltage via the external resistor divider at FB pin, and provides built-in output over-voltage protection (OVP) to protect the device and other components against damage when  $V_{SYS}$  goes beyond 6V. Should output over-voltage occur, the MP2633 turns off the boost converter. Once  $V_{SYS}$  drops to a normal level, the boost converter restarts again as long as the MODE pin remains in active status.

### Boost Output-Current Limiting

The MP2633 integrates a programmable output current limit function in boost mode. If the boost output current exceeds this programmable limit threshold, the output current will be limited at this level and the SYS voltage will start to drop down. The OLIM pin programs the current limit threshold up to 1.5A as per the following equation:

$$I_{OLIM}(A) = \frac{70(k\Omega)}{R_{OLIM}(k\Omega)} \times \frac{40(mV)}{RS1(m\Omega)} \times 1.7 \quad (6)$$

Where: the 40mV is the charge current limiting reference.

### SYS Output Over Current Protection

The MP2633 integrates three-phase output over-current protection.

Phase one (boost mode): when the output current exceeds the output current limit, the

output constant current loop controls the output current, the output current remains at its limit of  $I_{OLIM}$ , and  $V_{SYS}$  decreases.

Phase two (down mode): when  $V_{SYS}$  drops below  $V_{BATT}+100mV$  and the output current loop remains in control, the boost converter enters down mode and shutdown after a 120 $\mu s$  blanking time.

Phase three (short circuit mode): when  $V_{SYS}$  drops below 2V, the boost converter shuts down immediately once the inductor current hits the fold-back peak current limit of the low side N-MOSFET. The boost converter can also recover automatically after a 1ms deglitch period.

### **Thermal Shutdown Protection**

Thermal shutdown protection is also active in boost mode. Once the junction temperature rises higher than 150°C, the MP2633 enters thermal shutdown. It will not resume normal operation until the junction temperature drops below 120°C.

## APPLICATION INFORMATION

### COMPONENT SELECTION

#### Setting the Charge Current in Charge Mode

In charge mode, both the external sense resistor, RS1, and the resistor R<sub>ISET</sub> connect to the ISET pin to set the charge current (I<sub>CHG</sub>) of the MP2633 (see the Typical Application circuit).

Given I<sub>CHG</sub> and RS1, the regulation threshold, V<sub>IREF</sub>, across this resistor is:

$$V_{IREF} \text{ (mV)} = RS1 \text{ (m}\Omega) \times I_{CHG} \text{ (A)} \quad (7)$$

R<sub>ISET</sub> sets V<sub>IREF</sub> as per the following equation:

$$V_{IREF} \text{ (mV)} = \frac{70 \text{ (k}\Omega)}{R_{ISET} \text{ (k}\Omega)} \times 40 \text{ (mV)} \quad (8)$$

So, the R<sub>ISET</sub> can be calculated as:

$$R_{ISET} \text{ (k}\Omega) = \frac{70 \text{ (k}\Omega)}{V_{IREF} \text{ (mV)}} \times 40 \text{ (mV)} \quad (9)$$

For example, for I<sub>CHG</sub>=1.5A and RS1=50mΩ: V<sub>IREF</sub>=75mV, so R<sub>ISET</sub>=37.4kΩ.

#### Setting the Input Current Limiting in Charge Mode

In charge mode, connect a resistor from the ILIM pin to AGND to program the input current limit. The relationship between the input current limit and setting resistor is:

$$R_{ILIM} = \frac{40.5}{I_{IN\_LIM} \text{ (A)}} \text{ (k}\Omega) \quad (10)$$

Where R<sub>ILIM</sub> must exceed 20kΩ so that I<sub>IN\_LIM</sub> is in the range of 0A to 2A.

For most applications, use R<sub>ILIM</sub> = 45kΩ (I<sub>USB\_LIM</sub>=900mA) for USB3.0, and use an R<sub>ILIM</sub> = 81kΩ (I<sub>USB\_LIM</sub>=500mA) for USB2.0.

#### Setting the Input Voltage Range for Different Operation Modes

A resistive voltage divider from the input voltage to PWIN pin determines the operating mode of MP2633.

$$V_{PWIN} = V_{IN} \times \frac{R6}{R4 + R6} \text{ (V)} \quad (11)$$

If the voltage on PWIN is between 0.8V and 1.15V, the MP2633 works in the charge mode. While the voltage on the PWIN pin is not in the range of 0.8V to 1.15V and V<sub>IN</sub> > 2V, the MP2633 works in the boost mode (see MPS. All Rights Reserved.).

For a wide operating range, use a maximum input voltage of 6V as the upper threshold for a voltage ratio of:

$$\frac{V_{PWIN}}{V_{IN}} = \frac{1.15}{6} = \frac{R6}{R4 + R6} \quad (12)$$

With the given R6, R4 is then:

$$R4 = \frac{V_{IN} - V_{PWIN}}{V_{PWIN}} \times R6 \quad (13)$$

For a typical application, start with R6=5.1kΩ, R4 is 21.5kΩ.

#### Setting the Input Voltage Regulation in Charge Mode

In charge mode, connect a resistor divider from the VIN pin to AGND with tapped to REG pin to program the input voltage regulation.

$$V_{IN\_R} = V_{REG} \times \frac{R3 + R5}{R5} \quad (14)$$

With the given R5, R3 is:

$$R3 = \frac{V_{IN\_R} - V_{RGE}}{V_{REG}} \times R5 \quad (15)$$

For a preset input voltage regulation value, say 4.75V, start with R5=5.1kΩ, R3 is 15kΩ.

#### NTC Function in Charge Mode

Figure 12 shows that an internal resistor divider sets the low temperature threshold (V<sub>TL</sub>) and high temperature threshold (V<sub>TH</sub>) at 65%·V<sub>SYS</sub> and 35%·V<sub>SYS</sub>, respectively. For a given NTC thermistor, select an appropriate RT1 and RT2 to set the NTC window.

$$\frac{V_{TL}}{V_{SYS}} = \frac{R_{T2} // R_{NTC\_Cold}}{R_{T1} + R_{T2} // R_{NTC\_Cold}} = TL = 65\% \quad (16)$$

$$\frac{V_{TH}}{V_{SYS}} = \frac{R_{T2} // R_{NTC\_Hot}}{R_{T1} + R_{T2} // R_{NTC\_Hot}} = TH = 35\% \quad (17)$$

Where  $R_{NTC\_Hot}$  is the value of the NTC resistor at the upper bound of its operating temperature range, and  $R_{NTC\_Cold}$  is its lower bound.

The two resistors,  $R_{T1}$  and  $R_{T2}$ , independently determine the upper and lower temperature limits. This flexibility allows the MP2633 to operate with most of NTC resistors for different temperature range requirements. Calculate  $R_{T1}$  and  $R_{T2}$  as follows:

$$R_{T1} = \frac{R_{NTC\_Hot} \times R_{NTC\_Cold} \times (TL - TH)}{TH \times TL \times (R_{NTC\_Cold} - R_{NTC\_Hot})} \quad (18)$$

$$R_{T2} = \frac{(TL - TH) \times R_{NTC\_Cold} \times R_{NTC\_Hot}}{(1 - TL) \times TH \times R_{NTC\_Cold} - (1 - TH) \times TL \times R_{NTC\_Hot}} \quad (19)$$

For example, the NCP18XH103 thermistor has the following electrical characteristic:

At 0°C,  $R_{NTC\_Cold} = 27.445k\Omega$ ;

At 50°C,  $R_{NTC\_Hot} = 4.1601k\Omega$ .

Based on equation (18) and equation (19),  $R_{T1}=6.47k\Omega$  and  $R_{T2} = 21.35k\Omega$  are suitable for an NTC window between 0°C and 50°C. Chose approximate values: e.g.,  $R_{T1}=6.49k\Omega$  and  $R_{T2}=21.5k\Omega$ .

If no external NTC is available, connect  $R_{T1}$  and  $R_{T2}$  to keep the voltage on the NTC pin within the valid NTC window: e.g.,  $R_{T1} = R_{T2} = 10k\Omega$ .

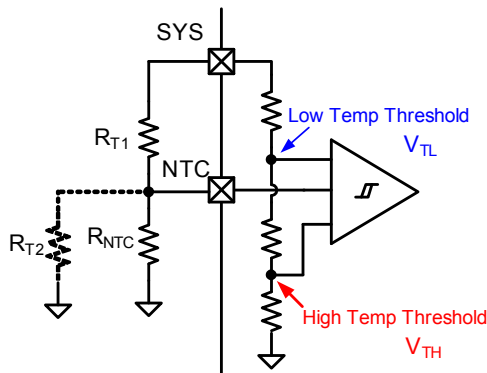

**Figure 12: NTC Function Block**

### Setting the System Voltage in Boost Mode

In the boost mode, the system voltage can be regulated to the value customer required

between 4.2V to 6V by the resistor divider at FB pin as R1 and R2 in the typical application circuit.

$$V_{SYS} = 1.2V \times \frac{R1 + R2}{R2} \quad (20)$$

Where 1.2V is the voltage reference of SYS. With a typical value for R2, 10kΩ, R1 can be determined by:

$$R1 = R2 \times \frac{V_{SYS} - 1.2V}{1.2V} (V) \quad (21)$$

For example, for a 5V system voltage, R2 is 10kΩ, and R1 is 31.6kΩ.

### Setting the Output Current Limit in Boost Mode

In boost mode, connect a resistor from the OLIM pin to AGND to program the output current limit. The relationship between the output current limit and setting resistor is as follows:

$$R_{OLIM}(k\Omega) = \frac{70(k\Omega) \times 40(mV)}{I_{OLIM}(A) \times RS1(m\Omega)} \times 1.7 \quad (22)$$

Where  $R_{OLIM}$  is greater than 63.4kΩ, so  $I_{OLIM}$  can be programmed up to 1.5A.

### Selecting the Inductor

Inductor selection trades off between cost, size, and efficiency. A lower inductance value corresponds with smaller size, but results in higher ripple currents, higher magnetic hysteretic losses, and higher output capacitances. However, a higher inductance value benefits from lower ripple current and smaller output filter capacitors, but results in higher inductor DC resistance (DCR) loss.

Choose an inductor that does not saturate under the worst-case load condition.

#### 1. Charge Mode

When MP2633 works in charge mode (as a buck converter), estimate the required inductance as:

$$L = \frac{V_{IN} - V_{BATT}}{\Delta I_{L\_MAX}} \times \frac{V_{BATT}}{V_{IN} \times f_s} \quad (23)$$

Where  $V_{IN}$ ,  $V_{BATT}$ , and  $f_s$  are the typical input

voltage, the CC charge threshold, and the switching frequency, respectively.  $\Delta I_{L\_MAX}$  is the maximum inductor ripple current, which is usually designed at 30% of the CC charge current.

With a typical 5V input voltage, 30% inductor current ripple at the corner point between trickle charge and CC charge ( $V_{BATT}=3V$ ), the inductance is  $1.85\mu H$  (for a 1.2MHz switching frequency), and  $3.7\mu H$  (for a 600kHz switching frequency).

## 2. Boost Mode

When the MP2633 is in boost mode (as a boost converter), the required inductance value is calculated as:

$$L = \frac{V_{BATT} \times (V_{SYS} - V_{BATT})}{V_{SYS} \times f_s \times \Delta I_{L\_MAX}} \quad (24)$$

$$\Delta I_{L\_MAX} = (30\% - 40\%) \times I_{BATT(MAX)} \quad (25)$$

$$I_{BATT(MAX)} = \frac{V_{SYS} \times I_{SYS}}{V_{BATT} \times \eta} \quad (26)$$

Where  $V_{BATT}$  is the minimum battery voltage,  $f_{sw}$  is the switching frequency, and  $\Delta I_{L\_MAX}$  is the peak-to-peak inductor ripple current, which is approximately 30% of the maximum battery current,  $I_{BATT(MAX)}$ .  $I_{SYS(MAX)}$  is the system current and  $\eta$  is the efficiency.

In the worst case where the battery voltage is 3V, a 30% inductor current ripple, and a typical system voltage ( $V_{SYS}=5V$ ), the inductance is  $1.8\mu H$  (for the 1.2MHz switching frequency) and  $3.6\mu H$  (for the 600kHz switching frequency) when the efficiency is 90%.

For best results, use an inductor with an inductance of  $1.8\mu H$  (for the 1.2MHz switching frequency) and  $3.6\mu H$  (for the 600kHz switching frequency) with a DC current rating that is at least 30% higher than the maximum charge current for applications. For higher efficiency, minimize the inductor's DC resistance.

## Selecting the Input Capacitor, $C_{IN}$

The input capacitor  $C_{IN}$  reduces both the surge current drawn from the input and the switching

noise from the device. The input capacitor impedance at the switching frequency should be less than the input source impedance to prevent high-frequency-switching current from passing to the input. For best results, use ceramic capacitors with X5R or X7R dielectrics because of their low ESR and small temperature coefficients. For most applications, a  $22\mu F$  capacitor will suffice.

## Selecting the System Capacitor, $C_{SYS}$

Select  $C_{SYS}$  based on the demand of the system current ripple.

### 1. Charge Mode

The capacitor  $C_{SYS}$  acts as the input capacitor of the buck converter in charge mode. The input current ripple is:

$$I_{RMS\_MAX} = I_{SYS\_MAX} \times \frac{\sqrt{V_{TC} \times (V_{IN\_MAX} - V_{TC})}}{V_{IN\_MAX}} \quad (27)$$

### 2. Boost Mode

The capacitor,  $C_{SYS}$ , is the output capacitor of boost converter.  $C_{SYS}$  keeps the system voltage ripple small and ensures feedback loop stability. The system current ripple is given by:

$$I_{RMS\_MAX} = I_{SYS\_MAX} \times \frac{\sqrt{V_{TC} \times (V_{SYS\_MAX} - V_{TC})}}{V_{SYS\_MAX}} \quad (28)$$

Since the input voltage passes to the system directly,  $V_{IN\_MAX}=V_{SYS\_MAX}$ , both charge mode and boost mode have the same system current ripple.

For  $I_{CC\_MAX}=2A$ ,  $V_{TC}=3V$ ,  $V_{IN\_MAX}=6V$ , the maximum ripple current is 1A. Select the system capacitors base on the ripple-current temperature rise not exceeding  $10^\circ C$ . For best results, use ceramic capacitors with X5R or X7R dielectrics with low ESR and small temperature coefficients. For most applications, use a  $22\mu F$  capacitor.

## Selecting the Battery Capacitor, $C_{BATT}$

$C_{BATT}$  is in parallel with the battery to absorb the high-frequency switching ripple current.

### 1. Charge Mode

The capacitor  $C_{BATT}$  is the output capacitor of the buck converter. The output voltage ripple is then:

$$\Delta r_{\text{BATT}} = \frac{\Delta V_{\text{BATT}}}{V_{\text{BATT}}} = \frac{1 - V_{\text{BATT}} / V_{\text{SYS}}}{8 \times C_{\text{BATT}} \times f_{\text{S}}^2 \times L} \quad (29)$$

## 2. Boost Mode

The capacitor  $C_{\text{BATT}}$  is the input capacitor of the boost converter. The input voltage ripple is the same as the output voltage ripple from equation (29).

Both charge mode and boost mode have the same battery voltage ripple. The capacitor  $C_{\text{BATT}}$  can be calculated as:

$$C_{\text{BATT}} = \frac{1 - V_{\text{TC}} / V_{\text{SYS\_MAX}}}{8 \times \Delta r_{\text{BATT\_MAX}} \times f_{\text{S}}^2 \times L} \quad (30)$$

To guarantee the  $\pm 0.5\%$  BATT voltage accuracy, the maximum BATT voltage ripple must not exceed 0.5% (e.g., 0.1%). The worst case occurs at the minimum battery voltage of the CC charge with the maximum input voltage.

For  $V_{\text{SYS\_MAX}}=6\text{V}$ ,  $V_{\text{CC\_MIN}}=V_{\text{TC}}=3\text{V}$ ,  $L=3.9\mu\text{H}$ ,  $f_{\text{S}}=600\text{kHz}$  or  $1.2\text{MHz}$ ,  $\Delta r_{\text{BATT\_MAX}} = 0.1\%$ ,  $C_{\text{BATT}}$  is  $22\mu\text{F}$  (for a 600kHz switching frequency) or  $10\mu\text{F}$  (for a 1.2MHz switching frequency).

A  $22\mu\text{F}$  ceramic with X5R or X7R dielectrics capacitor in parallel with a  $220\mu\text{F}$  electrolytic capacitor will suffice.

## PCB LAYOUT GUIDE

PCB layout is very important to meet specified noise, efficiency and stability requirements. The following design considerations can improve circuit performance:

1) Route the power stage adjacent to their grounds. Aim to minimize the high-side switching node (SW, inductor) trace lengths in the high-current paths and the current sense resistor trace.

Keep the switching node short and away from all small control signals, especially the feedback network.

Place the input capacitor as close as possible to the VIN and PGND pins. The local power input capacitors, connected from the SYS to PGND, must be placed as close as possible to the IC.

Place the output inductor close to the IC and connect the output capacitor between the

inductor and PGND of the IC.

2) For high-current applications, the power pads for IN, SYS, SW, BATT and PGND should be connected to as many copper planes on the board as possible. The exposed pad should connect to as many GND copper planes in the board as possible. This improves thermal performance because the board conducts heat away from the IC.

3) The PCB should have a ground plane connected directly to the return of all components through vias (e.g., two vias per capacitor for power-stage capacitors, one via per capacitor for small-signal components). If possible, add vias inside the exposed pads for the IC. A star ground design approach is typically used to keep circuit block currents isolated (power-signal/control-signal), which reduces noise-coupling and ground-bounce issues. A single ground plane for this design gives good results.

4) Place ISET, OLIM and ILIM resistors very close to their respective IC pins.

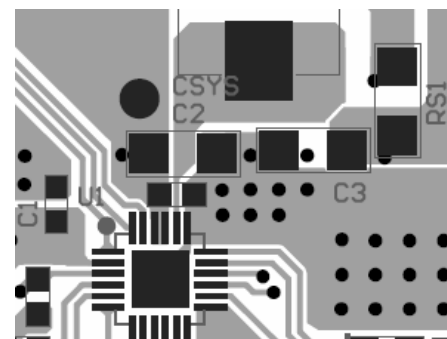

Top Layer

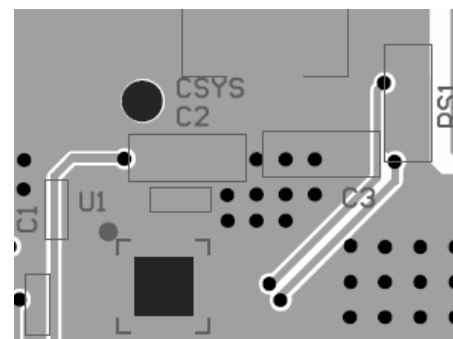

Bottom Layer

Figure 13: PCB Layout Guide

## DESIGN EXAMPLE

Below is a design example following the application guidelines for the specifications:

**Table 3: Design Example**

$V_{IN}$	5V
$V_{OUT}$	3.7V
$f_{sw}$	1200kHz

Figure14 shows the detailed application schematic. The Typical Performance Characteristics section shows the typical performance and circuit waveforms. For more possible applications of this device, please refer to the related Evaluation Board datasheets.

TYPICAL APPLICATION CIRCUITS

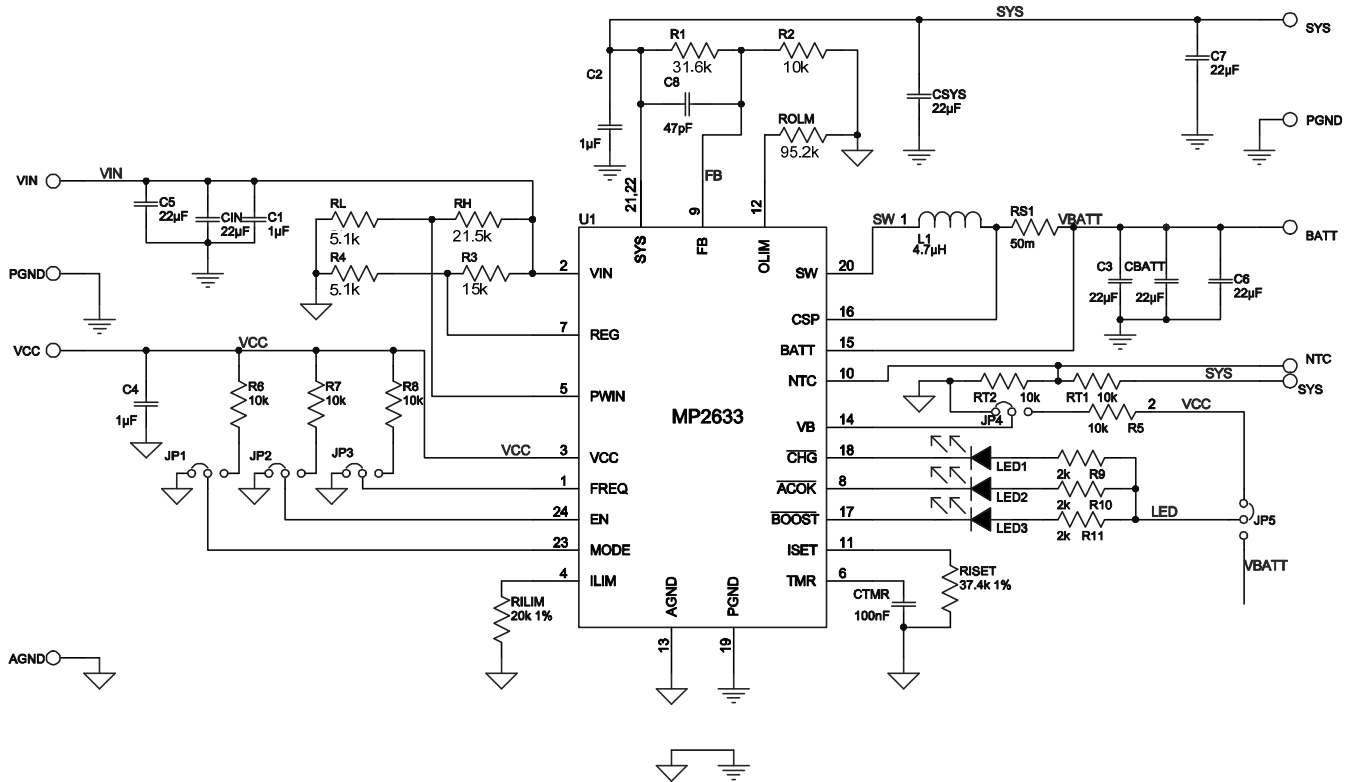
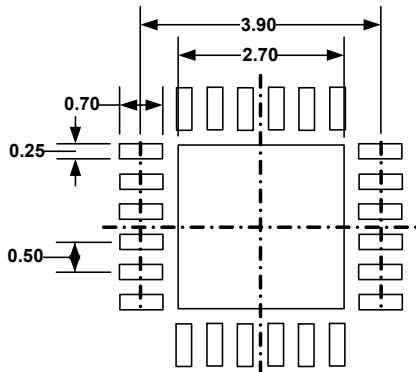
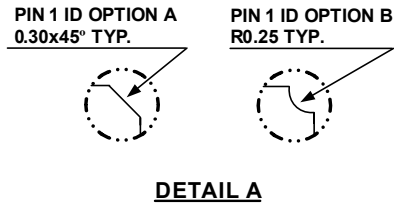
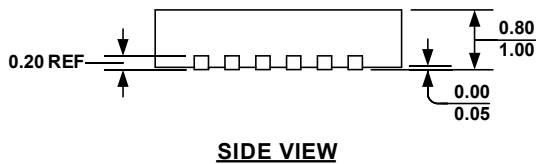
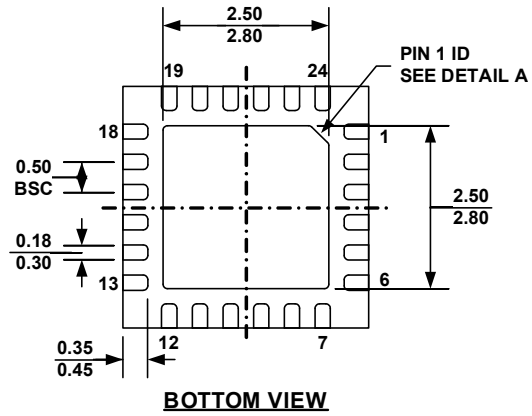
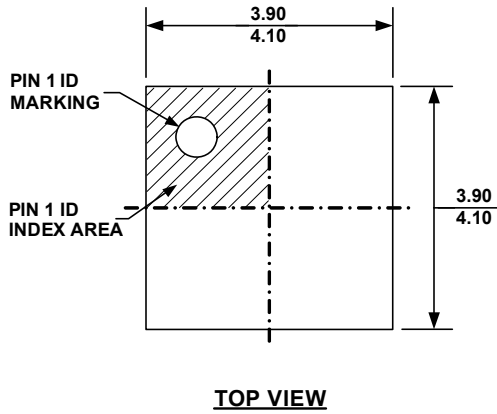

Figure14: Detailed Application Circuit



### PACKAGE INFORMATION

#### QFN24 (4x4mm)



**NOTE:**

- 1) ALL DIMENSIONS ARE IN MILLIMETERS
- 2) EXPOSED PADDLE SIZE DOES NOT INCLUDE MOLD FLASH
- 3) LEAD COPLANARITY SHALL BE 0.10 MILLIMETER MAX
- 4) DRAWING CONFIRMS TO JEDEC MO220, VARIATION VGGD.
- 5) DRAWING IS NOT TO SCALE

**NOTICE:** The information in this document is subject to change without notice. Users should warrant and guarantee that third party Intellectual Property rights are not infringed upon when integrating MPS products into any application. MPS will not assume any legal responsibility for any said applications.

Компания «Океан Электроники» предлагает заключение долгосрочных отношений при поставках импортных электронных компонентов на взаимовыгодных условиях!

Наши преимущества:

- Поставка оригинальных импортных электронных компонентов напрямую с производств Америки, Европы и Азии, а так же с крупнейших складов мира;
- Широкая линейка поставок активных и пассивных импортных электронных компонентов (более 30 млн. наименований);
- Поставка сложных, дефицитных, либо снятых с производства позиций;
- Оперативные сроки поставки под заказ (от 5 рабочих дней);
- Экспресс доставка в любую точку России;
- Помощь Конструкторского Отдела и консультации квалифицированных инженеров;
- Техническая поддержка проекта, помощь в подборе аналогов, поставка прототипов;
- Поставка электронных компонентов под контролем ВП;
- Система менеджмента качества сертифицирована по Международному стандарту ISO 9001;
- При необходимости вся продукция военного и аэрокосмического назначения проходит испытания и сертификацию в лаборатории (по согласованию с заказчиком);
- Поставка специализированных компонентов военного и аэрокосмического уровня качества (Xilinx, Altera, Analog Devices, Intersil, Interpoint, Microsemi, Actel, Aeroflex, Peregrine, VPT, Syfer, Eurofarad, Texas Instruments, MS Kennedy, Miteq, Cobham, E2V, MA-COM, Hittite, Mini-Circuits, General Dynamics и др.);

Компания «Океан Электроники» является официальным дистрибьютором и эксклюзивным представителем в России одного из крупнейших производителей разъемов военного и аэрокосмического назначения «JONHON», а так же официальным дистрибьютором и эксклюзивным представителем в России производителя высокотехнологичных и надежных решений для передачи СВЧ сигналов «FORSTAR».



## JONHON

«JONHON» (основан в 1970 г.)

Разъемы специального, военного и аэрокосмического назначения:

(Применяются в военной, авиационной, аэрокосмической, морской, железнодорожной, горно- и нефтедобывающей отраслях промышленности)

«FORSTAR» (основан в 1998 г.)

ВЧ соединители, коаксиальные кабели, кабельные сборки и микроволновые компоненты:

(Применяются в телекоммуникациях гражданского и специального назначения, в средствах связи, РЛС, а так же военной, авиационной и аэрокосмической отраслях промышленности).



Телефон: 8 (812) 309-75-97 (многоканальный)

Факс: 8 (812) 320-03-32

Электронная почта: [ocean@oceanchips.ru](mailto:ocean@oceanchips.ru)

Web: <http://oceanchips.ru/>

Адрес: 198099, г. Санкт-Петербург, ул. Калинина, д. 2, корп. 4, лит. А