150mA LDO REGULATOR

NO.EA-105-0606

OUTLINE

The R1180x Series are CMOS-based voltage regulator ICs with high output voltage accuracy, extremely low supply current, and low ON-resistance. Each of these ICs consists of a voltage reference unit, an error amplifier, resistor-net for voltage setting, a current limit circuit which prevents the destruction by excess current, and so on. The output voltage of these ICs is fixed with high accuracy. B version has a chip enable pin, therefore ultra-low consumption current standby mode can be realized with the pin.

Since the packages for these ICs are SOT-23-5 (R1180N Series), SC-82AB (R1180Q Series), and SON1612-6 (R1180D Series), therefore high density mounting of the ICs on boards is possible.

FEATURES

- Low Supply Current Typ. 1 μ A(Except the current through CE pull-down circuit)
- Standby Mode Typ. 0.1 μ A
- Low Dropout Voltage..... Typ. 0.25V ($I_{OUT}=150\text{mA}$ 3.0V Output type)
- Low Temperature-Drift Coefficient of Output Voltage Typ. $\pm 100\text{ppm}/^\circ\text{C}$
- Good Line Regulation Typ. 0.05%/V
- High Output Voltage Accuracy $\pm 2.0\%$
- Small Packages SOT-23-5 (R1180N), SC-82AB (R1180Q),
SON1612-6 (R1180D)
- Output Voltage 1.2V to 3.6V
- Built-in Fold Back Protection Circuit Typ. 40mA (Current at short mode)
- Ceramic capacitors are recommended to be used with this IC 0.1 μ F

APPLICATIONS

- Stable voltage reference.
- Power source for electrical appliances such as cameras, VCRs and camcorders.
- Power source for battery-powered equipment.

BLOCK DIAGRAMS



SELECTION GUIDE

The output voltage, version, and the taping type for the ICs can be selected at the user's request. The selection can be made with designating the part number as shown below:

R1180xxx1x-TR-x ← Part Number
 ↑ ↑ ↑ ↑ ↑
 a b c d e

Code	Contents
a	Designation of Package Type : N: SOT-23-5 (Mini mold) Q: SC-82AB (Super-mini mold) D: SON1612-6
b	Setting Output Voltage (V_{OUT}) : Stepwise setting with a step of 0.1V in the range of 1.2V to 3.6V is possible.
c	Designation of Active Type : B: active high type C: without chip enable circuit
d	Designation of Taping Type : Ex. TR (refer to Taping Specifications; TR type is the standard direction.)
e	Designation of composition of pin plating: -F: Lead free plating (SOT-23-5, SC-82AB, SON1612-6)

PIN CONFIGURATION



PIN DESCRIPTIONS

● SOT-23-5 (R1180N)

Pin No	Symbol	Pin Description
1	V _{DD}	Input Pin
2	GND	Ground Pin
3	CE or NC	Chip Enable Pin or No Connection
4	NC	No Connection
5	V _{OUT}	Output pin

● SC-82AB (R1180Q)

Pin No	Symbol	Pin Description
1	CE or NC	Chip Enable Pin or No Connection
2	GND	Ground Pin
3	V _{OUT}	Output pin
4	V _{DD}	Input Pin

● SON1612-6 (R1180D)

Pin No	Symbol	Pin Description
1	V _{DD}	Input Pin
2	GND	Ground Pin
3	V _{OUT}	Output pin
4	NC	No Connection
5	GND	Ground Pin
6	CE or NC	Chip Enable Pin or No Connection

ABSOLUTE MAXIMUM RATINGS

Symbol	Item	Rating	Unit
V_{IN}	Input Voltage	6.5	V
V_{CE}	Input Voltage(CE Pin)	6.5	V
V_{OUT}	Output Voltage	-0.3 to $V_{IN}+0.3$	V
I_{OUT}	Output Current	180	mA
	Power Dissipation (SOT23-5) * ¹	420	
	Power Dissipation (SC82-AB)* ¹	380	
	Power Dissipation (SON1612-6) * ¹	500	
T_{opt}	Operating Temperature Range	-40 to 85	°C
T_{stg}	Storage Temperature Range	-55 to 125	°C

*¹ For Power Dissipation, please refer to PACKAGE INFORMATION to be described.

ELECTRICAL CHARACTERISTICS

• R1180xxx1B/C

T_{opt}=25°C

Symbol	Item	Conditions	Min.	Typ.	Max.	Unit
V _{OUT}	Output Voltage	V _{IN} =Set V _{OUT} +1V 1μA ≤ I _{OUT} ≤ 30mA	×0.980		×1.020	V
I _{OUT}	Output Current	V _{IN} -V _{OUT} =1.0V	150			mA
ΔV _{OUT} /ΔI _{OUT}	Load Regulation	V _{IN} =Set V _{OUT} +1V 1μA ≤ I _{OUT} ≤ 150mA		20	40	mV
V _{DIF}	Dropout Voltage	Refer to the ELECTRICAL CHARACTERISTICS by OUTPUT VOLTAGE				
I _{SS}	Supply Current	V _{IN} =Set V _{OUT} +1V, I _{OUT} =0mA		1.0	1.5	μA
I _{standby}	Supply Current (Standby)	V _{IN} =Set V _{OUT} +1V V _{CE} =GND (B version)		0.1	1.0	μA
ΔV _{OUT} /ΔV _{IN}	Line Regulation	Set V _{OUT} +0.5V ≤ V _{IN} ≤ 6.0V I _{OUT} =30mA		0.05	0.20	%/V
V _{IN}	Input Voltage		1.7		6.0	V
ΔV _{OUT} /ΔT	Output Voltage Temperature Coefficient	I _{OUT} =30mA -40°C ≤ T _{opt} ≤ 85°C		±100		ppm/°C
I _{lim}	Short Current Limit	V _{OUT} =0V		40		mA
I _{PD}	CE Pull-down Constant Current	(R1180xxx1B)		0.35		μA
V _{CEH}	CE Input Voltage "H"	(R1180xxx1B)	1.2		6.0	V
V _{CEL}	CE Input Voltage "L"	(R1180xxx1B)	0.0		0.3	V

• ELECTRICAL CHARACTERISTICS by OUTPUT VOLTAGE

T_{opt} = 25°C

Output Voltage V _{OUT} (V)	Dropout Voltage V _{DIF} (V)		
	Condition	Typ.	Max.
1.2 ≤ V _{OUT} < 1.3	I _{OUT} = 150mA	0.85	1.20
1.3 ≤ V _{OUT} < 1.4		0.75	1.10
1.4 ≤ V _{OUT} < 1.5		0.65	1.00
1.5 ≤ V _{OUT} < 1.7		0.60	0.90
1.7 ≤ V _{OUT} < 1.9		0.50	0.75
1.9 ≤ V _{OUT} < 2.1		0.40	0.65
2.1 ≤ V _{OUT} < 2.8		0.35	0.55
2.8 ≤ V _{OUT} ≤ 3.6		0.25	0.40

TYPICAL CHARACTERISTICS

1) Output Voltage vs. Output Current (T_{opt}=25°C)



2) Output Voltage vs. Input Voltage (T_{opt}=25°C)



R1180x361x



3) Dropout Voltage vs. Output Current

R1180x121x



R1180x281x



R1180x361x



R1180x

4) Output Voltage vs. Temperature ($I_{OUT}=30mA$)

R1180x121x ($V_{IN}=2.2V$)



R1180x281x ($V_{IN}=3.8V$)



R1180x361x ($V_{IN}=4.6V$)



5) Supply Current vs. Input Voltage ($T_{opt}=25^{\circ}C$)

R1180x121x

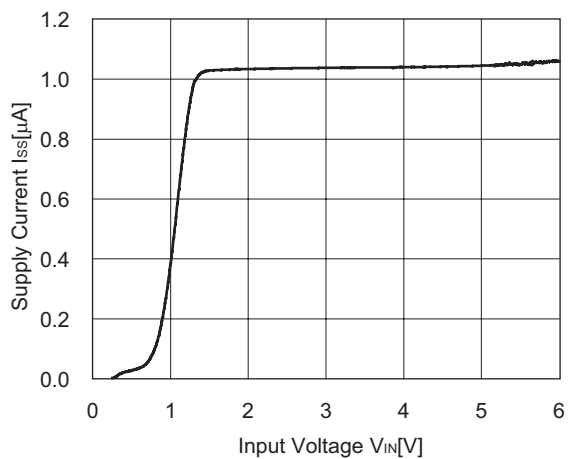

R1180x281x

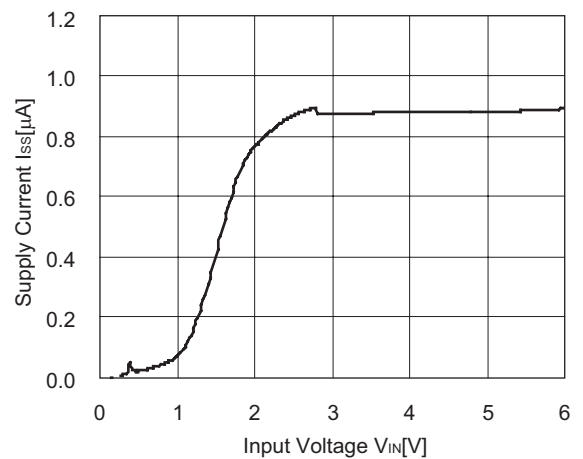

R1180x361x

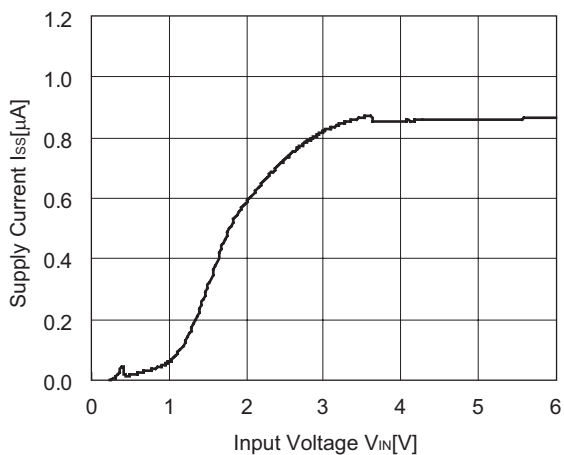

6) Supply Current vs. Temperature

R1180x121x ($V_{IN}=2.2V$)

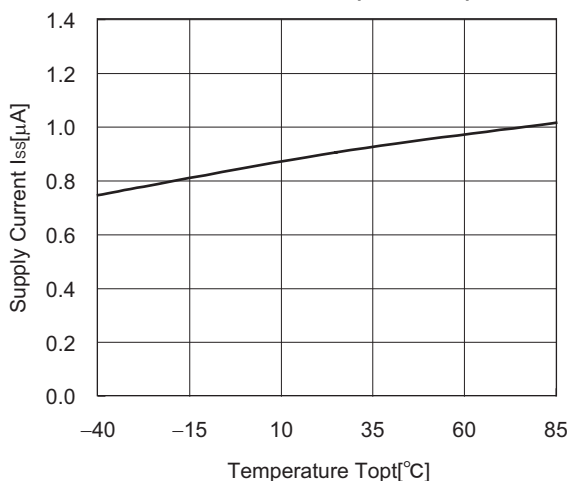

R1180x281x ($V_{IN}=3.8V$)



R1180x361x ($V_{IN}=4.6V$)

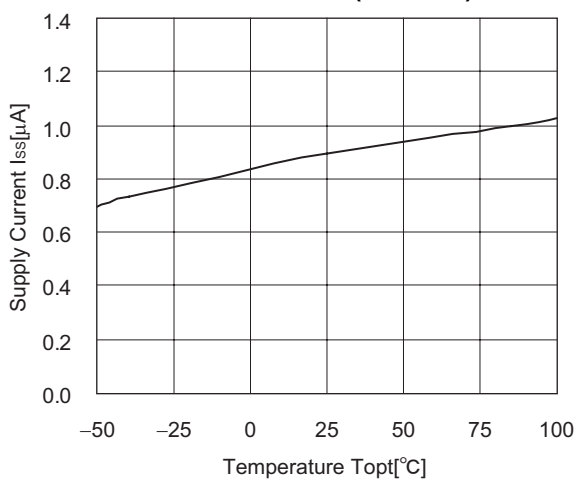

R1180x

7) Dropout Voltage vs. Set Output Voltage ($T_{opt}=25^{\circ}\text{C}$)



8) Ripple Rejection vs. Frequency ($C_{IN}=\text{none}$)

R1180x121x

$V_{IN}=2.4V_{DC}+0.5p-p$
 $C_{OUT}=\text{Ceramic } 0.1\mu\text{F}$



R1180x121x

$V_{IN}=2.4V_{DC}+0.5p-p$
 $C_{OUT}=\text{Ceramic } 1\mu\text{F}$



R1180x281x

$V_{IN}=3.8V_{DC}+0.5p-p$
 $C_{OUT}=\text{Ceramic } 0.1\mu\text{F}$



R1180x281x

$V_{IN}=3.8V_{DC}+0.5p-p$
 $C_{OUT}=\text{Ceramic } 1\mu\text{F}$





9) Ripple Rejection vs. Input Bias Voltage ($T_{opt}=25^{\circ}C$, $C_{IN}=\text{none}$, $C_{OUT}=\text{ceramic } 0.1\mu F$)

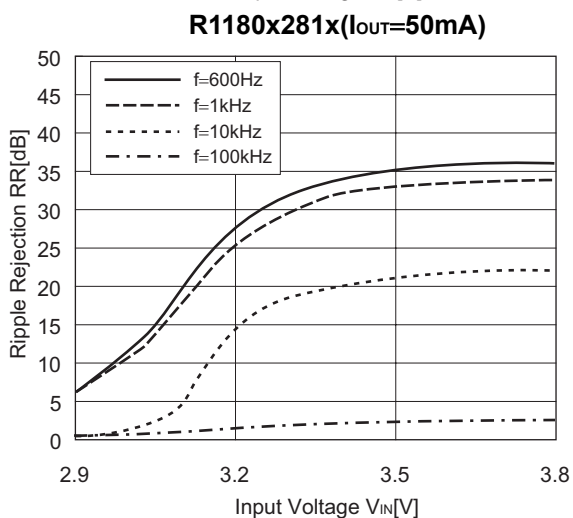

10) Input Transient Response ($C_{IN}=none, tr=tf=5\mu s$)

R1180x281x



R1180x281x



R1180x281x



R1180x281x



11) Load Transient Response ($t_r=t_f=0.5\mu\text{s}$ $V_{IN}=3.8\text{V}$)

R1180x281x



R1180x281x



R1180x281x



R1180x281x



R1180x281x



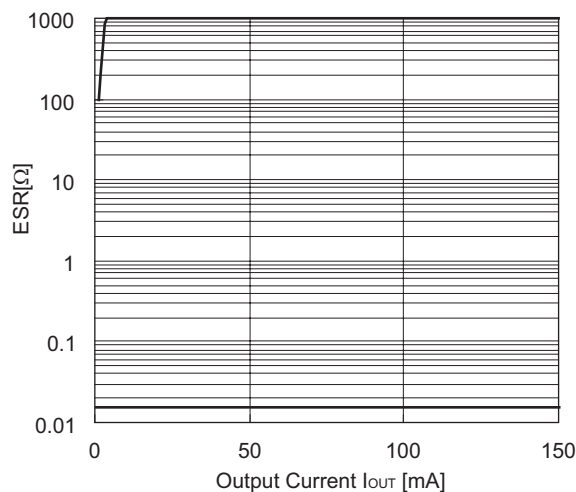

12) ESR vs. Output Current

R1180x121x($C_{IN} = \text{Ceramic } 1.0\mu\text{A}$, $C_{OUT} = \text{Ceramic } 0.1\mu\text{F}$)**R1180x281x**($C_{IN} = \text{Ceramic } 1.0\mu\text{A}$, $C_{OUT} = \text{Ceramic } 0.1\mu\text{F}$)

The relations between I_{OUT} (Output Current) and ESR of an output capacitor are shown above. The conditions when the white noise level is under $40\mu\text{V}$ (Avg.) are marked as the hatched area in the graph.

<Measurement conditions>

- (1) $V_{IN} = V_{OUT} + 1V$
- (2) Frequency Band: 10Hz to 2MHz (BW=30Hz)
- (3) Temperature: -40°C to 85°C

- SOT-23-5 (SC-74A)

Unit: mm

PACKAGE DIMENSIONS



TAPING SPECIFICATION



TAPING REEL DIMENSIONS

(1reel=3000pcs)



POWER DISSIPATION (SOT-23-5)

This specification is at mounted on board. Power Dissipation (P_D) depends on conditions of mounting on board. This specification is based on the measurement at the condition below:

(Power Dissipation (SOT-23-5) is substitution of SOT-23-6.)

Measurement Conditions

	Standard Land Pattern
Environment	Mounting on Board (Wind velocity=0m/s)
Board Material	Glass cloth epoxy plactic (Double sided)
Board Dimensions	40mm × 40mm × 1.6mm
Copper Ratio	Top side : Approx. 50% , Back side : Approx. 50%
Through-hole	φ0.5mm × 44pcs

Measurement Result

($T_{opt}=25^{\circ}C, T_{jmax}=125^{\circ}C$)

	Standard Land Pattern	Free Air
Power Dissipation	420mW	250mW
Thermal Resistance	$\theta_{ja}=(125-25^{\circ}C)/0.42W=263^{\circ}C/W$	400 $^{\circ}C/W$

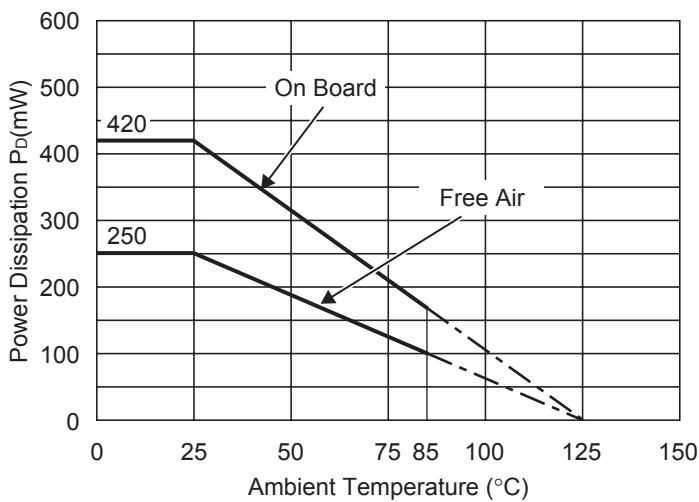

Power Dissipation



Measurement Board Pattern

○ IC Mount Area Unit : mm

RECOMMENDED LAND PATTERN



• SC-82AB

Unit: mm

PACKAGE DIMENSIONS



TAPING SPECIFICATION

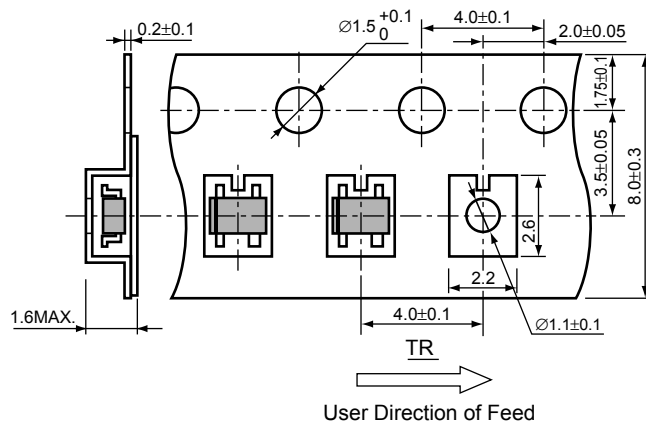

TAPING REEL DIMENSIONS

(1reel=3000pcs)



POWER DISSIPATION (SC-82AB)

This specification is at mounted on board. Power Dissipation (P_D) depends on conditions of mounting on board. This specification is based on the measurement at the condition below:

Measurement Conditions

	Standard Land Pattern
Environment	Mounting on Board (Wind velocity=0m/s)
Board Material	Glass cloth epoxy plactic (Double sided)
Board Dimensions	40mm × 40mm × 1.6mm
Copper Ratio	Top side : Approx. 50% , Back side : Approx. 50%
Through-hole	φ0.5mm × 44pcs

Measurement Result

($T_{opt}=25^{\circ}C, T_{jmax}=125^{\circ}C$)

	Standard Land Pattern	Free Air
Power Dissipation	380mW	150mW
Thermal Resistance	$\theta_{ja}=(125-25^{\circ}C)/0.38W=263^{\circ}C/W$	667 $^{\circ}C/W$



Power Dissipation



Measurement Board Pattern

○ IC Mount Area (Unit : mm)

RECOMMENDED LAND PATTERN



(Unit: mm)

Power Dissipation (SON1612-6)

This specification is at mounted on board.

Power Dissipation (P_D) depends on conditions of mounting on board. This specification is based on the measurement at the condition below:

Measurement Conditions

	Standard Land Pattern
Environment	Mounting on Board (Wind velocity=0m/s)
Board Material	Glass cloth epoxy plastic (Double sided)
Board Dimensions	40mm × 40mm × 1.6mm
Copper Ratio	Top side : Approx. 50%, Back side : Approx.50%
Through-hole	φ0.5mm × 24pcs

Measurement Result

($T_{opt}=25^{\circ}C, T_{jmax}=125^{\circ}C$)

	Standard Land Pattern
Power Dissipation	500mW
Thermal Resistance	$\theta_{ja}=(125-25^{\circ}C)/0.5W=200^{\circ}C/W$



Power Dissipation

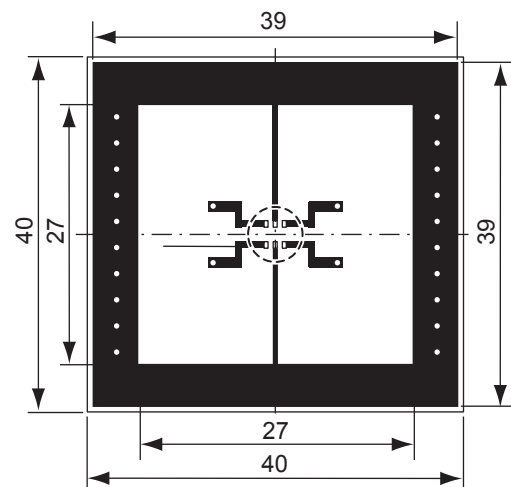

Measurement Board Pattern

○ IC Mount Area Unit : mm

RECOMMENDED LAND PATTERN



(Unit: mm)

R1180N SERIES MARK SPECIFICATION

● **SOT-23-5 (SC-74A)**

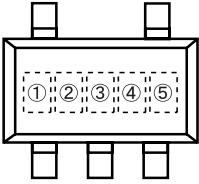

①, ②, ③ : Product Code (refer to Part Number vs. Product Code)

④, ⑤ : Lot Number

● **Part Number vs. Product Code**

Part Number	Product Code		
	①	②	③
R1180N121B	C	1	2
R1180N131B	C	1	3
R1180N141B	C	1	4
R1180N151B	C	1	5
R1180N161B	C	1	6
R1180N171B	C	1	7
R1180N181B	C	1	8
R1180N191B	C	1	9
R1180N201B	C	2	0
R1180N211B	C	2	1
R1180N221B	C	2	2
R1180N231B	C	2	3
R1180N241B	C	2	4
R1180N251B	C	2	5
R1180N261B	C	2	6
R1180N271B	C	2	7
R1180N281B	C	2	8
R1180N291B	C	2	9
R1180N301B	C	3	0
R1180N311B	C	3	1
R1180N321B	C	3	2
R1180N331B	C	3	3
R1180N341B	C	3	4
R1180N351B	C	3	5
R1180N361B	C	3	6

Part Number	Product Code		
	①	②	③
R1180N121C	D	1	2
R1180N131C	D	1	3
R1180N141C	D	1	4
R1180N151C	D	1	5
R1180N161C	D	1	6
R1180N171C	D	2	7
R1180N181C	D	2	8
R1180N191C	D	2	9
R1180N201C	D	2	0
R1180N211C	D	2	1
R1180N221C	D	2	2
R1180N231C	D	2	3
R1180N241C	D	2	4
R1180N251C	D	2	5
R1180N261C	D	2	6
R1180N271C	D	3	7
R1180N281C	D	3	8
R1180N291C	D	3	9
R1180N301C	D	3	0
R1180N311C	D	3	1
R1180N321C	D	3	2
R1180N331C	D	3	3
R1180N341C	D	3	4
R1180N351C	D	3	5
R1180N361C	D	3	6

R1180Q SERIES MARK SPECIFICATION

• SC-82AB



①, ② : Product Code (refer to Part Number vs. Product Code)

③, ④ : Lot Number

• Part Number vs. Product Code

Part Number	Product Code	
	①	②
R1180Q121B	A	2
R1180Q131B	A	3
R1180Q141B	A	4
R1180Q151B	A	5
R1180Q161B	A	6
R1180Q171B	A	7
R1180Q181B	A	8
R1180Q191B	A	9
R1180Q201B	B	0
R1180Q211B	B	1
R1180Q221B	B	2
R1180Q231B	B	3
R1180Q241B	B	4
R1180Q251B	B	5
R1180Q261B	B	6
R1180Q271B	B	7
R1180Q281B	B	8
R1180Q291B	B	9
R1180Q301B	C	0
R1180Q311B	C	1
R1180Q321B	C	2
R1180Q331B	C	3
R1180Q341B	C	4
R1180Q351B	C	5
R1180Q361B	C	6

Part Number	Product Code	
	①	②
R1180Q121C	D	2
R1180Q131C	D	3
R1180Q141C	D	4
R1180Q151C	D	5
R1180Q161C	D	6
R1180Q171C	D	7
R1180Q181C	D	8
R1180Q191C	D	9
R1180Q201C	E	0
R1180Q211C	E	1
R1180Q221C	E	2
R1180Q231C	E	3
R1180Q241C	E	4
R1180Q251C	E	5
R1180Q261C	E	6
R1180Q271C	E	7
R1180Q281C	E	8
R1180Q291C	E	9
R1180Q301C	F	0
R1180Q311C	F	1
R1180Q321C	F	2
R1180Q331C	F	3
R1180Q341C	F	4
R1180Q351C	F	5
R1180Q361C	F	6

R1180D SERIES MARK SPECIFICATION

● SON1612-6



①~④ : Product Code (refer to Part Number vs. Product Code)

⑤, ⑥ : Lot Number

● Part Number vs. Product Code

Part Number	Product Code			
	①	②	③	④
R1180D121B	G	1	2	B
R1180D131B	G	1	3	B
R1180D141B	G	1	4	B
R1180D151B	G	1	5	B
R1180D161B	G	1	6	B
R1180D171B	G	1	7	B
R1180D181B	G	1	8	B
R1180D191B	G	1	9	B
R1180D201B	G	2	0	B
R1180D211B	G	2	1	B
R1180D221B	G	2	2	B
R1180D231B	G	2	3	B
R1180D241B	G	2	4	B
R1180D251B	G	2	5	B
R1180D261B	G	2	6	B
R1180D271B	G	2	7	B
R1180D281B	G	2	8	B
R1180D291B	G	2	9	B
R1180D301B	G	3	0	B
R1180D311B	G	3	1	B
R1180D321B	G	3	2	B
R1180D331B	G	3	3	B
R1180D341B	G	3	4	B
R1180D351B	G	3	5	B
R1180D361B	G	3	6	B
R1180D181B5	G	0	0	B

Part Number	Product Code			
	①	②	③	④
R1180D121C	G	1	2	C
R1180D131C	G	1	3	C
R1180D141C	G	1	4	C
R1180D151C	G	1	5	C
R1180D161C	G	1	6	C
R1180D171C	G	1	7	C
R1180D181C	G	1	8	C
R1180D191C	G	1	9	C
R1180D201C	G	2	0	C
R1180D211C	G	2	1	C
R1180D221C	G	2	2	C
R1180D231C	G	2	3	C
R1180D241C	G	2	4	C
R1180D251C	G	2	5	C
R1180D261C	G	2	6	C
R1180D271C	G	2	7	C
R1180D281C	G	2	8	C
R1180D291C	G	2	9	C
R1180D301C	G	3	0	C
R1180D311C	G	3	1	C
R1180D321C	G	3	2	C
R1180D331C	G	3	3	C
R1180D341C	G	3	4	C
R1180D351C	G	3	5	C
R1180D361C	G	3	6	C

Компания «Океан Электроники» предлагает заключение долгосрочных отношений при поставках импортных электронных компонентов на взаимовыгодных условиях!

Наши преимущества:

- Поставка оригинальных импортных электронных компонентов напрямую с производств Америки, Европы и Азии, а так же с крупнейших складов мира;
- Широкая линейка поставок активных и пассивных импортных электронных компонентов (более 30 млн. наименований);
- Поставка сложных, дефицитных, либо снятых с производства позиций;
- Оперативные сроки поставки под заказ (от 5 рабочих дней);
- Экспресс доставка в любую точку России;
- Помощь Конструкторского Отдела и консультации квалифицированных инженеров;
- Техническая поддержка проекта, помощь в подборе аналогов, поставка прототипов;
- Поставка электронных компонентов под контролем ВП;
- Система менеджмента качества сертифицирована по Международному стандарту ISO 9001;
- При необходимости вся продукция военного и аэрокосмического назначения проходит испытания и сертификацию в лаборатории (по согласованию с заказчиком);
- Поставка специализированных компонентов военного и аэрокосмического уровня качества (Xilinx, Altera, Analog Devices, Intersil, Interpoint, Microsemi, Actel, Aeroflex, Peregrine, VPT, Syfer, Eurofarad, Texas Instruments, MS Kennedy, Miteq, Cobham, E2V, MA-COM, Hittite, Mini-Circuits, General Dynamics и др.);

Компания «Океан Электроники» является официальным дистрибьютором и эксклюзивным представителем в России одного из крупнейших производителей разъемов военного и аэрокосмического назначения «JONHON», а так же официальным дистрибьютором и эксклюзивным представителем в России производителя высокотехнологичных и надежных решений для передачи СВЧ сигналов «FORSTAR».



JONHON

«JONHON» (основан в 1970 г.)

Разъемы специального, военного и аэрокосмического назначения:

(Применяются в военной, авиационной, аэрокосмической, морской, железнодорожной, горно- и нефтедобывающей отраслях промышленности)

«FORSTAR» (основан в 1998 г.)

ВЧ соединители, коаксиальные кабели, кабельные сборки и микроволновые компоненты:

(Применяются в телекоммуникациях гражданского и специального назначения, в средствах связи, РЛС, а так же военной, авиационной и аэрокосмической отраслях промышленности).



Телефон: 8 (812) 309-75-97 (многоканальный)

Факс: 8 (812) 320-03-32

Электронная почта: ocean@oceanchips.ru

Web: <http://oceanchips.ru/>

Адрес: 198099, г. Санкт-Петербург, ул. Калинина, д. 2, корп. 4, лит. А