150mA LDO REGULATOR

NO.EA-105-0606

OUTLINE

The R1180x Series are CMOS-based voltage regulator ICs with high output voltage accuracy, extremely low supply current, and low ON-resistance. Each of these ICs consists of a voltage reference unit, an error amplifier, resistor-net for voltage setting, a current limit circuit which prevents the destruction by excess current, and so on. The output voltage of these ICs is fixed with high accuracy. B version has a chip enable pin, therefore ultra-low consumption current standby mode can be realized with the pin.

Since the packages for these ICs are SOT-23-5 (R1180N Series), SC-82AB (R1180Q Series), and SON1612-6 (R1180D Series), therefore high density mounting of the ICs on boards is possible.

FEATURES

- Low Supply Current Typ. 1 μ A(Except the current through CE pull-down circuit)
- Standby Mode Typ. 0.1 μ A
- Low Dropout Voltage..... Typ. 0.25V ($I_{OUT}=150$ mA 3.0V Output type)
- Low Temperature-Drift Coefficient of Output Voltage Typ. ± 100 ppm/ $^{\circ}$ C
- Good Line Regulation Typ. 0.05%/V
- High Output Voltage Accuracy $\pm 2.0\%$
- Small Packages SOT-23-5 (R1180N), SC-82AB (R1180Q),
SON1612-6 (R1180D)
- Output Voltage 1.2V to 3.6V
- Built-in Fold Back Protection Circuit Typ. 40mA (Current at short mode)
- Ceramic capacitors are recommended to be used with this IC 0.1 μ F

APPLICATIONS

- Stable voltage reference.
- Power source for electrical appliances such as cameras, VCRs and camcorders.
- Power source for battery-powered equipment.

BLOCK DIAGRAMS



SELECTION GUIDE

The output voltage, version, and the taping type for the ICs can be selected at the user's request. The selection can be made with designating the part number as shown below:

R1180xxx1x-TR-x ← Part Number
 ↑ ↑ ↑ ↑ ↑
 a b c d e

| Code | Contents |
|------|--|
| a | Designation of Package Type : N: SOT-23-5 (Mini mold) Q: SC-82AB (Super-mini mold) D: SON1612-6 |
| b | Setting Output Voltage (V_{OUT}) : Stepwise setting with a step of 0.1V in the range of 1.2V to 3.6V is possible. |
| c | Designation of Active Type : B: active high type C: without chip enable circuit |
| d | Designation of Taping Type : Ex. TR (refer to Taping Specifications; TR type is the standard direction.) |
| e | Designation of composition of pin plating: -F: Lead free plating (SOT-23-5, SC-82AB, SON1612-6) |

PIN CONFIGURATION



PIN DESCRIPTIONS

● SOT-23-5 (R1180N)

| Pin No | Symbol | Pin Description |
|--------|-----------|----------------------------------|
| 1 | V_{DD} | Input Pin |
| 2 | GND | Ground Pin |
| 3 | CE or NC | Chip Enable Pin or No Connection |
| 4 | NC | No Connection |
| 5 | V_{OUT} | Output pin |

● SC-82AB (R1180Q)

| Pin No | Symbol | Pin Description |
|--------|-----------|----------------------------------|
| 1 | CE or NC | Chip Enable Pin or No Connection |
| 2 | GND | Ground Pin |
| 3 | V_{OUT} | Output pin |
| 4 | V_{DD} | Input Pin |

● SON1612-6 (R1180D)

| Pin No | Symbol | Pin Description |
|--------|-----------|----------------------------------|
| 1 | V_{DD} | Input Pin |
| 2 | GND | Ground Pin |
| 3 | V_{OUT} | Output pin |
| 4 | NC | No Connection |
| 5 | GND | Ground Pin |
| 6 | CE or NC | Chip Enable Pin or No Connection |

ABSOLUTE MAXIMUM RATINGS

| Symbol | Item | Rating | Unit |
|-----------|--|----------------------|------|
| V_{IN} | Input Voltage | 6.5 | V |
| V_{CE} | Input Voltage(CE Pin) | 6.5 | V |
| V_{OUT} | Output Voltage | -0.3 to $V_{IN}+0.3$ | V |
| I_{OUT} | Output Current | 180 | mA |
| | Power Dissipation (SOT23-5) * ¹ | 420 | |
| | Power Dissipation (SC82-AB)* ¹ | 380 | |
| | Power Dissipation (SON1612-6) * ¹ | 500 | |
| T_{opt} | Operating Temperature Range | -40 to 85 | °C |
| T_{stg} | Storage Temperature Range | -55 to 125 | °C |

*¹ For Power Dissipation, please refer to PACKAGE INFORMATION to be described.

ELECTRICAL CHARACTERISTICS

• R1180xxx1B/C

T_{opt}=25°C

| Symbol | Item | Conditions | Min. | Typ. | Max. | Unit |
|--------------------------------------|--|---|--------|------|--------|--------|
| V _{OUT} | Output Voltage | V _{IN} =Set V _{OUT} +1V 1μA ≤ I _{OUT} ≤ 30mA | ×0.980 | | ×1.020 | V |
| I _{OUT} | Output Current | V _{IN} -V _{OUT} =1.0V | 150 | | | mA |
| ΔV _{OUT} /ΔI _{OUT} | Load Regulation | V _{IN} =Set V _{OUT} +1V 1μA ≤ I _{OUT} ≤ 150mA | | 20 | 40 | mV |
| V _{DIF} | Dropout Voltage | Refer to the ELECTRICAL CHARACTERISTICS by OUTPUT VOLTAGE | | | | |
| I _{SS} | Supply Current | V _{IN} =Set V _{OUT} +1V, I _{OUT} =0mA | | 1.0 | 1.5 | μA |
| I _{standby} | Supply Current (Standby) | V _{IN} =Set V _{OUT} +1V V _{CE} =GND (B version) | | 0.1 | 1.0 | μA |
| ΔV _{OUT} /ΔV _{IN} | Line Regulation | Set V _{OUT} +0.5V ≤ V _{IN} ≤ 6.0V I _{OUT} =30mA | | 0.05 | 0.20 | %/V |
| V _{IN} | Input Voltage | | 1.7 | | 6.0 | V |
| ΔV _{OUT} /ΔT | Output Voltage Temperature Coefficient | I _{OUT} =30mA -40°C ≤ T _{opt} ≤ 85°C | | ±100 | | ppm/°C |
| I _{lim} | Short Current Limit | V _{OUT} =0V | | 40 | | mA |
| I _{PD} | CE Pull-down Constant Current | (R1180xxx1B) | | 0.35 | | μA |
| V _{CEH} | CE Input Voltage "H" | (R1180xxx1B) | 1.2 | | 6.0 | V |
| V _{CEL} | CE Input Voltage "L" | (R1180xxx1B) | 0.0 | | 0.3 | V |

• ELECTRICAL CHARACTERISTICS by OUTPUT VOLTAGE

T_{opt} = 25°C

| Output Voltage V _{OUT} (V) | Dropout Voltage V _{DIF} (V) | | |
|--|--------------------------------------|------|------|
| | Condition | Typ. | Max. |
| 1.2 ≤ V _{OUT} < 1.3 | I _{OUT} = 150mA | 0.85 | 1.20 |
| 1.3 ≤ V _{OUT} < 1.4 | | 0.75 | 1.10 |
| 1.4 ≤ V _{OUT} < 1.5 | | 0.65 | 1.00 |
| 1.5 ≤ V _{OUT} < 1.7 | | 0.60 | 0.90 |
| 1.7 ≤ V _{OUT} < 1.9 | | 0.50 | 0.75 |
| 1.9 ≤ V _{OUT} < 2.1 | | 0.40 | 0.65 |
| 2.1 ≤ V _{OUT} < 2.8 | | 0.35 | 0.55 |
| 2.8 ≤ V _{OUT} ≤ 3.6 | | 0.25 | 0.40 |

TYPICAL CHARACTERISTICS

1) Output Voltage vs. Output Current (T_{opt}=25°C)



2) Output Voltage vs. Input Voltage (T_{opt}=25°C)



R1180x361x



3) Dropout Voltage vs. Output Current

R1180x121x



R1180x281x



R1180x361x



R1180x

4) Output Voltage vs. Temperature ($I_{OUT}=30mA$)

R1180x121x ($V_{IN}=2.2V$)



R1180x281x ($V_{IN}=3.8V$)



R1180x361x ($V_{IN}=4.6V$)



5) Supply Current vs. Input Voltage ($T_{opt}=25^{\circ}C$)

R1180x121x

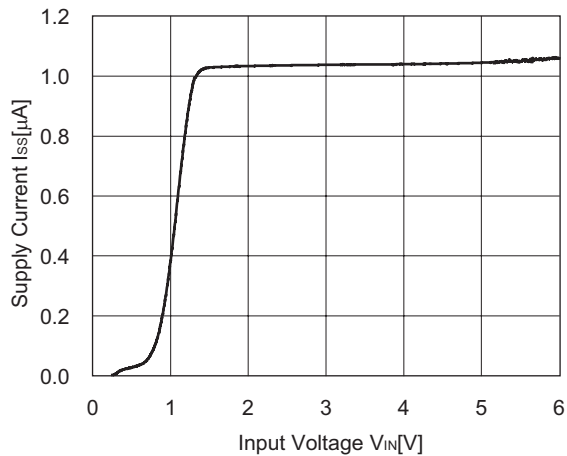

R1180x281x

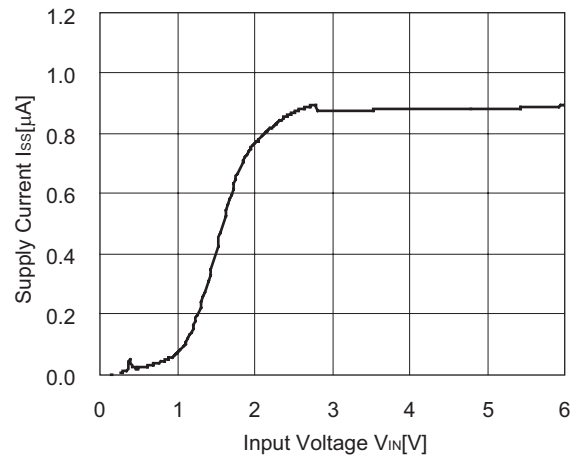

R1180x361x

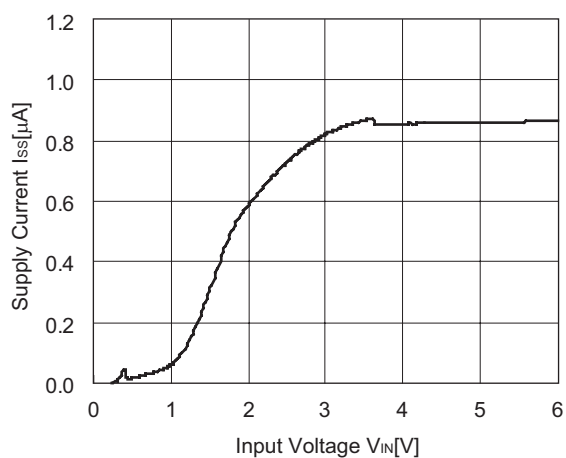

6) Supply Current vs. Temperature

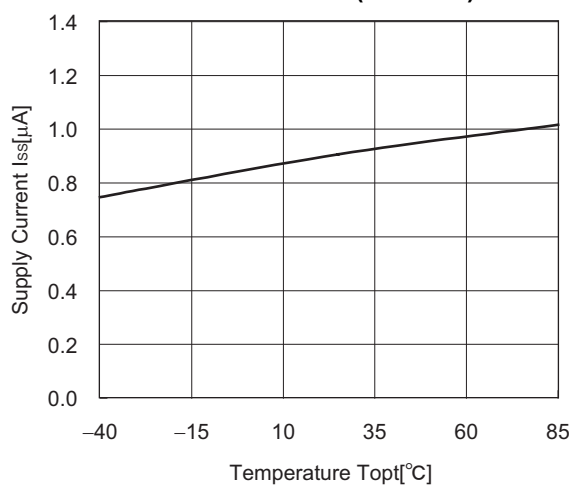
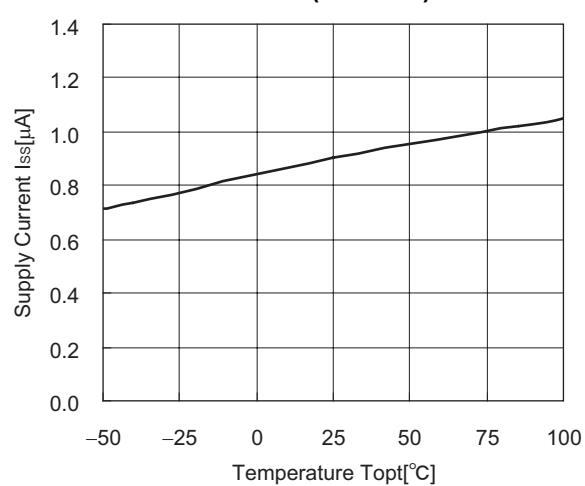
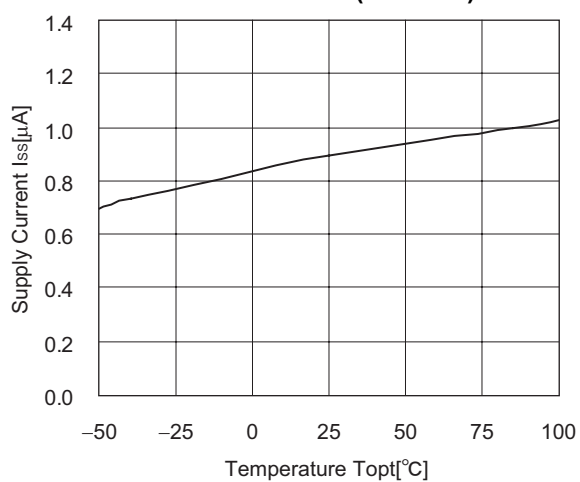
R1180x121x($V_{IN}=2.2V$)R1180x281x($V_{IN}=3.8V$)R1180x361x($V_{IN}=4.6V$)

R1180x

7) Dropout Voltage vs. Set Output Voltage ($T_{opt}=25^{\circ}\text{C}$)



8) Ripple Rejection vs. Frequency ($C_{IN}=\text{none}$)

R1180x121x

$V_{IN}=2.4V_{DC}+0.5p-p$
 $C_{OUT}=\text{Ceramic } 0.1\mu\text{F}$



R1180x121x

$V_{IN}=2.4V_{DC}+0.5p-p$
 $C_{OUT}=\text{Ceramic } 1\mu\text{F}$

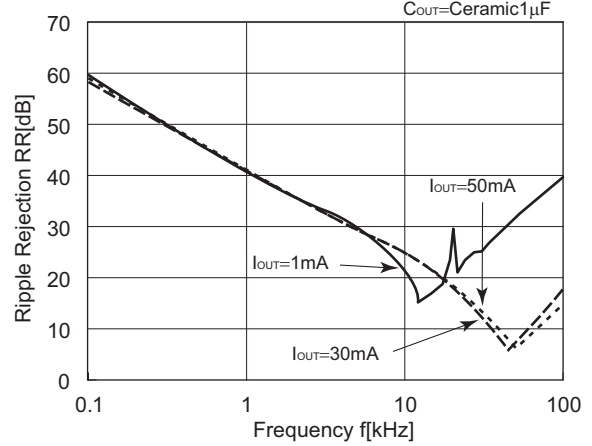

R1180x281x

$V_{IN}=3.8V_{DC}+0.5p-p$
 $C_{OUT}=\text{Ceramic } 0.1\mu\text{F}$



R1180x281x

$V_{IN}=3.8V_{DC}+0.5p-p$
 $C_{OUT}=\text{Ceramic } 1\mu\text{F}$

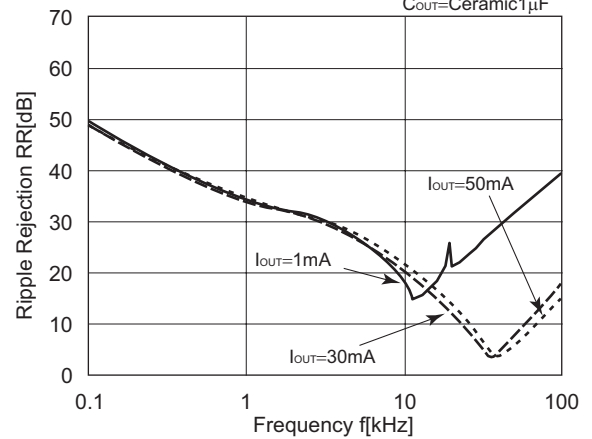



9) Ripple Rejection vs. Input Bias Voltage ($T_{opt}=25^{\circ}C$, $C_{IN}=\text{none}$, $C_{OUT}=\text{ceramic } 0.1\mu F$)

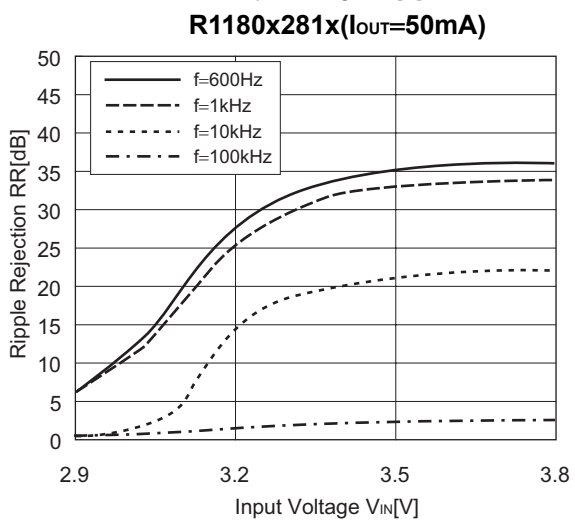
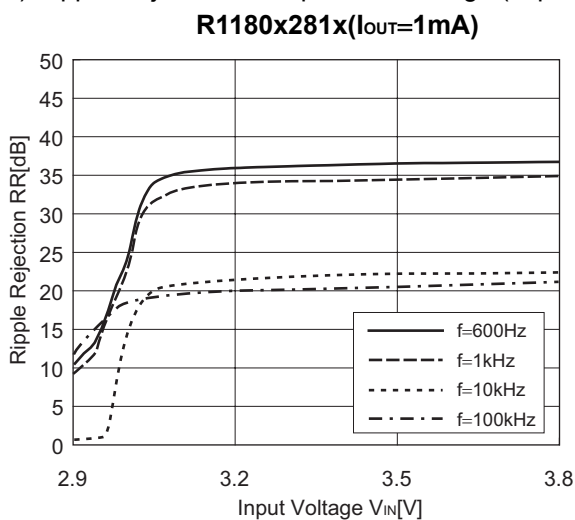

10) Input Transient Response ($C_{IN}=none, tr=tf=5\mu s$)

R1180x281x



R1180x281x



R1180x281x



R1180x281x



11) Load Transient Response ($t_r=t_f=0.5\mu s$ $V_{IN}=3.8V$)

R1180x281x



R1180x281x



R1180x281x

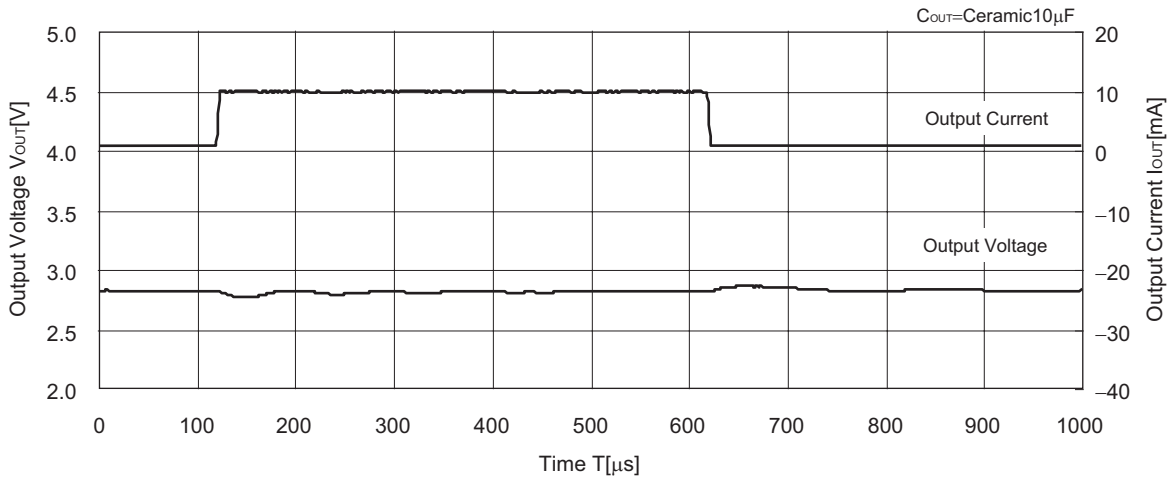

R1180x281x

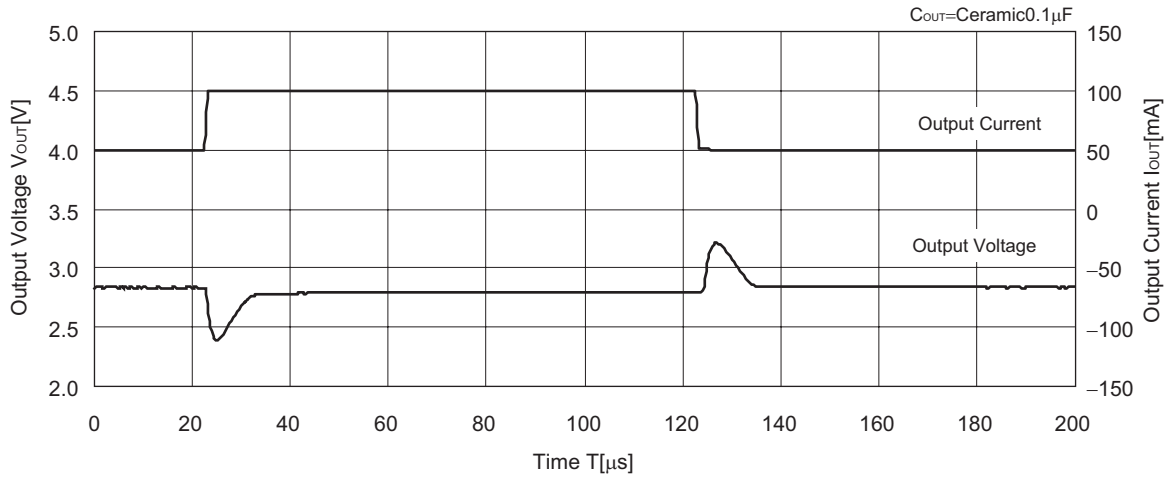

R1180x281x

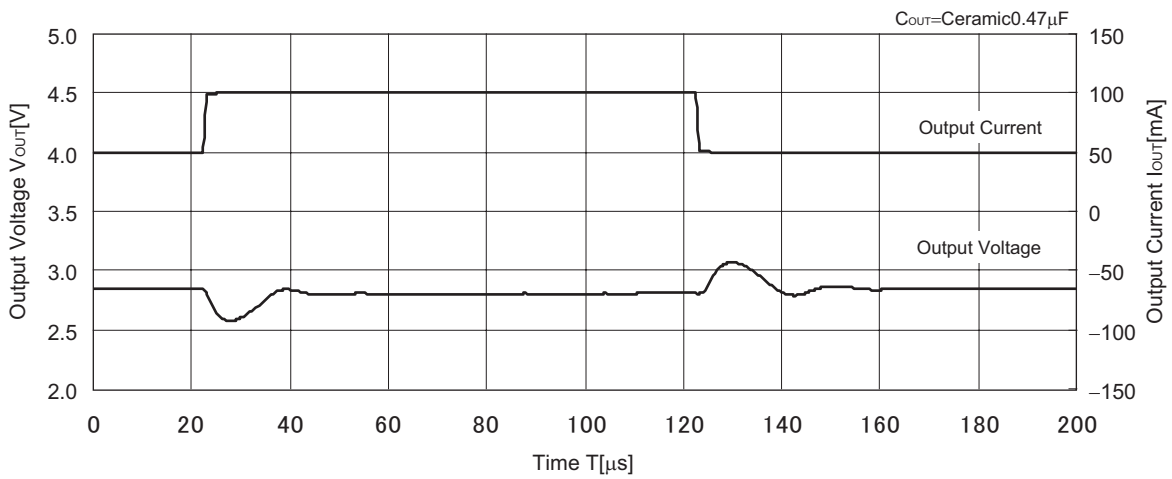



12) ESR vs. Output Current

R1180x121x($C_{IN} = \text{Ceramic } 1.0\mu\text{A}$, $C_{OUT} = \text{Ceramic } 0.1\mu\text{F}$)**R1180x281x**($C_{IN} = \text{Ceramic } 1.0\mu\text{A}$, $C_{OUT} = \text{Ceramic } 0.1\mu\text{F}$)

The relations between I_{OUT} (Output Current) and ESR of an output capacitor are shown above. The conditions when the white noise level is under $40\mu\text{V}$ (Avg.) are marked as the hatched area in the graph.

<Measurement conditions>

- (1) $V_{IN} = V_{OUT} + 1V$
- (2) Frequency Band: 10Hz to 2MHz (BW=30Hz)
- (3) Temperature: -40°C to 85°C

- SOT-23-5 (SC-74A)

Unit: mm

PACKAGE DIMENSIONS



TAPING SPECIFICATION



TAPING REEL DIMENSIONS

(1reel=3000pcs)



POWER DISSIPATION (SOT-23-5)

This specification is at mounted on board. Power Dissipation (P_D) depends on conditions of mounting on board. This specification is based on the measurement at the condition below:

(Power Dissipation (SOT-23-5) is substitution of SOT-23-6.)

Measurement Conditions

| | |
|------------------|--|
| | Standard Land Pattern |
| Environment | Mounting on Board (Wind velocity=0m/s) |
| Board Material | Glass cloth epoxy plactic (Double sided) |
| Board Dimensions | 40mm × 40mm × 1.6mm |
| Copper Ratio | Top side : Approx. 50% , Back side : Approx. 50% |
| Through-hole | φ0.5mm × 44pcs |

Measurement Result

($T_{opt}=25^{\circ}C, T_{jmax}=125^{\circ}C$)

| | | |
|--------------------|--|-------------------|
| | Standard Land Pattern | Free Air |
| Power Dissipation | 420mW | 250mW |
| Thermal Resistance | $\theta_{ja}=(125-25^{\circ}C)/0.42W=263^{\circ}C/W$ | 400 $^{\circ}C/W$ |



Power Dissipation



Measurement Board Pattern

○ IC Mount Area Unit : mm

RECOMMENDED LAND PATTERN



• SC-82AB

Unit: mm

PACKAGE DIMENSIONS



TAPING SPECIFICATION



TAPING REEL DIMENSIONS

(1reel=3000pcs)



POWER DISSIPATION (SC-82AB)

This specification is at mounted on board. Power Dissipation (P_D) depends on conditions of mounting on board. This specification is based on the measurement at the condition below:

Measurement Conditions

| | |
|------------------|--|
| | Standard Land Pattern |
| Environment | Mounting on Board (Wind velocity=0m/s) |
| Board Material | Glass cloth epoxy plactic (Double sided) |
| Board Dimensions | 40mm × 40mm × 1.6mm |
| Copper Ratio | Top side : Approx. 50% , Back side : Approx. 50% |
| Through-hole | φ0.5mm × 44pcs |

Measurement Result

($T_{opt}=25^{\circ}C, T_{jmax}=125^{\circ}C$)

| | | |
|--------------------|--|-------------------|
| | Standard Land Pattern | Free Air |
| Power Dissipation | 380mW | 150mW |
| Thermal Resistance | $\theta_{ja}=(125-25^{\circ}C)/0.38W=263^{\circ}C/W$ | 667 $^{\circ}C/W$ |



Power Dissipation

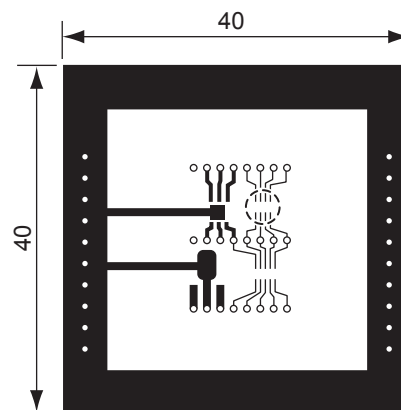

Measurement Board Pattern

○ IC Mount Area (Unit : mm)

RECOMMENDED LAND PATTERN



(Unit: mm)

• SON1612-6

Unit: mm

PACKAGE DIMENSIONS

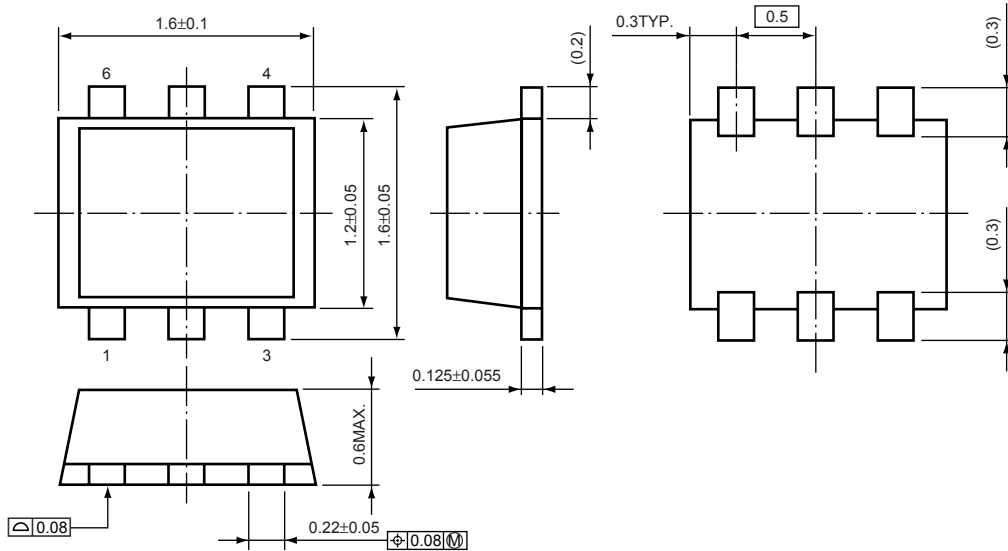

TAPING SPECIFICATION

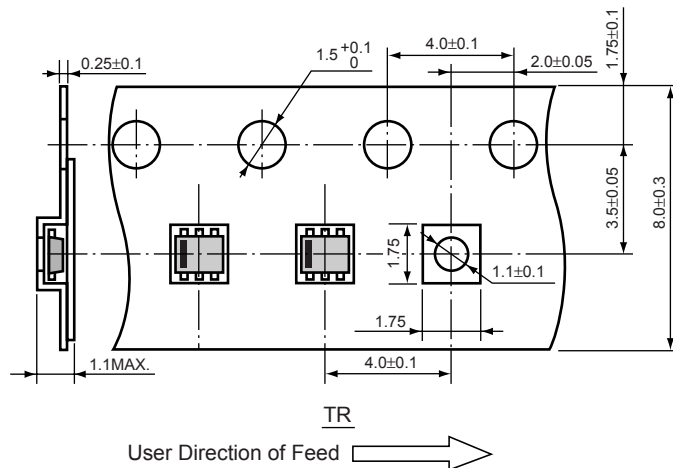

TAPING REEL DIMENSIONS

(1reel=4000pcs)

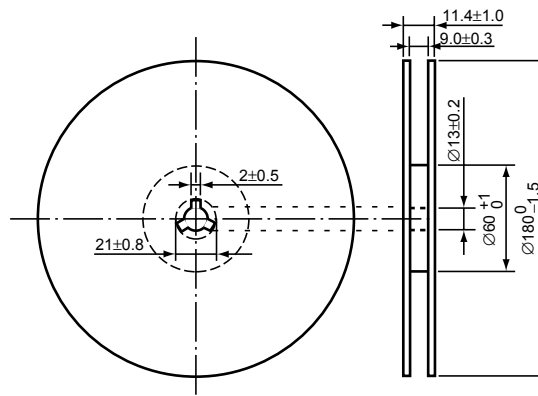

Power Dissipation (SON1612-6)

This specification is at mounted on board.

Power Dissipation (P_D) depends on conditions of mounting on board. This specification is based on the measurement at the condition below:

Measurement Conditions

| | |
|------------------|--|
| | Standard Land Pattern |
| Environment | Mounting on Board (Wind velocity=0m/s) |
| Board Material | Glass cloth epoxy plastic (Double sided) |
| Board Dimensions | 40mm × 40mm × 1.6mm |
| Copper Ratio | Top side : Approx. 50%, Back side : Approx.50% |
| Through-hole | φ0.5mm × 24pcs |

Measurement Result

($T_{opt}=25^{\circ}C, T_{jmax}=125^{\circ}C$)

| | |
|--------------------|---|
| | Standard Land Pattern |
| Power Dissipation | 500mW |
| Thermal Resistance | $\theta_{ja}=(125-25^{\circ}C)/0.5W=200^{\circ}C/W$ |



Power Dissipation

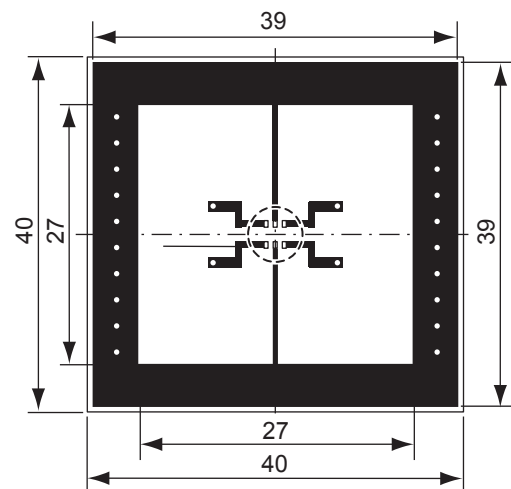

Measurement Board Pattern

○ IC Mount Area Unit : mm

RECOMMENDED LAND PATTERN



(Unit: mm)

R1180N SERIES MARK SPECIFICATION

• SOT-23-5 (SC-74A)



①, ②, ③ : Product Code (refer to Part Number vs. Product Code)

④, ⑤ : Lot Number

• Part Number vs. Product Code

| Part Number | Product Code | | |
|-------------|--------------|---|---|
| | ① | ② | ③ |
| R1180N121B | C | 1 | 2 |
| R1180N131B | C | 1 | 3 |
| R1180N141B | C | 1 | 4 |
| R1180N151B | C | 1 | 5 |
| R1180N161B | C | 1 | 6 |
| R1180N171B | C | 1 | 7 |
| R1180N181B | C | 1 | 8 |
| R1180N191B | C | 1 | 9 |
| R1180N201B | C | 2 | 0 |
| R1180N211B | C | 2 | 1 |
| R1180N221B | C | 2 | 2 |
| R1180N231B | C | 2 | 3 |
| R1180N241B | C | 2 | 4 |
| R1180N251B | C | 2 | 5 |
| R1180N261B | C | 2 | 6 |
| R1180N271B | C | 2 | 7 |
| R1180N281B | C | 2 | 8 |
| R1180N291B | C | 2 | 9 |
| R1180N301B | C | 3 | 0 |
| R1180N311B | C | 3 | 1 |
| R1180N321B | C | 3 | 2 |
| R1180N331B | C | 3 | 3 |
| R1180N341B | C | 3 | 4 |
| R1180N351B | C | 3 | 5 |
| R1180N361B | C | 3 | 6 |

| Part Number | Product Code | | |
|-------------|--------------|---|---|
| | ① | ② | ③ |
| R1180N121C | D | 1 | 2 |
| R1180N131C | D | 1 | 3 |
| R1180N141C | D | 1 | 4 |
| R1180N151C | D | 1 | 5 |
| R1180N161C | D | 1 | 6 |
| R1180N171C | D | 2 | 7 |
| R1180N181C | D | 2 | 8 |
| R1180N191C | D | 2 | 9 |
| R1180N201C | D | 2 | 0 |
| R1180N211C | D | 2 | 1 |
| R1180N221C | D | 2 | 2 |
| R1180N231C | D | 2 | 3 |
| R1180N241C | D | 2 | 4 |
| R1180N251C | D | 2 | 5 |
| R1180N261C | D | 2 | 6 |
| R1180N271C | D | 3 | 7 |
| R1180N281C | D | 3 | 8 |
| R1180N291C | D | 3 | 9 |
| R1180N301C | D | 3 | 0 |
| R1180N311C | D | 3 | 1 |
| R1180N321C | D | 3 | 2 |
| R1180N331C | D | 3 | 3 |
| R1180N341C | D | 3 | 4 |
| R1180N351C | D | 3 | 5 |
| R1180N361C | D | 3 | 6 |

R1180Q SERIES MARK SPECIFICATION

• SC-82AB



①, ② : Product Code (refer to Part Number vs. Product Code)

③, ④ : Lot Number

• Part Number vs. Product Code

| Part Number | Product Code | |
|-------------|--------------|---|
| | ① | ② |
| R1180Q121B | A | 2 |
| R1180Q131B | A | 3 |
| R1180Q141B | A | 4 |
| R1180Q151B | A | 5 |
| R1180Q161B | A | 6 |
| R1180Q171B | A | 7 |
| R1180Q181B | A | 8 |
| R1180Q191B | A | 9 |
| R1180Q201B | B | 0 |
| R1180Q211B | B | 1 |
| R1180Q221B | B | 2 |
| R1180Q231B | B | 3 |
| R1180Q241B | B | 4 |
| R1180Q251B | B | 5 |
| R1180Q261B | B | 6 |
| R1180Q271B | B | 7 |
| R1180Q281B | B | 8 |
| R1180Q291B | B | 9 |
| R1180Q301B | C | 0 |
| R1180Q311B | C | 1 |
| R1180Q321B | C | 2 |
| R1180Q331B | C | 3 |
| R1180Q341B | C | 4 |
| R1180Q351B | C | 5 |
| R1180Q361B | C | 6 |

| Part Number | Product Code | |
|-------------|--------------|---|
| | ① | ② |
| R1180Q121C | D | 2 |
| R1180Q131C | D | 3 |
| R1180Q141C | D | 4 |
| R1180Q151C | D | 5 |
| R1180Q161C | D | 6 |
| R1180Q171C | D | 7 |
| R1180Q181C | D | 8 |
| R1180Q191C | D | 9 |
| R1180Q201C | E | 0 |
| R1180Q211C | E | 1 |
| R1180Q221C | E | 2 |
| R1180Q231C | E | 3 |
| R1180Q241C | E | 4 |
| R1180Q251C | E | 5 |
| R1180Q261C | E | 6 |
| R1180Q271C | E | 7 |
| R1180Q281C | E | 8 |
| R1180Q291C | E | 9 |
| R1180Q301C | F | 0 |
| R1180Q311C | F | 1 |
| R1180Q321C | F | 2 |
| R1180Q331C | F | 3 |
| R1180Q341C | F | 4 |
| R1180Q351C | F | 5 |
| R1180Q361C | F | 6 |

R1180D SERIES MARK SPECIFICATION

● SON1612-6



①~④ : Product Code (refer to Part Number vs. Product Code)

⑤, ⑥ : Lot Number

● Part Number vs. Product Code

| Part Number | Product Code | | | |
|-------------|--------------|---|---|---|
| | ① | ② | ③ | ④ |
| R1180D121B | G | 1 | 2 | B |
| R1180D131B | G | 1 | 3 | B |
| R1180D141B | G | 1 | 4 | B |
| R1180D151B | G | 1 | 5 | B |
| R1180D161B | G | 1 | 6 | B |
| R1180D171B | G | 1 | 7 | B |
| R1180D181B | G | 1 | 8 | B |
| R1180D191B | G | 1 | 9 | B |
| R1180D201B | G | 2 | 0 | B |
| R1180D211B | G | 2 | 1 | B |
| R1180D221B | G | 2 | 2 | B |
| R1180D231B | G | 2 | 3 | B |
| R1180D241B | G | 2 | 4 | B |
| R1180D251B | G | 2 | 5 | B |
| R1180D261B | G | 2 | 6 | B |
| R1180D271B | G | 2 | 7 | B |
| R1180D281B | G | 2 | 8 | B |
| R1180D291B | G | 2 | 9 | B |
| R1180D301B | G | 3 | 0 | B |
| R1180D311B | G | 3 | 1 | B |
| R1180D321B | G | 3 | 2 | B |
| R1180D331B | G | 3 | 3 | B |
| R1180D341B | G | 3 | 4 | B |
| R1180D351B | G | 3 | 5 | B |
| R1180D361B | G | 3 | 6 | B |
| R1180D181B5 | G | 0 | 0 | B |

| Part Number | Product Code | | | |
|-------------|--------------|---|---|---|
| | ① | ② | ③ | ④ |
| R1180D121C | G | 1 | 2 | C |
| R1180D131C | G | 1 | 3 | C |
| R1180D141C | G | 1 | 4 | C |
| R1180D151C | G | 1 | 5 | C |
| R1180D161C | G | 1 | 6 | C |
| R1180D171C | G | 1 | 7 | C |
| R1180D181C | G | 1 | 8 | C |
| R1180D191C | G | 1 | 9 | C |
| R1180D201C | G | 2 | 0 | C |
| R1180D211C | G | 2 | 1 | C |
| R1180D221C | G | 2 | 2 | C |
| R1180D231C | G | 2 | 3 | C |
| R1180D241C | G | 2 | 4 | C |
| R1180D251C | G | 2 | 5 | C |
| R1180D261C | G | 2 | 6 | C |
| R1180D271C | G | 2 | 7 | C |
| R1180D281C | G | 2 | 8 | C |
| R1180D291C | G | 2 | 9 | C |
| R1180D301C | G | 3 | 0 | C |
| R1180D311C | G | 3 | 1 | C |
| R1180D321C | G | 3 | 2 | C |
| R1180D331C | G | 3 | 3 | C |
| R1180D341C | G | 3 | 4 | C |
| R1180D351C | G | 3 | 5 | C |
| R1180D361C | G | 3 | 6 | C |
| | | | | |

Компания «Океан Электроники» предлагает заключение долгосрочных отношений при поставках импортных электронных компонентов на взаимовыгодных условиях!

Наши преимущества:

- Поставка оригинальных импортных электронных компонентов напрямую с производств Америки, Европы и Азии, а так же с крупнейших складов мира;
- Широкая линейка поставок активных и пассивных импортных электронных компонентов (более 30 млн. наименований);
- Поставка сложных, дефицитных, либо снятых с производства позиций;
- Оперативные сроки поставки под заказ (от 5 рабочих дней);
- Экспресс доставка в любую точку России;
- Помощь Конструкторского Отдела и консультации квалифицированных инженеров;
- Техническая поддержка проекта, помощь в подборе аналогов, поставка прототипов;
- Поставка электронных компонентов под контролем ВП;
- Система менеджмента качества сертифицирована по Международному стандарту ISO 9001;
- При необходимости вся продукция военного и аэрокосмического назначения проходит испытания и сертификацию в лаборатории (по согласованию с заказчиком);
- Поставка специализированных компонентов военного и аэрокосмического уровня качества (Xilinx, Altera, Analog Devices, Intersil, Interpoint, Microsemi, Actel, Aeroflex, Peregrine, VPT, Syfer, Eurofarad, Texas Instruments, MS Kennedy, Miteq, Cobham, E2V, MA-COM, Hittite, Mini-Circuits, General Dynamics и др.);

Компания «Океан Электроники» является официальным дистрибьютором и эксклюзивным представителем в России одного из крупнейших производителей разъемов военного и аэрокосмического назначения «**JONHON**», а так же официальным дистрибьютором и эксклюзивным представителем в России производителя высокотехнологичных и надежных решений для передачи СВЧ сигналов «**FORSTAR**».



JONHON

«**JONHON**» (основан в 1970 г.)

Разъемы специального, военного и аэрокосмического назначения:

(Применяются в военной, авиационной, аэрокосмической, морской, железнодорожной, горно- и нефтедобывающей отраслях промышленности)

«**FORSTAR**» (основан в 1998 г.)

ВЧ соединители, коаксиальные кабели,
кабельные сборки и микроволновые компоненты:

(Применяются в телекоммуникациях гражданского и специального назначения, в средствах связи, РЛС, а так же военной, авиационной и аэрокосмической отраслях промышленности).



Телефон: 8 (812) 309-75-97 (многоканальный)

Факс: 8 (812) 320-03-32

Электронная почта: ocean@oceanchips.ru

Web: <http://oceanchips.ru/>

Адрес: 198099, г. Санкт-Петербург, ул. Калинина, д. 2, корп. 4, лит. А