



MIC803

3-Pin Microprocessor Supervisor Circuit with Open-Drain Reset Output

General Description

The MIC803 is a single-voltage supervisor with open-drain reset output that provides accurate power supply monitoring and reset generation in microprocessor based systems. The function of the device is to assert a reset signal if the power supply voltage drops below the Reset Threshold voltage, and retain this reset for the Reset Timeout Period once the power supply increases above the Reset Threshold voltage.

The MIC803 consumes only 4.5 μ A of supply current and offers three reset delay periods of 20ms, 140ms and 1120ms (min). It features factory programmed reset threshold levels from 2.63V to 4.63V to accommodate 3.0V, 3.3V, and 5.0V power supplies. It is available in the compact 3-pin SC-70 and SOT-23 packages.

Features

- 4.5 μ A supply current (typical) at 3.6V
- Open-Drain /RESET output
- /RESET remains valid with V_{CC} as low as 1V
- 20ms, 140ms, or 1120ms (min) reset timeout Options
- 2.63V to 4.63V Preset Voltage Threshold Options
- 2.5% Voltage Threshold Accuracy over temperature
- 3-pin SC70-3 package (2.0mm x 2.1mm)
- 3-pin SOT-23 package (2.3mm x 2.9mm)
- -40°C to +125°C Junction Temperature Range

Applications

- Critical microcomputer power monitoring
- Portable equipment
- Solid state drives
- Printers/computers
- Embedded controllers

Typical Application

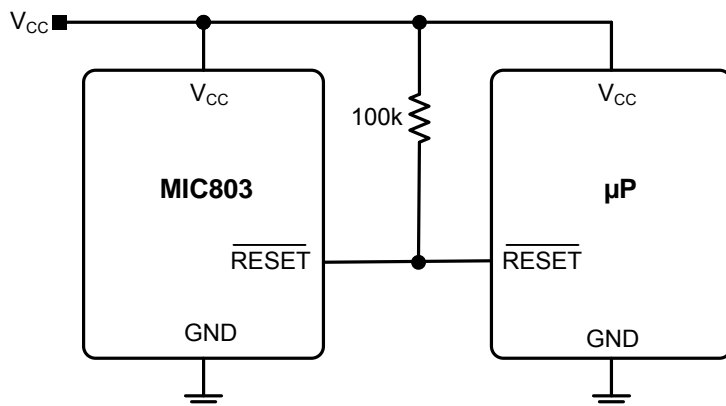

Supervisor Operation

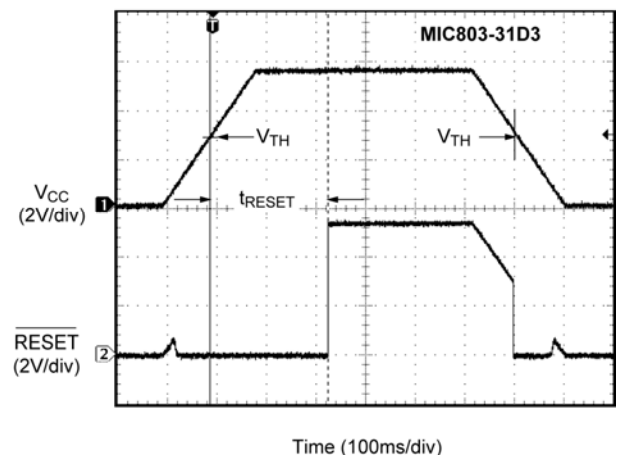

Ordering Information ⁽¹⁾

Part Number	Marking	Nominal V _{TH} (V)	Min. t _{RESET} ⁽²⁾ (ms)	Junction Temperature Range	Package
MIC803-46D2VC3	<u>AS</u>	4.63	20	-40° to +125°C	SC70-3
MIC803-44D2VC3	<u>AP</u>	4.38	20	-40° to +125°C	SC70-3
MIC803-41D2VC3	<u>AK</u>	4.10	20	-40° to +125°C	SC70-3
MIC803-40D2VC3	<u>A2</u>	4.00	20	-40° to +125°C	SC70-3
MIC803-31D2VC3	<u>AG</u>	3.08	20	-40° to +125°C	SC70-3
MIC803-30D2VC3	<u>AV</u>	3.00	20	-40° to +125°C	SC70-3
MIC803-29D2VC3	<u>AD</u>	2.93	20	-40° to +125°C	SC70-3
MIC803-26D2VC3	<u>AA</u>	2.63	20	-40° to +125°C	SC70-3
MIC803-46D3VC3	<u>AT</u>	4.63	140	-40° to +125°C	SC70-3
MIC803-44D3VC3	<u>AQ</u>	4.38	140	-40° to +125°C	SC70-3
MIC803-41D3VC3	<u>AM</u>	4.10	140	-40° to +125°C	SC70-3
MIC803-40D3VC3	<u>A5</u>	4.00	140	-40° to +125°C	SC70-3
MIC803-31D3VC3	<u>A4</u>	3.08	140	-40° to +125°C	SC70-3
MIC803-30D3VC3	<u>AX</u>	3.00	140	-40° to +125°C	SC70-3
MIC803-29D3VC3	<u>AE</u>	2.93	140	-40° to +125°C	SC70-3
MIC803-26D3VC3	<u>AB</u>	2.63	140	-40° to +125°C	SC70-3
MIC803-46D4VC3	<u>AU</u>	4.63	1120	-40° to +125°C	SC70-3
MIC803-44D4VC3	<u>AR</u>	4.38	1120	-40° to +125°C	SC70-3
MIC803-41D4VC3	<u>AN</u>	4.10	1120	-40° to +125°C	SC70-3
MIC803-40D4VC3	<u>A6</u>	4.00	1120	-40° to +125°C	SC70-3
MIC803-31D4VC3	<u>AJ</u>	3.08	1120	-40° to +125°C	SC70-3
MIC803-30D4VC3	<u>AZ</u>	3.00	1120	-40° to +125°C	SC70-3
MIC803-29D4VC3	<u>A3</u>	2.93	1120	-40° to +125°C	SC70-3
MIC803-26D4VC3	<u>AC</u>	2.63	1120	-40° to +125°C	SC70-3
MIC803-46D2VM3	<u>AS</u>	4.63	20	-40° to +125°C	SOT23-3
MIC803-44D2VM3	<u>AP</u>	4.38	20	-40° to +125°C	SOT23-3
MIC803-41D2VM3	<u>AK</u>	4.10	20	-40° to +125°C	SOT23-3
MIC803-40D2VM3	<u>A2</u>	4.00	20	-40° to +125°C	SOT23-3
MIC803-31D2VM3	<u>AG</u>	3.08	20	-40° to +125°C	SOT23-3
MIC803-30D2VM3	<u>AV</u>	3.00	20	-40° to +125°C	SOT23-3
MIC803-29D2VM3	<u>AD</u>	2.93	20	-40° to +125°C	SOT23-3
MIC803-26D2VM3	<u>AA</u>	2.63	20	-40° to +125°C	SOT23-3
MIC803-46D3VM3	<u>AT</u>	4.63	140	-40° to +125°C	SOT23-3
MIC803-44D3VM3	<u>AQ</u>	4.38	140	-40° to +125°C	SOT23-3
MIC803-41D3VM3	<u>AM</u>	4.10	140	-40° to +125°C	SOT23-3
MIC803-40D3VM3	<u>A5</u>	4.00	140	-40° to +125°C	SOT23-3
MIC803-31D3VM3	<u>A4</u>	3.08	140	-40° to +125°C	SOT23-3
MIC803-30D3VM3	<u>AX</u>	3.00	140	-40° to +125°C	SOT23-3
MIC803-29D3VM3	<u>AE</u>	2.93	140	-40° to +125°C	SOT23-3
MIC803-26D3VM3	<u>AB</u>	2.63	140	-40° to +125°C	SOT23-3

Part Number	Marking	Nominal V_{TH} (V)	Min. $t_{RESET}^{(2)}$ (ms)	Junction Temperature Range	Package
MIC803-46D4VM3	AU	4.63	1120	-40° to +125°C	SOT23-3
MIC803-44D4VM3	AR	4.38	1120	-40° to +125°C	SOT23-3
MIC803-41D4VM3	AN	4.10	1120	-40° to +125°C	SOT23-3
MIC803-40D4VM3	A6	4.00	1120	-40° to +125°C	SOT23-3
MIC803-31D4VM3	AJ	3.08	1120	-40° to +125°C	SOT23-3
MIC803-30D4VM3	AZ	3.00	1120	-40° to +125°C	SOT23-3
MIC803-29D4VM3	A3	2.93	1120	-40° to +125°C	SOT23-3
MIC803-26D4VM3	AC	2.63	1120	-40° to +125°C	SOT23-3

Notes:

- 1: All devices available in Tape and Reel only.
- 2: -40° to +85°C Temp. Range

Part Numbering Convention:

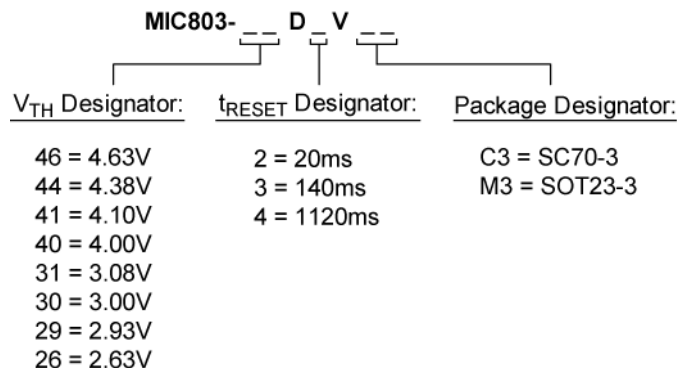

Pin Configuration

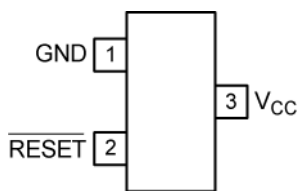

3-Pin SC70

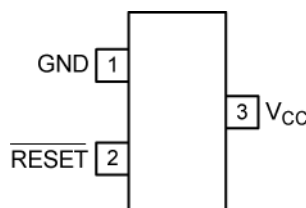

3-Pin SOT-23

Pin Description

Pin Number	Pin Name	Pin Function
1	GND	Ground Pin
2	/RESET	/RESET goes low if V_{CC} falls below the reset threshold (V_{TH}), and remains asserted for one timeout period after V_{CC} exceeds V_{TH}
3	V_{CC}	Power Supply Input and monitored voltage

Absolute Maximum Ratings⁽¹⁾

Supply Voltage (V_{CC})	-0.3V to 6.0V
Reset Output (/RESET)	-0.3V to 6.0V
Input Current (V_{CC})	20mA
Output Current (/RESET)	20mA
Rate of Rise (V_{CC})	100V/us
Junction Temperature (T_J)	+150°C
Lead Temperature (soldering, 10sec.)	260°C
Storage Temperature (T_S)	-65°C to +150°C
ESD Rating ⁽³⁾	3kV

Operating Ratings⁽²⁾

Supply Voltage (V_{CC})	1.0V to 5.5V
Reset Output Voltage (/RESET)	0.0V to 5.5V
Junction Temperature (T_J)	-40°C to +125°C
Junction Thermal Resistance	
3-Pin SC70 (θ_{JA})	260°C/W
3-Pin SOT23 (θ_{JA})	203°C/W

Electrical Characteristics⁽⁴⁾

For typical values, $V_{CC} = 5.0V$ for MIC803-46/44/41/40, $V_{CC} = 3.3V$ for MIC803-31/30/29, $V_{CC} = 3.0V$ for MIC803-26; $T_J = 25^\circ C$, **Bold** values indicate $-40^\circ C \leq T_J \leq +125^\circ C$; unless noted.

Parameter	Conditions	Min	Typ	Max	Units	
Power Supply Input						
Operating Voltage Range (V_{CC})	$T_J = -40^\circ C$ to $+85^\circ C$	1.0		5.5	V	
	$T_J = -40^\circ C$ to $+125^\circ C$	1.2		5.5		
Supply Current (I_{CC})	$T_J = -40^\circ C$ to $+85^\circ C$	$V_{CC} = 5.5V$, no Load		5.5	μA	
		$V_{CC} = 3.6V$, no Load		4.5		
	$T_J = +85^\circ C$ to $+125^\circ C$	$V_{CC} = 5.5V$, no Load				18
		$V_{CC} = 3.6V$, no Load				13
Voltage Threshold						
Reset Threshold (V_{TH})	MIC803-46	$T_J = -40^\circ C$ to $+85^\circ C$	4.50	4.63	4.75	V
		$T_J = -40^\circ C$ to $+125^\circ C$	4.44		4.82	
	MIC803-44	$T_J = -40^\circ C$ to $+85^\circ C$	4.25	4.38	4.50	
		$T_J = -40^\circ C$ to $+125^\circ C$	4.20		4.56	
	MIC803-41	$T_J = -40^\circ C$ to $+85^\circ C$	4.00	4.10	4.20	
		$T_J = -40^\circ C$ to $+125^\circ C$	3.97		4.24	
	MIC803-40	$T_J = -40^\circ C$ to $+85^\circ C$	3.89	4.00	4.10	
		$T_J = -40^\circ C$ to $+125^\circ C$	3.80		4.20	
	MIC803-31	$T_J = -40^\circ C$ to $+85^\circ C$	3.00	3.08	3.15	
		$T_J = -40^\circ C$ to $+125^\circ C$	2.95		3.21	
	MIC803-30	$T_J = -40^\circ C$ to $+85^\circ C$	2.93	3.00	3.08	
		$T_J = -40^\circ C$ to $+125^\circ C$	2.90		3.11	
	MIC803-29	$T_J = -40^\circ C$ to $+85^\circ C$	2.82	2.93	3.00	
		$T_J = -40^\circ C$ to $+125^\circ C$	2.81		3.05	
	MIC803-26	$T_J = -40^\circ C$ to $+85^\circ C$	2.55	2.63	2.70	
		$T_J = -40^\circ C$ to $+125^\circ C$	2.50		2.76	

Electrical Characteristics (Continued)

For typical values, $V_{CC} = 5.0V$ for MIC803-46/44/41/40, $V_{CC} = 3.3V$ for MIC803-31/30/29, $V_{CC} = 3.0V$ for MIC803-26; $T_J = 25^\circ C$, **Bold** values indicate $-40^\circ C \leq T_J \leq +125^\circ C$; unless noted.

Parameter	Conditions	Min	Typ	Max	Units	
Reset Time						
V_{CC} to /RESET Delay (t_D)	$V_{CC} = V_{TH}$ to $(V_{TH} - 100mV)$		15		μs	
Reset Timeout Period (t_{RESET})	D2	$T_J = -40^\circ C$ to $+85^\circ C$	20	35	44	ms
		$T_J = +85^\circ C$ to $+125^\circ C$	16		48	
	D3	$T_J = -40^\circ C$ to $+85^\circ C$	140	230	360	
		$T_J = +85^\circ C$ to $+125^\circ C$	112		420	
	D4	$T_J = -40^\circ C$ to $+85^\circ C$	1120	1800	2400	
		$T_J = +85^\circ C$ to $+125^\circ C$	900		3200	
Reset Output						
/RESET Output Voltage (V_{OL})	$V_{CC} \geq 4.0V$, $I_{SINK} = 3.2mA$			0.4	V	
	$V_{CC} > 2.5V$, $I_{SINK} = 1.2mA$			0.3	V	
	$V_{CC} \geq 1.0V$, $I_{SINK} = 50\mu A$			0.3	V	
/RESET Output Leakage	$V_{CC} > V_{TH}$, /RESET deasserted			1	μA	

Notes:

1. Exceeding the absolute maximum rating may damage the device.
2. The device is not guaranteed to function outside its operating rating.
3. Devices are ESD sensitive. Handling precautions recommended. Human body model, 1.5k Ω in series with 100pF.
4. Specification for packaged product only.

Typical Characteristics

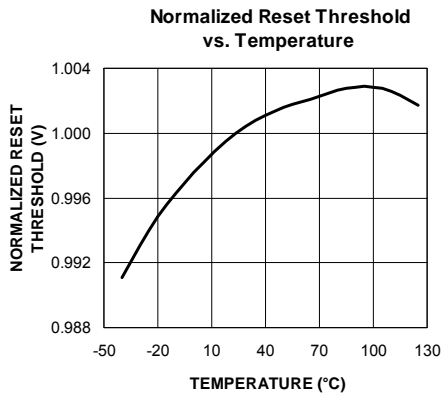
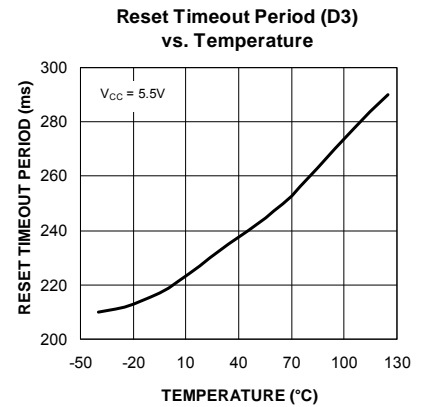
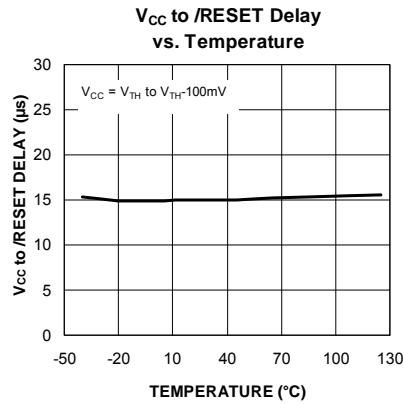

Timing Diagram

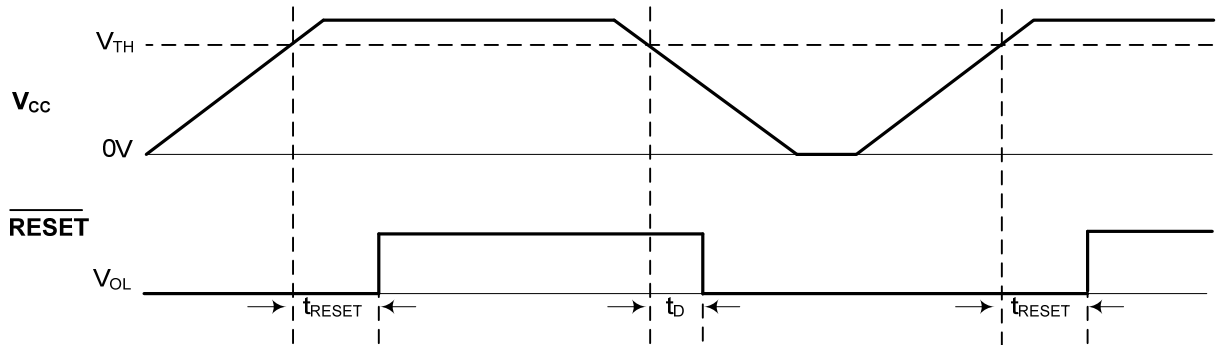

Functional Diagram



Application Information

Microprocessor Reset

The $\overline{\text{RESET}}$ pin is asserted whenever V_{CC} falls below the Reset Threshold Voltage, V_{TH} . The $\overline{\text{RESET}}$ pin remains asserted for the duration of the Reset Timeout Period (t_{RESET}) after V_{CC} has risen above the Reset Threshold Voltage. The reset function ensures the microprocessor is properly reset and powers up in a known condition after a power failure. $\overline{\text{RESET}}$ will remain valid with V_{CC} as low as 1.0V.

The $\overline{\text{RESET}}$ output is a simple open-drain N-channel MOSFET structure. A pull-up resistor must be used to pull this output up to some voltage. For most applications, this voltage will be the same power supply that supplies V_{CC} to the MIC803. As shown in Figure 1, it is possible, however, to tie this resistor to some other voltage. This will allow the MIC803 to monitor one voltage while level-shifting the $\overline{\text{RESET}}$ output to some other voltage. The pull-up voltage must be limited to 5.5V. The resistor must be small enough to supply current to the inputs and leakage paths that are driven by the $\overline{\text{RESET}}$ output.



Figure 1. MIC803 used in a Multiple Supply System

$\overline{\text{RESET}}$ Valid at Low Voltage

As V_{CC} drops to 0V, the MIC803 will no longer be able to pull the $\overline{\text{RESET}}$ output low, and the pull-up resistor will pull the output high. The value of the pull-up resistor and the voltage it is connected to will affect the point at which this happens.

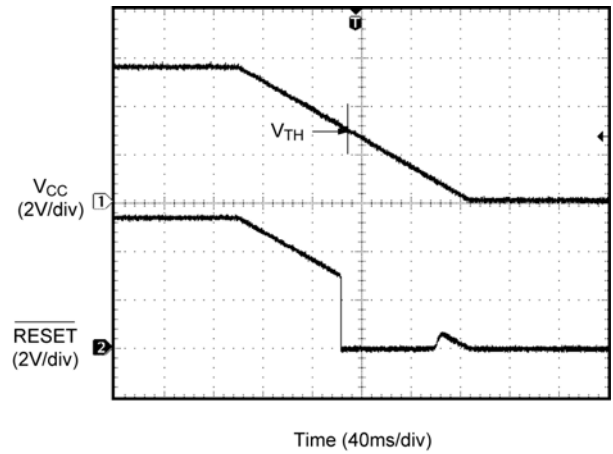

Figure 2. $\overline{\text{RESET}}$ at falling V_{CC}

Wire OR'ing The $\overline{\text{RESET}}$ Output

Since the $\overline{\text{RESET}}$ output is open-drain, several reset sources can be wire-ORed, in parallel, to allow resets from multiple sources.

V_{CC} Transients

The MIC803 is relatively immune to negative-going V_{CC} glitches below the Reset Threshold. See the Typical Characteristic Curve, *Maximum Transient Duration vs Overdrive* on page 6 of the datasheet. As shown in Figure 3, the Overdrive Voltage is the difference between the Threshold Voltage and the minimum point of the V_{CC} glitch. Typically, an overdrive of 100mV, with duration of 15 μs or less will not cause a reset. If additional transient immunity is needed, a 0.1 μF bypass capacitor can be placed as close as possible to the MIC803 on the V_{CC} pin.

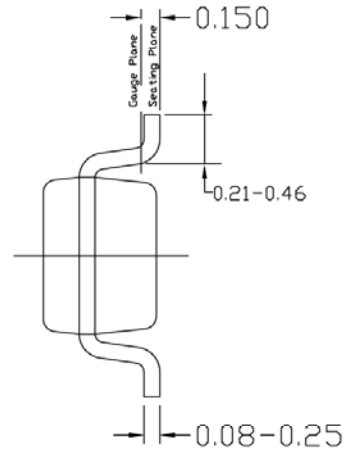

Figure 3. V_{CC} Transient

Package Information



TOP VIEW



END VIEW

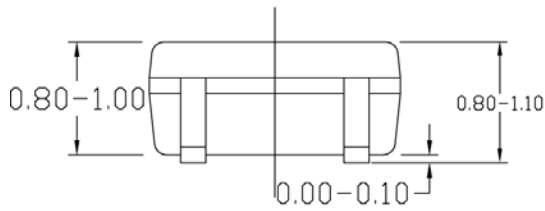

SIDE VIEW

NOTE:

1. ALL DIMENSIONS ARE IN MILLIMETERS.
2. DIMENSIONS ARE INCLUSIVE OF PLATING.
3. DIMENSIONS ARE EXCLUSIVE OF MOLD FLASH & METAL BURR.

3-Pin SC-70 (C3)



Top View



Side View



End View

NOTE:

1. All dimensions are in millimeters.
 2. Package surface to be matte finish VDI 11~13. Y14.5M, 1982.
 3. Die is facing up for mold & trim/form.
- ▲ Dimension are exclusive mold flash and gate burr.
 △ Dimension are exclusive solder plating.

3-Pin SOT-23 (M3)

MICREL, INC. 2180 FORTUNE DRIVE SAN JOSE, CA 95131 USA
 TEL +1 (408) 944-0800 FAX +1 (408) 474-1000 WEB <http://www.micrel.com>

Micrel makes no representations or warranties with respect to the accuracy or completeness of the information furnished in this data sheet. This information is not intended as a warranty and Micrel does not assume responsibility for its use. Micrel reserves the right to change circuitry, specifications and descriptions at any time without notice. No license, whether express, implied, arising by estoppel or otherwise, to any intellectual property rights is granted by this document. Except as provided in Micrel's terms and conditions of sale for such products, Micrel assumes no liability whatsoever, and Micrel disclaims any express or implied warranty relating to the sale and/or use of Micrel products including liability or warranties relating to fitness for a particular purpose, merchantability, or infringement of any patent, copyright or other intellectual property right.

Micrel Products are not designed or authorized for use as components in life support appliances, devices or systems where malfunction of a product can reasonably be expected to result in personal injury. Life support devices or systems are devices or systems that (a) are intended for surgical implant into the body or (b) support or sustain life, and whose failure to perform can be reasonably expected to result in a significant injury to the user. A Purchaser's use or sale of Micrel Products for use in life support appliances, devices or systems is a Purchaser's own risk and Purchaser agrees to fully indemnify Micrel for any damages resulting from such use or sale.

© 2010 Micrel, Incorporated.

Компания «Океан Электроники» предлагает заключение долгосрочных отношений при поставках импортных электронных компонентов на взаимовыгодных условиях!

Наши преимущества:

- Поставка оригинальных импортных электронных компонентов напрямую с производств Америки, Европы и Азии, а так же с крупнейших складов мира;
- Широкая линейка поставок активных и пассивных импортных электронных компонентов (более 30 млн. наименований);
- Поставка сложных, дефицитных, либо снятых с производства позиций;
- Оперативные сроки поставки под заказ (от 5 рабочих дней);
- Экспресс доставка в любую точку России;
- Помощь Конструкторского Отдела и консультации квалифицированных инженеров;
- Техническая поддержка проекта, помощь в подборе аналогов, поставка прототипов;
- Поставка электронных компонентов под контролем ВП;
- Система менеджмента качества сертифицирована по Международному стандарту ISO 9001;
- При необходимости вся продукция военного и аэрокосмического назначения проходит испытания и сертификацию в лаборатории (по согласованию с заказчиком);
- Поставка специализированных компонентов военного и аэрокосмического уровня качества (Xilinx, Altera, Analog Devices, Intersil, Interpoint, Microsemi, Actel, Aeroflex, Peregrine, VPT, Syfer, Eurofarad, Texas Instruments, MS Kennedy, Miteq, Cobham, E2V, MA-COM, Hittite, Mini-Circuits, General Dynamics и др.);

Компания «Океан Электроники» является официальным дистрибьютором и эксклюзивным представителем в России одного из крупнейших производителей разъемов военного и аэрокосмического назначения «JONHON», а так же официальным дистрибьютором и эксклюзивным представителем в России производителя высокотехнологичных и надежных решений для передачи СВЧ сигналов «FORSTAR».



JONHON

«JONHON» (основан в 1970 г.)

Разъемы специального, военного и аэрокосмического назначения:

(Применяются в военной, авиационной, аэрокосмической, морской, железнодорожной, горно- и нефтедобывающей отраслях промышленности)

«FORSTAR» (основан в 1998 г.)

ВЧ соединители, коаксиальные кабели, кабельные сборки и микроволновые компоненты:

(Применяются в телекоммуникациях гражданского и специального назначения, в средствах связи, РЛС, а так же военной, авиационной и аэрокосмической отраслях промышленности).



Телефон: 8 (812) 309-75-97 (многоканальный)

Факс: 8 (812) 320-03-32

Электронная почта: ocean@oceanchips.ru

Web: <http://oceanchips.ru/>

Адрес: 198099, г. Санкт-Петербург, ул. Калинина, д. 2, корп. 4, лит. А