

## HSME-C230

### Yellow Green Color Side-Mount ChipLED

---

#### Description

The Broadcom<sup>®</sup> HSME-C230 is a side-emitting surface-mount chipLED. This chipLED comes in small package footprint of 1.0 mm × 0.55 mm. Its small form factor allows flexible board design, and the LED can be closely mounted, thus offering maximum miniaturization benefits to the user.

The low package height of 0.3 mm makes it an ideal solution for an application that has limited head room, such as wearables and small portable handheld devices.

By using efficient and high brightness AlInGaP LED materials, this product is capable of delivering high light output. It is compatible with industry-standard automatic machine placement and reflow soldering.

#### Features

- LEDs with AlInGaP die
- Surface-mount device with 0.30-mm height
- Compatible with reflow soldering
- Tape in 8-mm carrier tape on a 7-in. diameter reel

#### Applications

- Backlighting
- Indicator

**CAUTION!** LEDs are class 1A ESD sensitive per ANSI/ESDA/JEDEC JS-001. Please observe appropriate precautions during handling and processing. Refer to Application Note AN-1142 for additional details.

**Figure 1: Package Dimensions**

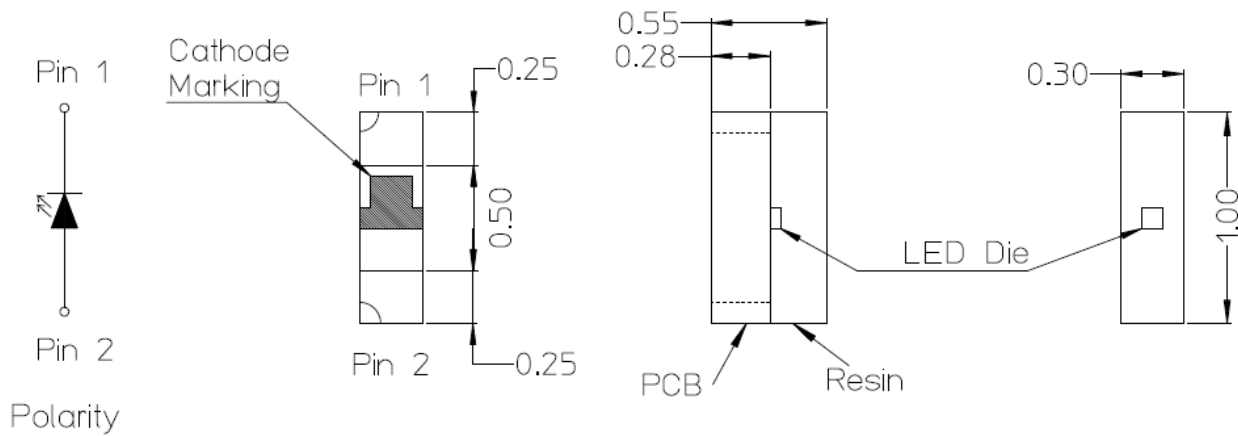

**NOTE:**

1. All dimensions are in millimeters.
2. Tolerance  $\pm 0.1$  mm unless otherwise specified.
3. Encapsulant: clear epoxy

**Absolute Maximum Value at  $T_j = 25^\circ\text{C}$**

Parameter	Rating	Units
DC Forward Current <sup>a</sup>	25	mA
Peak Forward Current <sup>b</sup>	80	mA
Power Dissipation	60	mW
LED Junction Temperature	95	$^\circ\text{C}$
Operating Temperature	-40 to +85	$^\circ\text{C}$
Storage Temperature	-40 to +85	$^\circ\text{C}$

a. Derate as shown in [Figure 10](#).

b. Duty factor = 10%, frequency = 1 kHz.

## Optical/Electrical Characteristics at $T_J = 25^\circ\text{C}$ , $I_F = 20\text{ mA}$

Parameter	Min.	Typ.	Max.	Units
Luminous Intensity, $I_v^a$	28.5	—	—	mcd
Dominant Wavelength, $\lambda_d^b$	—	572	—	nm
Peak Wavelength, $\lambda_p$	—	574	—	nm
Viewing Angle, $2\theta_{1/2}^c$	—	140	—	degree
Forward Voltage, $V_F$	1.6	—	2.4	V
Reverse Current, $I_R$ (at $V_R = 5\text{V}$ ) <sup>d</sup>	—	—	100	$\mu\text{A}$
Thermal Resistance, $R\theta_{J-S}$	—	300	—	$^\circ\text{C/W}$

- The luminous intensity is measured at the mechanical axis of the LED package. The actual peak of the spatial radiation pattern may not be aligned with the axis.
- The dominant wavelength is derived from the CIE chromaticity diagram and represents the perceived color of the device.
- Viewing angle is the off-axis angle where the luminous intensity is  $\frac{1}{2}$  the peak intensity.
- Indicates the product final test condition. Long-term reverse bias is not recommended.

## Bin Information

### Intensity Bins (CAT)

Bin ID	Luminous Intensity (mcd)	
	Min.	Max.
N	28.5	45.0
P	45.0	71.5
Q	71.5	112.5
R	112.5	180.0
S	180.0	285.0
T	285.0	450.0
U	450.0	715.0
V	715.0	1125.0
W	1125.0	1800.0
X	1800.0	2850.0
Y	2850.0	4500.0

Tolerance  $\pm 15\%$ .

Example of bin information on reel and packaging label:

CAT: N  $\rightarrow$  Yellow Green =  $I_v$  bin N

BIN: B  $\rightarrow$  Yellow Green = color bin B

### Color Bins (BIN)

Bin ID	Dominant Wavelength (nm)	
	Min.	Max.
B	564.5	567.5
C	567.5	570.5
D	570.5	573.5
E	573.5	576.5

Tolerance  $\pm 1\text{ nm}$ .

Figure 2: Intensity vs. Wavelength

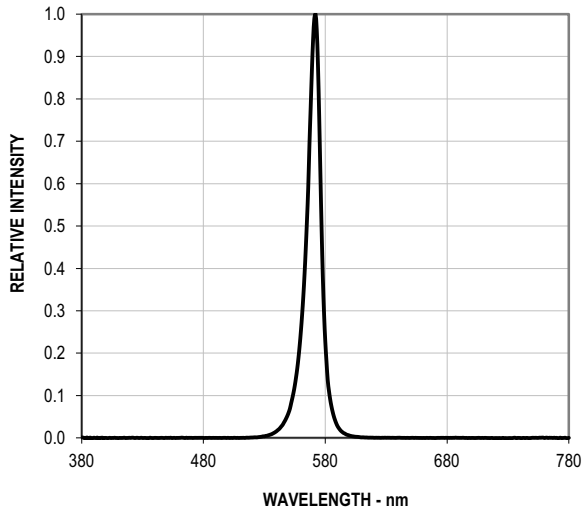

Figure 3: Forward Current vs. Forward Voltage

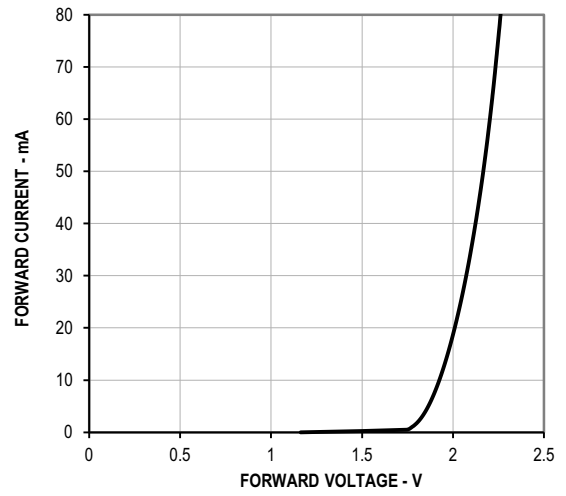

Figure 4: Intensity vs. Forward Current

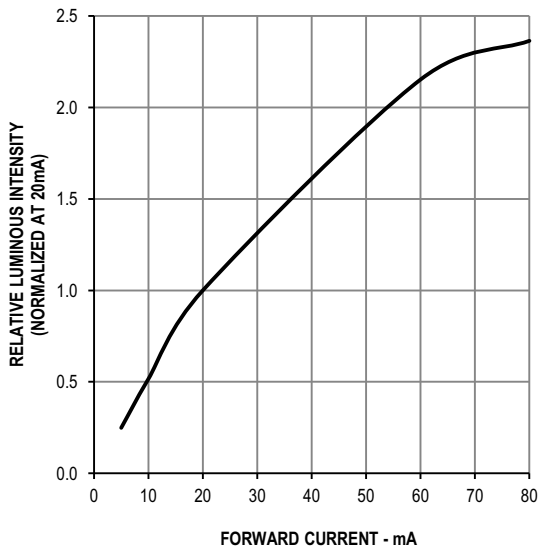

Figure 5: Intensity vs. Angle

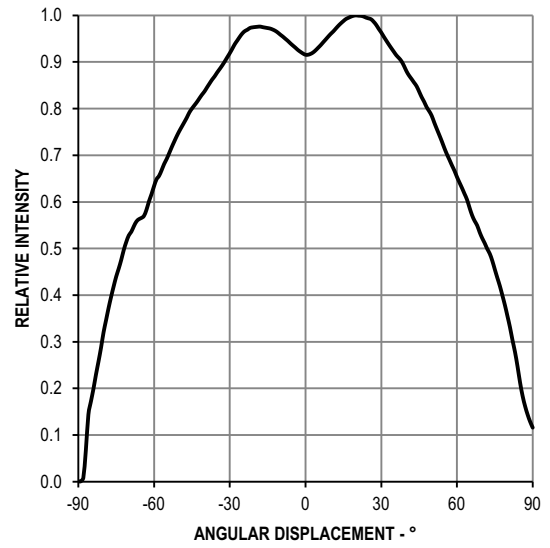

Figure 6: Wavelength vs. Forward Current

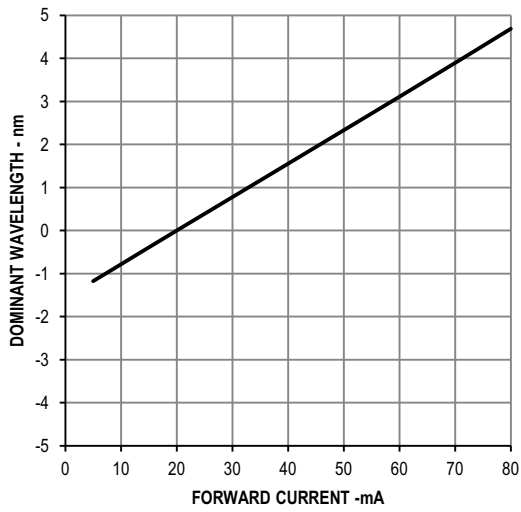

Figure 7: Intensity vs. Temperature

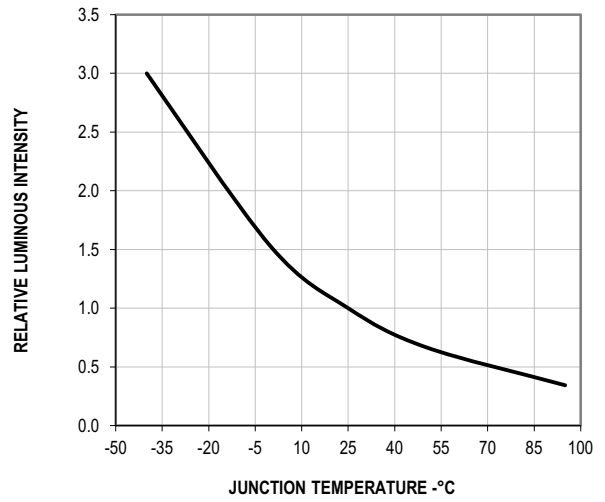

Figure 8: Wavelength vs. Temperature

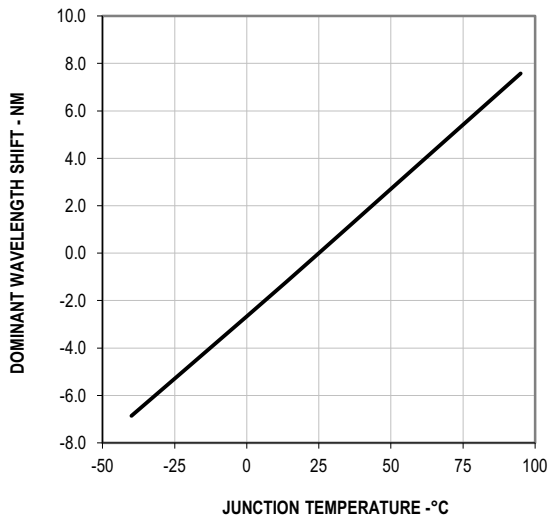
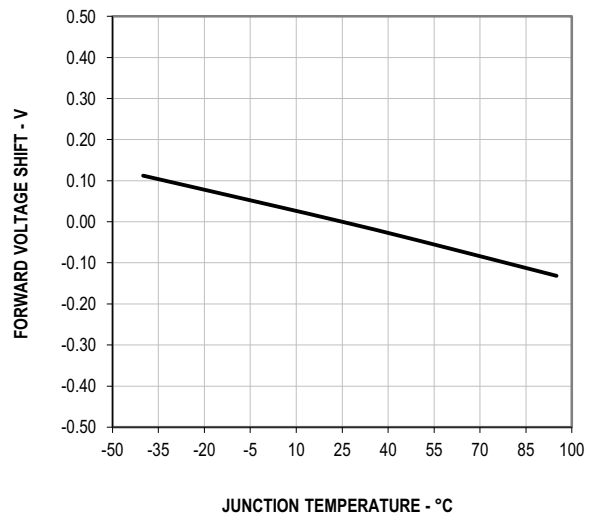
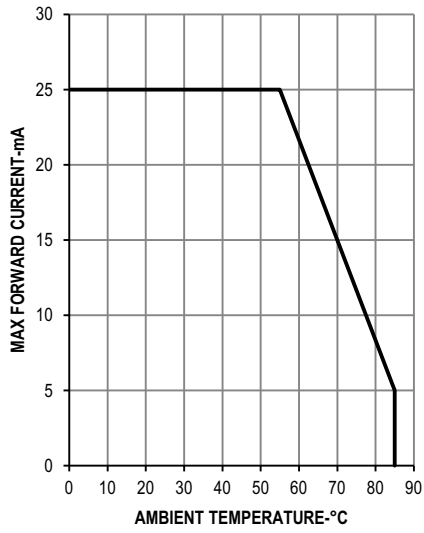

Figure 9: Forward Voltage vs. Temperature



**Figure 10: Forward Current vs. Temperature**



**Figure 11: Recommended Solder Pad (Units: mm)**

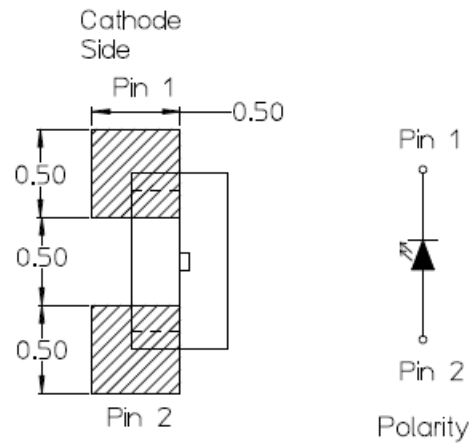
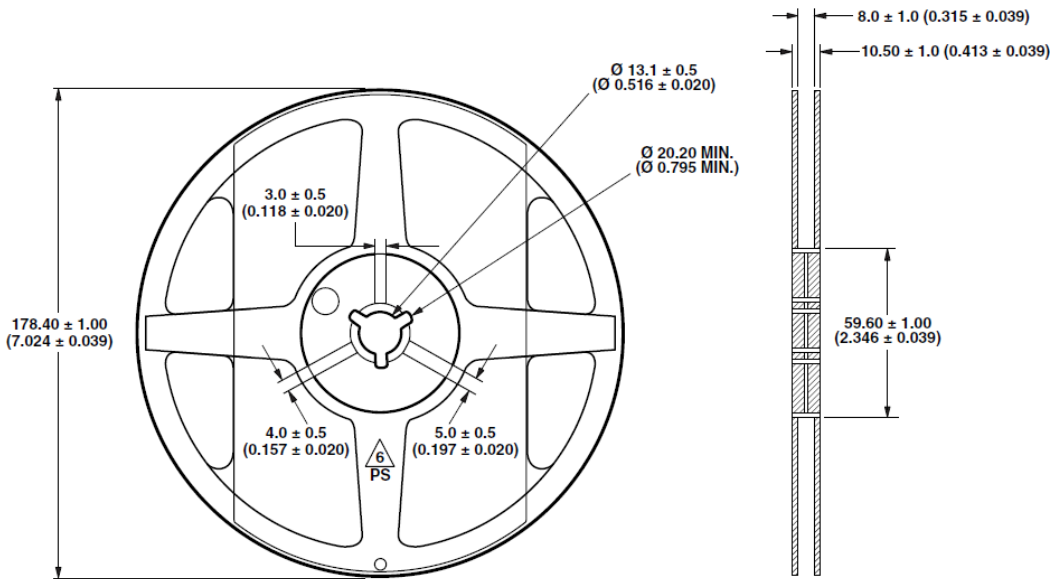
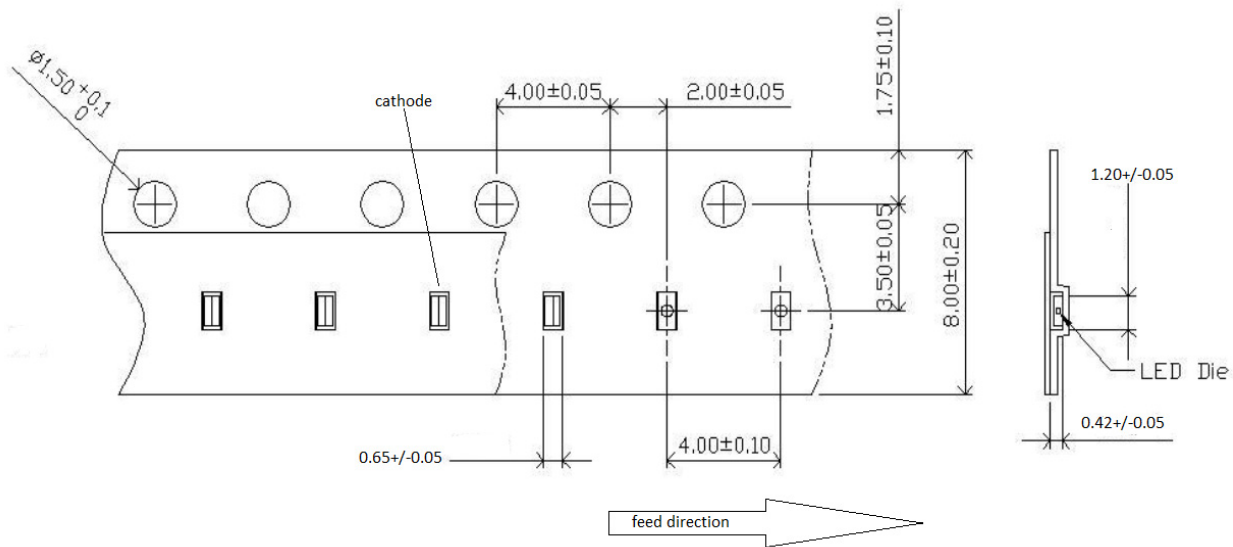

Figure 12: Reel Dimensions



NOTE:  
1. ALL DIMENSIONS IN MILLIMETERS (INCHES).

Figure 13: Carrier Tape Dimensions (Units: mm)



## Soldering

Figure 14: Recommended Reflow Soldering Conditions

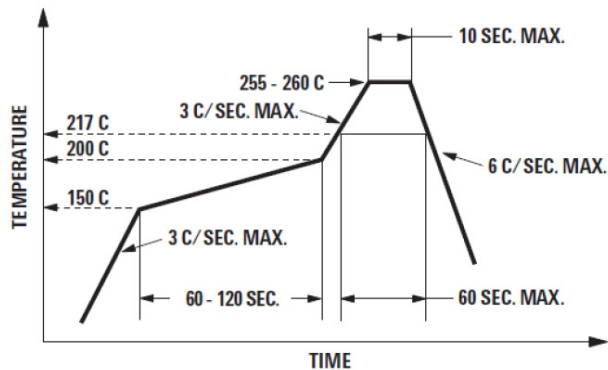

- Reflow soldering must not be done more than twice. Observe necessary precautions of handling moisture sensitive device as stated in the following section.
- Do not apply any pressure or force on the LED during reflow and after reflow when the LED is still hot.
- Use reflow soldering to solder the LED. If unavoidable (such as rework), use manual hand soldering strictly controlled to the following conditions:
  - Soldering iron tip temperature = 310°C maximum
  - Soldering duration = 2 seconds maximum
  - Number of cycles = 1 only
  - Power of soldering iron = 50W maximum
- Do not touch the LED package body with the soldering iron except for the soldering terminals because it might cause damage to the LED.
- Confirm beforehand whether the functionality and performance of the LED is affected by hand soldering.

## Precautionary Notes

### Handling of a Moisture-Sensitive Device

This product has a Moisture Sensitive Level 2a rating per JEDEC J-STD-020. Refer to Broadcom Application Note AN5305, *Handling of Moisture Sensitive Surface Mount Devices*, for additional details and a review of proper handling procedures.

#### ■ Before use

- An unopened moisture barrier bag (MBB) can be stored at < 40°C/90% RH for 12 months. If the actual shelf life has exceeded 12 months and the humidity indicator card (HIC) indicates that baking is not required, it is safe to reflow the LEDs per the original MSL rating.
- Do not open the MBB prior to assembly (for example, for IQC).

#### ■ Control after opening the MBB

- Read the HIC immediately upon opening the MBB.
- Keep the LEDs at < 30°C/60% RH at all times, and all high-temperature-related processes, including soldering, curing, or rework, must be completed within 672 hours.

#### ■ Control for unfinished reel

Store unused LEDs in a sealed MBB with desiccant or desiccator at < 5% RH.

#### ■ Control of assembled boards

If the PCB soldered with the LEDs is to be subjected to other high-temperature processes, store the PCB in a sealed MBB with desiccant or desiccator at < 5% RH to ensure that all LEDs have not exceeded their floor life of 672 hours.

#### ■ Baking is required if the following conditions exist:

- The HIC indicator indicates a change in color for 10% and 5% as stated on the HIC.
- The LEDs are exposed to conditions of > 30°C/60% RH at any time.
- The LEDs' floor life exceeded 672 hours.

The recommended baking condition is: 60°C ±5°C for 20 hours.

Baking should only be done once.



## Application Precautions

- The drive current of the LED must not exceed the maximum allowable limit across temperature as stated in the data sheet. Constant current driving is recommended to ensure consistent performance.
- LEDs exhibit slightly different characteristics at different drive currents that might result in larger performance variations (that is, intensity, wavelength, and forward voltage). Set the application current as close as possible to the test current to minimize these variations.
- The LED is not intended for reverse bias. Use other appropriate components for such purposes. When driving the LED in matrix form, ensure that the reverse bias voltage does not exceed the allowable limit of the LED.
- Avoid rapid change in ambient temperature, especially in high humidity environments, because this will cause condensation on the LED.
- If the LED is intended to be used in harsh environments, protect the LED against damages caused by rain water, dust, oil, corrosive gases, external mechanical stress, and so on.

## Disclaimer

Broadcom's products are not specifically designed, manufactured, or authorized for sale as parts, components, or assemblies for the planning, construction, maintenance, or direct operation of a nuclear facility or for use in medical devices or applications. The customer is solely responsible, and waives all rights to make claims against Broadcom or its suppliers, for all loss, damage, expense, or liability in connection with such use.

Broadcom, the pulse logo, Connecting everything, Avago Technologies, Avago, and the A logo are among the trademarks of Broadcom and/or its affiliates in the United States, certain other countries and/or the EU.

Copyright © 2017 by Broadcom. All Rights Reserved.

The term "Broadcom" refers to Broadcom Limited and/or its subsidiaries. For more information, please visit [www.broadcom.com](http://www.broadcom.com).

Broadcom reserves the right to make changes without further notice to any products or data herein to improve reliability, function, or design. Information furnished by Broadcom is believed to be accurate and reliable. However, Broadcom does not assume any liability arising out of the application or use of this information, nor the application or use of any product or circuit described herein, neither does it convey any license under its patent rights nor the rights of others.



Компания «Океан Электроники» предлагает заключение долгосрочных отношений при поставках импортных электронных компонентов на взаимовыгодных условиях!

Наши преимущества:

- Поставка оригинальных импортных электронных компонентов напрямую с производств Америки, Европы и Азии, а так же с крупнейших складов мира;
- Широкая линейка поставок активных и пассивных импортных электронных компонентов (более 30 млн. наименований);
- Поставка сложных, дефицитных, либо снятых с производства позиций;
- Оперативные сроки поставки под заказ (от 5 рабочих дней);
- Экспресс доставка в любую точку России;
- Помощь Конструкторского Отдела и консультации квалифицированных инженеров;
- Техническая поддержка проекта, помощь в подборе аналогов, поставка прототипов;
- Поставка электронных компонентов под контролем ВП;
- Система менеджмента качества сертифицирована по Международному стандарту ISO 9001;
- При необходимости вся продукция военного и аэрокосмического назначения проходит испытания и сертификацию в лаборатории (по согласованию с заказчиком);
- Поставка специализированных компонентов военного и аэрокосмического уровня качества (Xilinx, Altera, Analog Devices, Intersil, Interpoint, Microsemi, Actel, Aeroflex, Peregrine, VPT, Syfer, Eurofarad, Texas Instruments, MS Kennedy, Miteq, Cobham, E2V, MA-COM, Hittite, Mini-Circuits, General Dynamics и др.);

Компания «Океан Электроники» является официальным дистрибьютором и эксклюзивным представителем в России одного из крупнейших производителей разъемов военного и аэрокосмического назначения «JONHON», а так же официальным дистрибьютором и эксклюзивным представителем в России производителя высокотехнологичных и надежных решений для передачи СВЧ сигналов «FORSTAR».



## JONHON

«JONHON» (основан в 1970 г.)

Разъемы специального, военного и аэрокосмического назначения:

(Применяются в военной, авиационной, аэрокосмической, морской, железнодорожной, горно- и нефтедобывающей отраслях промышленности)

«FORSTAR» (основан в 1998 г.)

ВЧ соединители, коаксиальные кабели,  
кабельные сборки и микроволновые компоненты:

(Применяются в телекоммуникациях гражданского и специального назначения, в средствах связи, РЛС, а так же военной, авиационной и аэрокосмической отраслях промышленности).



Телефон: 8 (812) 309-75-97 (многоканальный)

Факс: 8 (812) 320-03-32

Электронная почта: [ocean@oceanchips.ru](mailto:ocean@oceanchips.ru)

Web: <http://oceanchips.ru/>

Адрес: 198099, г. Санкт-Петербург, ул. Калинина, д. 2, корп. 4, лит. А