

Time Delay Values (M and Q Series) Dual Rated AC/DC

Instantaneous

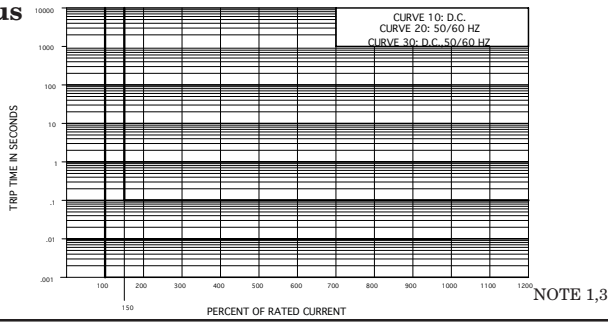

Short

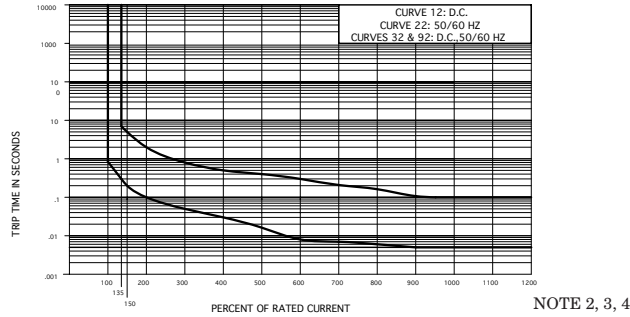

Medium

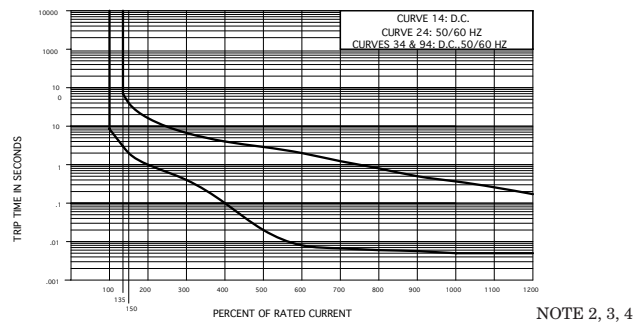

		PERCENT OF RATED CURRENT								
TRIP TIME (SECONDS)	DELAY	100%	135%	150%	200%	400%	600%	800%	1000%	1200%
		10, 20 & 30	NO TRIP	MAY TRIP	.100 MAX.	.100 MAX.	.100 MAX.	.100 MAX.	.100 MAX.	.100 MAX.
	12, 22, 32 & 92	NO TRIP	.300 - 7.00	.200 - 5.00	.100 - 2.00	.030 - .500	.008 - .300	.006 - .150	.005 - .100	.005 - .100
	14, 24, 34 & 94	NO TRIP	3.00 - 70.0	2.00 - 40.0	1.00 - 15.0	.100 - 4.00	.008 - 2.00	.006 - .800	.005 - .350	.005 - .160

NOTES

- 1 Breakers to hold 100% and must trip at 150% of rated current and greater within the time limit shown in this curve.
- 2 Breakers to hold 100% and must trip at 135% of rated current and greater within the time limits shown in this curve.
- 3 Curve data shown represents breaker response at ambient temperature of 77°F (25°C) with no preloading. Breakers are mounted in standard wall mount position.
- 4 The minimum inrush pulse tolerance handling capacity on the above standard delays is 12 times rated current based on a 60 Hz, 1/2 cycle 8 ms pulse for delay curves 22, 24, 32 and 34 and is 18 times rated current up to 20 amps; 14 times rated current up to 25 amps based on a 60Hz, 1/2 cycle 8 ms pulse for delay curves 92 and 94.

Q-Series – Rocker Actuator

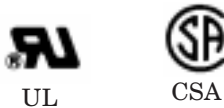

The Q-Series magnetic circuit breakers are designed for those demanding applications where space, aesthetics and snap-in front panel mounting are important. Available in a choice of rocker actuator styles and colors including the Visi-Rocker® two-color actuators as well as non-illuminated or illuminated versions with LED or neon bulbs. The exclusive Rockerguard® bezel helps prevent inadvertent actuation. “Wiping” contact design insures long term reliability. Various styling options allow design flexibility.

1-2 poles, 0.02 to 25 amps, up to 250 VAC or 65 VDC. Available with a choice of time delays, terminals, actuator styles and colors.

Agency Approvals

UL Recognized under the Component Recognition Program as Protectors, Supplementary (Guide QVNU2, File E75596), UL Standard 1077 and Switches, Industrial Control (Guide NRNT2, File E148683), UL Standard 508.

CSA Certified as Supplementary Protectors under Class 3215 01, File LR47848. CSA Standard C 22.2 No. 235.

General Specifications

ELECTRICAL

Table A: Lists UL Recognized and CSA Certified configurations and performance capabilities as a Component Supplementary Protector.

AS A COMPONENT SUPPLEMENTARY PROTECTOR								
CIRCUIT CONFIGURATION	VOLTAGE			CURRENT RATING		POLES BREAKING	INTERRUPTING CAPACITY (AMPS) w/o Backup Fuse UL/CSA	INTERRUPTING CAPACITY (AMPS) w/Backup Fuse UL/CSA
	MAX RATING	FREQUENCY	PHASE	FULL LOAD AMPS ^[1]	GENERAL PURPOSE AMPS ^[2]			
SERIES	32	D.C.	-	0.02 - 15	15.1 - 25	1	1000	-
	50 ^[3]	D.C.	-	-	0.02 - 7.5	1	1000	-
	65	D.C.	-	0.02 - 15	15.1 - 25	2	1000	-
	125	50/60Hz	1	0.02 - 15	15.1 - 25	1	1000	-
	250	50/60Hz	1	0.02 - 12	-	1	1000	-
	250	50/60Hz	1	0.02 - 15	15.1 - 25	2	1000	-
	250 ^[3]	50/60Hz	1	-	12.1 - 18	1	-	1000 ^[4]

Table B: Lists UL Recognized and CSA Certified configurations and performance capabilities as an Industrial Control Switch.

AS AN INDUSTRIAL CONTROL SWITCH							
CIRCUIT CONFIGURATION	VOLTAGE			CURRENT RATING			POLES BREAKING
	MAX RATING	FREQUENCY	PHASE	FULL LOAD AMPS ^[1]	GENERAL PURPOSE AMPS ^[2]	TUNGSTEN LAMP LOAD AMPS	
SWITCH ONLY	32	D.C.	-	15	25	-	1
	50 ^[3]	D.C.	-	-	7.5	-	1
	65	D.C.	-	15	25	-	2
	125	50/60Hz	1	15	25	15	1
	250	50/60Hz	1	12	-	-	1
	250	50/60Hz	1	15	25	-	2

NOTES

- 1 For Motor Load Applications.
- 2 For Non-Motor Load Applications.
- 3 Available under special catalog number only; consult factory.
- 4 Requires Branch Circuit backup with a UL Listed Type K-5 or RK-5 fuse rated 60 amps maximum.

General Specifications (cont.)

Maximum Voltage 125/250 VAC 50/60 Hz, 65 VDC (See Table A)
 Current Ratings Standard current coils: 0.100, 0.250, 0.500, 0.750, 1.00 thru 15.0 in 1 amp increments, 18.0, 20.0, 25.0. Other ratings available - consult factory.
 Auxiliary Switch Rating SPDT; 7 Amps - 250VAC, 7 Amps (Res)-28 VDC, 4 Amps (Ind.)-28 VDC (silver contacts), 0.1 Amps -125VAC (gold contacts).
 Insulation Resistance Minimum of 100 Megohms at 500 VDC.
 Dielectric Strength UL, CSA 1500V, 60 Hz for one minute between all electrically isolated terminals. Q-Series Non-Illuminated Circuit Breakers comply with the 8mm spacing and 3750 V 50/60Hz dielectric requirements from hazardous voltage to operator accessible surfaces, per IEC Publications 380/VDE 0806 and 435/VDE 0805.
 Resistance, Impedance Values from Line to Load Terminal - based on Series Trip Circuit Breaker

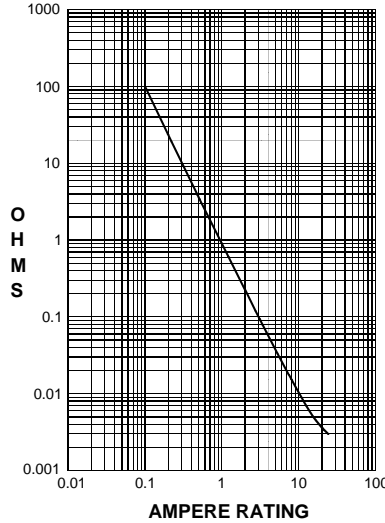

CURRENT (AMPS)	TOLERANCE (%)
0.10 - 20.0	±25
20.1 - 25.0	±35

Pulse Tolerance Curves

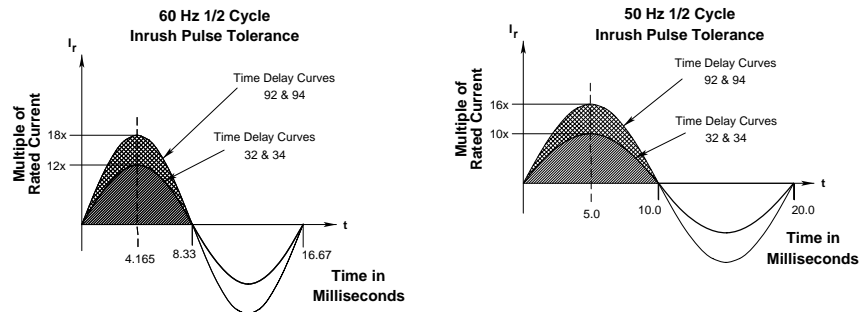

MECHANICAL

Endurance 10,000 ON-OFF operations @ 6 per minute with rated Current and Voltage.
 Trip Free All Q-Series Rocker Type Circuit Breakers will trip on overload, even when rocker is forcibly held in the ON position.

Trip Indication The actuator moves positively to the OFF position when an overload causes the circuit breaker to trip.

ENVIRONMENTAL

Environmental Designed and tested in accordance with requirements of specification MIL-C- 55629 and MIL-STD-202 as follows:

Shock Withstands 100 Gs, 6ms, sawtooth while carrying rated current per Method 213, Cond. I. Instantaneous curves tested at 80% of rated current.

Vibration Withstands 0.060" excursion from 10-55 Hz, and 10 Gs 55-500 Hz, at rated current per Method 204C, Test Condition A. Instantaneous curves tested at 80% of rated current.

Moisture Resistance Method 106D, i.e., ten 24-hour cycles @ + 25°C to +65°C, 80-98% RH.

Salt Spray Method 101, Condition A (90-95% RH @ 5% NaCl Solution, 96 hrs).

Thermal Shock Method 107D, Condition A (Five cycles @ -55°C to +25°C to +85°C to +25°C).

Operating Temperature -40° C to +85° C

Chemical Resistance Only the outside surfaces of the case and the rockers may be cleaned with detergents or alcohol. Organic (hydrocarbon based) solvents are not recommended because they attack plastics. Caution should be taken when solvents are used to clean and remove flux from terminals. Lubricants should not be introduced into the rocker/bezel openings.

PHYSICAL

Number of Poles 1 or 2

Internal Circuit Configurations Series with or without Auxiliary Switch and Rocker Illumination. Switch Only with or without Auxiliary Switch and Rocker Illumination.

Weight Approximately 34 grams/pole (Approximately 1.2 ounces/pole)

Standard Colors Housing-Black, White or Gray; Actuator- See Ordering Scheme.

Circuit and Terminal Diagrams

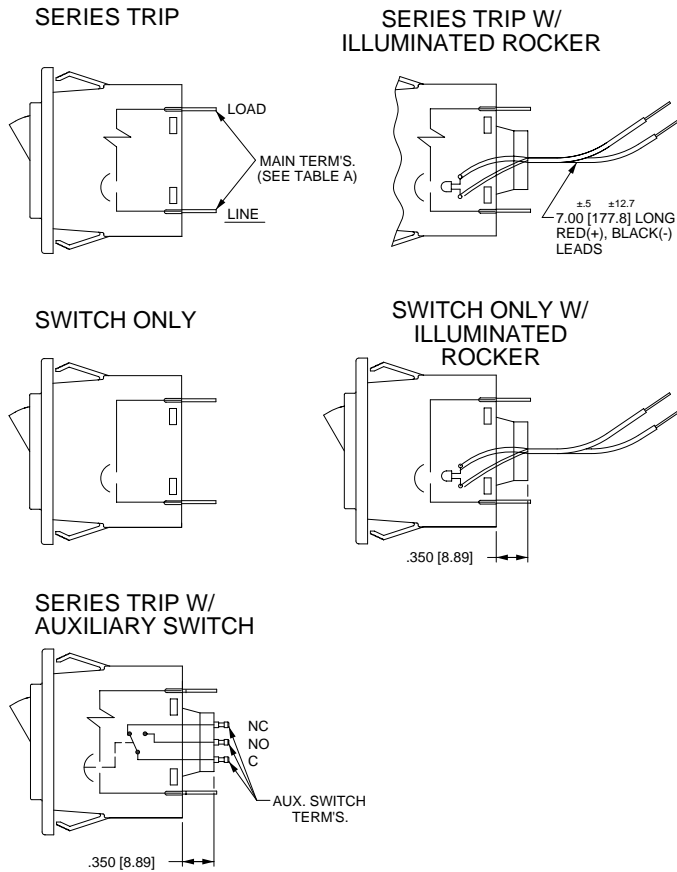

TERMINAL DIMENSIONAL DETAIL

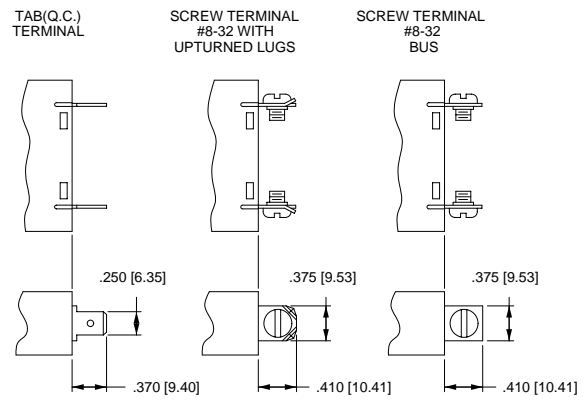

AUXILIARY SWITCH TERMINALS

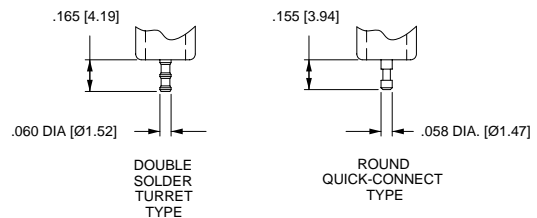

MULTI-POLE IDENTIFICATION SCHEME

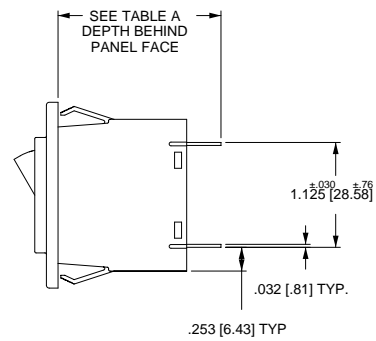
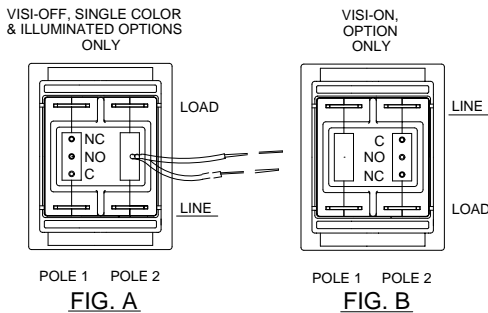

TABLE - A		
TERMINAL DESCRIPTION		DEPTH BEHIND PANEL FACE
MAIN	TAB (Q.C.)	1.750 / 44.45
	SCREW (#8-32)	1.790 / 45.47
AUX.* SWITCH	DOUBLE SOLDER TURRET TYPE	1.895 / 48.13
	ROUND Q.C. TYPE	1.885 / 47.88

*AUX. SWITCH IS NOT AVAILABLE ON SINGLE POLE ILLUMINATED UNITS. WHEN CALLED FOR ON MULTI-POLE UNITS, ONLY ONE AUX SWITCH IS NORMALLY SUPPLIED, MOUNTED AS SHOWN IN FIG. A OR FIG. B.

NOTES

- All dimensions are in inches [millimeters].
- Tolerance ± 0.015 [.38] unless otherwise specified.

Form and Fit Drawings

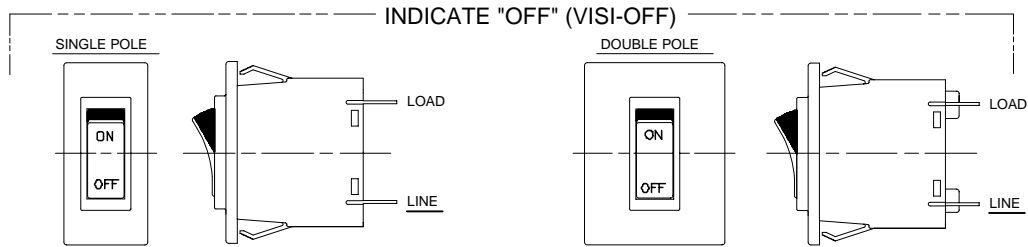
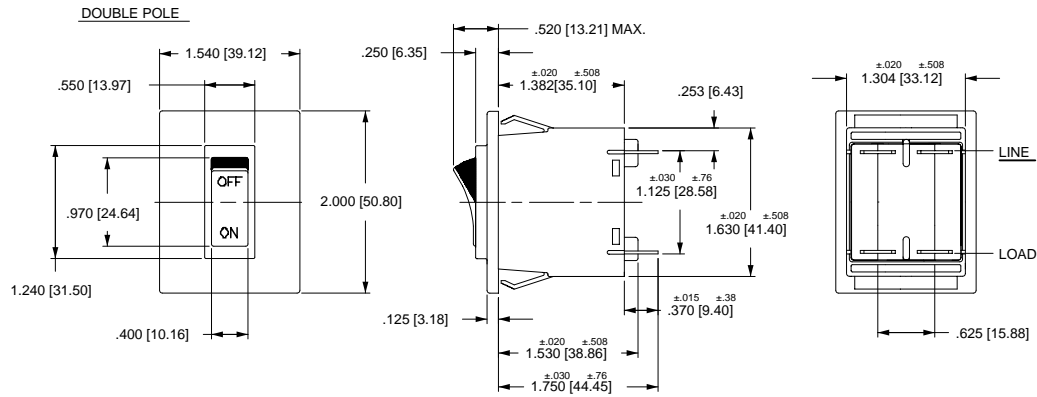
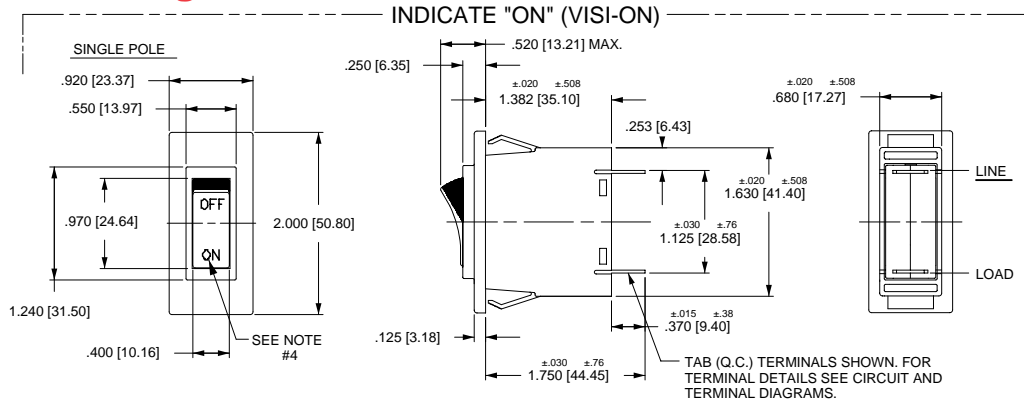

SINGLE COLOR
ANGLED ROCKER STYLE

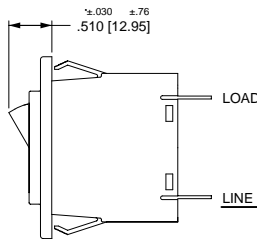

FLAT ROCKER STYLE

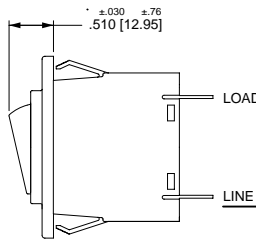

ROCKERGUARD CONFIGURATION
DIMENSIONS ALSO APPLY TO DOUBLE POLE

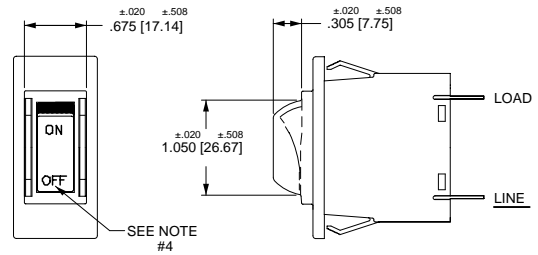

PANEL CUT-OUT DETAIL

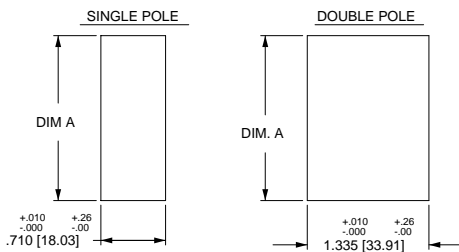

PANEL THICKNESS	DIM. A ±.005 [±.13]
.062 [1.57]	1.775 [45.09]
.093 [2.36]	1.810 [45.97]
.125 [3.18]	1.850 [46.99]

NOTES

- All dimensions are in inches [millimeters].
- Tolerance ±.015 [.38] unless otherwise specified.

Ordering Scheme

PROD CODE

Q

POLES

1 One
2 Two

FREQUENCY & DELAY

03^s No Delay Applicable
DC, 50/60Hz "Switch Only" circuit option
30 DC, 50/60Hz Instant
32 DC, 50/60Hz Short
34 DC, 50/60Hz Medium
92 DC, 50/60 Hz Short High Inrush
94 DC, 50/60Hz Medium High Inrush

Figure G

ROCKER STYLE DESCRIPTION (DUAL LEGEND SHOWN)				
STYLE	INDICATE - "ON" (CODE-D)	INDICATE - "OFF" (CODE-E)	FLAT (CODES-B & G)	ANGLED (CODES-A & F)
VERTICAL				
HORIZONTAL				

Q G 2 - B - 34 -

ACTUATOR¹

NON-ILLUMINATED ROCKER
SINGLE COLOR

A Angled
B Flat

VISI-ROCKER

D Indicate ON
E Indicate OFF

ILLUMINATED ROCKER

F Angled
G Flat

CIRCUIT

WITHOUT AUXILIARY SWITCH

A^s Switch Only (No Coil)/Maintained Contacts
B Series Trip (Current Coil)

Circuit

WITH AUXILIARY SWITCH - SILVER CONTACTS²

	Aux. Switch Term. Type
P^s Switch Only (Maintained Contacts)	.060 Dia. Dbl. Solder Turret
Q^s Switch Only (Maintained Contacts)	.058 Dia. Round Q.C. ⁹
S Series Trip (Current Coil)	.060 Dia. Dbl. Solder Turret
T Series Trip (Current Coil)	.058 Dia. Round Q.C. ⁹

WITH AUXILIARY SWITCH - GOLD CONTACTS²

2^s Switch Only (Maintained Contacts)	.058 Dia. Round Q.C. ⁹
4 Series Trip (Current Coil)	.058 Dia. Round Q.C. ⁹

NOTES

- Angled Rocker Style: Flat Rocker Style: Visi-Rocker Style:
One rocker per unit is provided in center of bezel. Unless otherwise specified, all rocker styles have matte finish.
- Auxiliary Switch is not available on single pole illuminated styles.
- This is only a partial listing of the many amp ratings available. For other ratings, please consult factory.
- For neon bulb applications at 120VAC, a 47K, 1/4 WATT, external resistor must be supplied by customer. For 250 VAC applications, a 150K 1/4 WATT, external resistor must be supplied by customer.
- For LED (DC or rectified AC) applications the LED is supplied mounted in the center of the rocker actuator with electrical characteristics as follows: 100 millicandela at 20 mA; Maximum power dissipation = 75 mW at 25°C; Typical forward voltage = 2.1V at 20mA; Typical reverse current = 100 uA at 3V; **Note: Customer is required to supply the proper external resistor limiting current to above values.**
- When visi-rocker is specified, the visi portion of the rocker can not be the same color as the bezel. The remainder of the rocker, however, will be the same color as the bezel. A legend is mandatory on all visi-rockers.
- If legend not desired, choose Rocker Legend Type Code 1.
- For "switch only" (no coil) version, select Current Coil Rating Code from table B on page 28.
- Mates with AMP: .058 inch Dia. Pin Receptacles; P/N's 61983-1 (gold plated) and 61986-1 (tin plated).
- Rocker color for LED's and green neon lamp must be clear, smoke gray, white translucent, or match color of LED or lamp.
- Dual = I-O / ON-OFF combination.
- Consult factory for VDE Certified versions.

TERMINAL

1	Push-On 0.250 Tab (Q.C.)
2	Screw 8-32 w/upturned lugs
3	Screw 8-32 (Bus Type)

ROCKER & LEGEND COLORS

ILLUMINATED ROCKER¹⁰

ROCKER	LEGEND ⁷
A Clear	White
B Red Transparent	White
C Green Transparent	White
D Amber Transparent	White
E Smoke Gray Transparent	White
F White Translucent	Black

**NON-ILLUMINATED ROCKER
SINGLE COLOR**

ROCKER	LEGEND ⁷
1 White	Black
2 Black	White
3 Red	White
8 Orange	Black

**VISI-ROCKER
VISI⁶ & LEGEND**

VISI ⁶ & LEGEND	ROCKER ⁶
1 White	[Remainder of rocker same color as bezel]
2 Black	
3 Red	
4 Green	

BEZEL COLOR/STYLE⁶

WITHOUT ROCKERGUARD

A	White
B	Black
G	Gray

WITH ROCKERGUARD

1	White
2	Black
7	Gray

620 - 1 - H C 6 - 7 - C

**CURRENT
COIL RATING³**
(amperes)

210	0.100
225	0.250
250	0.500
275	0.750
410	1.000
420	2.000
425	2.500
430	3.000
440	4.000
450	5.000
460	6.000
470	7.000
475	7.500
480	8.000
490	9.000
610	10.000
611	11.000
612	12.000
613	13.000
614	14.000
615	15.000
618	18.000
620	20.000
625	25.000

ROCKER ILLUMINATION

A	NON-ILLUMINATED (single color & Visi-Rocker options only)
B⁴	Neon (w/o resistor) 120VAC/250VAC
C^{4,10}	Green Glow Neon (w/o resistor) 120VAC/250VAC
D^{5,10}	Red LED (w/o resistor)
E¹⁰	Red LED (w/ resistor) 4-8 VDC
F¹⁰	Red LED (w/ resistor) 9-16 VDC
G^{5,10}	Green LED (w/o resistor)
H¹⁰	Green LED (w/ resistor) 4-8 VDC
J¹⁰	Green LED (w/ resistor) 9-16 VDC
K^{5,10}	Amber LED (w/o resistor)
L¹⁰	Amber LED (w/ resistor) 4-8 VDC
M¹⁰	Amber LED (w/ resistor) 9-16 VDC

ROCKER LEGEND¹¹

1	No legend (Single color or illuminated rocker options only)
2	ON-OFF Vertical
3	ON-OFF Horizontal
4	I-O Vertical
5	I-O Horizontal
6	Dual Vertical
7	Dual Horizontal

AGENCY APPROVAL¹²

A	W/O Approval
B	UL Recognized
C	UL Recognized; CSA Certified

Q-Series – Supplementary Drawings

ROCKER AND AUXILIARY SWITCH OPTIONS:

AVAILABLE CIRCUIT OPTIONS:

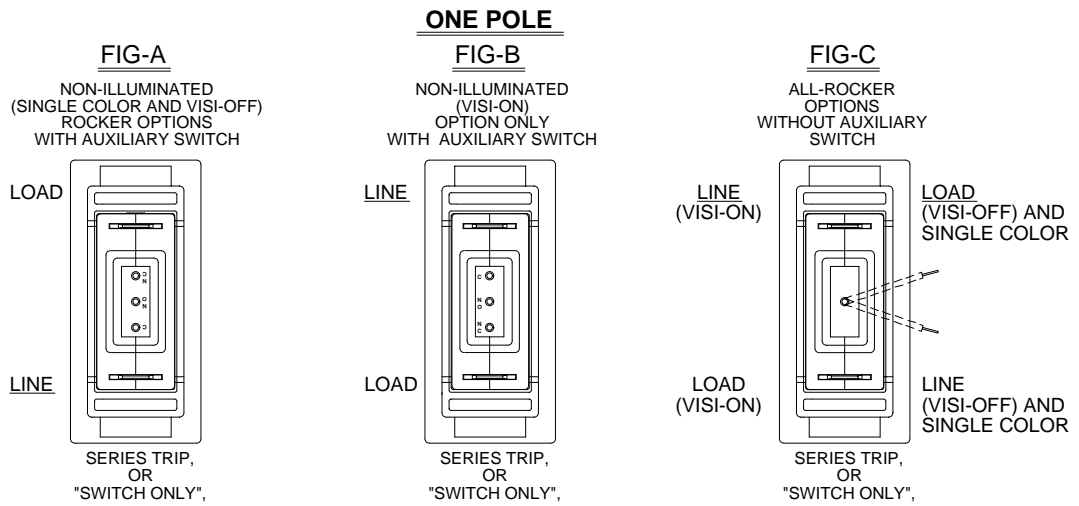

ROCKER AND AUXILIARY SWITCH OPTIONS:

AVAILABLE CIRCUIT OPTIONS:

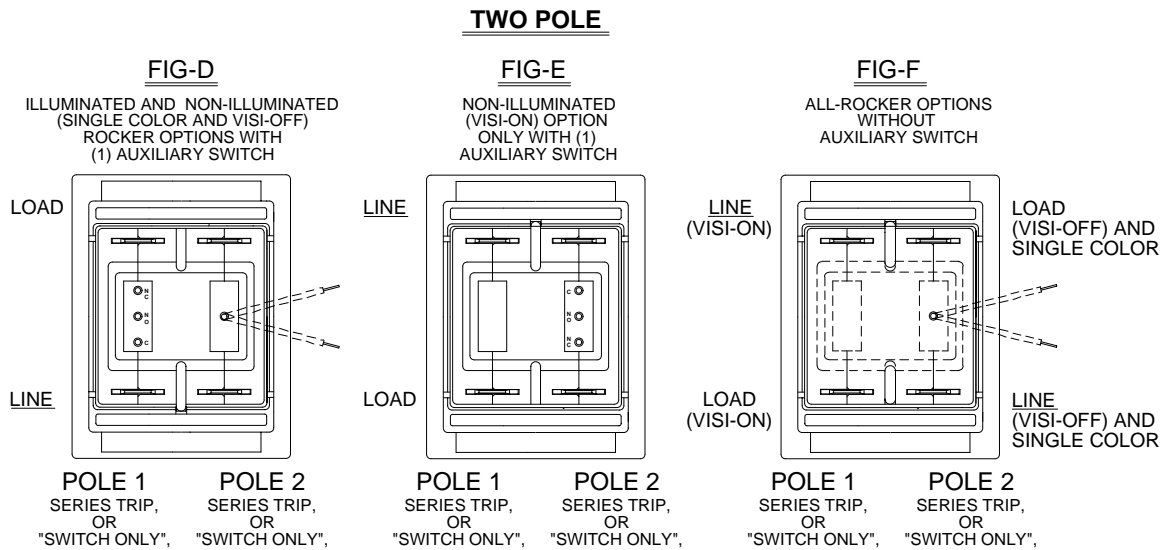

MULTI-POLE BREAKERS ARE AVAILABLE WITH A MAXIMUM OF 1 AUXILIARY SWITCH MOUNTED AS SHOWN ABOVE

FIG-G

ROCKER STYLE DESCRIPTION
(DUAL LEGEND SHOWN)

STYLE	INDICATE - "ON" (CODE-D)	INDICATE - "OFF" (CODE-E)	FLAT (CODES - B & G)	ANGLED (CODES - A & F)
VERTICAL				
HORIZONTAL				

FIG-H

POLE DESIGNATIONS
FOR HORIZONTAL MOUNTING / LEGEND ALL ROCKER STYLES

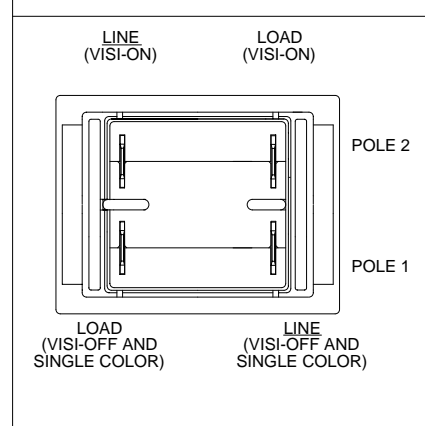

Компания «Океан Электроники» предлагает заключение долгосрочных отношений при поставках импортных электронных компонентов на взаимовыгодных условиях!

Наши преимущества:

- Поставка оригинальных импортных электронных компонентов напрямую с производств Америки, Европы и Азии, а так же с крупнейших складов мира;
- Широкая линейка поставок активных и пассивных импортных электронных компонентов (более 30 млн. наименований);
- Поставка сложных, дефицитных, либо снятых с производства позиций;
- Оперативные сроки поставки под заказ (от 5 рабочих дней);
- Экспресс доставка в любую точку России;
- Помощь Конструкторского Отдела и консультации квалифицированных инженеров;
- Техническая поддержка проекта, помощь в подборе аналогов, поставка прототипов;
- Поставка электронных компонентов под контролем ВП;
- Система менеджмента качества сертифицирована по Международному стандарту ISO 9001;
- При необходимости вся продукция военного и аэрокосмического назначения проходит испытания и сертификацию в лаборатории (по согласованию с заказчиком);
- Поставка специализированных компонентов военного и аэрокосмического уровня качества (Xilinx, Altera, Analog Devices, Intersil, Interpoint, Microsemi, Actel, Aeroflex, Peregrine, VPT, Syfer, Eurofarad, Texas Instruments, MS Kennedy, Miteq, Cobham, E2V, MA-COM, Hittite, Mini-Circuits, General Dynamics и др.);

Компания «Океан Электроники» является официальным дистрибьютором и эксклюзивным представителем в России одного из крупнейших производителей разъемов военного и аэрокосмического назначения «JONHON», а так же официальным дистрибьютором и эксклюзивным представителем в России производителя высокотехнологичных и надежных решений для передачи СВЧ сигналов «FORSTAR».



JONHON

«JONHON» (основан в 1970 г.)

Разъемы специального, военного и аэрокосмического назначения:

(Применяются в военной, авиационной, аэрокосмической, морской, железнодорожной, горно- и нефтедобывающей отраслях промышленности)

«FORSTAR» (основан в 1998 г.)

ВЧ соединители, коаксиальные кабели,
кабельные сборки и микроволновые компоненты:

(Применяются в телекоммуникациях гражданского и специального назначения, в средствах связи, РЛС, а так же военной, авиационной и аэрокосмической отраслях промышленности).



Телефон: 8 (812) 309-75-97 (многоканальный)

Факс: 8 (812) 320-03-32

Электронная почта: ocean@oceanchips.ru

Web: <http://oceanchips.ru/>

Адрес: 198099, г. Санкт-Петербург, ул. Калинина, д. 2, корп. 4, лит. А