

### DESCRIPTION

The MP8847 is a highly integrated and high frequency synchronous step-down switcher with I<sup>2</sup>C control interface. It is optimized to support up to 6A load current over an input supply range from 2.7V to 6V with excellent load and line regulation.

Constant frequency hysteretic mode provides extremely fast transient response without loop compensation and easily achieves high efficiency under light load condition.

The output voltage level can be controlled, on-the fly through a 3.4Mbps I<sup>2</sup>C serial interface. Voltage range can be adjusted from 0.6V to 1.235V in 5mV steps.

Voltage slew rate, switching frequency and power savings mode are also selectable through the I<sup>2</sup>C interface.

The MP8847 requires a minimum number of readily available standard external components and is available in the compact QFN 2mmx3mm package.

### ELECTRICAL SPECIFICATION

Parameter	Symbol	Value	Units
Input Voltage	V <sub>IN</sub>	2.7– 6	V
Output Voltage	V <sub>OUT</sub>	0.95	V
Output Current	I <sub>OUT</sub>	6	A

### FEATURES

- 2.7V to 6V Input Voltage Range
- Up to 6A Load Current
- Internal 35mΩ High-Side, 15mΩ Low-Side Power MOSFETs
- I<sup>2</sup>C Compatible Interface up to 3.4Mbps
- I<sup>2</sup>C Programmable Output Range from 0.6V to 1.235V in 5mV Steps
- Factory Adjustable Switching Frequency from 0.85MHz to 2.2MHz
- Power Saving Mode Selectable via I2C
- Internal 1ms Soft-Start
- Power Good Indicator
- Current Overload and Thermal Shutdown Protection
- Available in QFN 2mmx3mm package

### APPLICATIONS

- Processor Core Supply
- Micro Converter

All MPS parts are lead-free and adhere to the RoHS directive. For MPS green status, please visit MPS website under Products, Quality Assurance page.

"MPS" and "The Future of Analog IC Technology" are registered trademarks of Monolithic Power Systems, Inc.

### EV8847-D-00A EVALUATION BOARD



Board Number	MPS IC Number
EV8847-D-00A	MP8847GD

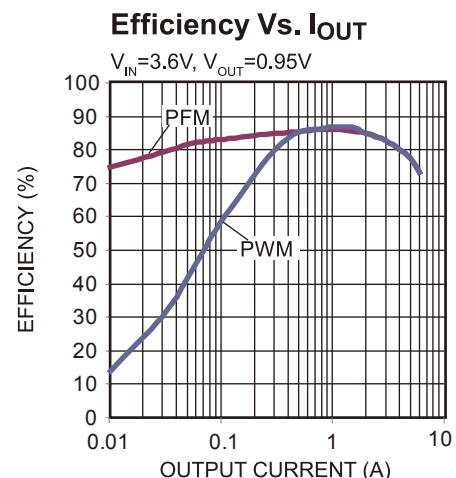

## EVALUATION BOARD SCHEMATIC

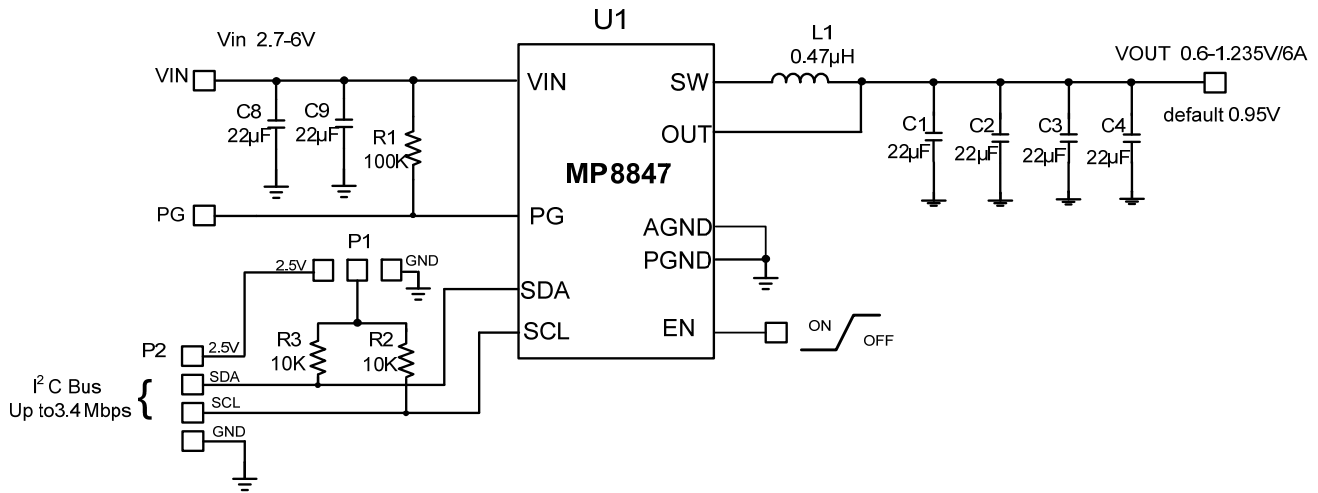

## EV8847-D-00A BILL OF MATERIALS

Qty	RefDes	Value	Description	Package	Manufacturer	Manufacturer P/N
4	C1, C2, C3, C4	22µF	Ceramic Cap, 6.3V, X5R	SM0805	muRata	GRM21BR60J226ME39L
2	C8, C9	22µF	Ceramic Cap, 10V, X5R	SM0603	muRata	GRM21BD71A226ME44L
3	C5, C6, C7	NS				
1	R1	100k	Film Res., 5%	SM0603	Any	
2	R2, R3	10k	Film Res., 5%	SM0603	Any	
1	L1	0.47µH	Inductor IR=6.8A, Isat=14.5A	SM 4.0X4.0mm	Würth	744 373 240 047
1	U1	MP8847	Step Down Switcher With I2C	QFN-2mmx3mm	MPS	MP8847DG

## EVB TEST RESULTS

Performance waveforms are tested on the evaluation board.

$V_{IN} = 5V$ ,  $V_{OUT} = 0.95V$ ,  $L = 0.47\mu H$ ,  $T_A = 25^\circ C$ , unless otherwise noted.

**Quiescent Current vs. Input Voltage**

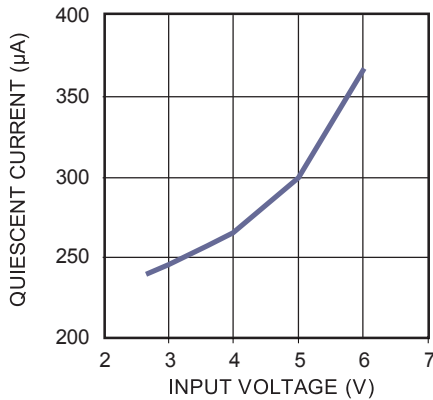

**Shutdown Current vs. Input voltage**

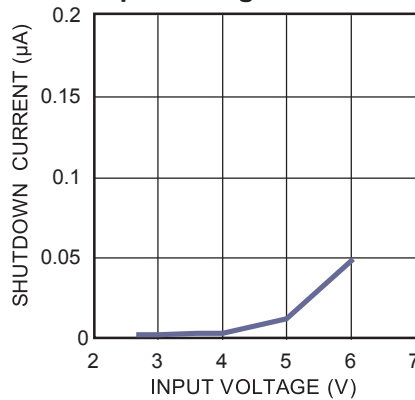

**Lowest Vout vs. Temperature**

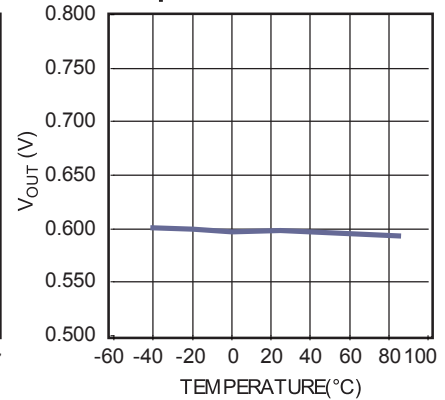

**Highest  $V_{OUT}$  vs. Temperature**

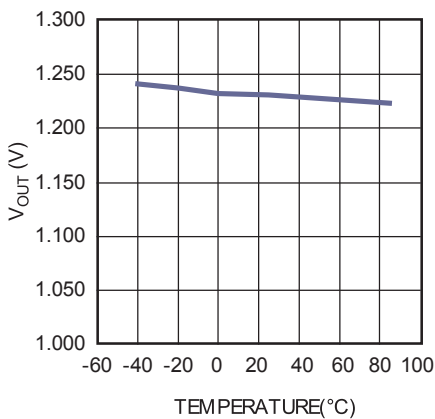

**$V_{IN}$  UVLO Rising and Falling Threshold vs. Temperature**

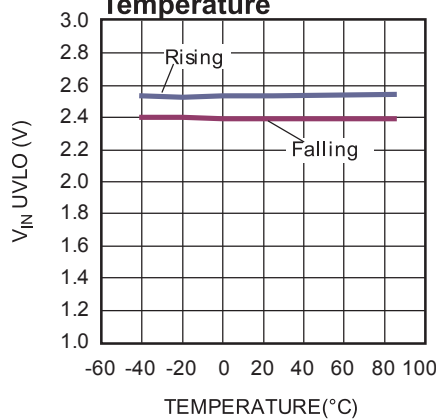

**EN Rising and Falling Threshold vs. Temperature**

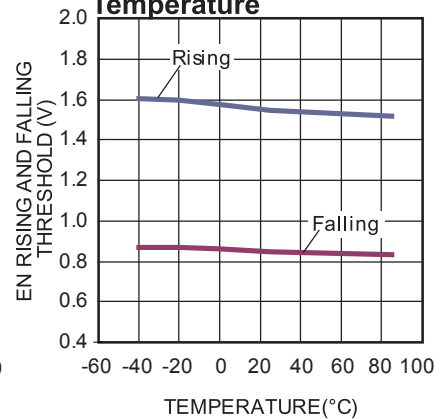

**Efficiency Vs.  $I_{OUT}$**

$V_{IN} = 5V$ ,  $V_{OUT} = 0.95V$

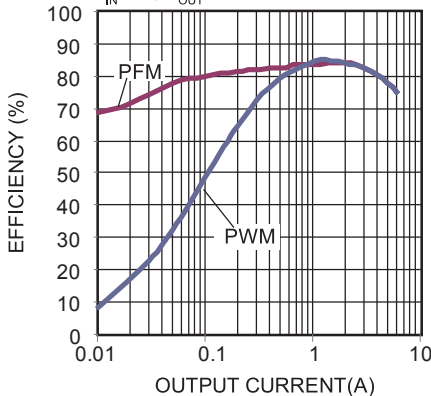

**Efficiency Vs.  $I_{OUT}$**

$V_{IN} = 3.6V$ ,  $V_{OUT} = 0.95V$

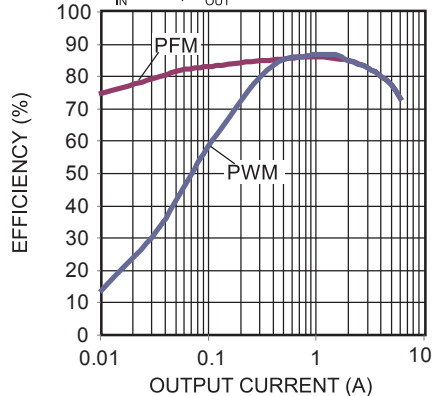

**Load Regulation Vs.  $I_{OUT}$**

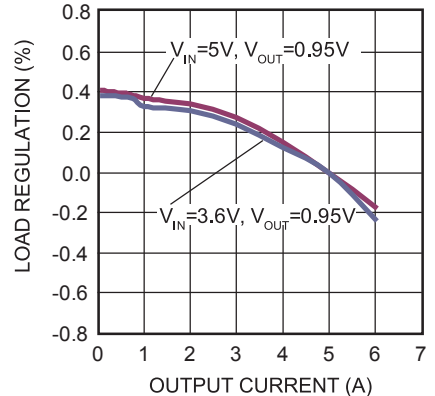

## EVB TEST RESULTS *(continued)*

Performance waveforms are tested on the evaluation board.

$V_{IN} = 5V$ ,  $V_{OUT} = 0.95V$ ,  $L = 0.47\mu H$ ,  $T_A = 25^\circ C$ , unless otherwise noted.

**Output Ripple**

$I_{OUT} = 0A$

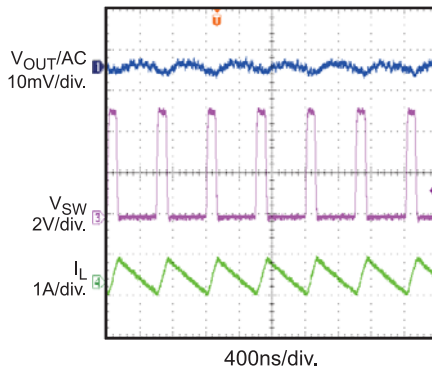

**Output Ripple**

$I_{OUT} = 2A$

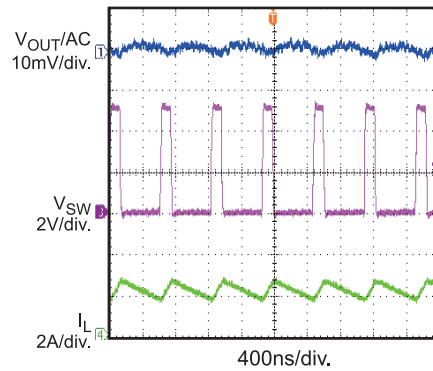

**Output Ripple**

$I_{OUT} = 5A$

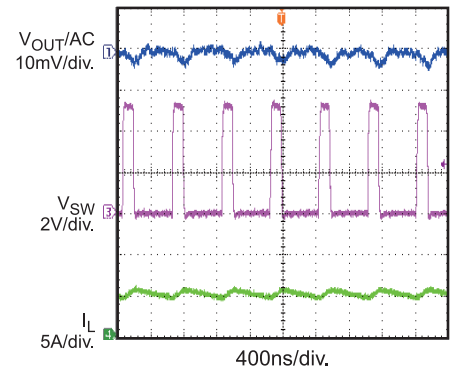

**Output Ripple**

PFM Mode

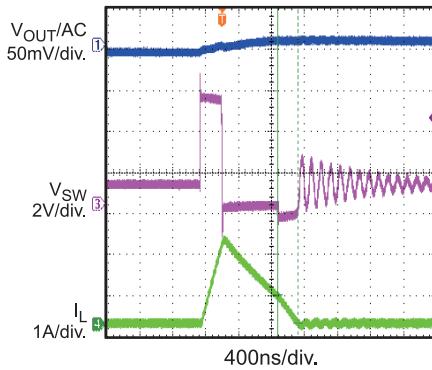

**V<sub>IN</sub> Power Up**

$I_{OUT} = 0A$

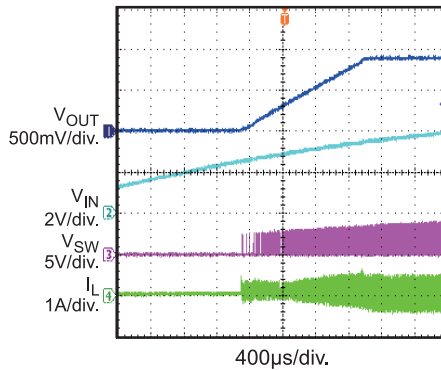

**V<sub>IN</sub> Power Up**

$I_{OUT} = 5A$

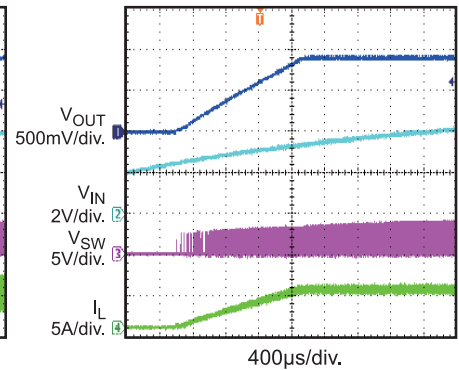

**V<sub>IN</sub> Power Down**

$I_{OUT} = 0A$

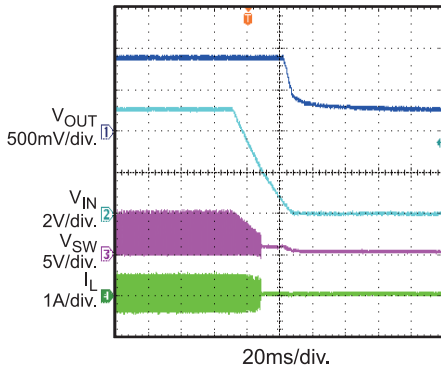

**V<sub>IN</sub> Power Down**

$I_{OUT} = 5A$

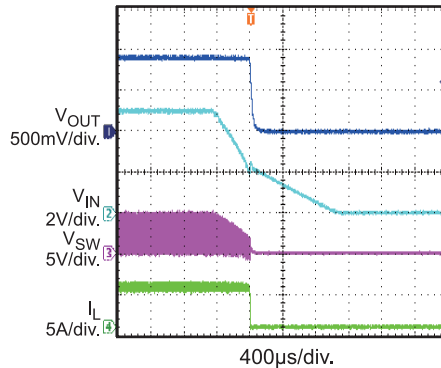

**EN On**

$I_{OUT} = 0A$

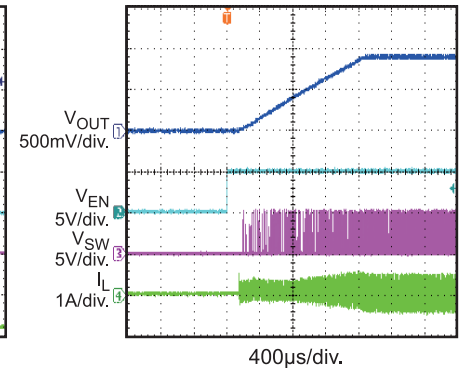

**EVB TEST RESULTS (continued)**

Performance waveforms are tested on the evaluation board.

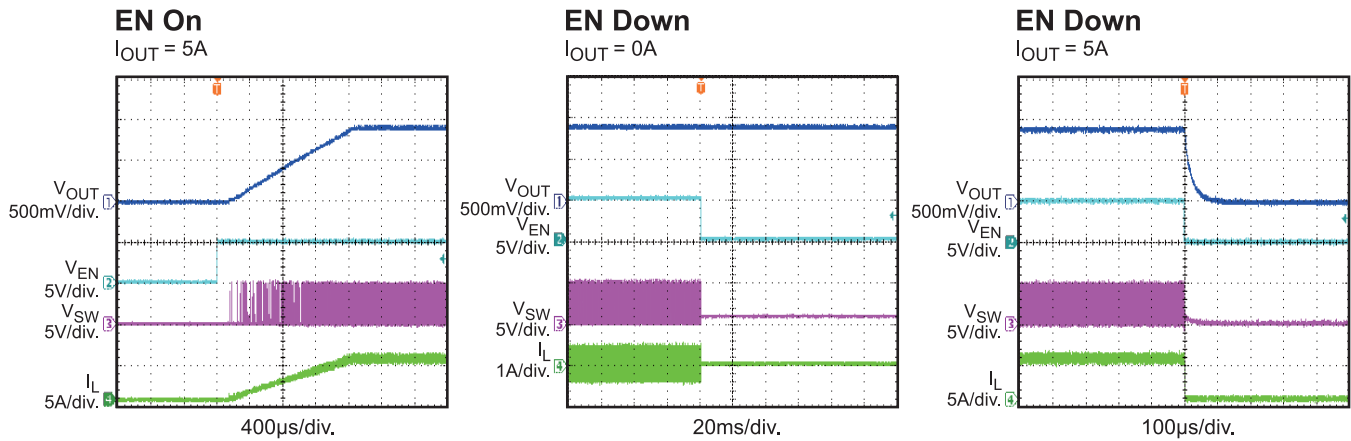
 $V_{IN} = 5V$ ,  $V_{OUT} = 0.95V$ ,  $L = 0.47\mu H$ ,  $T_A = 25^\circ C$ , unless otherwise noted.

## PRINTED CIRCUIT BOARD LAYER

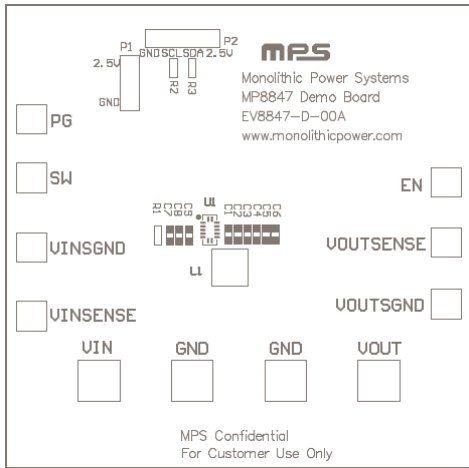

Figure 1: Top Silk Layer

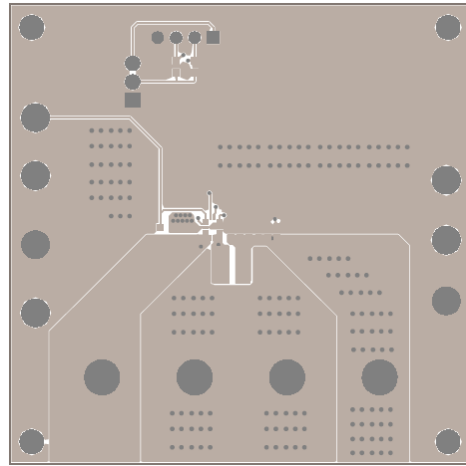

Figure 2: Top Layer

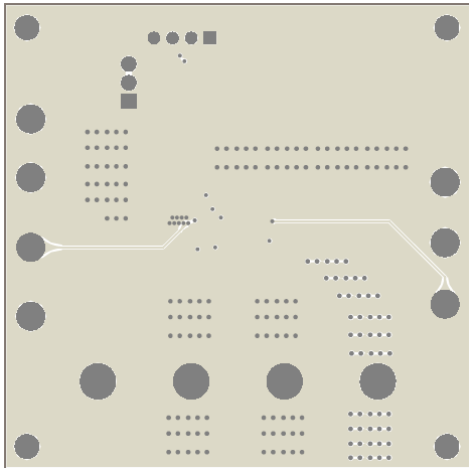

Figure 3: Internal Layer1

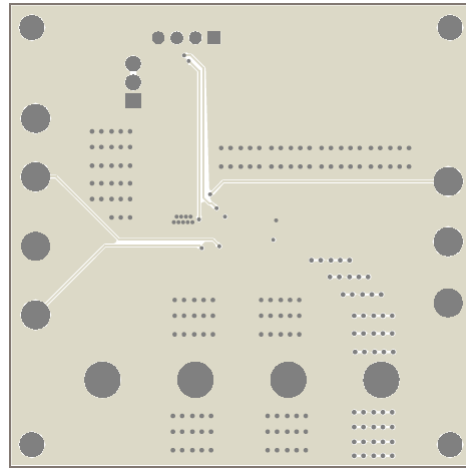

Figure 4: Internal Layer2

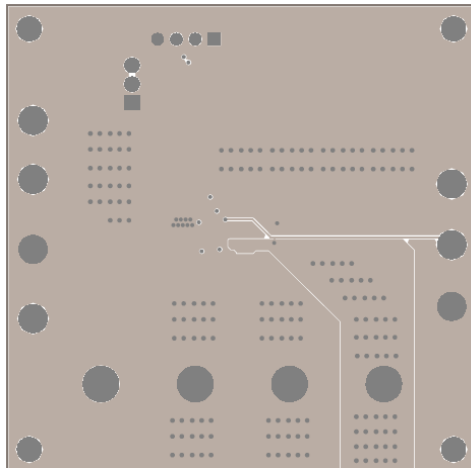

Figure 5: Bottom Layer

## QUICK START GUIDE

1. Connect the positive and negative terminals of the load to the VOUT and GND pins, respectively.
2. Preset the power supply output between 2.7V and 6V, and then turn off the power supply.
3. Connect the positive and negative terminals of the power supply output to the VIN and GND pins, respectively.
4. Turn the power supply on and make EN voltage more than threshold. The board will automatically start up.
5. Refer to MPS IIC Interface System user manual for I<sup>2</sup>C application.

## LAYOUT RECOMMENDATION OF MP8847

Proper layout of the switching power supplies is very important, and sometimes critical to make it work properly. Especially, for the high switching frequency converter, if the layout is not carefully done, the regulator could show poor line or load regulation, stability issues.

**NOTICE:** The information in this document is subject to change without notice. Please contact MPS for current specifications. Users should warrant and guarantee that third party Intellectual Property rights are not infringed upon when integrating MPS products into any application. MPS will not assume any legal responsibility for any said applications.

Компания «Океан Электроники» предлагает заключение долгосрочных отношений при поставках импортных электронных компонентов на взаимовыгодных условиях!

Наши преимущества:

- Поставка оригинальных импортных электронных компонентов напрямую с производств Америки, Европы и Азии, а так же с крупнейших складов мира;
- Широкая линейка поставок активных и пассивных импортных электронных компонентов (более 30 млн. наименований);
- Поставка сложных, дефицитных, либо снятых с производства позиций;
- Оперативные сроки поставки под заказ (от 5 рабочих дней);
- Экспресс доставка в любую точку России;
- Помощь Конструкторского Отдела и консультации квалифицированных инженеров;
- Техническая поддержка проекта, помощь в подборе аналогов, поставка прототипов;
- Поставка электронных компонентов под контролем ВП;
- Система менеджмента качества сертифицирована по Международному стандарту ISO 9001;
- При необходимости вся продукция военного и аэрокосмического назначения проходит испытания и сертификацию в лаборатории (по согласованию с заказчиком);
- Поставка специализированных компонентов военного и аэрокосмического уровня качества (Xilinx, Altera, Analog Devices, Intersil, Interpoint, Microsemi, Actel, Aeroflex, Peregrine, VPT, Syfer, Eurofarad, Texas Instruments, MS Kennedy, Miteq, Cobham, E2V, MA-COM, Hittite, Mini-Circuits, General Dynamics и др.);

Компания «Океан Электроники» является официальным дистрибьютором и эксклюзивным представителем в России одного из крупнейших производителей разъемов военного и аэрокосмического назначения «JONHON», а так же официальным дистрибьютором и эксклюзивным представителем в России производителя высокотехнологичных и надежных решений для передачи СВЧ сигналов «FORSTAR».



## JONHON

«JONHON» (основан в 1970 г.)

Разъемы специального, военного и аэрокосмического назначения:

(Применяются в военной, авиационной, аэрокосмической, морской, железнодорожной, горно- и нефтедобывающей отраслях промышленности)

«FORSTAR» (основан в 1998 г.)

ВЧ соединители, коаксиальные кабели,  
кабельные сборки и микроволновые компоненты:

(Применяются в телекоммуникациях гражданского и специального назначения, в средствах связи, РЛС, а так же военной, авиационной и аэрокосмической отраслях промышленности).



Телефон: 8 (812) 309-75-97 (многоканальный)

Факс: 8 (812) 320-03-32

Электронная почта: [ocean@oceanchips.ru](mailto:ocean@oceanchips.ru)

Web: <http://oceanchips.ru/>

Адрес: 198099, г. Санкт-Петербург, ул. Калинина, д. 2, корп. 4, лит. А