

Product Description

The QPC3223 is a 2-bit digital step attenuator (DSA) that features high linearity over the entire 18 dB gain control range in 6 dB steps. The QPC3223 uses a parallel control interface and has a low insertion loss of 0.8 dB at 2 GHz. The patented circuit architecture provides overshoot-free transient switching performance using a single +3 V to +5 V power supply.

The QPC3223 is available in an industry standard 12 pad 3 mm x 3 mm QFN package that is lead-free and RoHS-compliant

Functional Block Diagram

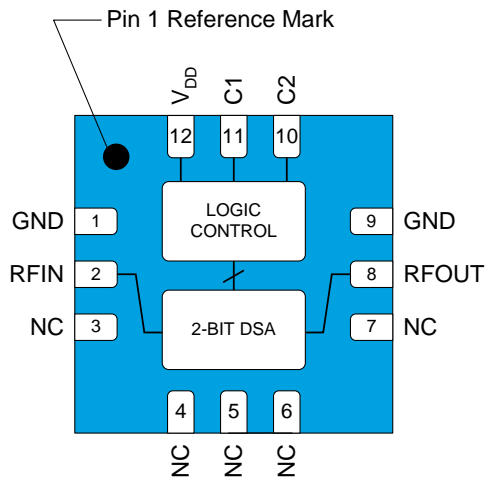

Top View

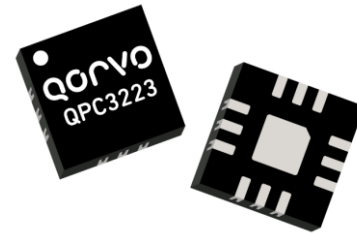

12 Pad 3.0 mm x 3.0 mm QFN package

Product Features

- Frequency Range 50 MHz to 6000 MHz
- 2-Bit, 18 dB Range, 6 dB Step
- Overshoot-free Transient Switching Performance
- High Linearity, Input IP3 > +55 dBm
- Parallel Control Interface
- Fast Switching Speed, 80 nsec Typical
- Single Supply +3 V to +5 V Operation
- 1.8V Logic Compatible
- RF Pins Have No DC Voltage, Can be DC Grounded Externally
- Patented Circuit Architecture
- Power-up Default Setting Is Maximum Attenuation

Applications

- 2G through 4G Base Stations
- Point-to-Point
- Wi-Fi
- Test Equipment

Ordering Information

Part No.	Description
QPC3223TR7	2500 pieces on a 7" reel
QPC3223PCK401	50 – 6000 MHz PCBA w/5-pc. sample bag

Absolute Maximum Ratings

Parameter	Rating
Storage Temperature	-40 to +150 °C
Supply Voltage (V _{DD})	-0.5 to +6.0 V
All Other DC and Logic Pins (Supply Voltage Must Be Applied Prior to Any Other Pin Voltages)	-0.5 to +6.0 V
Input Power (RFIN Pin, +85°C Case Temp.)	+30 dBm
Input Power (RFIN Pin, +105°C Case Temp.)	+27 dBm
Input Power (RFOUT Pin, +85°C Case Temp.)	+27 dBm
Input Power (RFOUT Pin, +105°C Case Temp.)	+24 dBm

Exceeding any one or a combination of the Absolute Maximum Rating conditions may cause permanent damage to the device. Extended application of Absolute Maximum Rating conditions to the device may reduce device reliability.

Recommended Operating Conditions

Parameter	Min	Typ	Max	Units
Supply Voltage (V _{DD})	+2.7		+5.5	V
Case Temperature	-40		+105	°C
Operating Junction Temp.			+125	°C

Electrical specifications are measured at specified test conditions. Specifications are not guaranteed over all recommended operating conditions.

Electrical Specifications

Parameter	Conditions	Min	Typ	Max	Units
Frequency Range		50		6000	MHz
Insertion Loss	2000 MHz, 0 dB Attenuation Setting		0.8		dB
Attenuation Range	0.25 dB step size		18		dB
Attenuation Step			6		dB
Attenuation Accuracy		± (0.2 + 4% of Atten. Setting)			dB
Input IP3			+55		dBm
Input P0.1dB			+30		dBm
RF Input Power at RFIN Pin	Continuous operation at +85 °C case temperature			+27	dBm
	Continuous operation at +105 °C case temperature			+24	dBm
RF Input Power at RFOUT Pin	Continuous operation at +85 °C case temperature			+20	dBm
	Continuous operation at +105 °C case temperature			+17	dBm
Return Loss			15		dB
Input and Output Impedance			50		Ω
Switching Speed	50% CTL to 10% / 90% RF		80		ns
Supply Current, I _{DD}	Steady state operation, current draw during attenuation state transitions is higher.		180		μA
Thermal Resistance	At maximum attenuation state with RF power applied to the RFIN pin		62		°C/W

Notes:

1. Test conditions unless otherwise noted: V_{DD}=+5 V, Temp= +25 °C, Freq.=2000 MHz, 50 Ω system,

Control Logic Requirements

Parameter	Conditions	Min	Typ	Max	Units
Low State Input Voltage		-0.2		+0.63	V
High State Input Voltage		+1.17		V _{DD}	V

Notes:

1. Test conditions unless otherwise noted: V_{DD}=+5 V, Temp= +25 °C, Freq.=2000 MHz, 50 Ω system,

Typical Performance Plots

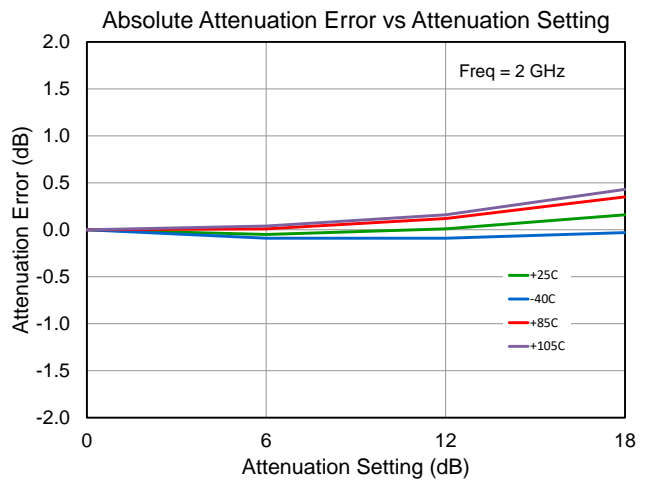
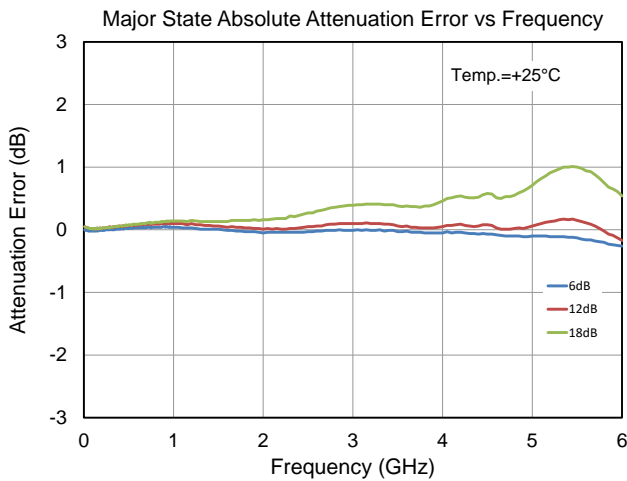
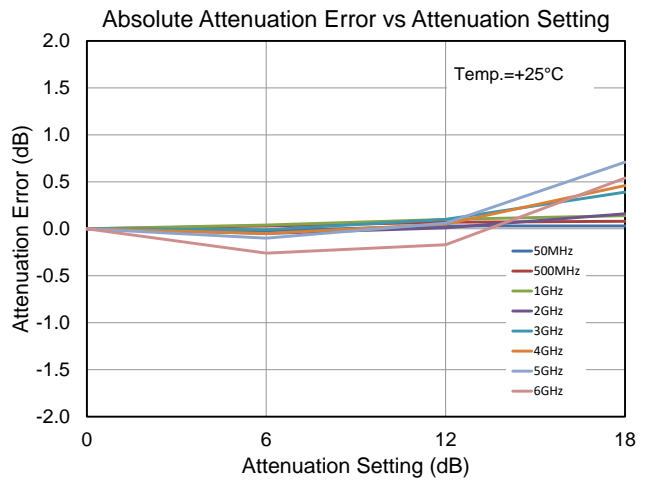
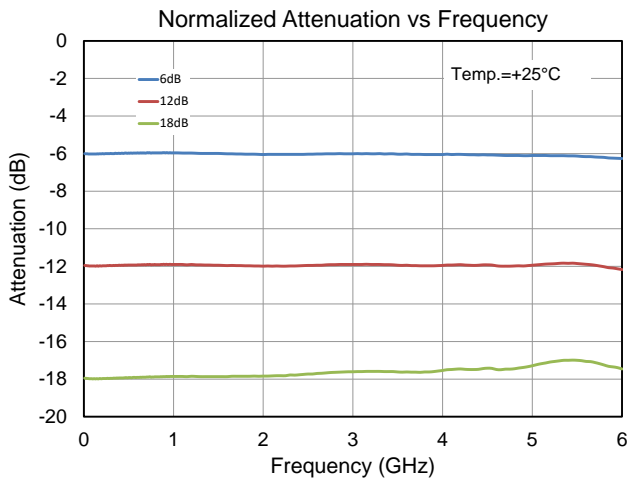
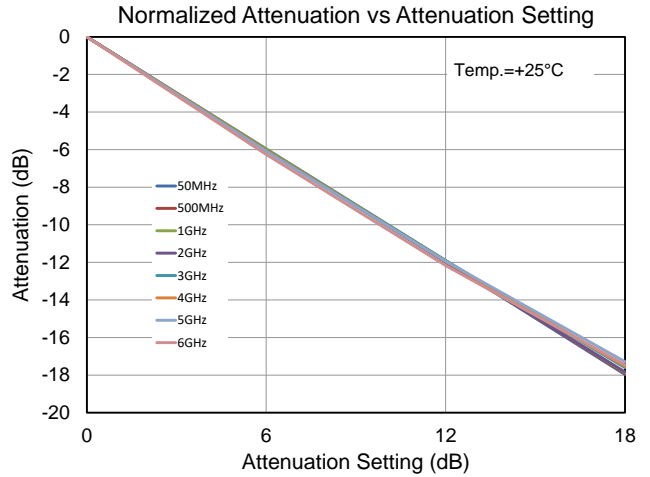
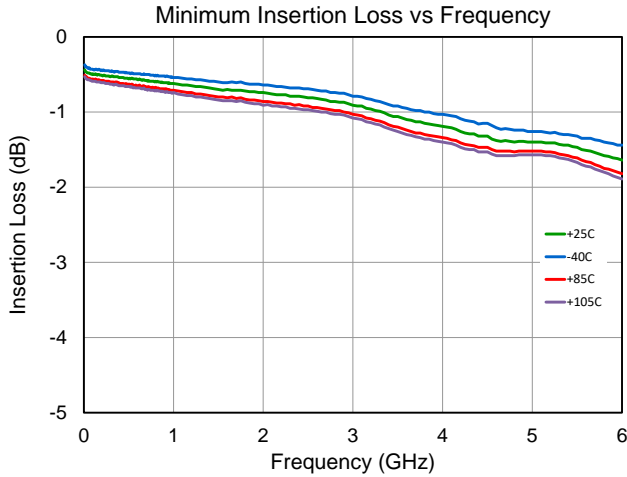

Typical Performance Plots

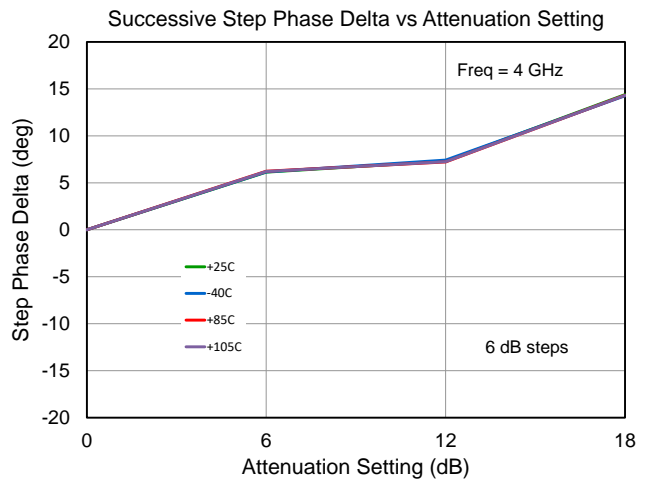
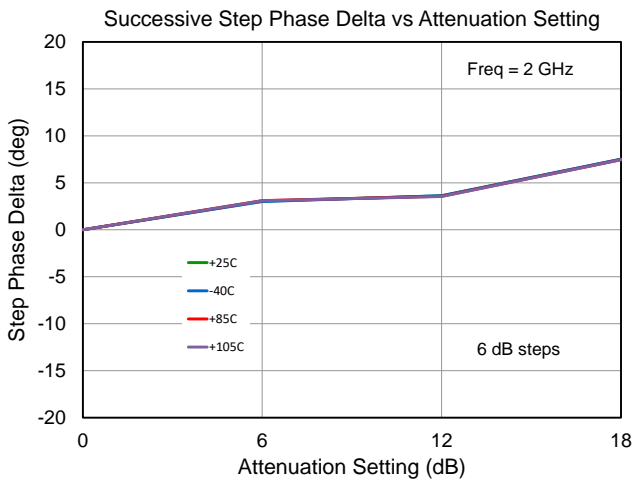
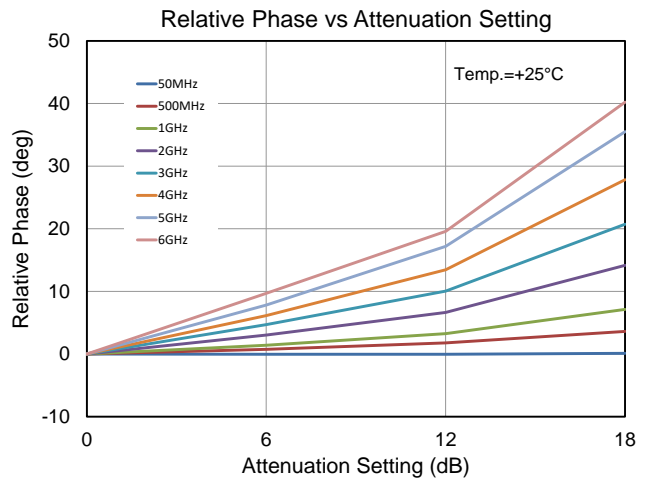
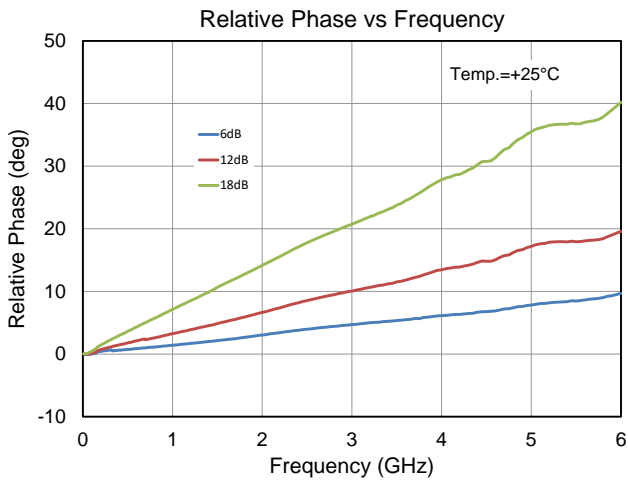
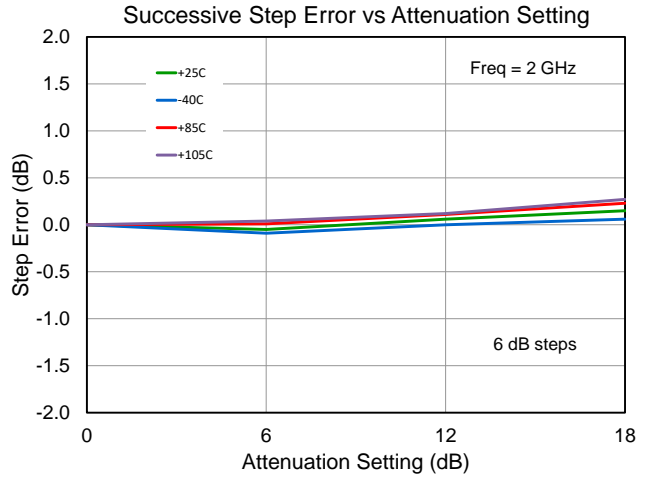
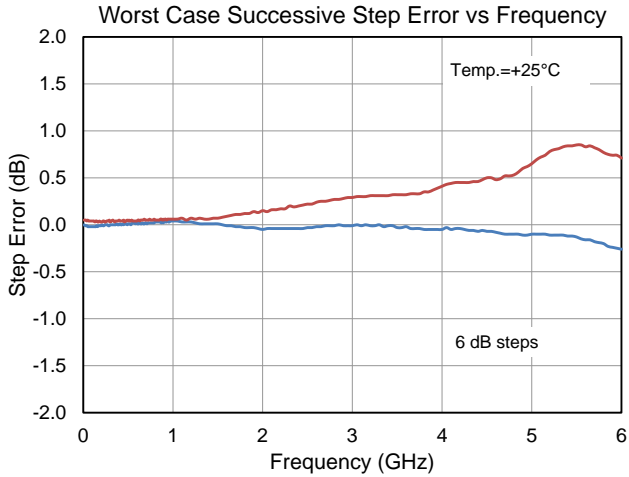

Typical Performance Plots

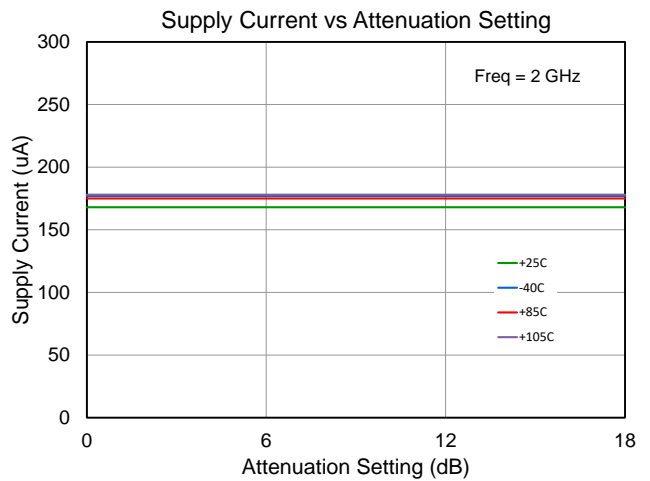
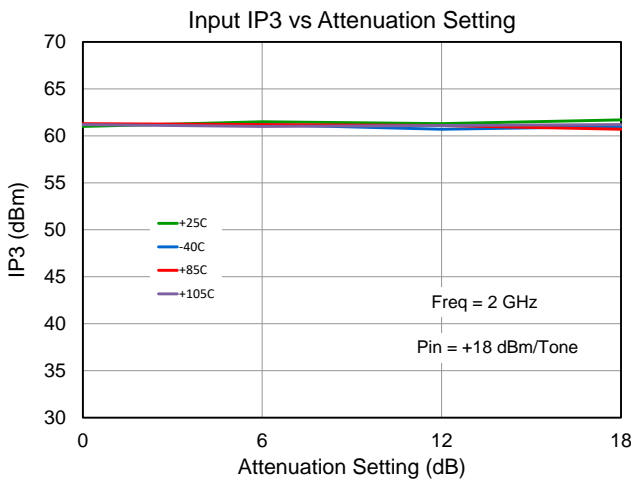
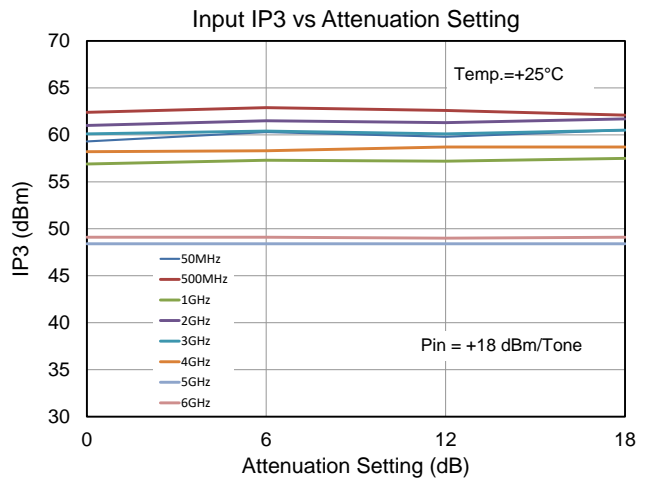
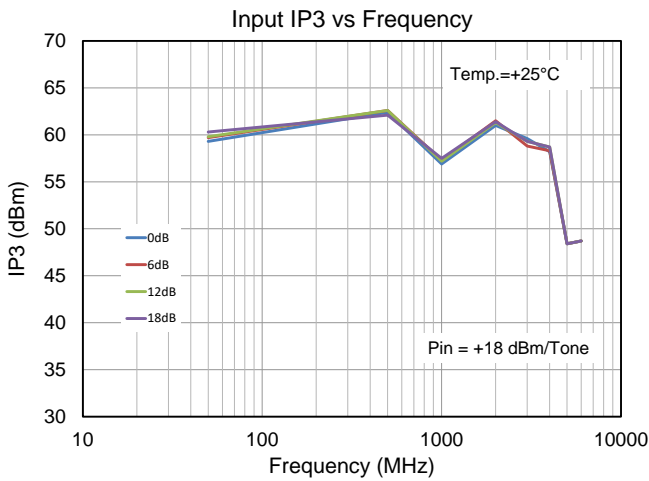
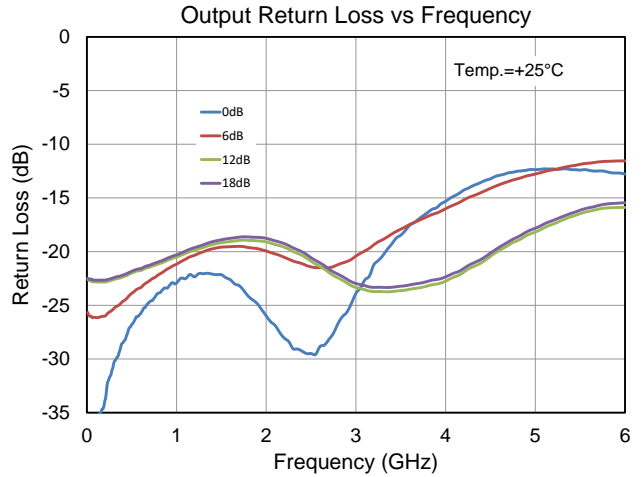
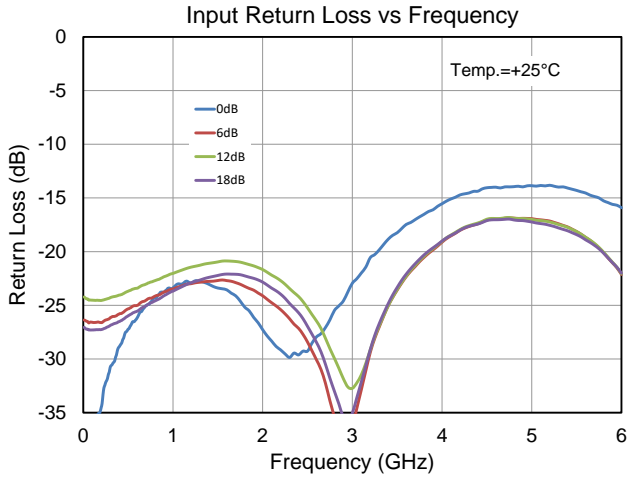

Evaluation Board Assembly Drawing

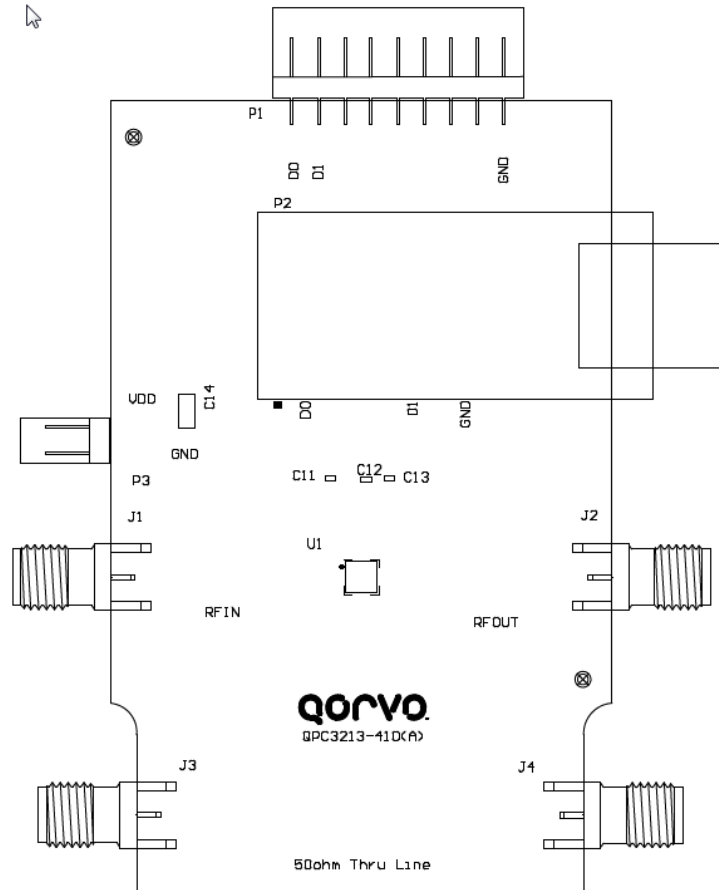

Bill of Material – Evaluation Board

Reference Des.	Value	Description	Manufacturer	Part Number
N/A	N/A	Printed Circuit Board	Qorvo	QPC3213-410(A)
U1	N/A	Digital Step Attenuator, 50MHz to 6000MHz	Qorvo	QPC3223SB
C14	1 μ F	CAP, 1 μ F, 10%, 25V, X7R, 1206	Taiyo Yuden	CE TMK316BJ105KL-T
J1-J4	N/A	CONN, SMA, END LNCH, UNIV, HYB MNT, FLT	Molex	SD-73251-4000
P3	N/A	CONN, HDR, ST, PLRZD, 2-PIN, 0.100"	ITW Pancon	MPSS100-2-C
P2	N/A	CONN, SKT, 24-PIN DIP, 0.600", T/H	Aries Electronics Inc.	24-6518-10
P1	N/A	CONN, HDR, ST, 9-PIN, 0.100", T/H	Samtec Inc.	TSW-109-07-G-S
M1 (See Note)	N/A	MOD, USB TO SERIAL UART, SSOP-28	Future Technology	UM232R
C11	470 pF	CAP, 470pF, 5%, 50V, C0G, 0402	Murata Electronics	GRM1555C1H471JA01D
C12-C13	N/A	DNP	N/A	N/A

Notes:

1. M1 should be mounted into P2 with respect to the Pin 1 alignment of M1 and P2.

Evaluation Board Programming Using USB Interface

Parallel Mode

Refer to the Control Bit Generator (CBG) Software Reference Manual for detailed instructions on how to setup the software for use. Apply the supply voltage to P3. Select 'QPC3223' from the Parts List of the CBG user interface. Set the attenuation value using the CBG user interface. The attenuator is set to the desired state and measurements can be taken.

Evaluation Board Programming Using External Bus

Parallel Mode

This configuration allows the user to control the attenuator through the P1 connector using an external harness. Remove the USB interface if it is currently installed on the evaluation board. Connect a user-supplied harness to the P1 connector. The parallel bus signal names for P1 are indicated on the evaluation board. Cross reference for device pins names to P1 connector signals is as follows: C1 = D0, C2 = D1. Apply the supply voltage to P3. Send the appropriate signals onto the parallel bus lines in accordance with the Parallel Interface Attenuation Truth Table. The attenuator is set to the desired state and measurements can be taken.

Default Power-up State

The default attenuation state is maximum (18dB) when supply voltage is applied to the attenuator. If a different attenuation state is desired during power up, this can be accomplished by applying signals according to the Parallel Interface Attenuation Truth Table. The attenuator will power up to the state applied to the parallel bus during turn on.

Parallel Interface Attenuation Truth

Attenuation Word		Attenuation State
C1 (D0)	C2 (D1)	
L	L	0dB / Reference Insertion Loss
H	L	6 dB
L	H	12 dB
H	H	18 dB

Pad Configuration and Description

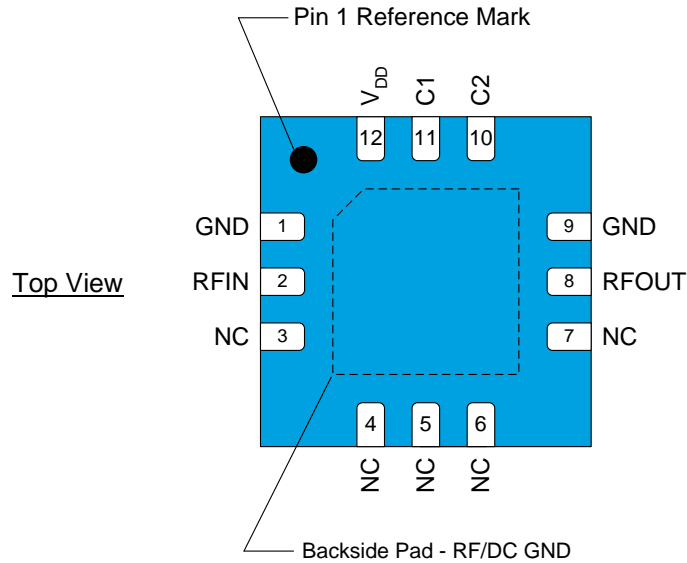

Pad No.	Label	Description
1	GND	Ground Pin; Connect to PCB ground
2	RFIN	RF Input Pin; Incident RF power must enter this pin for rated thermal performance and reliability. Do not apply DC power to this pin. Pin may be DC grounded externally and is grounded thru resistors internal to the part.
3	NC	Open in package. Connect to PCB ground or leave floating
4	NC	Open in package. Connect to PCB ground or leave floating
5	NC	Open in package. Connect to PCB ground or leave floating
6	NC	Open in package. Connect to PCB ground or leave floating
7	NC	Open in package. Connect to PCB ground or leave floating
8	RFOUT	RF Output Pin; Pin may be DC grounded externally and is grounded thru resistors internal to the part.
9	GND	Ground Pin; Connect to PCB ground
10	C2	12dB bit parallel logic input; 1.8V CMOS compatible logic
11	C1	6dB bit parallel logic input; 1.8V CMOS compatible logic
12	V _{DD}	Supply Voltage
Backside Pad	GND	RF/DC ground. Use recommended via pattern to minimize inductance and thermal resistance. See PCB Mounting Pattern for suggested footprint.

Package Dimensions

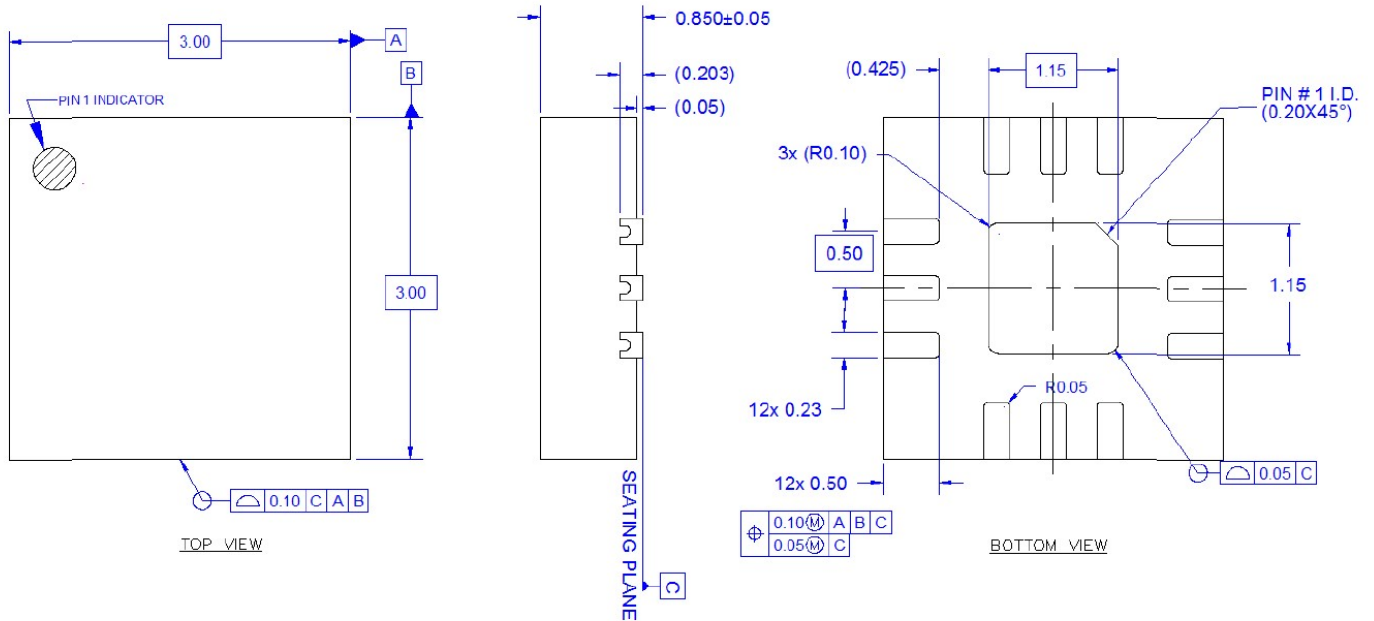

Notes:
1. All Dimensions in millimeters

Branding Diagram

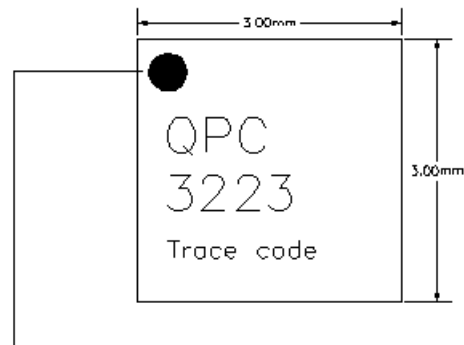

Pin 1 Indicator
Trace code to be assigned by SubCon

Tape and Reel Information – Carrier and Cover Tape Dimensions

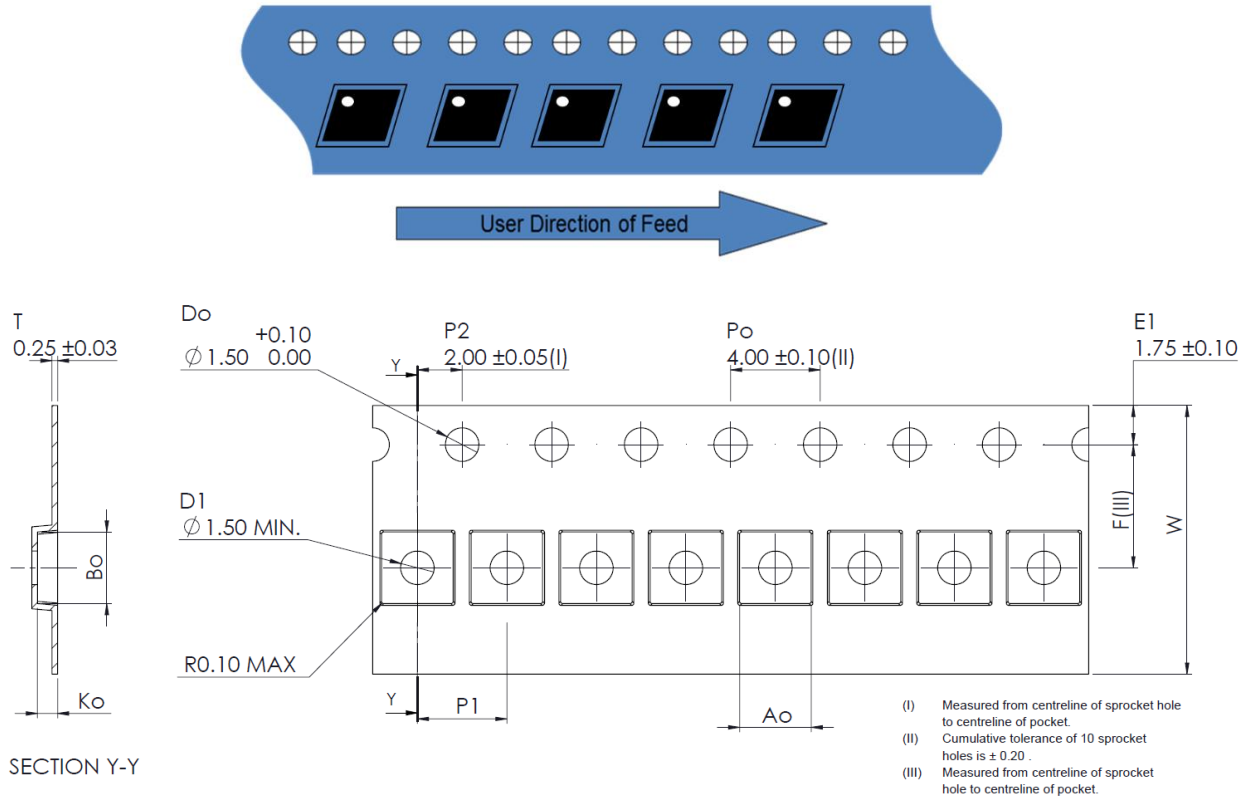

Feature	Measure	Symbol	Size (in)	Size (mm)
Cavity	Length	A0	0.125	3.20
	Width	B0	0.125	3.20
	Depth	K0	0.040	1.00
	Pitch	P1	0.157	4.00
Centerline Distance	Cavity to Perforation - Length Direction	P2	0.079	2.00
	Cavity to Perforation - Width Direction	F	0.217	5.50
Cover Tape	Width	C	0.362	9.20
Carrier Tape	Width	W	0.472	12.0

Tape and Reel Information – Reel Dimensions

Standard T/R size = 2,500 pieces on a 7" reel.

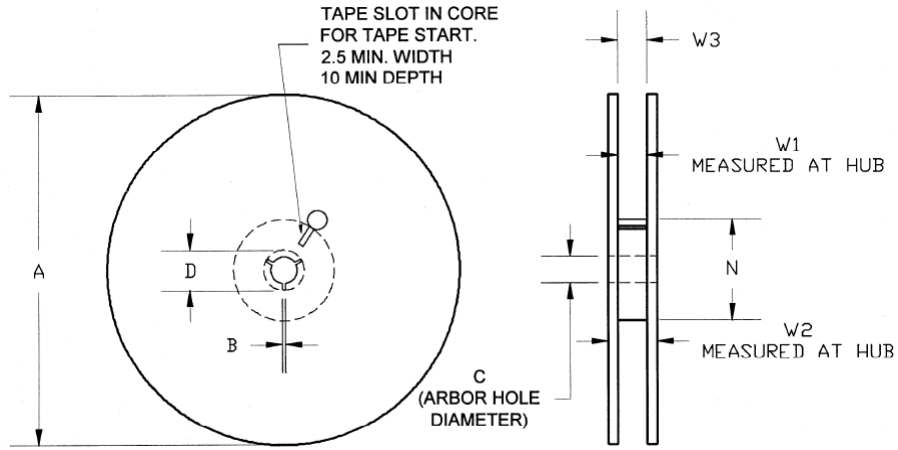

Feature	Measure	Symbol	Size (in)	Size (mm)
Flange	Diameter	A	6.969	177.0
	Thickness	W2	0.717	18.2
	Space Between Flange	W1	0.504	12.8
Hub	Outer Diameter	N	2.283	58.0
	Arbor Hole Diameter	C	0.512	13.0
	Key Slit Width	B	0.079	2.0
	Key Slit Diameter	D	0.787	20.0

Tape and Reel Information – Tape Length and Label Placement

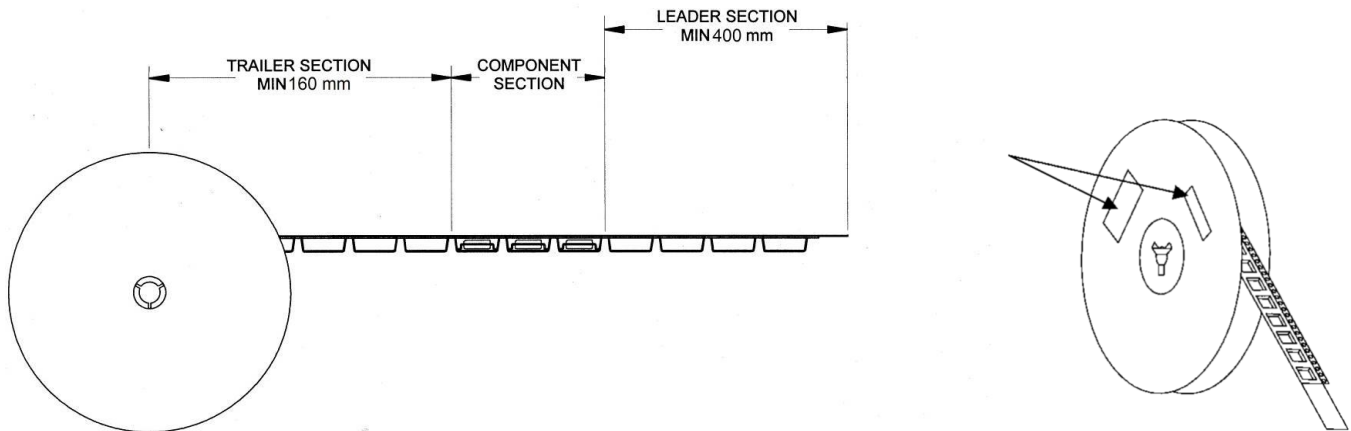

- Notes:
1. Empty part cavities at the trailing and leading ends are sealed with cover tape. See EIA 481-1-A.
 2. Labels are placed on the flange opposite the sprockets in the carrier tape.

Handling Precautions

Parameter	Rating	Standard
ESD – Human Body Model (HBM)	Class 1C	ANSI / ESDA / JEDEC JS-001-2014
ESD – Human Body Model (CDM)	Class C3	ANSI / ESDA / JEDEC JS-002-2014
MSL – Moisture Sensitivity Level	Level 2	IPC / JEDEC J-STD-020



Caution!
ESD-Sensitive Device

Solderability

Compatible with both lead-free (260°C max. reflow temp.) and tin/lead (245°C max. reflow temp.) soldering processes. Solder profiles available upon request.

Contact plating: NiPdAu

RoHS Compliance

This part is compliant with 2011/65/EU RoHS directive (Restrictions on the Use of Certain Hazardous Substances in Electrical and Electronic Equipment) as amended by Directive 2015/863/EU.

This product also has the following attributes:

- Lead Free
- Halogen Free (Chlorine, Bromine)
- Antimony Free
- TBBP-A (C₁₅H₁₂Br₄O₂) Free
- PFOS Free
- SVHC Free



Contact Information

For the latest specifications, additional product information, worldwide sales and distribution locations:

Web: www.qorvo.com

Tel: 1-844-890-8163

Email: customer.support@qorvo.com

Important Notice

The information contained herein is believed to be reliable; however, Qorvo makes no warranties regarding the information contained herein and assumes no responsibility or liability whatsoever for the use of the information contained herein. All information contained herein is subject to change without notice. Customers should obtain and verify the latest relevant information before placing orders for Qorvo products. The information contained herein or any use of such information does not grant, explicitly or implicitly, to any party any patent rights, licenses, or any other intellectual property rights, whether with regard to such information itself or anything described by such information. **THIS INFORMATION DOES NOT CONSTITUTE A WARRANTY WITH RESPECT TO THE PRODUCTS DESCRIBED HEREIN, AND QORVO HEREBY DISCLAIMS ANY AND ALL WARRANTIES WITH RESPECT TO SUCH PRODUCTS WHETHER EXPRESS OR IMPLIED BY LAW, COURSE OF DEALING, COURSE OF PERFORMANCE, USAGE OF TRADE OR OTHERWISE, INCLUDING THE IMPLIED WARRANTIES OF MERCHANTABILITY AND FITNESS FOR A PARTICULAR PURPOSE.**

Without limiting the generality of the foregoing, Qorvo products are not warranted or authorized for use as critical components in medical, life-saving, or life-sustaining applications, or other applications where a failure would reasonably be expected to cause severe personal injury or death.

Copyright 2019 © Qorvo, Inc. | Qorvo is a registered trademark of Qorvo, Inc.

Компания «Океан Электроники» предлагает заключение долгосрочных отношений при поставках импортных электронных компонентов на взаимовыгодных условиях!

Наши преимущества:

- Поставка оригинальных импортных электронных компонентов напрямую с производств Америки, Европы и Азии, а так же с крупнейших складов мира;
- Широкая линейка поставок активных и пассивных импортных электронных компонентов (более 30 млн. наименований);
- Поставка сложных, дефицитных, либо снятых с производства позиций;
- Оперативные сроки поставки под заказ (от 5 рабочих дней);
- Экспресс доставка в любую точку России;
- Помощь Конструкторского Отдела и консультации квалифицированных инженеров;
- Техническая поддержка проекта, помощь в подборе аналогов, поставка прототипов;
- Поставка электронных компонентов под контролем ВП;
- Система менеджмента качества сертифицирована по Международному стандарту ISO 9001;
- При необходимости вся продукция военного и аэрокосмического назначения проходит испытания и сертификацию в лаборатории (по согласованию с заказчиком);
- Поставка специализированных компонентов военного и аэрокосмического уровня качества (Xilinx, Altera, Analog Devices, Intersil, Interpoint, Microsemi, Actel, Aeroflex, Peregrine, VPT, Syfer, Eurofarad, Texas Instruments, MS Kennedy, Miteq, Cobham, E2V, MA-COM, Hittite, Mini-Circuits, General Dynamics и др.);

Компания «Океан Электроники» является официальным дистрибьютором и эксклюзивным представителем в России одного из крупнейших производителей разъемов военного и аэрокосмического назначения «JONHON», а так же официальным дистрибьютором и эксклюзивным представителем в России производителя высокотехнологичных и надежных решений для передачи СВЧ сигналов «FORSTAR».



JONHON

«JONHON» (основан в 1970 г.)

Разъемы специального, военного и аэрокосмического назначения:

(Применяются в военной, авиационной, аэрокосмической, морской, железнодорожной, горно- и нефтедобывающей отраслях промышленности)

«FORSTAR» (основан в 1998 г.)

ВЧ соединители, коаксиальные кабели, кабельные сборки и микроволновые компоненты:

(Применяются в телекоммуникациях гражданского и специального назначения, в средствах связи, РЛС, а так же военной, авиационной и аэрокосмической отраслях промышленности).



Телефон: 8 (812) 309-75-97 (многоканальный)

Факс: 8 (812) 320-03-32

Электронная почта: ocean@oceanchips.ru

Web: <http://oceanchips.ru/>

Адрес: 198099, г. Санкт-Петербург, ул. Калинина, д. 2, корп. 4, лит. А