

### Product Overview

The TQP7M9103 is a high linearity driver amplifier in industry standard, RoHS compliant, SOT-89 surface mount package. This InGaP/GaAs HBT delivers high performance across a broad range of frequencies while achieving +45 dBm OIP3 and +29.5 dBm P1dB while only consuming 235 mA quiescent current. All devices are 100% RF and DC tested.

The TQP7M9103 incorporates on-chip features that differentiate it from other products in the market. The amplifier integrates an on-chip DC over-voltage and RF over-drive protection. This protects the amplifier from electrical DC voltage surges and high input RF input power levels that may occur in a system.

The TQP7M9103 is targeted for use as a driver amplifier in wireless infrastructure where high linearity, medium power, and high efficiency are required. The device an excellent candidate for transceiver line cards and high power amplifiers in current and next generation multi-carrier 3G/4G base stations.



3-pin SOT-89 Package

### Key Features

- 400 – 4000 MHz
- +29.5 dBm P1dB
- +45 dBm Output IP3
- 16.5 dB Gain at 2140 MHz
- +5 V Single Supply, 235 mA Current
- Internal RF Overdrive Protection
- Internal DC Overvoltage Protection
- On chip ESD Protection
- RF Power Handling 10:1 VSWR,  $V_{CC}=+5V$ , 2.14 GHz  
Pout=+29.5 dBm CW  
Pout=+20 dBm WCDMA
- SOT-89 Package

### Functional Block Diagram



Top View

### Applications

- Repeaters
- BTS Transceivers
- BTS High Power Amplifiers
- CDMA / WCDMA / LTE
- General Purpose Wireless

### Ordering Information

| Part No.          | Description                      |
|-------------------|----------------------------------|
| TQP7M9103         | 1 W High Linearity Amplifier     |
| TQP7M9103-PCB900  | 920–960 MHz Evaluation Board     |
| TQP7M9103-PCB2140 | 2.11–2.17 GHz Evaluation Board   |
| TQP7M9103-PCB2600 | 2.62 – 2.69 GHz Evaluation Board |

Standard T/R size = 1000 pieces on a 7" reel

## Absolute Maximum Ratings

| Parameter                          | Rating        |
|------------------------------------|---------------|
| Storage Temperature                | -65 to 150 °C |
| RF Input Power, CW, 50 Ω, T=+25 °C | +30 dBm       |
| Device Voltage (V <sub>CC</sub> )  | +8 V          |

Operation of this device outside the parameter ranges given above may cause permanent damage.

## Recommended Operating Conditions

| Parameter                                      | Min | Typ  | Max   | Units |
|--|-----|------|-------|-------|
| Device Voltage (V <sub>CC</sub> )              |     | +5.0 | +5.25 | V     |
| T <sub>CASE</sub>                              | -40 |      | +105  | °C    |
| T <sub>j</sub> for >10 <sup>6</sup> hours MTTF |     |      | +170  | °C    |

Electrical specifications are measured at specified test conditions. Specifications are not guaranteed over all recommended operating conditions.

## Electrical Specifications

Test conditions unless otherwise noted: V<sub>CC</sub> = +5.0 V, Temp = +25 °C

| Parameter                           | Conditions                                  | Min   | Typ   | Max  | Units |
|-------------------------------------|---|-------|-------|------|-------|
| Operational Frequency Range         |   | 400   |       | 4000 | MHz   |
| Test Frequency                      |   |       | 2140  |      | MHz   |
| Gain                                |   | 14.7  | 16.6  | 17.7 | dB    |
| Input Return Loss                   |   |       | 12.0  |      | dB    |
| Output Return Loss                  |   |       | 15.0  |      | dB    |
| Output P1dB                         |   | +28.5 | +29.5 |      | dBm   |
| Output IP3                          | P <sub>out</sub> = +15 dBm/tone, Δf = 1 MHz | +42.5 | +45   |      | dBm   |
| WCDMA Output Power                  | -50 dBc ACLR <sup>(1)</sup>                 |       | +20   |      | dBm   |
| Noise Figure                        |   |       | 4.4   |      | dB    |
| Quiescent Current, I <sub>CO</sub>  |   | 210   | 235   | 260  | mA    |
| Thermal Resistance, θ <sub>jc</sub> | Module (junction to case)                   |       |       | 35.6 | °C/W  |

Notes:

1. ACLR Test set-up: 3GPP WCDMA, TM1+64 DPCH, +5 MHz offset, PAR = 10.2 dB at 0.01% Prob.

Device Characterization Data

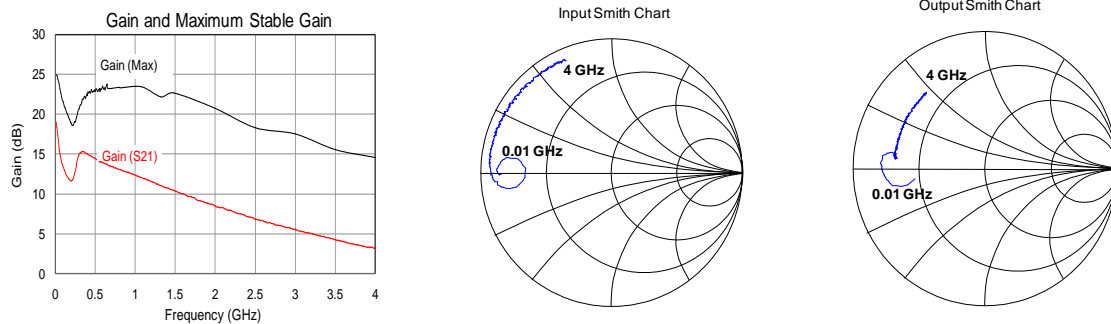

Note: The gain for the unmatched device in 50 ohm system is shown as the trace in red color, [Gain (S21)]. For a tuned circuit for a particular frequency, its expected gain will be higher, up to the maximum stable gain. The maximum stable gain is shown as the black trace, [Gain (Max)]. The impedance plots are shown from 0.01– 4 GHz.

S-Parameters

Test Conditions: V<sub>CC</sub>=+5 V, I<sub>CQ</sub>=235 mA, T=+25°C, unmatched 50 ohm system, calibrated to device leads

| Freq (MHz) | S11 (dB) | S11 (ang) | S21 (dB) | S21 (ang) | S12 (dB) | S12 (ang) | S22 (dB) | S22 (ang) |
|------------|----------|-----------|----------|-----------|----------|-----------|----------|-----------|
| 50         | -1.05    | 179.35    | 15.75    | 154.01    | -35.54   | -2.51     | -2.94    | -171.04   |
| 100        | -1.15    | 176.19    | 13.33    | 155.93    | -35.54   | -9.63     | -2.28    | -176.20   |
| 200        | -2.07    | 171.50    | 11.63    | 168.26    | -37.45   | -27.07    | -2.00    | 176.45    |
| 400        | -1.01    | -176.54   | 15.01    | 153.46    | -36.02   | 22.73     | -3.38    | 172.64    |
| 600        | -0.61    | 173.92    | 13.87    | 137.55    | -35.08   | 6.61      | -3.21    | 171.33    |
| 800        | -0.59    | 169.36    | 13.05    | 125.26    | -34.89   | 0.27      | -3.18    | 168.76    |
| 1000       | -0.62    | 164.62    | 12.35    | 114.05    | -34.56   | -4.24     | -3.13    | 166.33    |
| 1200       | -0.62    | 160.93    | 11.51    | 103.77    | -34.60   | -7.64     | -3.21    | 164.22    |
| 1400       | -0.67    | 156.67    | 10.73    | 94.67     | -34.79   | -12.27    | -3.18    | 162.12    |
| 1600       | -0.64    | 153.26    | 10.00    | 86.25     | -34.75   | -15.00    | -3.21    | 159.50    |
| 1800       | -0.75    | 149.43    | 9.12     | 78.19     | -34.75   | -17.78    | -3.25    | 156.37    |
| 2000       | -0.64    | 145.77    | 8.50     | 70.63     | -34.81   | -20.08    | -3.09    | 154.32    |
| 2200       | -0.62    | 142.62    | 7.90     | 63.72     | -34.51   | -23.77    | -3.24    | 151.96    |
| 2400       | -0.77    | 139.07    | 7.16     | 57.32     | -34.72   | -26.63    | -3.10    | 148.69    |
| 2600       | -0.66    | 135.41    | 6.58     | 51.13     | -34.60   | -29.04    | -3.07    | 147.12    |
| 2800       | -0.73    | 132.81    | 6.04     | 45.43     | -34.65   | -33.24    | -3.16    | 144.43    |
| 3000       | -0.69    | 128.99    | 5.51     | 39.41     | -34.51   | -33.49    | -3.09    | 141.32    |
| 3200       | -0.74    | 125.72    | 5.01     | 33.18     | -34.65   | -34.26    | -3.12    | 138.96    |
| 3400       | -0.74    | 122.13    | 4.52     | 27.44     | -34.60   | -37.56    | -3.09    | 136.12    |
| 3600       | -0.72    | 119.18    | 4.02     | 22.42     | -34.56   | -43.68    | -3.13    | 133.54    |
| 3800       | -0.77    | 116.00    | 3.52     | 16.74     | -34.37   | -44.96    | -3.04    | 130.91    |
| 4000       | -0.80    | 113.01    | 3.15     | 11.74     | -34.33   | -46.26    | -2.96    | 128.69    |

**Evaluation Board, 615 – 655 MHz Reference Design**

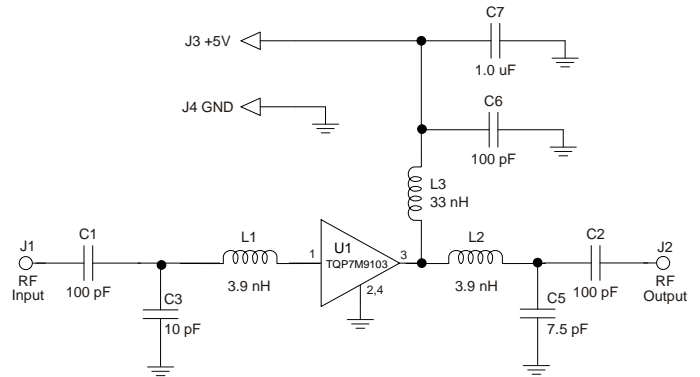
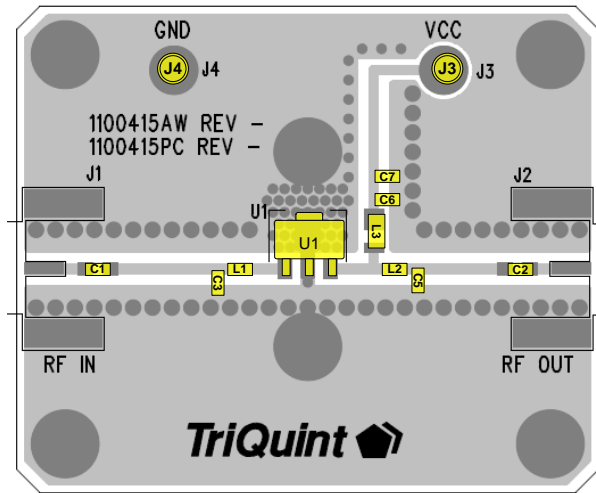

**Notes:**

1. Components shown on the silkscreen but not on the schematic are not used.
2. 0 Ω resistor can be replaced with copper trace in the target application layout.
3. All components are of 0603 size unless stated on the schematic.
4. The recommended component values are dependent upon the frequency of operation.
5. Critical component placement locations:
  - Distance between U1 Pin 1 Pad left edge to L1 (right edge): 55 mil
  - Distance between U1 Pin 1 Pad left edge to C3 (right edge): 130 mil
  - Distance between U1 Pin 3 Pad right edge to C5 (left edge): 160 mil
  - Distance between U1 Pin 3 Pad right edge to L2 (left edge): 85 mil

**Bill of Material, 615 – 655 MHz**

| Reference Des. | Value  | Description                    | Manuf.    | Part Number    |
|----------------|--------|--------------------------------|-----------|----------------|
| n/a            | n/a    | Printed Circuit Board          | Qorvo     |                |
| U1             | n/a    | 1 W High Linearity Amplifier   | Qorvo     | TQP7M9103      |
| C3             | 10 pF  | CAP, 0603, ± 0.05 pF, 50V, NPO | AVX       | 06032U100J     |
| C5             | 7.5 pF | CAP, 0603, ± 0.05 pF, 50V, NPO | AVX       | 06032U7R5B     |
| C1, C2, C6     | 100 pF | CAP, 0603, 5%, 50V, NPO/COG    | various   |                |
| C7             | 1.0 uF | CAP, 0603, 10%, X5R, 10V       | various   |                |
| L1, L2         | 3.9 nH | IND, 0603, +/-0.3nH            | TOKO      | LL1608-FSL3N9S |
| L3             | 33 nH  | IND, 0805, 5%, Wirewound       | Coilcraft | 0805CS-330XJL  |

## Typical Performance, 615 – 655 MHz

Test conditions unless otherwise noted:  $V_{CC} = +5\text{ V}$ ,  $I_{CQ} = 235\text{ mA}$ ,  $Temp. = +25\text{ }^\circ\text{C}$

| Parameter                          | Conditions   | Typical Value |       |       | Units |
|------------------------------------|--|---------------|-------|-------|-------|
| Frequency                          |  | 617           | 635   | 652   | MHz   |
| Gain                               |  | 20.9          | 20.9  | 20.8  | dB    |
| Input Return Loss                  |  | 9.5           | 10    | 10    | dB    |
| Output Return Loss                 |  | 20            | 19    | 18    | dB    |
| Output P1dB                        |  | +29.3         | +29.5 | +29.7 | dBm   |
| OIP3                               | $P_{out} = +19\text{ dBm}$ / tone, $\Delta f = 1\text{ MHz}$ | +47.7         | +46.2 | +44.2 | dBm   |
| WCDMA Channel Power <sup>(1)</sup> | ACLR = -50 dBc   | +19.3         | +19.2 | +18.3 | dBm   |

Notes:

- 1C 20MHz LTE signal, PAR=9.5dB

## Performance Plots, 615 – 655 MHz

Test conditions unless otherwise noted:  $V_{CC} = +5\text{ V}$ ,  $I_{CQ} = 235\text{ mA}$ ,  $Temp. = +25\text{ }^\circ\text{C}$

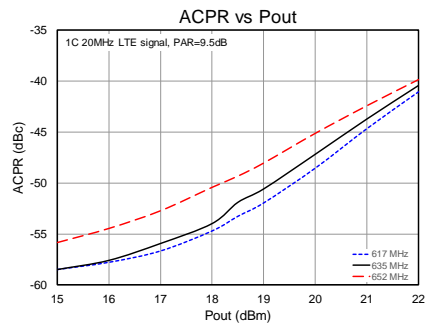
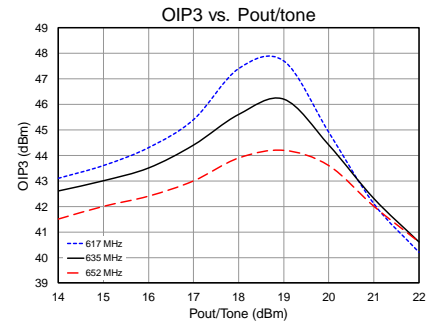
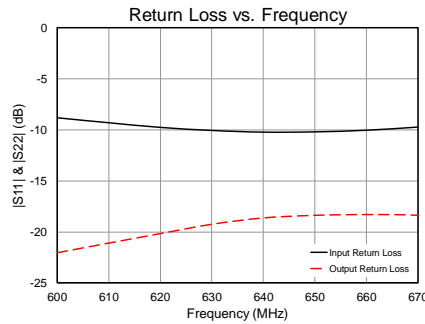
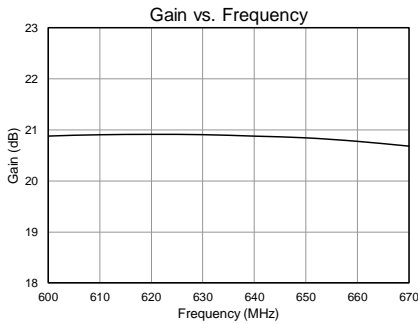

## Evaluation Board, 758 – 875 MHz Reference Design

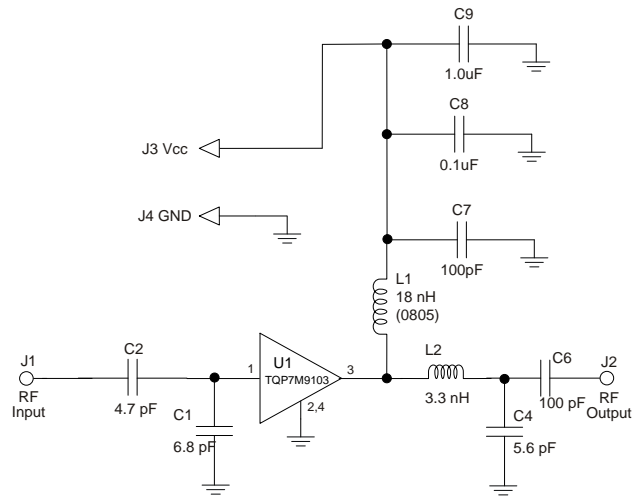
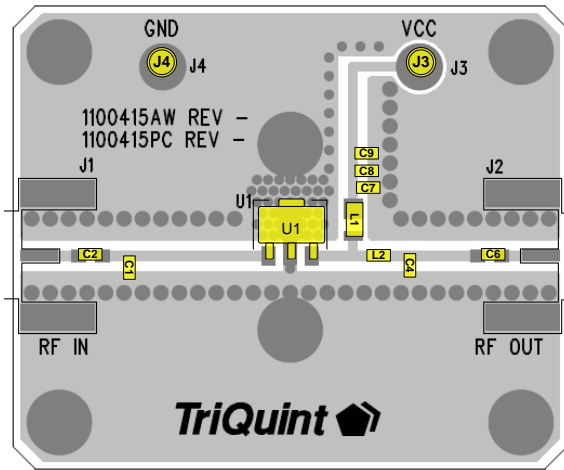

**Notes:**

6. Components shown on the silkscreen but not on the schematic are not used.
7. 0 Ω resistor can be replaced with copper trace in the target application layout.
8. All components are of 0603 size unless stated on the schematic.
9. The recommended component values are dependent upon the frequency of operation.
10. Critical component placement locations:
  - Distance between U1 Pin 1 Pad left edge to C1 (right edge): 362 mil
  - Distance between U1 Pin 3 Pad right edge to L2 (left edge): 150 mil
  - Distance between U1 Pin 3 Pad right edge to C4 (left edge): 230 mil

## Bill of Material, 758 – 875 MHz

| Reference Des. | Value  | Description                    | Manuf.    | Part Number    |
|----------------|--------|--------------------------------|-----------|----------------|
| n/a            | n/a    | Printed Circuit Board          | Qorvo     |                |
| U1             | n/a    | 1 W High Linearity Amplifier   | Qorvo     | TQP7M9103      |
| C1             | 6.8 pF | CAP, 0603, ± 0.05 pF, 50V, NPO | AVX       | 06032U6R8BAT2A |
| C2             | 4.7 pF | CAP, 0603, ± 0.05 pF, 50V, NPO | AVX       | 06032U4R7BAT2A |
| C6, C7         | 100 pF | CAP, 0603, 5%, 50V, NPO/COG    | various   |                |
| C9             | 1.0 uF | CAP, 0603, 10%, X5R , 10V      | various   |                |
| C4             | 5.6 pF | CAP, 0603, ± 0.05 pF, 50V, NPO | AVX       | 06032U5R6BAT2A |
| C8             | 0.1 uF | CAP, chip, 0603                | Various   |                |
| L2             | 3.3 nH | IND, 0805, 5%, Ceramic         | TOKO      | LL1608-FSL3N3S |
| L1             | 18 nH  | IND, 0805, 5%, Wirewound       | Coilcraft | 0805CS-180XJL  |

## Typical Performance, 758 – 875 MHz

Test conditions unless otherwise noted:  $V_{CC} = +5\text{ V}$ ,  $I_{CQ} = 235\text{ mA}$ ,  $Temp. = +25\text{ }^\circ\text{C}$

| Parameter                          | Conditions   | Typical Value |       |       | Units |
|------------------------------------|--|---------------|-------|-------|-------|
| Frequency                          |  | 758           | 803   | 875   | MHz   |
| Gain                               |  | 21            | 21.5  | 21.3  | dB    |
| Input Return Loss                  |  | 7.7           | 11.7  | 11.5  | dB    |
| Output Return Loss                 |  | 16.5          | 17    | 30    | dB    |
| Output P1dB                        |  | +29.2         | +29.5 | +29   | dBm   |
| OIP3                               | $P_{out} = +19\text{ dBm}$ / tone, $\Delta f = 1\text{ MHz}$ | +46.5         | +43.7 | +41.7 | dBm   |
| WCDMA Channel Power <sup>(1)</sup> | ACLR = -50 dBc   | +19.5         | +19.8 | +19.2 | dBm   |

Notes:

- 3GPP WCDMA, TM1+64 DPCH, +5 MHz offset, PAR = 10.2 dB at 0.01% Prob.

## Performance Plots, 758 – 875 MHz

Test conditions unless otherwise noted:  $V_{CC} = +5\text{ V}$ ,  $I_{CQ} = 235\text{ mA}$ ,  $Temp. = +25\text{ }^\circ\text{C}$

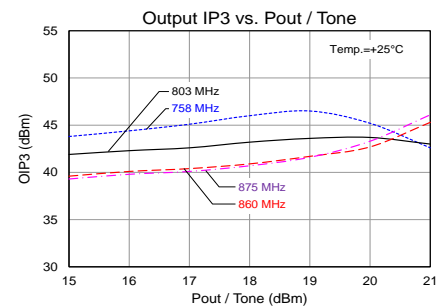
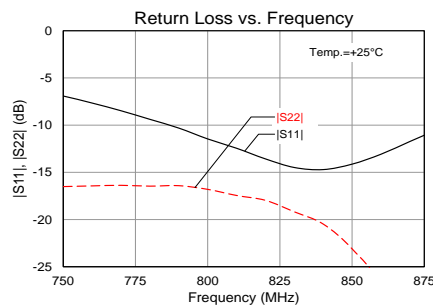
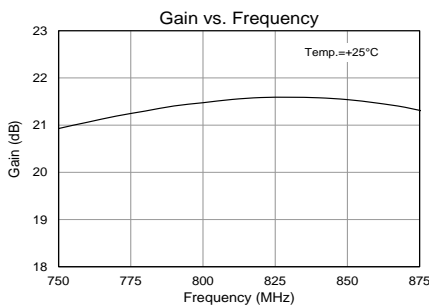

## Typical Performance, 869 – 894 MHz

Test conditions unless otherwise noted:  $V_{CC} = +5\text{ V}$ ,  $I_{CQ} = 235\text{ mA}$ ,  $Temp. = +25\text{ }^\circ\text{C}$

| Parameter                          | Conditions  | Typical Value |       |       | Units |
|------------------------------------|---|---------------|-------|-------|-------|
| Frequency                          |   | 869           | 880   | 894   | MHz   |
| Gain                               |   | 20.8          | 20.8  | 20.8  | dB    |
| Input Return Loss                  |   | 17.5          | 18.7  | 17.2  | dB    |
| Output Return Loss                 |   | 14.3          | 14.4  | 14.5  | dB    |
| Output P1dB                        |   | +29.2         | +29.3 | +29.4 | dBm   |
| OIP3                               | $P_{out} = +19\text{ dBm / tone}$ , $\Delta f = 1\text{ MHz}$ | +43.6         | +42.9 | +42.3 | dBm   |
| WCDMA Channel Power <sup>(1)</sup> | ACLR = -50 dBc  | +19.7         | +19.7 | +19.7 | dBm   |

Notes:

- 3GPP WCDMA, TM1+64 DPCH, +5 MHz offset, PAR = 10.2 dB at 0.01% Prob.

## RF Performance Plots, 869 – 894 MHz

Test conditions unless otherwise noted:  $V_{CC} = +5\text{ V}$ ,  $I_{CQ} = 235\text{ mA}$ ,  $Temp. = +25\text{ }^\circ\text{C}$

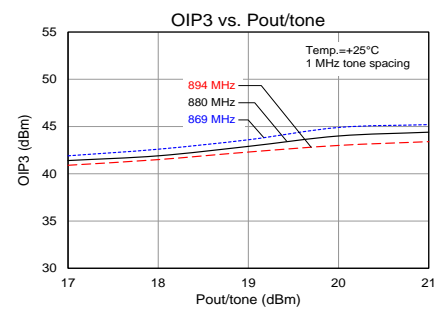
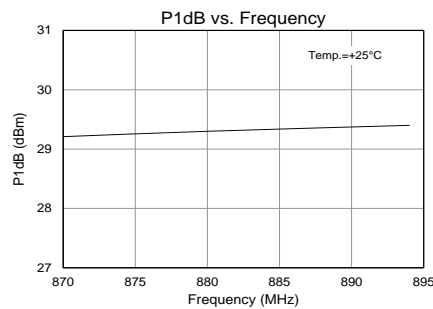
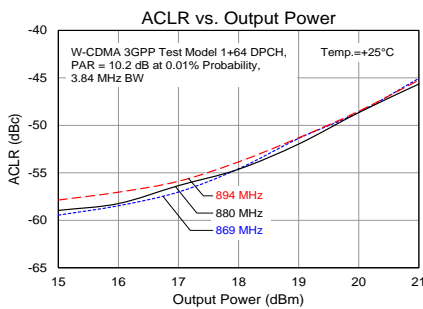
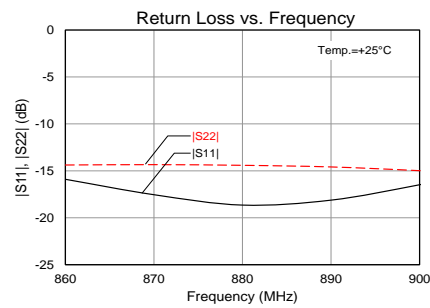
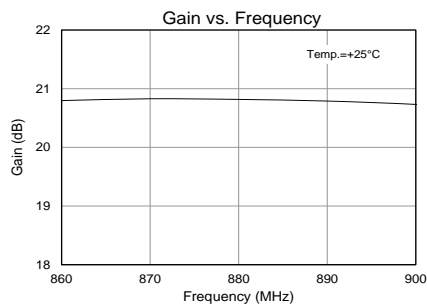



**Evaluation Board, TQP7M9103-PCB900**



**Notes:**

11. All components are of 0603 size unless stated on the schematic.
12. The recommended component values are dependent upon the frequency of operation.
13. Critical component placement locations:
  - Distance between U1 Pin 1 Pad to C4 (right edge): 20 mil
  - Distance between U1 Pin 1 Pad to C3 (right edge): 130 mil
  - Distance between U1 Pin 3 Pad to C5 (left edge): 158 mil
  - Distance between U1 Pin 3 Pad to L2 (left edge): 85 mil

**Bill of Material, TQP7M9103-PCB900**

| Reference Des. | Value  | Description                    | Manuf.    | Part Number    |
|----------------|--------|--------------------------------|-----------|----------------|
| U1             | n/a    | 1 W High Linearity Amplifier   | Qorvo     | TQP7M9103      |
| C3, C5         | 4.7 pF | CAP, 0603, ± 0.05 pF, 50V, NPO | AVX       | 06032U4R7BAT2A |
| C4             | 10 pF  | CAP, 0603, ± 0.05 pF, 50V, NPO | AVX       | 06035A100JAT2A |
| C1, C2, C6     | 100 pF | CAP, 0603, 5%, 50V, NPO/COG    | various   |                |
| C7             | 1.0 uF | CAP, 0603, 10%, X5R, 10V       | various   |                |
| L1             | 3.3 nH | IND, 0603, +/-0.3nH            | TOKO      | LL1608-FSL3N3S |
| L2             | 2.7 nH | IND, 0603, +/-0.3nH            | TOKO      | LL1608-FSL2N7S |
| L3             | 33 nH  | IND, 0805, 5%, Wirewound       | Coilcraft | 0805CS-330XJL  |

## Typical Performance, TQP7M9103-PCB900

Test conditions unless otherwise noted:  $V_{CC} = +5\text{ V}$ ,  $I_{CQ} = 235\text{ mA}$ , Temp. =  $+25\text{ }^\circ\text{C}$

| Parameter                          | Conditions                                       | Typical Value |       |       | Units |
|------------------------------------|--|---------------|-------|-------|-------|
| Frequency                          |  | 920           | 940   | 960   | MHz   |
| Gain                               |  | 20.6          | 20.6  | 20.5  | dB    |
| Input Return Loss                  |  | 12            | 12    | 11.8  | dB    |
| Output Return Loss                 |  | 18            | 18.5  | 19.5  | dB    |
| Output P1dB                        |  | +29.8         | +29.9 | 30    | dBm   |
| OIP3                               | Pout = +19 dBm / tone, $\Delta f = 1\text{ MHz}$ | +46.5         | +44.8 | +44   | dBm   |
| WCDMA Channel Power <sup>(1)</sup> | ACLR = -50 dBc                                   | +20.2         | +20.2 | +20.2 | dBm   |

Notes:

- 3GPP WCDMA, TM1+64 DPCH, +5 MHz offset, PAR = 10.2 dB at 0.01% Prob.

## Performance Plots, TQP7M9103-PCB900

Test conditions unless otherwise noted:  $V_{CC} = +5\text{ V}$ ,  $I_{CQ} = 235\text{ mA}$ , Temp. =  $+25\text{ }^\circ\text{C}$

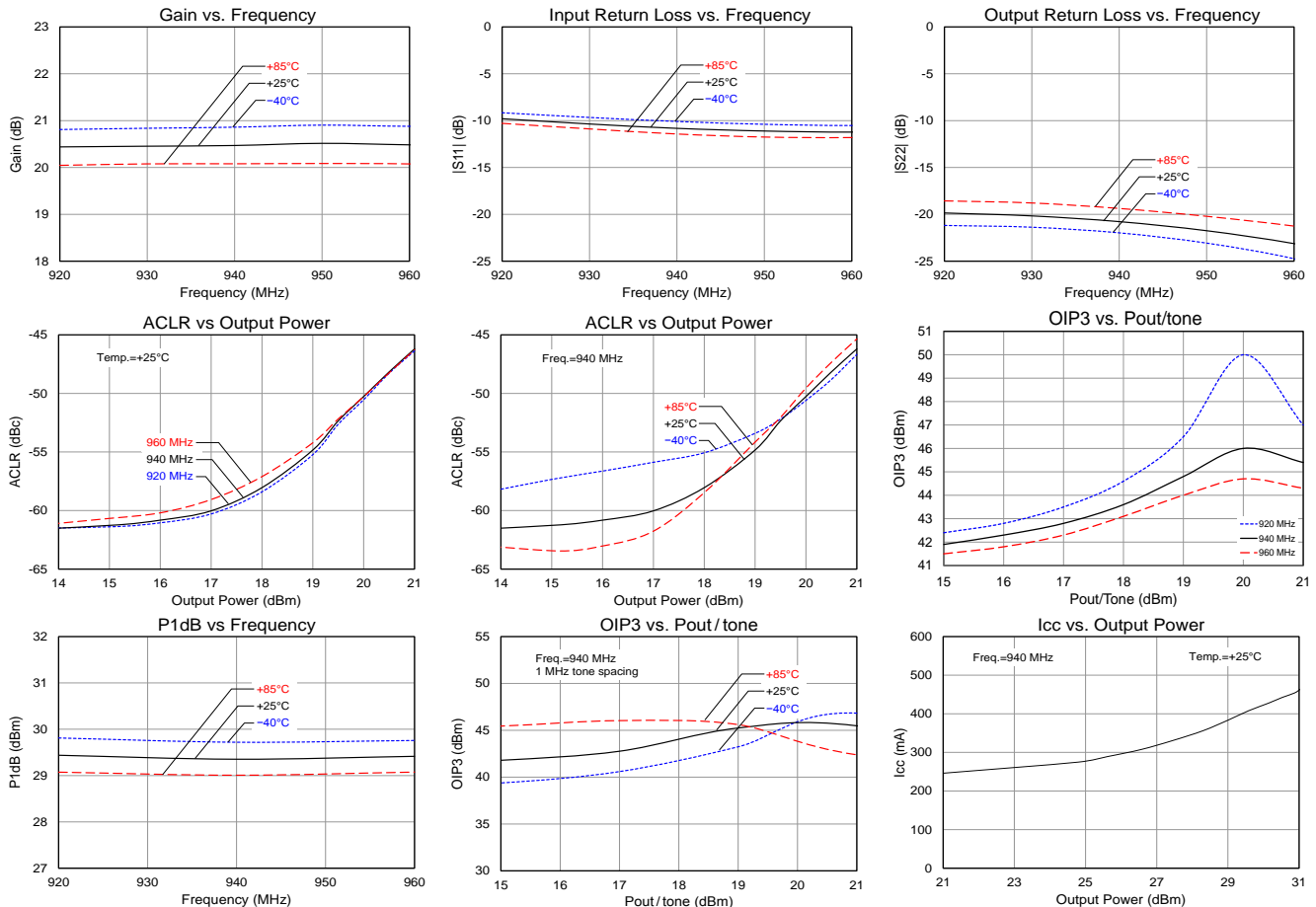

**Evaluation Board, 1805-1880 MHz Reference Design**

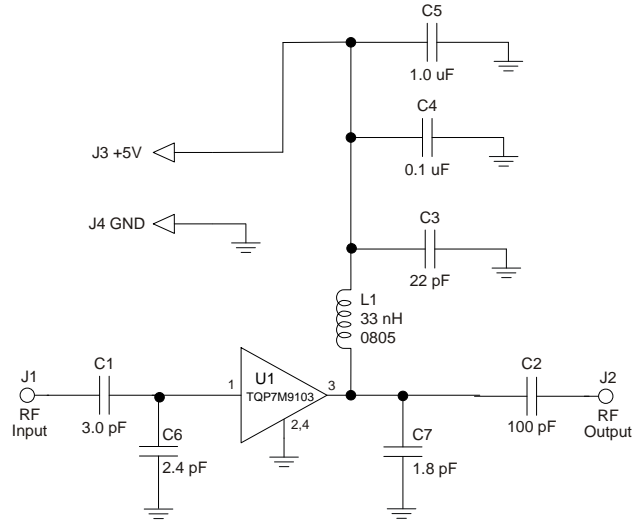
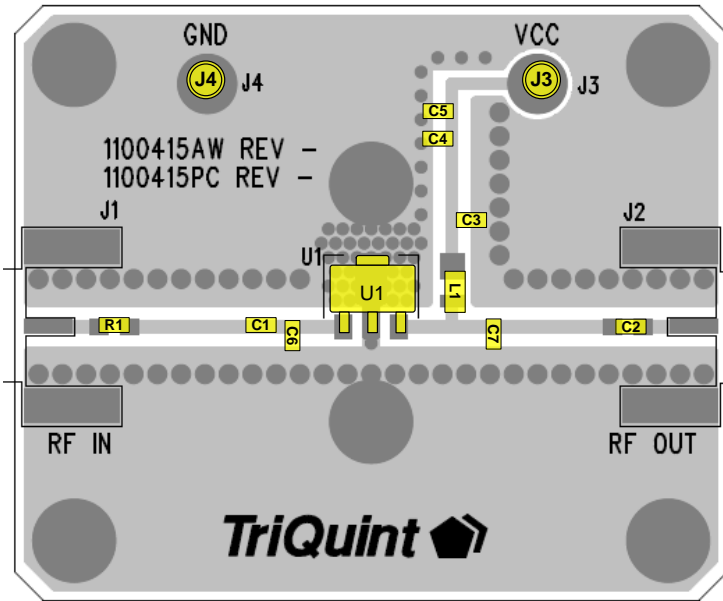

**Notes:**

1. All components are of 0603 size unless stated on the schematic.
2. Distance from right edge of C6 to left edge of device pin 1 pad is 65mil
3. Distance from right edge of C1 to left edge of device pin 1 pad is 110mil
4. Distance from left edge of C7 to right edge of device pin 3 pad is 210mil

**Bill of Material, 1805 – 1880 MHz**

| Reference Des. | Value  | Description                             | Manuf.    | Part Number    |
|----------------|--------|---|-----------|----------------|
| n/a            | n/a    | Printed Circuit Board                   | Qorvo     |                |
| U1             | n/a    | TQP7M9103 Amplifier, SOT-89 pkg.        | Qorvo     |                |
| C1             | 3.0 pF | Cap., Chip, 0603, +/-0.1pF, 200V        | AVX       | 06032U3R0BAT2A |
| C6             | 2.4 pF | Cap., Chip, 0603, +/-0.1pF, 200V        | AVX       | 06032U2R4BAT2A |
| C7             | 1.8 pF | Cap., Chip, 0603, +/-0.1pF, 200V        | AVX       | 06032U1R8BAT2A |
| C2             | 100 pF | Cap., Chip, 0603                        | various   |                |
| C3             | 22 pF  | Cap., Chip, 0603                        | various   |                |
| C4             | 0.1 uF | Cap., Chip, 0603, 10%, 16V, X7R         | various   |                |
| C5             | 1 uF   | Cap., Chip, 0603, 10%, 10V, X5R         | various   |                |
| L1             | 33 nH  | Inductor, 0805, 5%, Coilcraft HP Series | Coilcraft |                |
| R1             | 0 Ω    | Res, chip, 0603                         | various   |                |

## Typical Performance, 1805 – 1880 MHz

Test conditions unless otherwise noted:  $V_{CC} = +5\text{ V}$ ,  $I_{CQ} = 235\text{ mA}$ ,  $Temp. = +25\text{ }^\circ\text{C}$

| Parameter                          | Conditions                                       | Typical Value |       |       | Units |
|------------------------------------|--|---------------|-------|-------|-------|
| Frequency                          |  | 1805          | 1850  | 1880  | MHz   |
| Gain                               |  | 17.7          | 17.7  | 17.7  | dB    |
| Input Return Loss                  |  | 11.6          | 12.3  | 12.1  | dB    |
| Output Return Loss                 |  | 16.1          | 16.3  | 16.6  | dB    |
| Output P1dB                        |  | +29.5         | +29.6 | +29.5 | dBm   |
| OIP3                               | Pout = +16 dBm / tone, $\Delta f = 1\text{ MHz}$ | +44.1         | +43.8 | +43.2 | dBm   |
| WCDMA Channel Power <sup>(1)</sup> | ACLR = -50 dBc                                   | +20.0         | +20.2 | +20.2 | dBm   |

Notes:

- 3GPP WCDMA, TM1+64 DPCH, +5 MHz offset, PAR = 10.2 dB at 0.01% Prob.

## RF Performance Plots, 1805 – 1880 MHz

Test conditions unless otherwise noted:  $V_{CC} = +5\text{ V}$ ,  $I_{CQ} = 235\text{ mA}$ ,  $Temp. = +25\text{ }^\circ\text{C}$

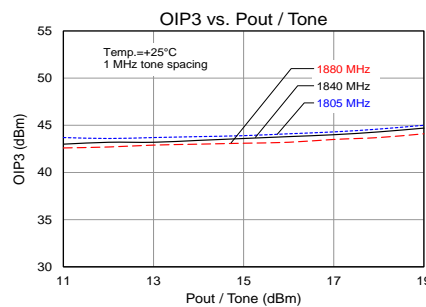
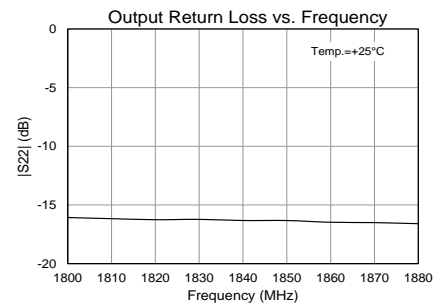
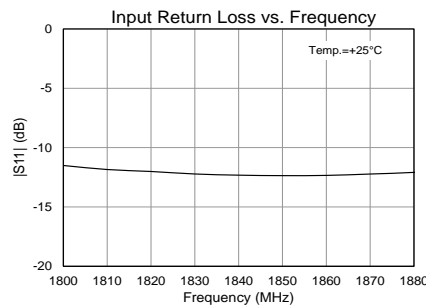

## Typical Performance, 1930 – 1990 MHz

Test conditions unless otherwise noted:  $V_{CC} = +5\text{ V}$ ,  $I_{CQ} = 235\text{ mA}$ ,  $Temp. = +25\text{ }^{\circ}\text{C}$

| Parameter                          | Conditions  | Typical Value |       |       | Units |
|------------------------------------|---|---------------|-------|-------|-------|
| Frequency                          |   | 1930          | 1960  | 1990  | MHz   |
| Gain                               |   | 17.0          | 17.0  | 16.9  | dB    |
| Input Return Loss                  |   | 15.2          | 17.8  | 18.3  | dB    |
| Output Return Loss                 |   | 13.0          | 12.9  | 12.8  | dB    |
| Output P1dB                        |   | +29.3         | +29.3 | +29.3 | dBm   |
| OIP3                               | $P_{out} = +16\text{ dBm} / \text{tone}, \Delta f = 1\text{ MHz}$ | +44.0         | +45.2 | +44.2 | dBm   |
| WCDMA Channel Power <sup>(1)</sup> | ACLR = -50 dBc  | +20.0         | +20.0 | +20.0 | dBm   |

Notes:

- 3GPP WCDMA, TM1+64 DPCH, +5 MHz offset, PAR = 10.2 dB at 0.01% Prob.

## RF Performance Plots, 1930 – 1990 MHz

Test conditions unless otherwise noted:  $V_{CC} = +5\text{ V}$ ,  $I_{CQ} = 235\text{ mA}$ ,  $Temp. = +25\text{ }^{\circ}\text{C}$

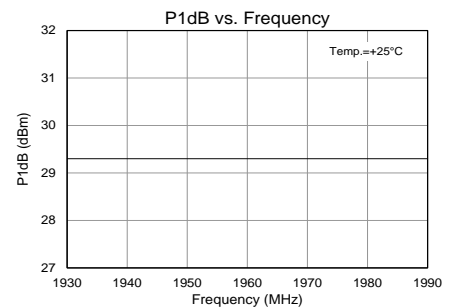
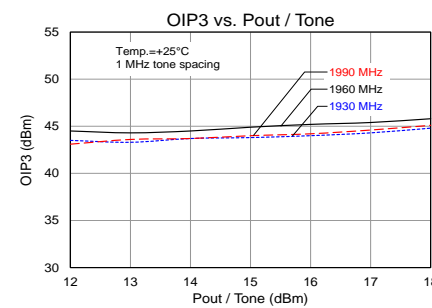
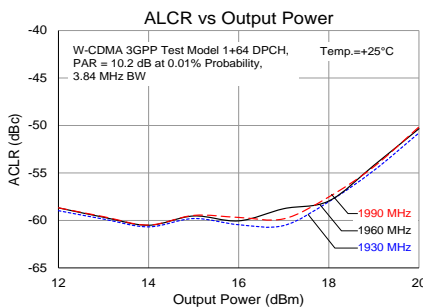
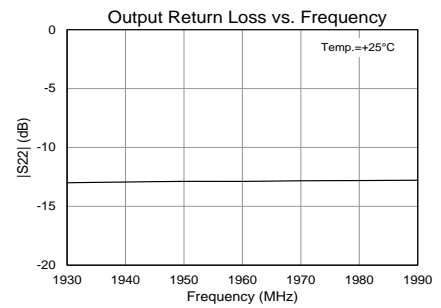
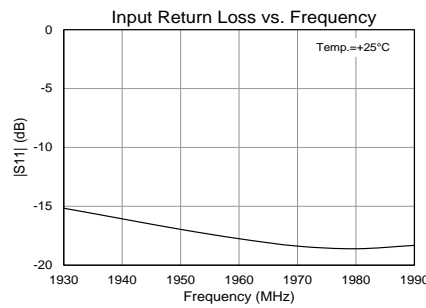
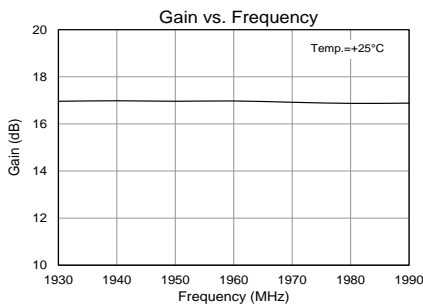

**TQP7M9103-PCB2140 Evaluation Board**

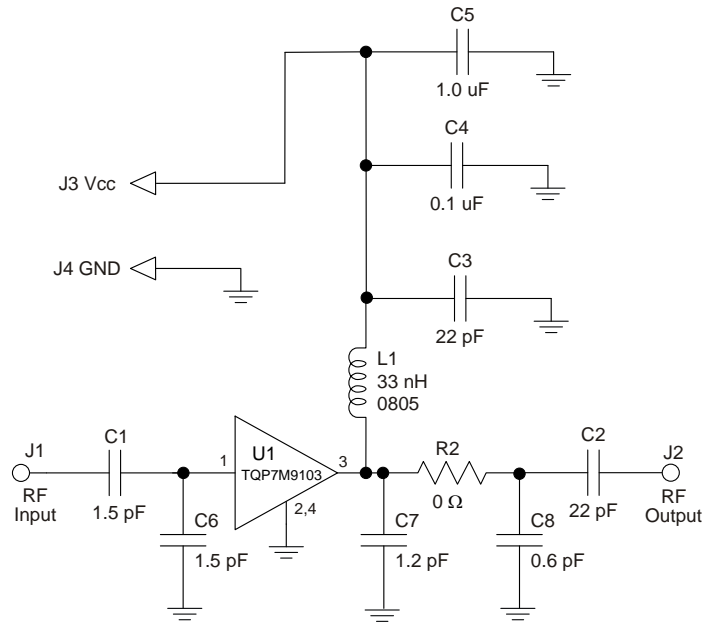
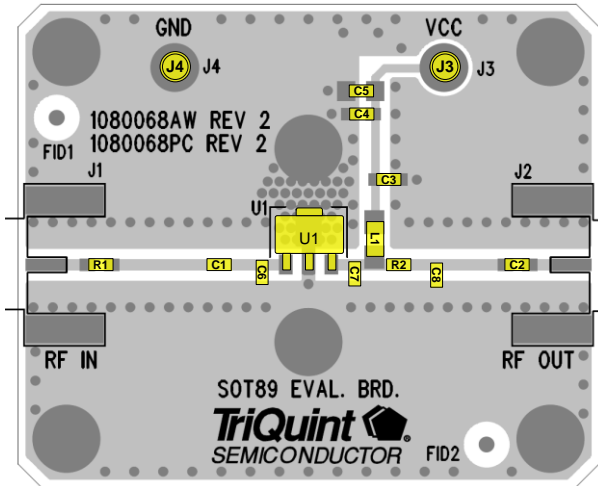

**Notes:**

1. See PC Board Layout, page 11 for more information.
2. Components shown on the silkscreen but not on the schematic are not used.
3. Component (R1) is a 0 Ω resistors may be replaced with copper trace in the target application layout.
4. The recommended component values are dependent upon the frequency of operation.
5. All components are of 0603 size unless stated on the schematic.
6. Critical component placement locations:  
 Distance from U1 Pin 1 Pad (left edge) to C6 (right edge): 28 Mils (3.0° at 2140 MHz)  
 Distance from C6 (left edge) to C1 (right edge): 65 Mils (7.0° at 2140 MHz)  
 Distance from U1 Pin 3 Pad (right edge) to C7 (left edge): 31 Mils (3.4° at 2140 MHz)  
 Distance from C7 (right edge) to R2 (left edge): 60 Mils (6.5° at 2140 MHz)  
 Distance from R2 (right edge) to C8 (left edge): 62 Mils (6.7° at 2140 MHz)

**Bill of Material, TQP7M9103-PCB2140**

| Reference Des. | Value  | Description                              | Manuf.    | Part Number    |
|----------------|--------|--|-----------|----------------|
| n/a            | n/a    | Printed Circuit Board                    | Qorvo     | 1080068        |
| U1             | n/a    | TQP7M9103 Amplifier, SOT-89 pkg.         | Qorvo     | TQP7M9103      |
| C1, C6         | 1.5 pF | Cap., Chip, 0603, +/-0.05pF, 50V, Accu-P | AVX       | 06032U1R5BAT2A |
| C2, C3         | 22 pF  | Cap., Chip, 0603, 5%, 50V, NPO/COG       | various   |                |
| C4             | 0.1 uF | Cap., Chip, 0603, 10%, 16V, X7R          | various   |                |
| C5             | 1.0 uF | Cap., Chip, 0603, 10%, 10V, X5R          | various   |                |
| C7             | 1.2 pF | Cap., Chip, 0603, +/-0.05pF, 50V, Accu-P | AVX       | 06035J1R2ABSTR |
| C8             | 0.6 pF | Cap., Chip, 0603, +/-0.05pF, 50V, Accu-P | AVX       | 06035J0R6ABSTR |
| R1, R2         | 0 Ω    | Resistor, Chip, 0603, 5%, 1/16W          | various   |                |
| L1             | 33 nH  | Inductor, 0805, 5%, Coilcraft CS Series  | Coilcraft | 0805CS-330XJLB |

## Typical Performance, TQP7M9103-PCB2140

Test conditions unless otherwise noted:  $V_{CC} = +5\text{ V}$ ,  $I_{CQ} = 235\text{ mA}$ , Temp. =  $+25\text{ }^{\circ}\text{C}$

| Parameter                          | Conditions                                       | Typical Value |       |       | Units |
|------------------------------------|--|---------------|-------|-------|-------|
| Frequency                          |  | 2110          | 2140  | 2170  | MHz   |
| Gain                               |  | 16.7          | 16.6  | 16.6  | dB    |
| Input Return Loss                  |  | 11.7          | 12.0  | 11.7  | dB    |
| Output Return Loss                 |  | 16.5          | 16.0  | 15.2  | dB    |
| Output P1dB                        |  | +29.5         | +29.5 | +29.6 | dBm   |
| OIP3                               | Pout = +11 dBm / tone, $\Delta f = 1\text{ MHz}$ | +45.0         | +45.0 | +45.0 | dBm   |
| WCDMA Channel Power <sup>(1)</sup> | ACLR = -50 dBc                                   | +20           | +20   | +20   | dBm   |
| Noise figure                       |  | 4.4           | 4.4   | 4.6   | dB    |

Notes:

- 3GPP WCDMA, TM1+64 DPCH, +5 MHz offset, PAR = 10.2 dB at 0.01% Prob.

## Performance Plots, TQP7M9103-PCB2140

Test conditions unless otherwise noted:  $V_{CC} = +5\text{ V}$ ,  $I_{CQ} = 235\text{ mA}$ , Temp. =  $+25\text{ }^{\circ}\text{C}$

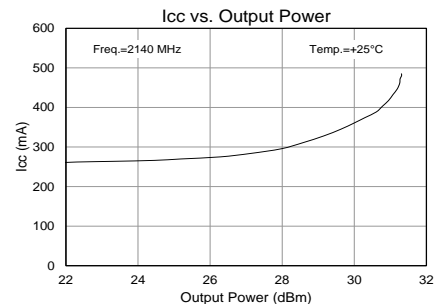
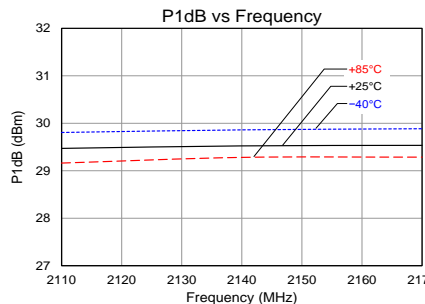
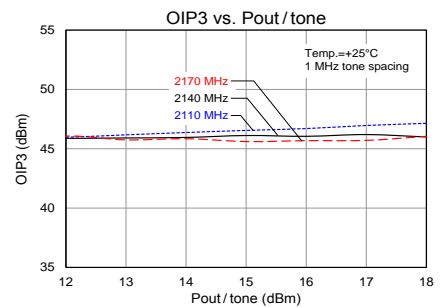
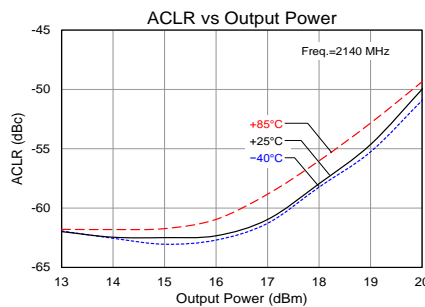
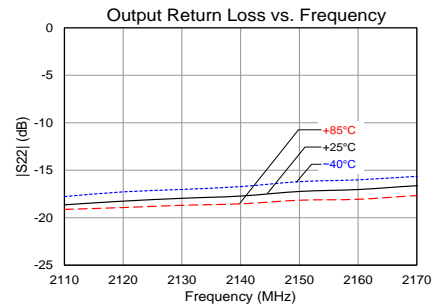
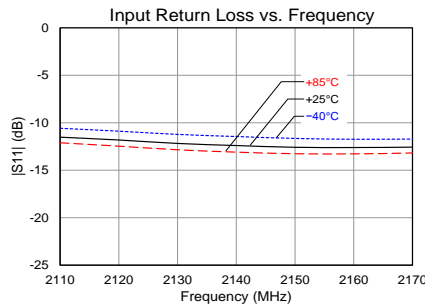
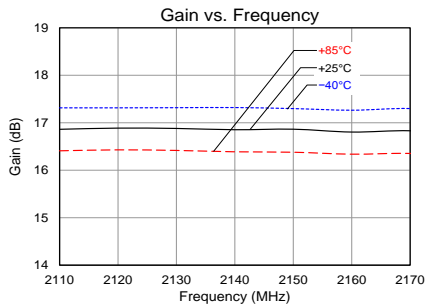

## Evaluation Board, 2300 – 2400 MHz Reference Design

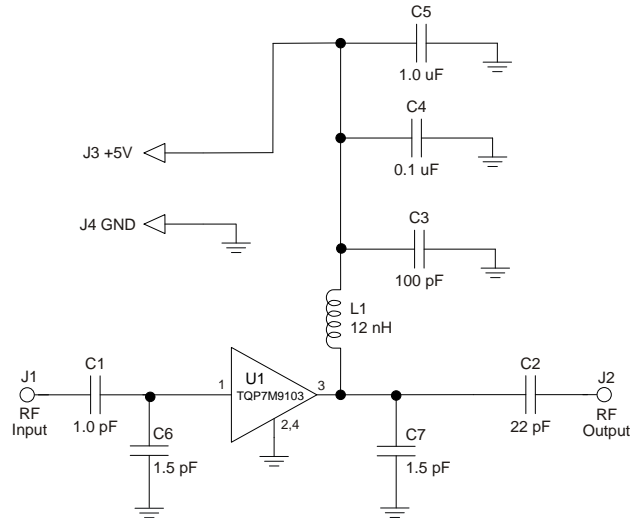
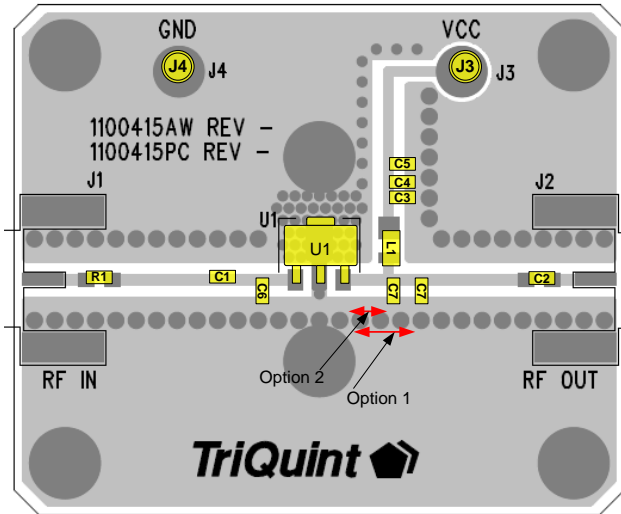

**Notes:**

- 14. Components shown on the silkscreen but not on the schematic are not used.
- 15. 0 Ω resistor can be replaced with copper trace in the target application layout.
- 16. All components are of 0603 size unless stated on the schematic.
- 17. The recommended component values are dependent upon the frequency of operation.
- 18. Critical component placement locations:
  - Distance between U1 Pin 1(left edge) to C1 (right edge): 135 mil
  - Distance between U1 Pin 1(left edge) to C6 (right edge): 30 mil
  - Distance between U1 Pin 3(right edge) to C7 (left edge): 145 mil for Option 1 and 85 mil for Option 2

## Bill of Material, 2300 – 2400 MHz

| Reference Des. | Value  | Description                        | Manuf.    | Part Number        |
|----------------|--------|------------------------------------|-----------|--------------------|
| n/a            | n/a    | Printed Circuit Board              | Qorvo     |                    |
| U1             | n/a    | 1 W High Linearity Amplifier       | Qorvo     | TQP7M9103          |
| C1             | 1 pF   | CAP, 0603, +/-0.1pF, 100V, NPO/COG | Murata    | GQM1885C2A1R0BB01J |
| C6, C7         | 1.5 pF | CAP, 0603, +/-0.1pF, 100V, NPO/COG | Murata    | GQM1885C2A1R5BB01J |
| C3             | 100 pF | CAP, 0603                          | various   |                    |
| C2             | 22 pF  | CAP, 0603                          | various   |                    |
| C4             | 0.1 uF | CAP, chip, 0603                    | Various   |                    |
| C5             | 1.0 uF | CAP, 0603, 10%, X5R , 10V          | Various   |                    |
| R1             | 0 Ω    | RES, chip, 0603                    | Various   |                    |
| L1             | 12 nH  | IND, 0805, 5%, Wirewound           | Coilcraft | 0805CS-120XJL      |



### Typical Performance (Option 1)

Test Conditions:  $V_{CC}=+5\text{ V}$ ,  $\text{Temp.}=+25^{\circ}\text{C}$ ,  $50\Omega$  System

| Parameter                             | Conditions                                   | Typical Value |       |       | Units |
|---------------------------------------|--|---------------|-------|-------|-------|
| Frequency                             |  | 2300          | 2350  | 2400  | MHz   |
| Gain                                  |  | 16.6          | 16.6  | 16.5  | dB    |
| Input Return Loss                     |  | 13.3          | 16    | 15    | dB    |
| Output Return Loss                    |  | 16.2          | 16.4  | 16.4  | dB    |
| Output P1dB                           |  | +29.3         | +29.4 | +29.4 | dBm   |
| Output IP3                            | Pout= +18 dBm/tone, $\Delta f= 1\text{ MHz}$ | +44           | +43.9 | +43.6 | dBm   |
| Quiescent Collector Current, $I_{CQ}$ |  | 225           |       |       | mA    |

### Typical Performance (Option 2)

Test Conditions:  $V_{CC}=+5\text{ V}$ ,  $\text{Temp.}=+25^{\circ}\text{C}$ ,  $50\Omega$  System

| Parameter                             | Conditions                                   | Typical Value |       |       | Units |
|---------------------------------------|--|---------------|-------|-------|-------|
| Frequency                             |  | 2300          | 2350  | 2400  | MHz   |
| Gain                                  |  | 16.2          | 16.2  | 16.2  | dB    |
| Input Return Loss                     |  | 14.5          | 19    | 20    | dB    |
| Output Return Loss                    |  | 9.7           | 9.6   | 9.8   | dB    |
| Output P1dB                           |  | +30           | +30.1 | +30.3 | dBm   |
| Output IP3                            | Pout= +18 dBm/tone, $\Delta f= 1\text{ MHz}$ | +41.6         | +41.5 | +41.1 | dBm   |
| Quiescent Collector Current, $I_{CQ}$ |  | 225           |       |       | mA    |

### Performance Plots, 2300 – 2400 MHz

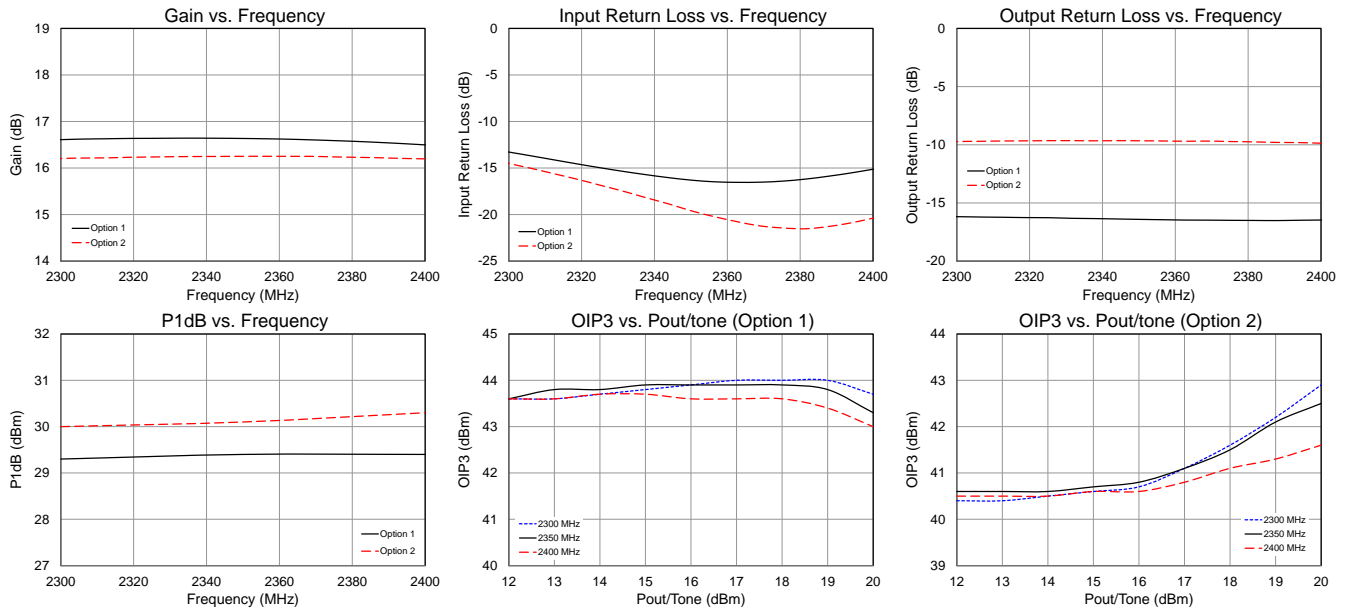

**Evaluation Board, 2500 – 2700 MHz Reference Design**

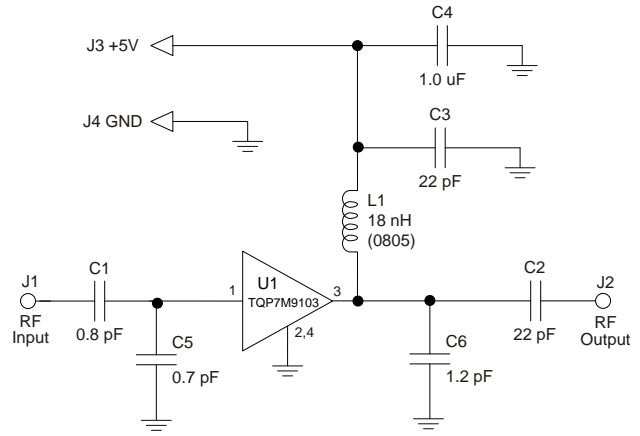
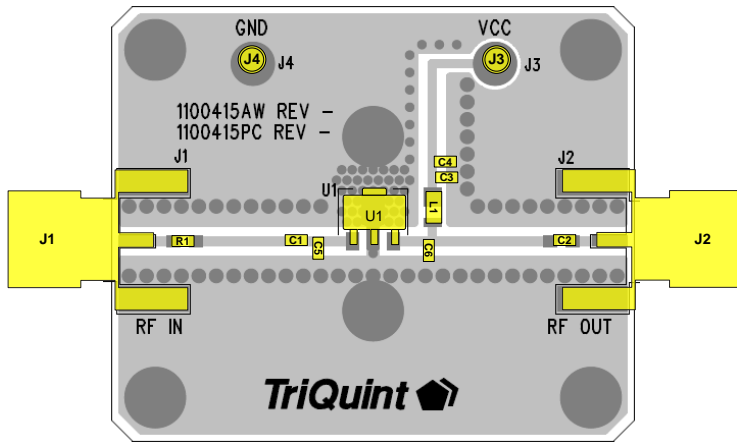

**Notes:**

- 19. Components shown on the silkscreen but not on the schematic are not used.
- 20. 0 Ω resistor can be replaced with copper trace in the target application layout.
- 21. All components are of 0603 size unless stated on the schematic.
- 22. The recommended component values are dependent upon the frequency of operation.
- 23. Critical component placement locations:
  - Distance between U1 Pin 1 Pad to C5 (right edge): 80 mil
  - Distance between U1 Pin 1 Pad to C1 (right edge): 120 mil
  - Distance between U1 Pin 3 Pad to C6 (left edge): 55 mil

**Bill of Material, 2500 – 2700 MHz**

| Reference Des. | Value  | Description                        | Manuf.    | Part Number    |
|----------------|--------|------------------------------------|-----------|----------------|
| n/a            | n/a    | Printed Circuit Board              | Qorvo     | 1100415        |
| U1             | n/a    | 1 W High Linearity Amplifier       | Qorvo     | TQP7M9103      |
| C1             | 0.8 pF | CAP, 0603, ± 0.1 pF, 100V, NPO/COG | AVX       | 06032U0R8BAT2A |
| C5             | 0.7 pF | CAP, 0603, ± 0.05 pF, 50V, ACCU-P  | AVX       | 06035J0R7ABSTR |
| C2, C3         | 22 pF  | CAP, 0603, 5%, 50V, NPO/COG        | various   |                |
| C4             | 1.0 uF | CAP, 0603, 10%, X5R , 10V          | various   |                |
| C6             | 1.2 pF | CAP, 0603, ± 0.1 pF, 100V, NPO/COG | AVX       | 06035J1R2ABSTR |
| R1             | 0 Ω    | RES, 0603, 5%, 1/16W, Chip         | various   |                |
| L1             | 18 nH  | IND, 0805, 5%, Ceramic             | Coilcraft | 0805CS-180XJL  |

## Typical Performance, 2500 – 2700 MHz

Test conditions unless otherwise noted:  $V_{CC} = +5\text{ V}$ ,  $I_{CQ} = 235\text{ mA}$ ,  $Temp. = +25\text{ }^\circ\text{C}$

| Parameter                          | Conditions  | Typical Value |       |       | Units |
|------------------------------------|---|---------------|-------|-------|-------|
| Frequency                          |   | 2500          | 2600  | 2700  | MHz   |
| Gain                               |   | 14.9          | 15.2  | 15.0  | dB    |
| Input Return Loss                  |   | -6.5          | -9.0  | -10.5 | dB    |
| Output Return Loss                 |   | -20.0         | -18.7 | -17.1 | dB    |
| Output P1dB                        |   | +29.7         | +29.6 | +29.8 | dBm   |
| OIP3                               | $P_{out} = +11\text{ dBm / tone, } \Delta f = 1\text{ MHz}$ | +43.7         | +43.7 | +44.1 | dBm   |
| WCDMA Channel Power <sup>(1)</sup> | ACLR = -50 dBc  | +20           | +20   | +20   | dBm   |

Notes:

- 3GPP WCDMA, TM1+64 DPCH, +5 MHz offset, PAR = 10.2 dB at 0.01% Prob.

## Performance Plots, 2500 – 2700 MHz

Test conditions unless otherwise noted:  $V_{CC} = +5\text{ V}$ ,  $I_{CQ} = 235\text{ mA}$ ,  $Temp. = +25\text{ }^\circ\text{C}$

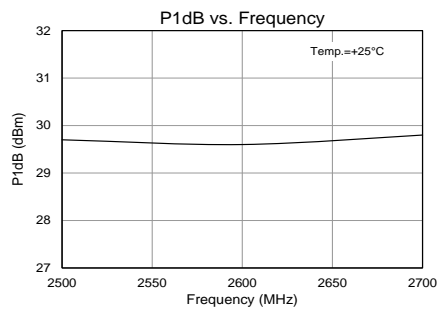
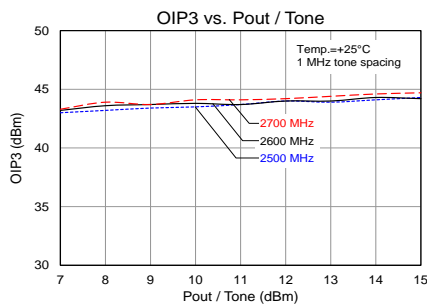
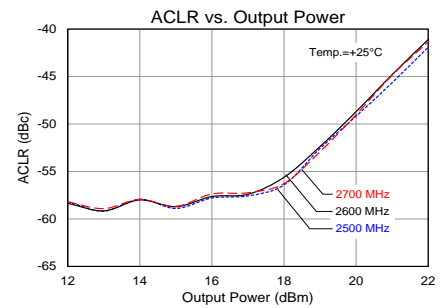
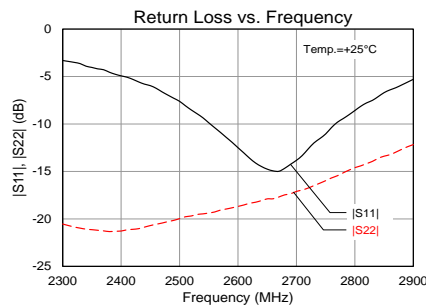
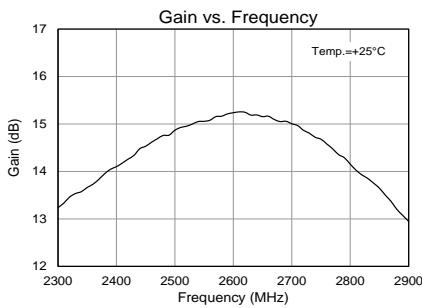

**Evaluation Board, 3400 – 3600 MHz Reference Design**

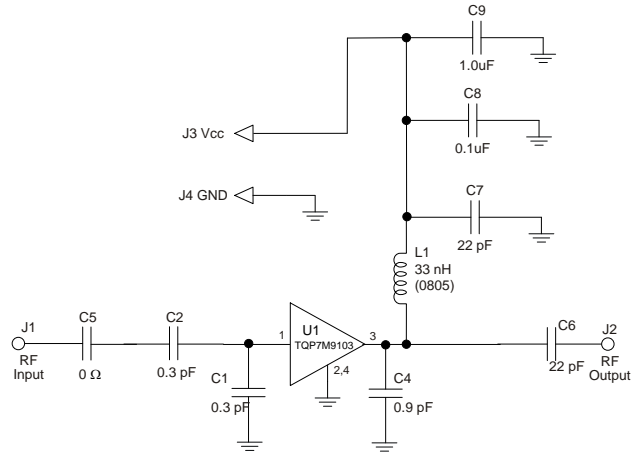

**Notes:**

1. All components are of 0603 size unless stated on the schematic.
2. Distance from right edge of C1 to device pin is 43mil
3. Distance from right edge of C2 to device pin is 75mil
4. Distance from right edge of C4 to device pin is 15mil

**Bill of Material, 3400 – 3600 MHz**

| Reference Des. | Value  | Description                             | Manuf.    | Part Number    |
|----------------|--------|---|-----------|----------------|
| n/a            | n/a    | Printed Circuit Board                   | Qorvo     |                |
| U1             | n/a    | TQP7M9103 Amplifier, SOT-89 pkg.        | Qorvo     |                |
| C1, C2         | 0.3 pF | Cap., Chip, 0603, +/-10.05pF, 50V       | AVX       | 06035J0R3ABSTR |
| C4             | 0.9 pF | Cap., Chip, 0603, 5%, 50V, NPO/COG      | AVX       | 06035J0R9ABSTR |
| C6, C7         | 22 pF  | Cap., Chip, 0603, 5%, 50V, NPO/COG      | various   |                |
| C8             | 0.1 uF | Cap., Chip, 0603, 10%, 16V, X7R         | various   |                |
| C9             | 1 uF   | Cap., Chip, 0603, 10%, 10V, X5R         | various   |                |
| L1             | 33 nH  | Inductor, 0603, 5%, Coilcraft CS Series | Coilcraft | 0603CS-33NXJL  |
| C5             | 0 Ω    | Res, chip, 0603                         | various   |                |

## Typical Performance, 3400 – 3600 MHz

Test conditions unless otherwise noted:  $V_{CC} = +5\text{ V}$ ,  $I_{CQ} = 235\text{ mA}$ ,  $Temp. = +25\text{ }^\circ\text{C}$

| Parameter          | Conditions  | Typical Value |       |       | Units |
|--------------------|---|---------------|-------|-------|-------|
| Frequency          |   | 3400          | 3500  | 3600  | MHz   |
| Gain               |   | 13.1          | 13.5  | 13    | dB    |
| Input Return Loss  |   | 8.2           | 17    | 11    | dB    |
| Output Return Loss |   | 18.5          | 16    | 13.7  | dB    |
| Output P1dB        |   | +29.2         | +29.2 | +28.9 | dBm   |
| Output IP3         | $P_{out} = +10\text{ dBm / tone, } \Delta f = 1\text{ MHz}$ | +41           | +40.4 | +39.7 | dBm   |

## Performance Plots, 3400 – 3600 MHz

Test conditions unless otherwise noted:  $V_{CC} = +5\text{ V}$ ,  $I_{CQ} = 235\text{ mA}$ ,  $Temp. = +25\text{ }^\circ\text{C}$

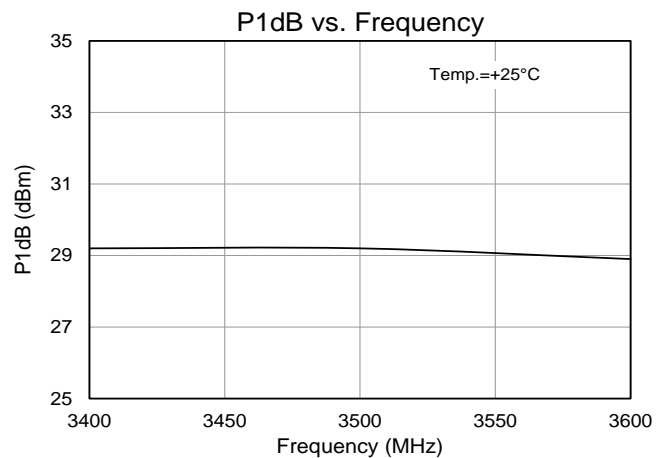
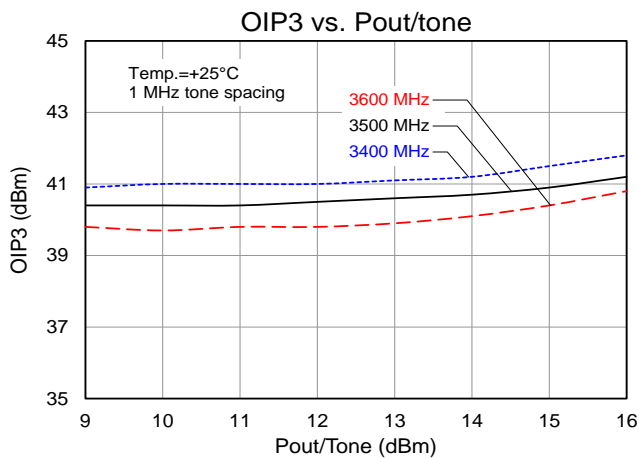
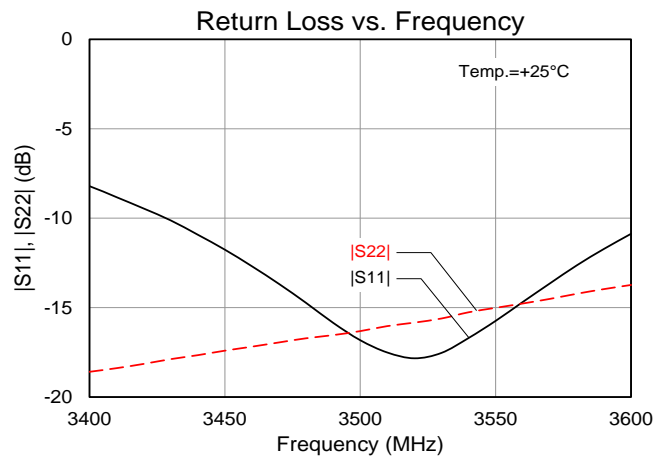
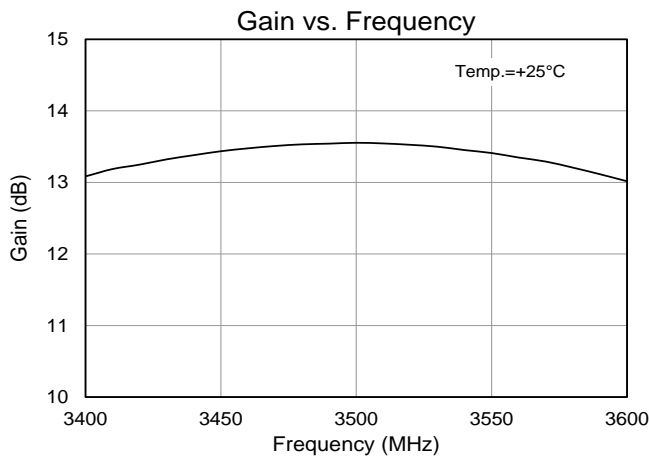

**Pin Configuration and Description**



| Pin No. | Label        | Description   |
|---------|--------------|---|
| 1       | RF IN        | RF Input. Requires external match for optimal performance. External DC Block required.                        |
| 2, 4    | GND          | RF/DC Ground Connection   |
| 3       | RF OUT / Vcc | RF Output. Requires external match for optimal performance. External DC Block and supply voltage is required. |

**Evaluation Board PCB Information**

Qorvo PCB 1080068 Material and Stack-up



50 ohm line dimensions: width = .028", spacing = .028".

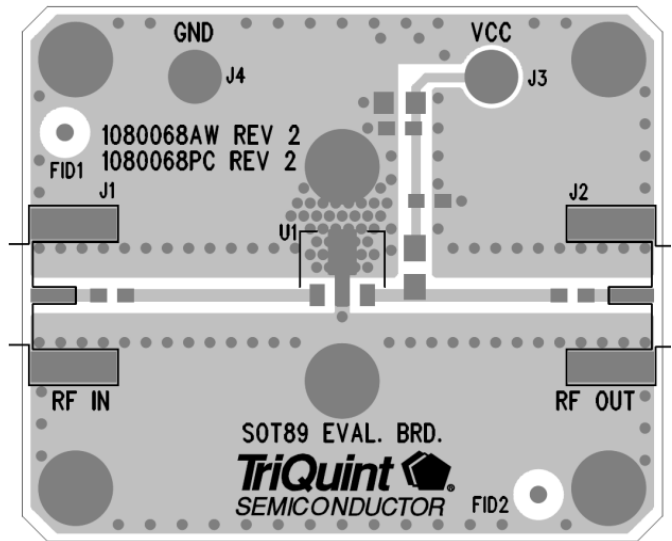

Package Marking and Dimensions

Marking: Part Identifier – 7M9103  
Lot code – YXXX

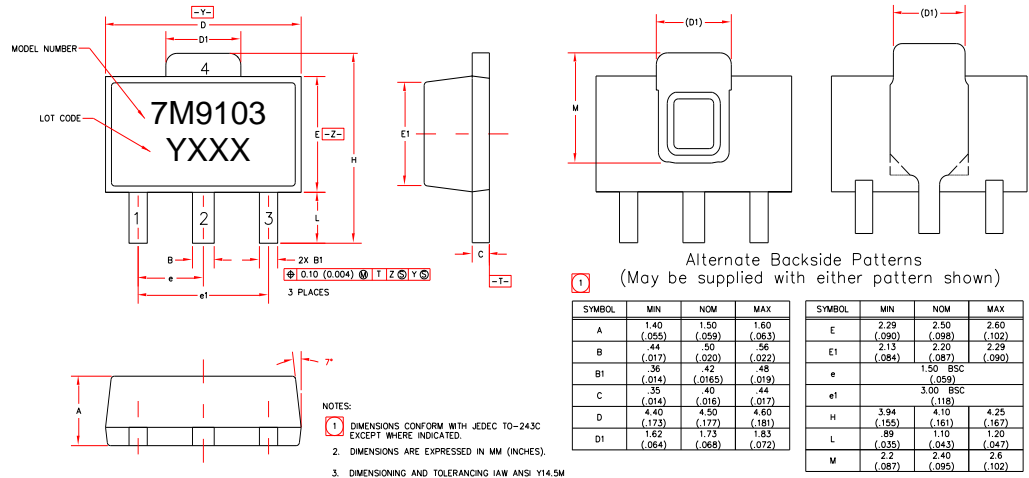

Notes:

1. All dimensions are in millimeters. Angles are in degrees.
2. Dimension and tolerance formats conform to ASME Y14.4M-1994.
3. The terminal #1 identifier and terminal numbering conform to JESD 95-1 SPP-012.
4. Contact plating: NiPdAu

PCB Mounting Pattern

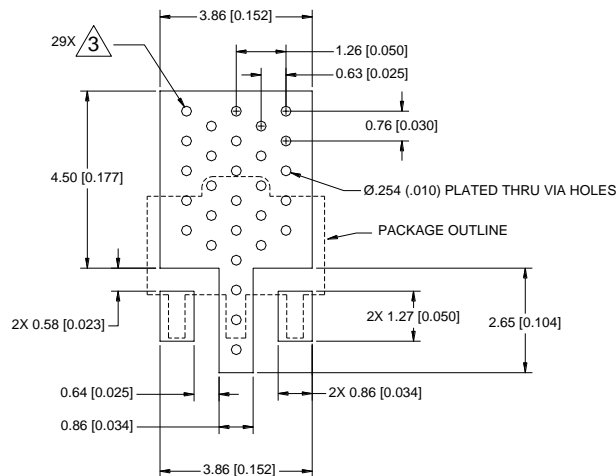

NOTES:

1. All dimensions are in millimeters [inches]. Angles are in degrees.
2. Use 1 oz. copper minimum for top and bottom layer metal.
3. Vias are required under the backside paddle of this device for proper RF/DC grounding and thermal dissipation. We recommend a 0.35mm (#80/.0135") diameter bit for drilling via holes and a final plated thru diameter of 0.25mm (0.10").
4. Ensure good package backside paddle solder attach for reliable operation and best electrical performance.

## Handling Precautions

| Parameter                        | Rating  | Standard                 |
|----------------------------------|---------|--------------------------|
| ESD – Human Body Model (HBM)     | 2       | ESDA / JEDEC JS-001-2012 |
| ESD – Charged Device Model (CDM) | C3      | JEDEC JESD22-C101F       |
| MSL – Moisture Sensitivity Level | Level 3 | IPC/JEDEC J-STD-020      |



Caution!  
ESD-Sensitive Device

## Solderability

Compatible with both lead-free (260°C max. reflow temp.) and tin/lead (245°C max. reflow temp.) soldering processes. Solder profiles available upon request.

Contact plating: NiPdAu

## RoHS Compliance

This part is compliant with the 2011/65/EU RoHS directive (Restrictions on the Use of Certain Hazardous Substances in Electrical and Electronic Equipment) as amended by Directive 2015/863/EU. This product also has the following attributes:

- Product uses RoHS Exemption 7c-I to meet RoHS Compliance requirements.
- Halogen Free (Chlorine, Bromine)
- Antimony Free
- TBBP-A (C<sub>15</sub>H<sub>12</sub>Br<sub>4</sub>O<sub>2</sub>) Free
- PFOS Free
- SVHC Free

## Contact Information

For the latest specifications, additional product information, worldwide sales and distribution locations:

**Web:** [www.qorvo.com](http://www.qorvo.com)

**Tel:** 1-844-890-8163

**Email:** [customer.support@qorvo.com](mailto:customer.support@qorvo.com)

For technical questions and application information:

**Email:** [appsupport@qorvo.com](mailto:appsupport@qorvo.com)

## Important Notice

The information contained herein is believed to be reliable; however, Qorvo makes no warranties regarding the information contained herein and assumes no responsibility or liability whatsoever for the use of the information contained herein. All information contained herein is subject to change without notice. Customers should obtain and verify the latest relevant information before placing orders for Qorvo products. The information contained herein or any use of such information does not grant, explicitly or implicitly, to any party any patent rights, licenses, or any other intellectual property rights, whether with regard to such information itself or anything described by such information. **THIS INFORMATION DOES NOT CONSTITUTE A WARRANTY WITH RESPECT TO THE PRODUCTS DESCRIBED HEREIN, AND QORVO HEREBY DISCLAIMS ANY AND ALL WARRANTIES WITH RESPECT TO SUCH PRODUCTS WHETHER EXPRESS OR IMPLIED BY LAW, COURSE OF DEALING, COURSE OF PERFORMANCE, USAGE OF TRADE OR OTHERWISE, INCLUDING THE IMPLIED WARRANTIES OF MERCHANTABILITY AND FITNESS FOR A PARTICULAR PURPOSE.**

Without limiting the generality of the foregoing, Qorvo products are not warranted or authorized for use as critical components in medical, life-saving, or life-sustaining applications, or other applications where a failure would reasonably be expected to cause severe personal injury or death.

Copyright 2018 © Qorvo, Inc. | Qorvo is a registered trademark of Qorvo, Inc.



Компания «Океан Электроники» предлагает заключение долгосрочных отношений при поставках импортных электронных компонентов на взаимовыгодных условиях!

Наши преимущества:

- Поставка оригинальных импортных электронных компонентов напрямую с производств Америки, Европы и Азии, а так же с крупнейших складов мира;
- Широкая линейка поставок активных и пассивных импортных электронных компонентов (более 30 млн. наименований);
- Поставка сложных, дефицитных, либо снятых с производства позиций;
- Оперативные сроки поставки под заказ (от 5 рабочих дней);
- Экспресс доставка в любую точку России;
- Помощь Конструкторского Отдела и консультации квалифицированных инженеров;
- Техническая поддержка проекта, помощь в подборе аналогов, поставка прототипов;
- Поставка электронных компонентов под контролем ВП;
- Система менеджмента качества сертифицирована по Международному стандарту ISO 9001;
- При необходимости вся продукция военного и аэрокосмического назначения проходит испытания и сертификацию в лаборатории (по согласованию с заказчиком);
- Поставка специализированных компонентов военного и аэрокосмического уровня качества (Xilinx, Altera, Analog Devices, Intersil, Interpoint, Microsemi, Actel, Aeroflex, Peregrine, VPT, Syfer, Eurofarad, Texas Instruments, MS Kennedy, Miteq, Cobham, E2V, MA-COM, Hittite, Mini-Circuits, General Dynamics и др.);

Компания «Океан Электроники» является официальным дистрибьютором и эксклюзивным представителем в России одного из крупнейших производителей разъемов военного и аэрокосмического назначения «JONHON», а так же официальным дистрибьютором и эксклюзивным представителем в России производителя высокотехнологичных и надежных решений для передачи СВЧ сигналов «FORSTAR».



## JONHON

«JONHON» (основан в 1970 г.)

Разъемы специального, военного и аэрокосмического назначения:

(Применяются в военной, авиационной, аэрокосмической, морской, железнодорожной, горно- и нефтедобывающей отраслях промышленности)

«FORSTAR» (основан в 1998 г.)

ВЧ соединители, коаксиальные кабели, кабельные сборки и микроволновые компоненты:

(Применяются в телекоммуникациях гражданского и специального назначения, в средствах связи, РЛС, а так же военной, авиационной и аэрокосмической отраслях промышленности).



Телефон: 8 (812) 309-75-97 (многоканальный)

Факс: 8 (812) 320-03-32

Электронная почта: [ocean@oceanchips.ru](mailto:ocean@oceanchips.ru)

Web: <http://oceanchips.ru/>

Адрес: 198099, г. Санкт-Петербург, ул. Калинина, д. 2, корп. 4, лит. А