

Single-Cell Li-Ion/Li-Polymer Battery Charge Management Controller with Input Overvoltage Protection

Features:

- Complete Linear Charge Management Controller:
 - Integrated Input Overvoltage Protection
 - Integrated Pass Transistor
 - Integrated Current Sense
 - Integrated Reverse Discharge Protection
- Constant Current/Constant Voltage Operation with Thermal Regulation
- 4.15V Undervoltage Lockout (UVLO)
- 18V Absolute Maximum Input with OVP:
 - 6.5V (MCP73113)
 - 5.8V (MCP73114)
- High Accuracy Preset Voltage Regulation Through Full Temperature Range (-5°C to +55°C): ±0.5%
- Battery Charge Voltage Options:
 - 4.10V, 4.20V, 4.35V or 4.4V
- Resistor Programmable Fast Charge Current:
 - 130 mA-1100 mA
- Preconditioning of Deeply Depleted Cells:
 - Available Options: 10% or Disable
- Integrated Precondition Timer:
 - 32 Minutes or Disable
- Automatic End-of-Charge Control:
 - Selectable Minimum Current Ratio: 5%, 7.5%, 10% or 20%
 - Elapse Safety Timer: 4 HR, 6 HR, 8 HR or Disable
- Automatic Recharge:
 - Available Options: 95% or Disable
- Charge Status Output-Two Style Options
- Soft start
- Temperature Range: -40°C to +85°C
- Packaging: DFN-10 (3 mm x 3 mm)

Applications:

- Low-Cost Li-Ion/Li-Poly Battery Chargers
- MP3 Players
- Digital Still Camera
- Portable Media Players
- Handheld Devices
- Bluetooth® Headsets
- USB Chargers

Description:

The MCP73113/4 are highly integrated Li-Ion battery charge management controllers for use in space-limited and cost-sensitive applications. The MCP73113/4 devices provide specific charge algorithms for Li-Ion/Li-Polymer batteries to achieve optimal capacity and safety in the shortest charging time possible. Along with their small physical size, the low number of external components make the MCP73113/4 ideally suitable for portable applications. The absolute maximum voltage, up to 18V, allows the use of MCP73113/4 in harsh environments, such as low cost wall wart or voltage spikes from plug/unplug.

The MCP73113/4 devices employ a constant current/constant voltage charge algorithm. The various charging voltage regulations provide design engineers flexibility to use in different applications. The fast charge, constant current value is set with one external resistor from 130 mA to 1100 mA. The MCP73113/4 devices limit the charge current based on die temperature during high power or high ambient conditions. This thermal regulation optimizes the charge cycle time while maintaining device reliability.

The PROG pin of the MCP73113/4 also serves as enable pin. When high-impedance is applied, the MCP73113/4 will be in Standby mode.

The MCP73113/4 devices are fully specified over the ambient temperature range of -40°C to +85°C. They are available in a 10-lead, DFN package.

Package Types (Top View)



MCP73113/4

Typical Application



TABLE 1: AVAILABLE FACTORY PRESET OPTIONS

Charge Voltage	OVP	Pre-conditioning Charge Current	Pre-conditioning Threshold	Precondition Timer	Elapse Timer	End-of-Charge Control	Automatic Recharge	Output Status
4.10V	5.8V/6.5V	Disable/10%	66.5%/71.5%	Disable/ 32 Minimum	Disable/4 HR/ 6 HR/8 HR	5%/7.5%/ 10%/20%	No/Yes	Type 1/ Type 2
4.20V	5.8V/6.5V	Disable/10%	66.5%/71.5%	Disable/ 32 Minimum	Disable/4 HR/ 6 HR/8 HR	5%/7.5%/ 10%/20%	No/Yes	Type 1/ Type 2
4.35V	5.8V/6.5V	Disable/10%	66.5%/71.5%	Disable/ 32 Minimum	Disable/4 HR/ 6 HR/8 HR	5%/7.5%/ 10%/20%	No/Yes	Type 1/ Type 2
4.40V	5.8V/6.5V	Disable/10%	66.5%/71.5%	Disable/ 32 Minimum	Disable/4 HR/ 6 HR/8 HR	5%/7.5%/ 10%/20%	No/Yes	Type 1/ Type 2

- Note 1:** I_{REG} : Regulated fast charge current.
2: V_{REG} : Regulated charge voltage.
3: I_{PREG}/I_{REG} : Preconditioning charge current; ratio of regulated fast charge current.
4: I_{TERM}/I_{REG} : End-of-Charge control; ratio of regulated fast charge current.
5: MCP73113: $V_{OVP} = 6.5V$, MCP73114: $V_{OVP} = 5.8V$.
6: V_{RTH}/V_{REG} : Recharge threshold; ratio of regulated battery voltage, 0% or 95%. 0% = Disabled.
7: V_{PTH}/V_{REG} : Preconditioning threshold voltage.
8: Output Status: Type 1 Fault Output Status = High-Z, Type 2 Fault Output Status = Flashing.

TABLE 2: STANDARD SAMPLE OPTIONS

Part Number	V_{REG}	OVP	I_{PREG}/I_{REG}	Pre-charge Timer	Elapse Timer	I_{TERM}/I_{REG}	Auto Recharge Threshold (0%=Disabled)	V_{PTH}/V_{REG}	Output Status
MCP73113-16S/MF	4.10V	6.5V	10%	32 Min.	6 HR	10%	95%	71.5%	Type 1
MCP73113-06S/MF	4.20V	6.5V	10%	32 Min.	6 HR	10%	95%	71.5%	Type 1
MCP73114-0NS/MF	4.20V	5.8V	10%	32 Min.	6 HR	10%	95%	71.5%	Type 1

- Note 1:** Customers should contact their distributor, representatives or field application engineer (FAE) for support and sample. Local sales offices are also available to help customers. A listing of sales offices and locations is included in the back of this document. Technical support is available through the web site at: <http://support.microchip.com>.

Functional Block Diagram



MCP73113/4

NOTES:

1.0 ELECTRICAL CHARACTERISTICS

Absolute Maximum Ratings†

V_{DD}	18.0V
V_{PROG}	6.0V
All Inputs and Outputs w.r.t. V_{SS}	-0.3 to ($V_{DD}+0.3$)V
Maximum Junction Temperature, T_J	Internally Limited
Storage temperature	-65°C to +150°C
ESD protection on all pins	
Human Body Model (1.5 k Ω in Series with 100 pF)	≥ 4 kV
Machine Model (200 pF, No Series Resistance)	300V

† **Notice:** Stresses above those listed under “Maximum Ratings” may cause permanent damage to the device. This is a stress rating only and functional operation of the device at those or any other conditions above those indicated in the operational listings of this specification is not implied. Exposure to maximum rating conditions for extended periods may affect device reliability.

DC CHARACTERISTICS

Electrical Specifications: Unless otherwise indicated, all limits apply for $V_{DD} = [V_{REG}(\text{Typical}) + 0.3V]$ to 6V, $T_A = -40^\circ\text{C}$ to $+85^\circ\text{C}$. Typical values are at $+25^\circ\text{C}$, $V_{DD} = [V_{REG}(\text{Typical}) + 1.0V]$						
Parameters	Sym.	Min.	Typ.	Max.	Units	Conditions
Supply Input						
Input Voltage Range	V_{DD}	4	—	16	V	
Operating Supply Voltage	V_{DD}	4.2	—	6.5	V	
Supply Current	I_{SS}	—	4	5.5	μA	Shutdown ($V_{DD} \leq V_{BAT} - 150 \text{ mV}$)
		—	700	1500	μA	Charging
		—	30	100	μA	Standby (PROG Floating)
		—	50	150	μA	Charge Complete; No Battery; $V_{DD} < V_{STOP}$
Battery Discharge Current						
Output Reverse Leakage Current	$I_{DISCHARGE}$	—	0.5	2	μA	Standby (PROG Floating)
		—	0.5	2	μA	Shutdown ($V_{DD} \leq V_{BAT}$, or $V_{DD} < V_{STOP}$)
		—	6	17	μA	Charge Complete; V_{DD} is present
Undervoltage Lockout						
UVLO Start Threshold	V_{START}	4.10	4.15	4.25	V	
UVLO Stop Threshold	V_{STOP}	4.00	4.05	4.15	V	
UVLO Hysteresis	V_{HYS}	—	100	—	mV	
Overvoltage Protection						
OVP Start Threshold	V_{OVP}	6.4	6.5	6.6	V	MCP73113
		5.8	5.9	6.0	V	MCP73114
OVP Hysteresis	V_{OVPHYS}	—	150	—	mV	
Voltage Regulation (Constant-Voltage Mode)						
Regulated Output Voltage Options	V_{REG}	4.079	4.10	4.121	V	$T_A = -5^\circ\text{C}$ to 55°C $V_{DD} = [V_{REG}(\text{Typical})+1V]$ $I_{OUT} = 50 \text{ mA}$
		4.179	4.20	4.221	V	
		4.328	4.35	4.372	V	
		4.378	4.40	4.422	V	
Output Voltage Tolerance	V_{RTOL}	-0.5	—	0.5	%	
Line Regulation	$ \frac{\Delta V_{BAT}}{V_{BAT}} / \frac{\Delta V_{DD}}{V_{DD}} $	—	0.05	0.20	%/V	$V_{DD} = [V_{REG}(\text{Typical})+1V]$ to 6V $I_{OUT} = 50 \text{ mA}$
Load Regulation	$ \frac{\Delta V_{BAT}}{V_{BAT}} $	—	0.05	0.20	%	$I_{OUT} = 50 \text{ mA} - 150 \text{ mA}$ $V_{DD} = [V_{REG}(\text{Typical})+1V]$
Supply Ripple Attenuation	PSRR	—	-46	—	dB	$I_{OUT} = 20 \text{ mA}$, 10 Hz to 1 kHz
		—	-30	—	dB	$I_{OUT} = 20 \text{ mA}$, 10 Hz to 10 kHz

Note 1: Not production tested. Ensured by design.

MCP73113/4

DC CHARACTERISTICS (CONTINUED)

Electrical Specifications: Unless otherwise indicated, all limits apply for $V_{DD} = [V_{REG}(\text{Typical}) + 0.3V]$ to 6V, $T_A = -40^\circ\text{C}$ to $+85^\circ\text{C}$. Typical values are at $+25^\circ\text{C}$, $V_{DD} = [V_{REG}(\text{Typical}) + 1.0V]$						
Parameters	Sym.	Min.	Typ.	Max.	Units	Conditions
Battery Short Protection						
BSP Start Threshold	V_{SHORT}	—	1.7	—	V	
BSP Hysteresis	V_{BSPHYS}	—	150	—	mV	
BSP Regulation Current	I_{SHORT}	—	25	—	mA	
Current Regulation (Fast Charge, Constant-Current Mode)						
Fast Charge Current Regulation	I_{REG}	130	—	1100	mA	$T_A = -5^\circ\text{C}$ to $+55^\circ\text{C}$
		—	130	—	mA	PROG = 10 k Ω
		—	1000	—	mA	PROG = 1.1 k Ω
Charge Current Tolerance	I_{RTOL}	—	10	—	%	
Preconditioning Current Regulation (Trickle Charge Constant-Current Mode)						
Precondition Current Ratio	I_{PREG} / I_{REG}	8	10	15	%	PROG = 1 k Ω to 10 k Ω $T_A = -5^\circ\text{C}$ to $+55^\circ\text{C}$
		—	100	—	%	No Preconditioning
Precondition Voltage Threshold Ratio	V_{PTH} / V_{REG}	64	66.5	69	%	V_{BAT} Low-to-High
		69	71.5	74	%	
Precondition Hysteresis	V_{PHYS}	—	100	—	mV	V_{BAT} High-to-Low (Note 1)
Charge Termination						
Charge Termination Current Ratio	I_{TERM} / I_{REG}	3.75	5	6.25	%	PROG = 1 k Ω to 10 k Ω $T_A = -5^\circ\text{C}$ to $+55^\circ\text{C}$
		5.6	7.5	9.4	%	
		7.5	10	12.5	%	
		15	20	25	%	
Automatic Recharge						
Recharge Voltage Threshold Ratio	V_{RTH} / V_{REG}	93	95.0	97	%	V_{BAT} High-to-Low No Automatic Recharge
		—	0	—	%	
Pass Transistor ON-Resistance						
ON-Resistance	R_{DSON}	—	350	—	m Ω	$V_{DD} = 4.5V$, $T_J = 105^\circ\text{C}$ (Note 1)
Status Indicator – STAT						
Sink Current	I_{SINK}	—	20	35	mA	
Low Output Voltage	V_{OL}	—	0.2	0.5	V	$I_{SINK} = 4$ mA
Input Leakage Current	I_{LK}	—	0.001	1	μA	High-Impedance, V_{DD} on pin
PROG Input						
Charge Impedance Range	R_{PROG}	1	—	21	k Ω	
Shutdown Impedance	R_{PROG}	70	200	—	k Ω	Impedance for Shutdown
PROG Voltage Range	V_{PROG}	0	—	5	V	
Automatic Power Down						
Automatic Power Down Entry Threshold	$V_{PDENTRY}$	$V_{BAT} + 10$ mV	$V_{BAT} + 50$ mV	—	V	$2.3V \leq V_{BAT} \leq V_{REG}$ V_{DD} Falling
Automatic Power Down Exit Threshold	V_{PDEXIT}	—	$V_{BAT} + 150$ mV	$V_{BAT} + 250$ mV	V	$2.3V \leq V_{BAT} \leq V_{REG}$ V_{DD} Rising
Thermal Shutdown						
Die Temperature	T_{SD}	—	150	—	$^\circ\text{C}$	
Die Temperature Hysteresis	T_{SDHYS}	—	10	—	$^\circ\text{C}$	

Note 1: Not production tested. Ensured by design.

AC CHARACTERISTICS

Electrical Specifications: Unless otherwise specified, all limits apply for $V_{DD} = [V_{REG}(\text{Typical}) + 0.3V]$ to 6V, $T_A = -40^\circ\text{C}$ to $+85^\circ\text{C}$. Typical values are at $+25^\circ\text{C}$, $V_{DD} = [V_{REG}(\text{Typical}) + 1.0V]$

Parameters	Sym.	Min.	Typ.	Max.	Units	Conditions
Elapsed Timer						
Elapsed Timer Period	$t_{ELAPSED}$	—	0	—	Hours	Timer Disabled
		3.6	4.0	4.4	Hours	
		5.4	6.0	6.6	Hours	
		7.2	8.0	8.8	Hours	
Preconditioning Timer						
Preconditioning Timer Period	t_{PRECHG}	—	0	—	Hours	Disabled Timer
		0.4	0.5	0.6	Hours	
Status Indicator						
Status Output turn-off delay	t_{OFF}	—	—	500	μs	$I_{SINK} = 1 \text{ mA to } 0 \text{ mA}$ (Note 1)
Status Output turn-on delay	t_{ON}	—	—	500	μs	$I_{SINK} = 0 \text{ mA to } 1 \text{ mA}$ (Note 1)

Note 1: Not production tested. Ensured by design.

TEMPERATURE SPECIFICATIONS

Electrical Specifications: Unless otherwise indicated, all limits apply for $V_{DD} = [V_{REG}(\text{Typical}) + 0.3V]$ to 6V. Typical values are at $+25^\circ\text{C}$, $V_{DD} = [V_{REG}(\text{Typical}) + 1.0V]$

Parameters	Sym.	Min.	Typ.	Max.	Units	Conditions
Temperature Ranges						
Specified Temperature Range	T_A	-40	—	+85	$^\circ\text{C}$	
Operating Temperature Range	T_J	-40	—	+125	$^\circ\text{C}$	
Storage Temperature Range	T_A	-65	—	+150	$^\circ\text{C}$	
Thermal Package Resistances						
Thermal Resistance, DFN-10 (3x3)	θ_{JA}	—	64	—	$^\circ\text{C/W}$	4-Layer JC51-7 Standard Board, Natural Convection
	θ_{JC}	—	12	—	$^\circ\text{C/W}$	

MCP73113/4

NOTES:

2.0 TYPICAL PERFORMANCE CURVES

Note: The graphs and tables provided following this note are a statistical summary based on a limited number of samples and are provided for informational purposes only. The performance characteristics listed herein are not tested or guaranteed. In some graphs or tables, the data presented may be outside the specified operating range (e.g., outside specified power supply range) and therefore outside the warranted range.

Note: Unless otherwise indicated, $V_{DD} = [V_{REG}(\text{Typical}) + 1V]$, $I_{OUT} = 50 \text{ mA}$ and $T_A = +25^\circ\text{C}$, Constant-Voltage mode.



FIGURE 2-1: Battery Regulation Voltage (V_{BAT}) vs. Supply Voltage (V_{DD}).



FIGURE 2-4: Battery Regulation Voltage (V_{BAT}) vs. Ambient Temperature (T_A).

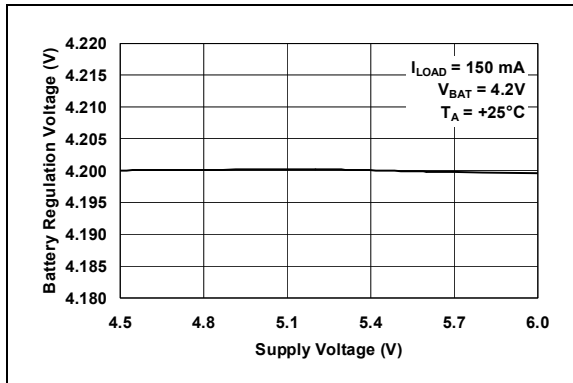

FIGURE 2-2: Battery Regulation Voltage (V_{BAT}) vs. Supply Voltage (V_{DD}).

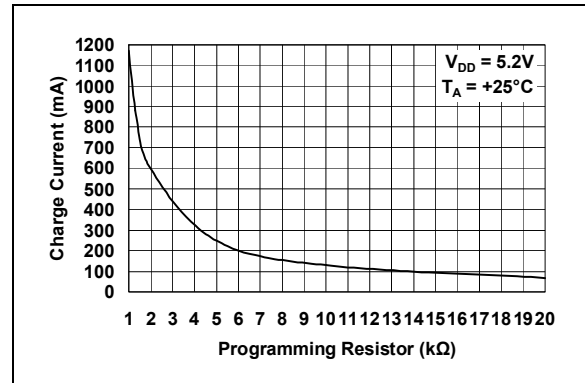

FIGURE 2-5: Charge Current (I_{OUT}) vs. Programming Resistor (R_{PROG}).

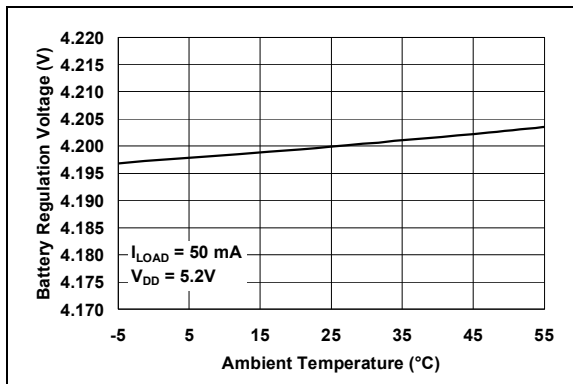

FIGURE 2-3: Battery Regulation Voltage (V_{BAT}) vs. Ambient Temperature (T_A).

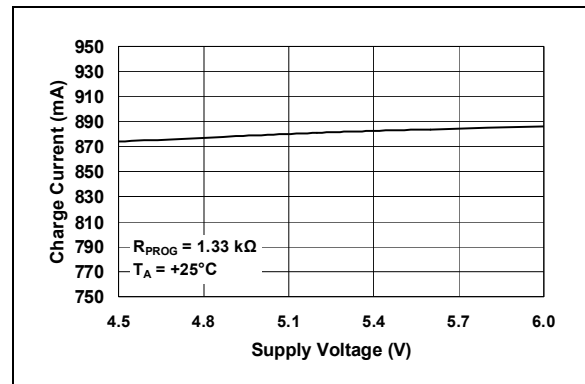

FIGURE 2-6: Charge Current (I_{OUT}) vs. Supply Voltage (V_{DD}).

MCP73113/4

TYPICAL PERFORMANCE CURVES (CONTINUED)

Note: Unless otherwise indicated, $V_{DD} = [V_{REG}(Typical) + 1V]$, $I_{OUT} = 10\text{ mA}$ and $T_A = +25^\circ\text{C}$, Constant-Voltage mode.

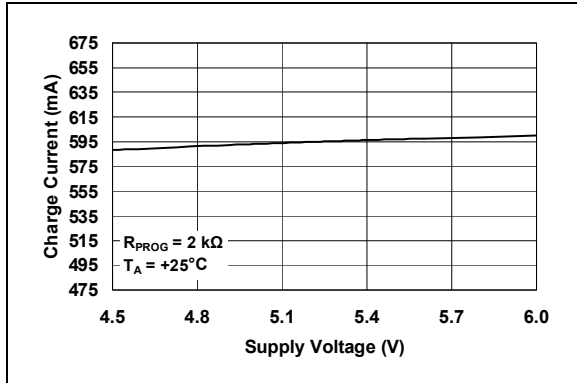

FIGURE 2-7: Charge Current (I_{OUT}) vs. Programming Resistor (R_{PROG}).

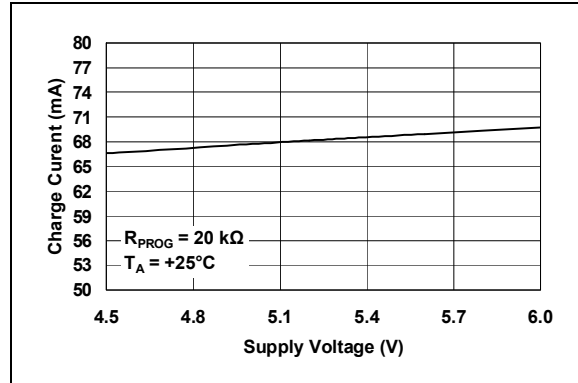

FIGURE 2-10: Charge Current (I_{OUT}) vs. Programming Resistor (R_{PROG}).



FIGURE 2-8: Charge Current (I_{OUT}) vs. Programming Resistor (R_{PROG}).



FIGURE 2-11: Charge Current (I_{OUT}) vs. Ambient Temperature (T_A).

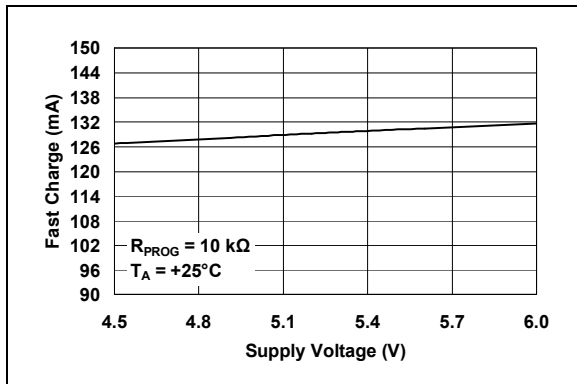

FIGURE 2-9: Charge Current (I_{OUT}) vs. Programming Resistor (R_{PROG}).

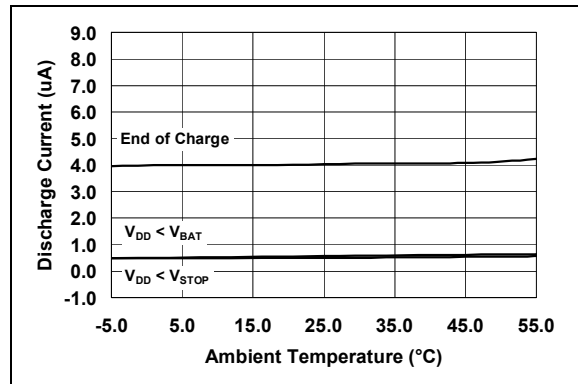

FIGURE 2-12: Output Leakage Current ($I_{DISCHARGE}$) vs. Ambient Temperature (T_A).

TYPICAL PERFORMANCE CURVES (CONTINUED)

Note: Unless otherwise indicated, $V_{DD} = [V_{REG}(Typical) + 1V]$, $I_{OUT} = 10\text{ mA}$ and $T_A = +25^\circ\text{C}$, Constant-Voltage mode.



FIGURE 2-13: Overvoltage Protection Start (50 ms/Div).



FIGURE 2-16: Complete Charge Cycle (875 mAh Li-Ion Battery).



FIGURE 2-14: Overvoltage Protection Stop (50 ms/Div).



FIGURE 2-17: Line Transient Response ($I_{LOAD} = 10\text{ mA}$, Output: 1.0V/Div, Source: 2.0V/Div).



FIGURE 2-15: Load Transient Response ($I_{LOAD} = 50\text{ mA}$, Output: 100 mV/Div, Time: 100 μs /Div).



FIGURE 2-18: Line Transient Response ($I_{LOAD} = 100\text{ mA}$, Output: 1.0V/Div, Source: 2.0V/Div).

MCP73113/4

NOTES:

3.0 PIN DESCRIPTION

The descriptions of the pins are listed in [Table 3-1](#).

TABLE 3-1: PIN FUNCTION TABLES

MCP73113/4	Symbol	I/O	Function
DFN-10			
1, 2	V _{DD}	I	Battery Management Input Supply
3, 4	V _{BAT}	I/O	Battery Charge Control Output
5, 6	NC	—	No Connection
7	STAT	O	Battery Charge Status Output
8, 9	V _{SS}	—	Battery Management 0V Reference
10	PROG	I/O	Battery Charge Current Regulation Program and Charge Control Enable
11	EP	—	Exposed Pad

3.1 Battery Management Input Supply (V_{DD})

A supply voltage of [V_{REG} (Typical) + 0.3V] to 6.0V is recommended. Bypass to V_{SS} with a minimum of 1 μF. The V_{DD} pin is rated 18V absolute maximum to prevent sudden rise of input voltage from spikes or low-cost AC-DC wall adapter.

3.2 Battery Charge Control Output (V_{BAT})

Connect to the positive terminal of the battery. Bypass to V_{SS} with a minimum of 1 μF to ensure loop stability when the battery is disconnected.

3.3 No Connect (NC)

No connect.

3.4 Battery Management 0V Reference (V_{SS})

Connect to the negative terminal of the battery and input supply.

3.5 Status Output (STAT)

STAT is an open-drain logic output for connection to an LED for charge status indication in stand-alone applications. Alternatively, a pull-up resistor can be applied for interfacing to a host microcontroller. Refer to [Table 5-2](#) for a summary of the status output during a charge cycle.

3.6 Current Regulation Set (PROG)

The fast charge current is set by placing a resistor from PROG to V_{SS} during Constant-Current (CC) mode. PROG pin is rated up to 5V with 6V absolute maximum value.

The PROG pin also serves as a charge control enable pin. Allowing the PROG pin to float or connecting the pin to an impedance greater than 200 kΩ will disable the MCP73113/4 charger. Refer to [Section 5.5 “Constant Current MODE – Fast Charge”](#) for details.

3.7 Exposed Pad (EP)

The Exposed Thermal Pad (EP) should be connected to the exposed copper area on the Printed Circuit Board (PCB) to enhance thermal power dissipation. Additional vias on the copper area under the MCP73113/4 device will improve the performance of heat dissipation and simplify the assembly process.

MCP73113/4

NOTES:

4.0 DEVICE OVERVIEW

The MCP73113/4 are simple, but fully integrated linear charge management controllers. Figure 4-1 depicts the operational flow algorithm.



FIGURE 4-1: The MCP73113/4 Flowchart.

MCP73113/4

NOTES:

5.0 DETAILED DESCRIPTION

5.1 Undervoltage Lockout (UVLO)

An internal undervoltage lockout (UVLO) circuit monitors the input voltage and keeps the charger in Shutdown mode until the input supply rises above the UVLO threshold. In the event a battery is present when the input power is applied, the input supply must rise approximately 150 mV above the battery voltage before the MCP73113/4 device becomes operational.

The UVLO circuit places the device in Shutdown mode if the input supply falls to approximately 150 mV above the battery voltage. The UVLO circuit is always active. At any time, the input supply is below the UVLO threshold or approximately 150 mV of the voltage at the V_{BAT} pin, the MCP73113/4 device is placed in a Shutdown mode.

5.2 Overvoltage Protection (OVP)

An internal overvoltage protection (OVP) circuit monitors the input voltage and keeps the charger in Shutdown mode when the input supply rises above the OVP threshold. The hysteresis of OVP is approximately 150 mV for the MCP73113/4 device.

The MCP73113/4 device is operational between UVLO and OVP threshold. The OVP circuit is also recognized as overvoltage lockout (OVLO).

5.3 Charge Qualification

When the input power is applied, the input supply must rise 150 mV above the battery voltage before the MCP73113/4 becomes operational.

The automatic power-down circuit places the device in a Shutdown mode if the input supply falls to within +50 mV of the battery voltage.

The automatic circuit is always active. At any time the input supply is within +50 mV of the voltage at the V_{BAT} pin, the MCP73113/4 is placed in a Shutdown mode.

For a charge cycle to begin, the automatic power-down conditions must be met and the charge enable input must be above the input high threshold.

5.3.1 BATTERY MANAGEMENT INPUT SUPPLY (V_{DD})

The V_{DD} input is the input supply to the MCP73113/4. The MCP73113/4 automatically enters a Power-Down mode if the voltage on the V_{DD} input falls to within +50 mV of the battery voltage. This feature prevents draining the battery pack when the V_{DD} supply is not present.

5.3.2 BATTERY CHARGE CONTROL OUTPUT (V_{BAT})

The battery charge control output is the drain terminal of an internal P-channel MOSFET. The MCP73113/4 devices provide constant current and voltage regulation to the battery pack by controlling this MOSFET in the linear region. The battery charge control output should be connected to the positive terminal of the battery pack.

5.3.3 BATTERY DETECTION

The MCP73113/4 detects the battery presence by monitoring the voltage at V_{BAT} . The charge flow will initiate when the voltage on V_{BAT} is below the $V_{RECHARGE}$ threshold. Refer to **Section 1.0 “Electrical Characteristics”** for $V_{RECHARGE}$ values. The value will be the same for the non-rechargeable device.

When $V_{BAT} > V_{REG} + \text{Hysteresis}$, the charge will be suspended or not started, depending on the current charge status, to prevent overcharging.

5.4 Preconditioning

If the voltage at the V_{BAT} pin is less than the preconditioning threshold, the MCP73113/4 device enters a Preconditioning mode. The preconditioning threshold is factory set. Refer to **Section 1.0 “Electrical Characteristics”** for preconditioning threshold options.

In this mode, the MCP73113/4 device supplies 10% of the fast charge current (established with the value of the resistor connected to the PROG pin) to the battery.

When the voltage at the V_{BAT} pin rises above the preconditioning threshold, the MCP73113/4 device enters the constant current (Fast Charge) mode.

Note: The MCP73113/4 also offer options with no preconditioning.

5.4.1 TIMER EXPIRED DURING PRECONDITIONING MODE

If the internal timer expires before the voltage threshold is reached for Fast Charge mode, a timer fault is indicated and the charge cycle terminates. The MCP73113/4 device remains in this condition until the battery is removed or input power is cycled. If the battery is removed, the MCP73113/4 device enters the Standby mode where it remains until a battery is reinserted.

Note: The typical preconditioning timer for MCP73113/4 is 32 minutes. The MCP73113/4 also offer options with no preconditioning timer.

MCP73113/4

5.5 Constant Current MODE – Fast Charge

During the Constant-Current mode, the programmed charge current is supplied to the battery or load.

The charge current is established using a single resistor from PROG to V_{SS}. The program resistor and the charge current are calculated using the following equations:

EQUATION 5-1:

$$I_{REG} = 1104 \times R^{-0.93}$$

Where:

R_{PROG} = kilo-ohms (kΩ)
 I_{REG} = milliamperes (mA)

EQUATION 5-2:

$$R_{PROG} = 10^{\frac{(\log(I_{REG})/(-0.93)) \log(1104)}{1}}$$

Where:

R_{PROG} = kilo-ohms (kΩ)
 I_{REG} = milliamperes (mA)

Table 5-1 provides commonly seen E96 (1%) and E24 (5%) resistors for various charge current to reduce design time.

TABLE 5-1: RESISTOR LOOK-UP TABLE

Charge Current (mA)	Recommended E96 Resistor (Ω)	Recommended E24 Resistor (Ω)
130	10k	10k
150	8.45k	8.20k
200	6.20k	6.20k
250	4.99k	5.10k
300	4.02k	3.90k
350	3.40k	3.30k
400	3.00k	3.00k
450	2.61k	2.70k
500	2.32k	2.37k
550	2.10k	2.20k
600	1.91k	2.00k
650	1.78k	1.80k
700	1.62k	1.60k
750	1.50k	1.50k
800	1.40k	1.50k
850	1.33k	1.30k
900	1.24k	1.20k
950	1.18k	1.20k
1000	1.10k	1.10k
1100	1.00k	1.00k

Constant-Current mode is maintained until the voltage at the V_{BAT} pin reaches the regulation voltage, V_{REG}. When Constant-Current mode is invoked, the internal timer is reset.

5.5.1 TIMER EXPIRED DURING CONSTANT CURRENT – FAST CHARGE MODE

If the internal timer expires before the recharge voltage threshold is reached, a timer fault is indicated and the charge cycle terminates. The MCP73113/4 device remains in this condition until the battery is removed. If the battery is removed or input power is cycled, the MCP73113/4 device enters the Standby mode where it remains until a battery is reinserted.

5.6 Constant-Voltage Mode

When the voltage at the V_{BAT} pin reaches the regulation voltage, V_{REG}, constant voltage regulation begins. The regulation voltage is factory set to 4.10V, 4.20V, 4.35V or 4.40V with a tolerance of ±0.5%.

5.7 Charge Termination

The charge cycle is terminated when, during Constant-Voltage mode, the average charge current diminishes below a threshold established with the value of 5%, 7.5%, 10% or 20% of fast charge current or internal timer has expired. A 1 ms filter time on the termination comparator ensures that transient load conditions do not result in premature charge cycle termination. The timer period is factory set and can be disabled. Refer to Section 1.0 “Electrical Characteristics” for timer period options.

5.8 Automatic Recharge

The MCP73113/4 device continuously monitors the voltage at the V_{BAT} pin in the Charge Complete mode. If the voltage drops below the recharge threshold, another charge cycle begins and current is once again supplied to the battery or load. The recharge threshold is factory set. Refer to Section 1.0 “Electrical Characteristics” for recharge threshold options.

Note: The MCP73113/4 also offer options with no automatic recharge.

For the MCP73113/4 devices with no recharge option, the MCP73113/4 will go into Standby mode when termination condition is met. The charge will not restart until at least one of the following conditions have been met:

- Battery is removed from the system and inserted again
- V_{DD} is removed and plugged in again
- R_{PROG} is disconnected (or high-impedance) and reconnected

5.9 Thermal Regulation

The MCP73113/4 shall limit the charge current based on the die temperature. The thermal regulation optimizes the charge cycle time while maintaining device reliability. Figure 5-1 depicts the thermal regulation for the MCP73113/4 device. Refer to Section 1.0 “Electrical Characteristics” for thermal package resistances and Section 6.1.1.2 “Thermal Considerations” for calculating power dissipation.



FIGURE 5-1: Charge Current (I_{OUT}) vs. Junction Temperature (T_J).

5.10 Thermal Shutdown

The MCP73113/4 suspends charge if the die temperature exceeds +150°C. Charging will resume when the die temperature has cooled by approximately 10°C. The thermal shutdown is a secondary safety feature in the event that there is a failure within the thermal regulation circuitry.

5.11 Status Indicator

The charge status outputs are open-drain outputs with two different states: Low (L), and High-Impedance (high-Z). The charge status outputs can be used to illuminate LEDs. Optionally, the charge status outputs can be used as an interface to a host microcontroller. Table 5-2 summarizes the state of the status outputs during a charge cycle.

TABLE 5-2: STATUS OUTPUTS

CHARGE CYCLE STATE	STAT
Shutdown	high-Z
Standby	high-Z
Preconditioning	L
Constant Current Fast Charge	L
Constant Voltage	L
Charge Complete - Standby	high-Z
Temperature Fault	1.6 second 50% D.C. Flashing (Type2) high-Z (Type 1)
Timer Fault	1.6 second 50% D.C. Flashing (Type 2) high-Z (Type 1)
Preconditioning Timer Fault	1.6 second 50% D.C. Flashing (Type 2) high-Z (Type 1)

5.12 Battery Short Circuit Protection

When a single-cell Li-Ion battery is detected, an internal battery short circuit protection (BSP) circuit starts monitoring the battery voltage. When V_{BAT} is below the typical 1.7V battery short circuit protection threshold voltage, the charging behavior is postponed. A 25 mA (typical) detection current is supplied for recovering from the battery short circuit condition.

Preconditioning mode resumes when V_{BAT} raises above the battery short circuit protection threshold. The battery voltage must rise approximately 150 mV above the battery short circuit protection voltage before the MCP73113/4 device becomes operational.

MCP73113/4

NOTES:

6.0 APPLICATIONS

The MCP73113/4 devices are designed to operate with a host microcontroller or in stand-alone applications. The MCP73113/4 provides the preferred charge algorithm for Lithium-Ion and Lithium-Polymer cells Constant-current followed by Constant-voltage.

Figure 6-1 depicts a typical stand-alone application circuit, while Figure 6-2 depicts the accompanying charge profile.

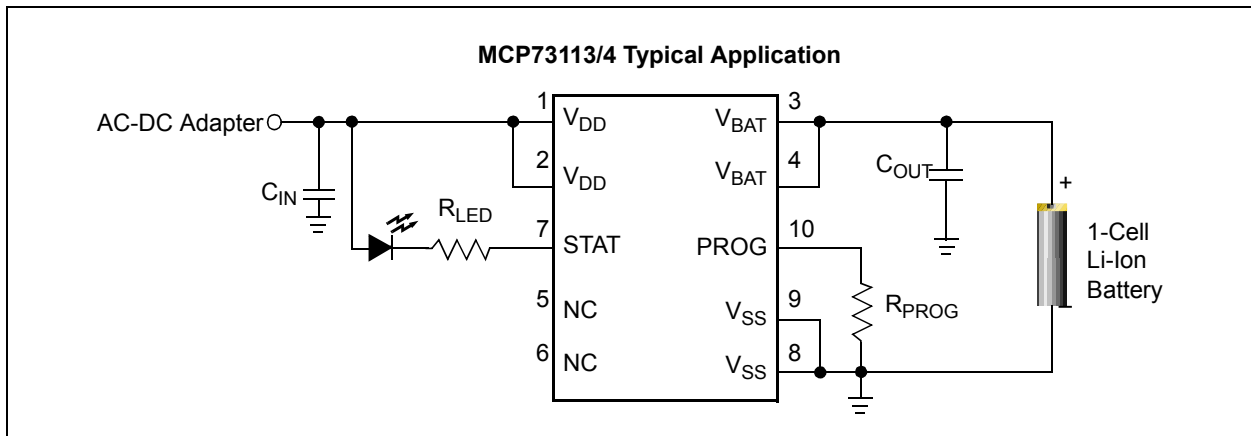

FIGURE 6-1: Typical Application Circuit.

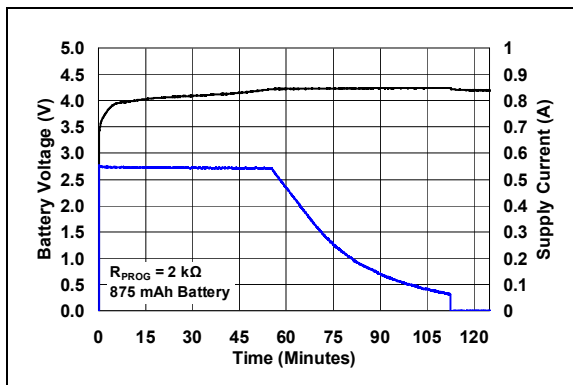

FIGURE 6-2: Typical Charge Profile (875 mAh Battery).

6.1 Application Circuit Design

Due to the low efficiency of linear charging, the most important factors are thermal design and cost, which are a direct function of the input voltage, output current and thermal impedance between the battery charger and the ambient cooling air. The worst-case situation is when the device has transitioned from the Preconditioning mode to the Constant-Current mode. In this situation, the battery charger has to dissipate the maximum power. A trade-off must be made between the charge current, cost and thermal requirements of the charger.

6.1.1 COMPONENT SELECTION

Selection of the external components in Figure 6-1 is crucial to the integrity and reliability of the charging system. The following discussion is intended as a guide for the component selection process.

6.1.1.1 Charge Current

The preferred fast charge current for Li-Ion/Li-Poly cells is below the 1C rate, with an absolute maximum current at the 2C rate. **The recommended fast charge current should be obtained from the battery manufacturer.** For example, a 500 mAh battery pack with 0.7C preferred fast charge current has a charge current of 350 mA. Charging at this rate provides the shortest charge cycle times without degradation to the battery pack performance or life.

Note: Please consult with your battery supplier or refer to the battery data sheet for preferred charge rate.

MCP73113/4

6.1.1.2 Thermal Considerations

The worst-case power dissipation in the battery charger occurs when the input voltage is at the maximum and the device has transitioned from the Preconditioning mode to the Constant-Current mode. In this case, the power dissipation is:

$$PowerDissipation = (V_{DDMAX} - V_{PTHMIN}) \times I_{REGMAX}$$

Where:

- V_{DDMAX} = the maximum input voltage
- I_{REGMAX} = the maximum fast charge current
- V_{PTHMIN} = the minimum transition threshold voltage

Power dissipation with a 5V, $\pm 10\%$ input voltage source, 500 mA $\pm 10\%$ and preconditioning threshold voltage at 2.7V is:

EQUATION 6-1:

$$PowerDissipation = (5.5V - 2.7V) \times 550mA = 1.54W$$

This power dissipation with the battery charger in the DFN-10 package will result approximately 63°C above room temperature.

6.1.1.3 External Capacitors

The MCP73113/4 are stable with or without a battery load. In order to maintain good AC stability in the Constant-Voltage mode, a minimum capacitance of 1 μ F is recommended to bypass the V_{BAT} pin to V_{SS} . This capacitance provides compensation when there is no battery load. In addition, the battery and interconnections appear inductive at high frequencies. These elements are in the control feedback loop during Constant-Voltage mode. Therefore, the bypass capacitance may be necessary to compensate for the inductive nature of the battery pack.

A minimum of 1 μ F, is recommended for both the output capacitor and the input capacitor for typical applications.

TABLE 6-1: MLCC CAPACITOR EXAMPLE

MLCC Capacitors	Temperature Range	Tolerance
X7R	-55°C to +125°C	$\pm 15\%$
X5R	-55°C to +85°C	$\pm 15\%$

Virtually any good quality output filter capacitor can be used, independent of the capacitor's minimum Effective Series Resistance (ESR) value. The actual value of the capacitor (and its associated ESR) depends on the output load current. A 1 μ F ceramic, tantalum or aluminum electrolytic capacitor at the output is usually sufficient to ensure stability.

6.1.1.4 Reverse-Blocking Protection

The MCP73113/4 provide protection from a faulted or shorted input. Without the protection, a faulted or shorted input would discharge the battery pack through the body diode of the internal pass transistor.

6.2 PCB Layout Issues

For optimum voltage regulation, place the battery pack as close as possible to the device's V_{BAT} and V_{SS} pins, recommended to minimize voltage drops along the high current-carrying PCB traces.

If the PCB layout is used as a heat sink, adding many vias in the heat sink pad can help conduct more heat to the backplane of the PCB, thus reducing the maximum junction temperature. Figure 6-4 and Figure 6-5 depict a typical layout with PCB heat sinking.

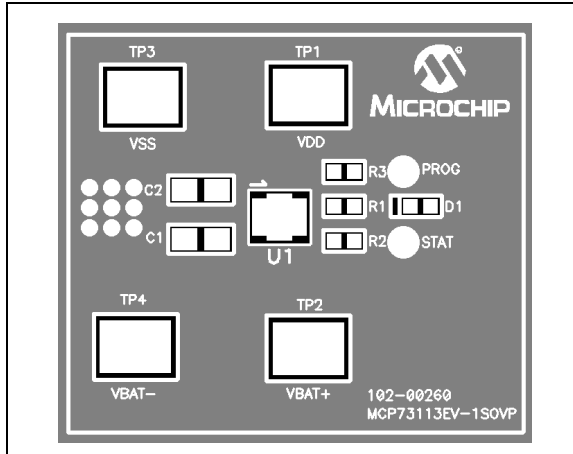

FIGURE 6-3: Typical Layout (Top).

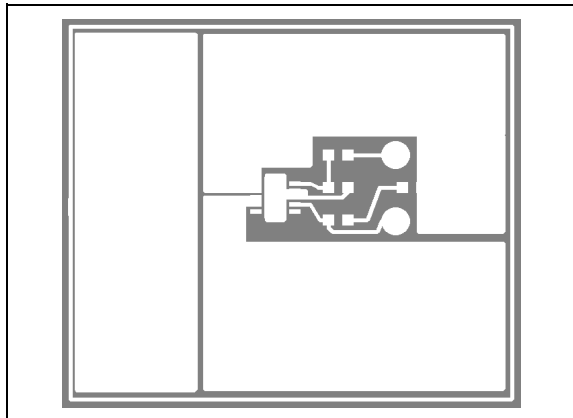

FIGURE 6-4: Typical Layout (Top Metal).



FIGURE 6-5: Typical Layout (Bottom).

MCP73113/4

NOTES:

7.0 PACKAGING INFORMATION

7.1 Package Marking Information

10-Lead DFN (3x3)

XXXX
YYWW
NNN

Standard *	
Part Number	Code
MCP73113-06SI/MF	93HI
MCP73113-16SI/MF	83HI
MCP73114-0NSI/MF	9MHI

Example:

93HI
1229
256

Legend: XX...X Customer-specific information
 Y Year code (last digit of calendar year)
 YY Year code (last 2 digits of calendar year)
 WW Week code (week of January 1 is week '01')
 NNN Alphanumeric traceability code
 (e3) Pb-free JEDEC designator for Matte Tin (Sn)
 * This package is Pb-free. The Pb-free JEDEC designator (e3) can be found on the outer packaging for this package.

Note: In the event the full Microchip part number cannot be marked on one line, it will be carried over to the next line, thus limiting the number of available characters for customer-specific information.

MCP73113/4

10-Lead Plastic Dual Flat, No Lead Package (MF) - 3x3x0.9mm Body [DFN]

Note: For the most current package drawings, please see the Microchip Packaging Specification located at <http://www.microchip.com/packaging>



Microchip Technology Drawing No. C04-063C Sheet 1 of 2

10-Lead Plastic Dual Flat, No Lead Package (MF) - 3x3x0.9mm Body [DFN]

Note: For the most current package drawings, please see the Microchip Packaging Specification located at <http://www.microchip.com/packaging>



Dimension Limits	Units	MILLIMETERS		
		MIN	NOM	MAX
Number of Pins	N	10		
Pitch	e	0.50 BSC		
Overall Height	A	0.80	0.90	1.00
Standoff	A1	0.00	0.02	0.05
Contact Thickness	A3	0.20 REF		
Overall Length	D	3.00 BSC		
Exposed Pad Length	D2	2.15	2.35	2.45
Overall Width	E	3.00 BSC		
Exposed Pad Width	E2	1.40	1.50	1.75
Contact Width	b	0.18	0.25	0.30
Contact Length	L	0.30	0.40	0.50
Contact-to-Exposed Pad	K	0.20	-	-

Notes:

1. Pin 1 visual index feature may vary, but must be located within the hatched area.
2. Package may have one or more exposed tie bars at ends.
3. Package is saw singulated.
4. Dimensioning and tolerancing per ASME Y14.5M.
 BSC: Basic Dimension. Theoretically exact value shown without tolerances.
 REF: Reference Dimension, usually without tolerance, for information purposes only.

Microchip Technology Drawing No. C04-063C Sheet 2 of 2

MCP73113/4

10-Lead Plastic Dual Flat, No Lead Package (MF) - 3x3x0.9mm Body [DFN]

Note: For the most current package drawings, please see the Microchip Packaging Specification located at <http://www.microchip.com/packaging>

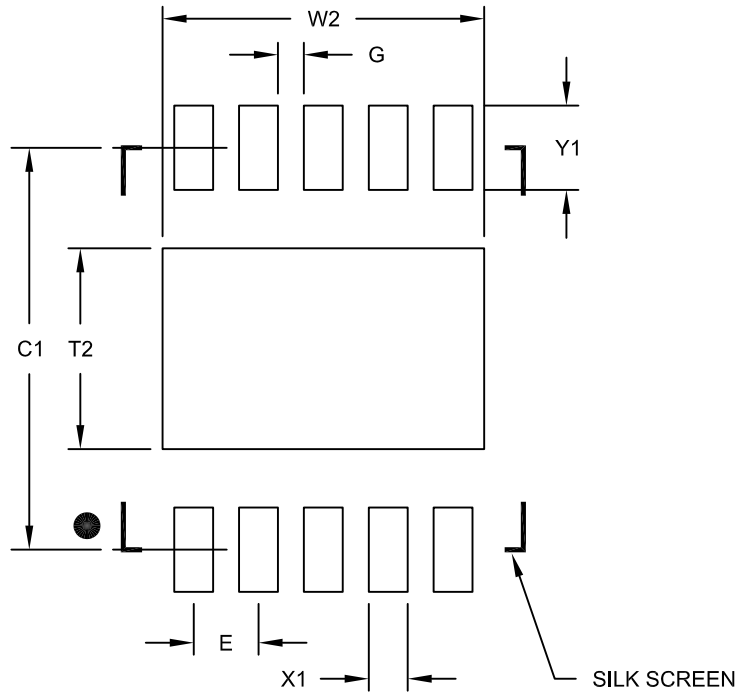

RECOMMENDED LAND PATTERN

		Units	MILLIMETERS		
Dimension Limits			MIN	NOM	MAX
Contact Pitch	E		0.50 BSC		
Optional Center Pad Width	W2				2.48
Optional Center Pad Length	T2				1.55
Contact Pad Spacing	C1			3.10	
Contact Pad Width (X10)	X1				0.30
Contact Pad Length (X10)	Y1				0.65
Distance Between Pads	G	0.20			

Notes:

1. Dimensioning and tolerancing per ASME Y14.5M

BSC: Basic Dimension. Theoretically exact value shown without tolerances.

Microchip Technology Drawing No. C04-2063B

APPENDIX A: REVISION HISTORY

Revision D (February 2013)

The following is the list of modifications:

1. Updated the Functional Block Diagram.
2. Updated the DC Characteristics table.
3. Updated the Temperature Specifications table.
4. Updated **Section 3.6 “Current Regulation Set (PROG)”**.
5. Updated **Section 3.7 “Exposed Pad (EP)”**.
6. Updated **Section 5.3.3 “Battery Detection”**.
7. Updated [Equation 5-2](#).
8. Updated **Section 5.12 “Battery Short Circuit Protection”**.
9. Updated **Section 6.1.1.3 “External Capacitors”**.

Revision C (January 2010)

The following is the list of modifications:

1. **DC Characteristics table:** Removed the minimum and maximum values for the BSP Start Threshold parameter.

Revision B (July 2009)

The following is the list of modifications:

1. Added MCP73114 device throughout the document.
2. Updated specifications for the MCP73113/4 device family throughout the document.
3. Updated package marking information.
4. Updated Product Identification System page.

Revision A (May 2009)

- Original Release of this Document.

MCP73113/4

NOTES:

PRODUCT IDENTIFICATION SYSTEM

To order or obtain information, e.g., on pricing or delivery, refer to the factory or the listed sales office.

<u>PART NO.</u>	<u>X</u>	<u>XX</u>
Device	Temperature Range	Package
<p>Device:</p> <p>MCP73113: Single Cell Li-Ion/Li-Polymer Battery Device MCP73113T: Single Cell Li-Ion/Li-Polymer Battery Device, Tape and Reel</p> <p>MCP73114: Single Cell Li-Ion/Li-Polymer Battery Device MCP73114T: Single Cell Li-Ion/Li-Polymer Battery Device, Tape and Reel</p> <p>Temperature Range:</p> <p>I = -40°C to +85°C (Industrial)</p> <p>Package:</p> <p>MF = Plastic Dual Flat No Lead, 3x3 mm Body (DFN), 10-Lead</p>		<p>Examples:</p> <p>a) MCP73113-06SI/MF: Single Cell Li-Ion/Li-Polymer Battery Device</p> <p>b) MCP73113-16SI/MF: Single Cell Li-Ion/Li-Polymer Battery Device</p> <p>c) MCP73113T-06SI-MF: Tape and Reel, Single Cell Li-Ion/Li-Polymer Battery Device</p> <p>d) MCP73113T-16SI/MF: Tape and Reel, Single Cell Li-Ion/Li-Polymer Battery Device</p> <p>a) MCP73114-0NSI/MF: Single Cell Li-Ion/Li-Polymer Battery Device</p> <p>b) MCP73114T-0NSI/MF: Tape and Reel, Single Cell Li-Ion/Li-Polymer Battery Device</p>

MCP73113/4

NOTES:

Note the following details of the code protection feature on Microchip devices:

- Microchip products meet the specification contained in their particular Microchip Data Sheet.
- Microchip believes that its family of products is one of the most secure families of its kind on the market today, when used in the intended manner and under normal conditions.
- There are dishonest and possibly illegal methods used to breach the code protection feature. All of these methods, to our knowledge, require using the Microchip products in a manner outside the operating specifications contained in Microchip's Data Sheets. Most likely, the person doing so is engaged in theft of intellectual property.
- Microchip is willing to work with the customer who is concerned about the integrity of their code.
- Neither Microchip nor any other semiconductor manufacturer can guarantee the security of their code. Code protection does not mean that we are guaranteeing the product as “unbreakable.”

Code protection is constantly evolving. We at Microchip are committed to continuously improving the code protection features of our products. Attempts to break Microchip's code protection feature may be a violation of the Digital Millennium Copyright Act. If such acts allow unauthorized access to your software or other copyrighted work, you may have a right to sue for relief under that Act.

Information contained in this publication regarding device applications and the like is provided only for your convenience and may be superseded by updates. It is your responsibility to ensure that your application meets with your specifications. MICROCHIP MAKES NO REPRESENTATIONS OR WARRANTIES OF ANY KIND WHETHER EXPRESS OR IMPLIED, WRITTEN OR ORAL, STATUTORY OR OTHERWISE, RELATED TO THE INFORMATION, INCLUDING BUT NOT LIMITED TO ITS CONDITION, QUALITY, PERFORMANCE, MERCHANTABILITY OR FITNESS FOR PURPOSE. Microchip disclaims all liability arising from this information and its use. Use of Microchip devices in life support and/or safety applications is entirely at the buyer's risk, and the buyer agrees to defend, indemnify and hold harmless Microchip from any and all damages, claims, suits, or expenses resulting from such use. No licenses are conveyed, implicitly or otherwise, under any Microchip intellectual property rights.

Trademarks

The Microchip name and logo, the Microchip logo, dsPIC, FlashFlex, KEELOQ, KEELOQ logo, MPLAB, PIC, PICmicro, PICSTART, PIC³² logo, rPIC, SST, SST Logo, SuperFlash and UNI/O are registered trademarks of Microchip Technology Incorporated in the U.S.A. and other countries.

FilterLab, Hampshire, HI-TECH C, Linear Active Thermistor, MTP, SEEVAL and The Embedded Control Solutions Company are registered trademarks of Microchip Technology Incorporated in the U.S.A.

Silicon Storage Technology is a registered trademark of Microchip Technology Inc. in other countries.

Analog-for-the-Digital Age, Application Maestro, BodyCom, chipKIT, chipKIT logo, CodeGuard, dsPICDEM, dsPICDEM.net, dsPICworks, dsSPEAK, ECAN, ECONOMONITOR, FanSense, HI-TIDE, In-Circuit Serial Programming, ICSP, Mindi, MiWi, MPASM, MPF, MPLAB Certified logo, MPLIB, MPLINK, mTouch, Omniclient Code Generation, PICC, PICC-18, PICDEM, PICDEM.net, PICkit, PICTail, REAL ICE, rLAB, Select Mode, SQI, Serial Quad I/O, Total Endurance, TSHARC, UniWinDriver, WiperLock, ZENA and Z-Scale are trademarks of Microchip Technology Incorporated in the U.S.A. and other countries.

SQTP is a service mark of Microchip Technology Incorporated in the U.S.A.

GestIC and ULPP are registered trademarks of Microchip Technology Germany II GmbH & Co. & KG, a subsidiary of Microchip Technology Inc., in other countries.

All other trademarks mentioned herein are property of their respective companies.

© 2009-2013, Microchip Technology Incorporated, Printed in the U.S.A., All Rights Reserved.

 Printed on recycled paper.

ISBN: 9781620769959

QUALITY MANAGEMENT SYSTEM
CERTIFIED BY DNV
== ISO/TS 16949 ==

Microchip received ISO/TS-16949:2009 certification for its worldwide headquarters, design and wafer fabrication facilities in Chandler and Tempe, Arizona; Gresham, Oregon and design centers in California and India. The Company's quality system processes and procedures are for its PIC[®] MCUs and dsPIC[®] DSCs, KEELOQ[®] code hopping devices, Serial EEPROMs, microperipherals, nonvolatile memory and analog products. In addition, Microchip's quality system for the design and manufacture of development systems is ISO 9001:2000 certified.



MICROCHIP

Worldwide Sales and Service

AMERICAS

Corporate Office
2355 West Chandler Blvd.
Chandler, AZ 85224-6199
Tel: 480-792-7200
Fax: 480-792-7277
Technical Support:
<http://www.microchip.com/support>
Web Address:
www.microchip.com

Atlanta
Duluth, GA
Tel: 678-957-9614
Fax: 678-957-1455

Boston
Westborough, MA
Tel: 774-760-0087
Fax: 774-760-0088

Chicago
Itasca, IL
Tel: 630-285-0071
Fax: 630-285-0075

Cleveland
Independence, OH
Tel: 216-447-0464
Fax: 216-447-0643

Dallas
Addison, TX
Tel: 972-818-7423
Fax: 972-818-2924

Detroit
Farmington Hills, MI
Tel: 248-538-2250
Fax: 248-538-2260

Indianapolis
Noblesville, IN
Tel: 317-773-8323
Fax: 317-773-5453

Los Angeles
Mission Viejo, CA
Tel: 949-462-9523
Fax: 949-462-9608

Santa Clara
Santa Clara, CA
Tel: 408-961-6444
Fax: 408-961-6445

Toronto
Mississauga, Ontario,
Canada
Tel: 905-673-0699
Fax: 905-673-6509

ASIA/PACIFIC

Asia Pacific Office
Suites 3707-14, 37th Floor
Tower 6, The Gateway
Harbour City, Kowloon
Hong Kong
Tel: 852-2401-1200
Fax: 852-2401-3431

Australia - Sydney
Tel: 61-2-9868-6733
Fax: 61-2-9868-6755

China - Beijing
Tel: 86-10-8569-7000
Fax: 86-10-8528-2104

China - Chengdu
Tel: 86-28-8665-5511
Fax: 86-28-8665-7889

China - Chongqing
Tel: 86-23-8980-9588
Fax: 86-23-8980-9500

China - Hangzhou
Tel: 86-571-2819-3187
Fax: 86-571-2819-3189

China - Hong Kong SAR
Tel: 852-2943-5100
Fax: 852-2401-3431

China - Nanjing
Tel: 86-25-8473-2460
Fax: 86-25-8473-2470

China - Qingdao
Tel: 86-532-8502-7355
Fax: 86-532-8502-7205

China - Shanghai
Tel: 86-21-5407-5533
Fax: 86-21-5407-5066

China - Shenyang
Tel: 86-24-2334-2829
Fax: 86-24-2334-2393

China - Shenzhen
Tel: 86-755-8864-2200
Fax: 86-755-8203-1760

China - Wuhan
Tel: 86-27-5980-5300
Fax: 86-27-5980-5118

China - Xian
Tel: 86-29-8833-7252
Fax: 86-29-8833-7256

China - Xiamen
Tel: 86-592-2388138
Fax: 86-592-2388130

China - Zhuhai
Tel: 86-756-3210040
Fax: 86-756-3210049

ASIA/PACIFIC

India - Bangalore
Tel: 91-80-3090-4444
Fax: 91-80-3090-4123

India - New Delhi
Tel: 91-11-4160-8631
Fax: 91-11-4160-8632

India - Pune
Tel: 91-20-2566-1512
Fax: 91-20-2566-1513

Japan - Osaka
Tel: 81-6-6152-7160
Fax: 81-6-6152-9310

Japan - Tokyo
Tel: 81-3-6880-3770
Fax: 81-3-6880-3771

Korea - Daegu
Tel: 82-53-744-4301
Fax: 82-53-744-4302

Korea - Seoul
Tel: 82-2-554-7200
Fax: 82-2-558-5932 or
82-2-558-5934

Malaysia - Kuala Lumpur
Tel: 60-3-6201-9857
Fax: 60-3-6201-9859

Malaysia - Penang
Tel: 60-4-227-8870
Fax: 60-4-227-4068

Philippines - Manila
Tel: 63-2-634-9065
Fax: 63-2-634-9069

Singapore
Tel: 65-6334-8870
Fax: 65-6334-8850

Taiwan - Hsin Chu
Tel: 886-3-5778-366
Fax: 886-3-5770-955

Taiwan - Kaohsiung
Tel: 886-7-213-7828
Fax: 886-7-330-9305

Taiwan - Taipei
Tel: 886-2-2508-8600
Fax: 886-2-2508-0102

Thailand - Bangkok
Tel: 66-2-694-1351
Fax: 66-2-694-1350

EUROPE

Austria - Wels
Tel: 43-7242-2244-39
Fax: 43-7242-2244-393

Denmark - Copenhagen
Tel: 45-4450-2828
Fax: 45-4485-2829

France - Paris
Tel: 33-1-69-53-63-20
Fax: 33-1-69-30-90-79

Germany - Munich
Tel: 49-89-627-144-0
Fax: 49-89-627-144-44

Italy - Milan
Tel: 39-0331-742611
Fax: 39-0331-466781

Netherlands - Drunen
Tel: 31-416-690399
Fax: 31-416-690340

Spain - Madrid
Tel: 34-91-708-08-90
Fax: 34-91-708-08-91

UK - Wokingham
Tel: 44-118-921-5869
Fax: 44-118-921-5820

11/29/12

Компания «Океан Электроники» предлагает заключение долгосрочных отношений при поставках импортных электронных компонентов на взаимовыгодных условиях!

Наши преимущества:

- Поставка оригинальных импортных электронных компонентов напрямую с производств Америки, Европы и Азии, а так же с крупнейших складов мира;
- Широкая линейка поставок активных и пассивных импортных электронных компонентов (более 30 млн. наименований);
- Поставка сложных, дефицитных, либо снятых с производства позиций;
- Оперативные сроки поставки под заказ (от 5 рабочих дней);
- Экспресс доставка в любую точку России;
- Помощь Конструкторского Отдела и консультации квалифицированных инженеров;
- Техническая поддержка проекта, помощь в подборе аналогов, поставка прототипов;
- Поставка электронных компонентов под контролем ВП;
- Система менеджмента качества сертифицирована по Международному стандарту ISO 9001;
- При необходимости вся продукция военного и аэрокосмического назначения проходит испытания и сертификацию в лаборатории (по согласованию с заказчиком);
- Поставка специализированных компонентов военного и аэрокосмического уровня качества (Xilinx, Altera, Analog Devices, Intersil, Interpoint, Microsemi, Actel, Aeroflex, Peregrine, VPT, Syfer, Eurofarad, Texas Instruments, MS Kennedy, Miteq, Cobham, E2V, MA-COM, Hittite, Mini-Circuits, General Dynamics и др.);

Компания «Океан Электроники» является официальным дистрибьютором и эксклюзивным представителем в России одного из крупнейших производителей разъемов военного и аэрокосмического назначения «JONHON», а так же официальным дистрибьютором и эксклюзивным представителем в России производителя высокотехнологичных и надежных решений для передачи СВЧ сигналов «FORSTAR».



JONHON

«JONHON» (основан в 1970 г.)

Разъемы специального, военного и аэрокосмического назначения:

(Применяются в военной, авиационной, аэрокосмической, морской, железнодорожной, горно- и нефтедобывающей отраслях промышленности)

«FORSTAR» (основан в 1998 г.)

ВЧ соединители, коаксиальные кабели, кабельные сборки и микроволновые компоненты:

(Применяются в телекоммуникациях гражданского и специального назначения, в средствах связи, РЛС, а так же военной, авиационной и аэрокосмической отраслях промышленности).



Телефон: 8 (812) 309-75-97 (многоканальный)

Факс: 8 (812) 320-03-32

Электронная почта: ocean@oceanchips.ru

Web: <http://oceanchips.ru/>

Адрес: 198099, г. Санкт-Петербург, ул. Калинина, д. 2, корп. 4, лит. А