

## Ceramic Disc Capacitors, Class 1, Class 2, Low Loss (0.2 %), 500 V<sub>DC</sub>, 1 kV<sub>DC</sub>, 2 kV<sub>DC</sub>, and 3 kV<sub>DC</sub>

**FEATURES**

- High reliability
- Low losses
- High capacitance in small size
- Kinked leads
- Material categorization:  
for definitions of compliance please see  
[www.vishay.com/doc?99912](http://www.vishay.com/doc?99912)

**RoHS  
COMPLIANT**
**APPLICATIONS**

In electronic circuits where low losses and high capacitance per volume are essential, for example:

- SMPS
- HF ballast
- Snubber and high voltage circuits

QUICK REFERENCE DATA							
DESCRIPTION	VALUE						
Ceramic Class	1			2			
Ceramic Dielectric	S3N			Y5R			
Voltage (V <sub>DC</sub> )	1000	2000	3000	500	1000	2000	3000
Min. Capacitance (pF)	100	100	100	100	100	100	100
Max. Capacitance (pF)	2200	4700	2700	2700	4700	4700	2700
Mounting	Radial						

**MARKING**

Marking indicates capacitance value and tolerance in accordance with “EIA 198” and voltage marks.

**OPERATING TEMPERATURE RANGE**

-30 °C to +125 °C

**TEMPERATURE CHARACTERISTICS**

Class 1: S3N

Class 2: Y5R

**SECTIONAL SPECIFICATION**

IEC 60384-9, EIA 198

**EXAMPLES OF MARKING CODE**

Disc size (D <sub>max.</sub> ) ≤ 6.5 mm:	Disc size (D <sub>max.</sub> ) ≥ 7.5 mm:
	BC
RR = low loss with T.C. Y5R	RR
101K	102K
2 kV	3 kV

**Note**

- Remark: no TC marking for S3N

**AGING**

Typical 0.5 % per time decade

**Note**

- The capacitors meet the essential requirements of “IEC 60384-9 and EIA 198”. Unless stated otherwise all electrical values apply at an ambient temperature of 25 °C ± 3 °C, at normal atmospheric conditions

**DESIGN**

The capacitors consist of a ceramic disc both sides of which are silver-plated. Connection leads are made of tinned copper having a diameter of 0.6 mm or 0.8 mm.

The capacitors are supplied with kinked leads and lead spacings of 5 mm or 7.5 mm and 10 mm. Encapsulation is made of epoxy-resin, flammable resistant in accordance with “UL 94 V-0”

**CAPACITANCE RANGE**

100 pF to 4700 pF

**RATED DC VOLTAGE**

500 V; 1 kV; 2 kV; 3 kV

**DIELECTRIC STRENGTH**

200 % of rated voltage

**INSULATION RESISTANCE AT 500 V<sub>DC</sub>**

≥ 10 000 MΩ min.

**TOLERANCE ON CAPACITANCE**

± 10 %; ± 20 %

**DISSIPATION FACTOR**

0.2 % max.



ORDERING CODES

DIELECTRIC S3N (1000 V <sub>DC</sub> / 2000 V <sub>DC</sub> )						
CAP. (pF)	1000 V <sub>DC</sub>			2000 V <sub>DC</sub>		
	ORDERING CODE	DIAMETER (mm max.)	THICKNESS (mm max.)	ORDERING CODE	DIAMETER (mm max.)	THICKNESS (mm max.)
100	F101K25S3NN6###R	6.5	4.0	F101K25S3NP6###R	6.5	4.5
120	F121K25S3NN6###R	6.5	4.0	F121K25S3NP6###R	6.5	4.5
150	F151K25S3NN6###R	6.5	4.0	F151K25S3NP6###R	6.5	4.5
180	F181K25S3NN6###R	6.5	4.0	F181K25S3NP6###R	6.5	4.5
220	F221K25S3NN6###R	6.5	4.0	F221K25S3NP6###R	6.5	4.5
270	F271K25S3NN6###R	6.5	4.0	F271K25S3NP6###R	6.5	4.5
330	F331K25S3NN6###R	6.5	4.0	F331K29S3NP6###R	7.5	4.5
390	F391K25S3NN6###R	6.5	4.0	F391K29S3NP6###R	7.5	4.5
470	F471K25S3NN6###R	6.5	4.0	F471K33S3NP6###R	8.5	4.5
560	F561K29S3NN6###R	7.5	4.0	F561K39S3NP6###R	10.0	4.5
680	F681K29S3NN6###R	7.5	4.0	F681K39S3NP6###R	10.0	4.5
820	F821K33S3NN6###R	8.5	4.0	F821K39S3NP6###R	10.0	4.5
1000	F102K33S3NN6###R	8.5	4.0	F102K43S3NP6###R	11.0	4.5
1200	F122K39S3NN6###R	10.0	4.0	F122K47S3NP63K7R	12.0	4.5
1500	F152K39S3NN6###R	10.0	4.0	F152K53S3NP63K7R	13.5	4.5
1800	F182K43S3NN6###R	11.0	4.0	F182K53S3NP63K7R	13.5	4.5
2200	F222K47S3NN6###R	12.0	4.0	F222K63S3NP63K7R	16.0	4.5
2700	/	/	/	F272K63S3NP63K7R	16.0	4.5
3300	/	/	/	F332K69S3NP63K7R	17.5	4.5
3900	/	/	/	F392K75S3NP83K0R	19.0	4.5
4700	/	/	/	F472K84S3NP83K0R	21.5	4.5

DIELECTRIC S3N (3000 V <sub>DC</sub> )			
CAP. (pF)	3000 V <sub>DC</sub>		
	ORDERING CODE	DIAMETER (mm max.)	THICKNESS (mm max.)
100	F101K25S3NR6###R	6.5	5.5
120	F121K25S3NR6###R	6.5	5.5
150	F151K29S3NR6###R	7.5	5.5
180	F181K29S3NR6###R	7.5	5.5
220	F221K29S3NR6###R	7.5	5.5
270	F271K29S3NR6###R	7.5	5.5
330	F331K33S3NR6###R	8.5	5.5
390	F391K39S3NR6###R	10.0	5.5
470	F471K39S3NR6###R	10.0	5.5
560	F561K39S3NR6###R	10.0	5.5
680	F681K43S3NR6###R	11.0	5.5
820	F821K53S3NR6###R	13.5	5.5
1000	F102K53S3NR6###R	13.5	5.5
1200	F122K59S3NR6###R	15.0	5.5
1500	F152K63S3NR6###R	16.0	5.5
1800	F182K69S3NR6###R	17.5	5.5
2200	F222K75S3NR83K0R	19.0	5.5
2700	F272K75S3NR83K0R	19.0	5.5

Notes

- Lead diameter is 0.6 mm
- # 5<sup>th</sup> digit is capacitance tolerance code: ± 10 % = K; ± 20 % = M
- # 13<sup>th</sup> digit is packaging code: bulk = 3; reel = T; ammo = U
- # 14<sup>th</sup> digit is lead style code: L; J; K (J is valid for 1 kV only)
- # 15<sup>th</sup> digit is lead spacing code: 5.0 mm = 5; 6.4 mm = 6; 7.5 mm = 7; 10.0 mm = 0



DIELECTRIC Y5R (500 V <sub>DC</sub> / 1000 V <sub>DC</sub> )						
CAP. (pF)	500 V <sub>DC</sub>			1000 V <sub>DC</sub>		
	ORDERING CODE	DIAMETER (mm max.)	THICKNESS (mm max.)	ORDERING CODE	DIAMETER (mm max.)	THICKNESS (mm max.)
100	F101K20Y5RL6###R	5.0	3.5	F101K25Y5RN6###R	6.5	4.0
120	F121K20Y5RL6###R	5.0	3.5	F121K25Y5RN6###R	6.5	4.0
150	F151K20Y5RL6###R	5.0	3.5	F151K25Y5RN6###R	6.5	4.0
180	F181K20Y5RL6###R	5.0	3.5	F181K25Y5RN6###R	6.5	4.0
220	F221K20Y5RL6###R	5.0	3.5	F221K25Y5RN6###R	6.5	4.0
270	F271K20Y5RL6###R	5.0	3.5	F271K29Y5RN6###R	7.5	4.0
330	F331K20Y5RL6###R	5.0	3.5	F331K29Y5RN6###R	7.5	4.0
390	F391K25Y5RL6###R	6.5	3.5	F391K29Y5RN6###R	7.5	4.0
470	F471K25Y5RL6###R	6.5	3.5	F471K29Y5RN6###R	7.5	4.0
560	F561K25Y5RL6###R	6.5	3.5	F561K33Y5RN6###R	8.5	4.0
680	F681K25Y5RL6###R	6.5	3.5	F681K33Y5RN6###R	8.5	4.0
820	F821K29Y5RL6###R	7.5	3.5	F821K39Y5RN6###R	10.0	4.0
1000	F102K29Y5RL6###R	7.5	3.5	F102K39Y5RN6###R	10.0	4.0
1200	F122K33Y5RL6###R	8.5	3.5	F122K43Y5RN6###R	11.0	4.0
1500	F152K33Y5RL6###R	8.5	3.5	F152K43Y5RN6###R	11.0	4.0
1800	F182K39Y5RL6###R	10.0	3.5	F182K47Y5RN6###R	12.0	4.0
2200	F222K43Y5RL63J7R	11.0	3.5	F222K53Y5RN6###R	13.5	4.0
2700	F272K47Y5RL63J7R	12.0	3.5	F272K53Y5RN6###R	13.5	4.0
3300	/	/	/	F332K69Y5RN6###R	17.5	4.0
3900	/	/	/	F392K69Y5RN83K0R	17.5	4.0
4700	/	/	/	F472K75Y5RN83K0R	19.0	4.0

DIELECTRIC Y5R (2000 V <sub>DC</sub> / 3000 V <sub>DC</sub> )						
CAP. (pF)	2000 V <sub>DC</sub>			3000 V <sub>DC</sub>		
	ORDERING CODE	DIAMETER (mm max.)	THICKNESS (mm max.)	ORDERING CODE	DIAMETER (mm max.)	THICKNESS (mm max.)
100	F101K25Y5RP6###R	6.5	5.0	F101K33Y5RR6###R	8.5	5.5
120	F121K25Y5RP6###R	6.5	5.0	F121K33Y5RR6###R	8.5	5.5
150	F151K25Y5RP6###R	6.5	5.0	F151K33Y5RR6###R	8.5	5.5
180	F181K29Y5RP6###R	7.5	5.0	F181K33Y5RR6###R	8.5	5.5
220	F221K29Y5RP6###R	7.5	5.0	F221K33Y5RR6###R	8.5	5.5
270	F271K29Y5RP6###R	7.5	5.0	F271K33Y5RR6###R	8.5	5.5
330	F331K29Y5RP6###R	7.5	5.0	F331K33Y5RR6###R	8.5	5.5
390	F391K33Y5RP6###R	8.5	5.0	F391K39Y5RR6###R	10.0	5.5
470	F471K33Y5RP6###R	8.5	5.0	F471K39Y5RR6###R	10.0	5.5
560	F561K39Y5RP6###R	10.0	5.0	F561K43Y5RR6###R	11.0	5.5
680	F681K39Y5RP6###R	10.0	5.0	F681K43Y5RR6###R	11.0	5.5
820	F821K43Y5RP6###R	11.0	5.0	F821K53Y5RR6###R	13.5	5.5
1000	F102K43Y5RP6###R	11.0	5.0	F102K53Y5RR6###R	13.5	5.5
1200	F122K47Y5RP6###R	12.0	5.0	F122K59Y5RR6###R	15.0	5.5
1500	F152K53Y5RP6###R	13.5	5.0	F152K59Y5RR6###R	15.0	5.5
1800	F182K59Y5RP6###R	15.0	5.0	F182K75Y5RR6###R	19.0	5.5
2200	F222K69Y5RP83K0R	17.5	5.0	F222K75Y5RR83K0R	19.0	5.5
2700	F272K75Y5RP83K0R	19.0	5.0	F272K84Y5RR83K0R	21.0	5.5
3300	F332K75Y5RP83K0R	19.0	5.0	/	/	/
3900	F392K75Y5RP83K0R	19.0	5.0	/	/	/
4700	F472K96Y5RP83K0R	24.5	5.0	/	/	/

Notes

- Lead diameter is 0.6 mm
- # 5<sup>th</sup> digit is capacitance tolerance code: ± 10 % = K; ± 20 % = M
- # 13<sup>th</sup> digit is packaging code: bulk = 3; reel = T; ammo = U
- # 14<sup>th</sup> digit is lead style code: L; J; K (J is valid for 1 kV only)
- # 15<sup>th</sup> digit is lead spacing code: 5.0 mm = 5; 6.4 mm = 6; 7.5 mm = 7; 10.0 mm = 0

PACKAGING					
PACKAGING TYPE	SIZE CODE	LEAD SPACE (mm)	VOLTAGE (V <sub>DC</sub> )	SPQ	BOX DIMENSIONS L x W x H
Bulk (long lead L ≥ 25.4 mm)	20 to 25	all	all	1000	245 x 120 x 65
	29 to 39			1000	
	43 to 47			1000	
	53 to 75			500	
	84 to 96			250	
Tape and reel	≤ 47	≤ 6.4	< 500	2500	370 x 370 x 60
			500 ≤ WV ≤ 2000	2000	
			3000	1000	
	≥ 7.5	all	1000		
≥ 53	all	all	1000		
Ammopack	≤ 47	≤ 6.4	< 500	2000	335 x 240 x 50
			500 ≤ WV < 2000	2000	335 x 290 x 50
			2000 and 3000	1500	360 x 330 x 55
	≥ 7.5	all	1500	360 x 330 x 55	
	≥ 53	all	all	1500	335 x 290 x 50

**Note**

- The capacitors are supplied in bulk packaging (cardboard boxes), in tape on reel or in ammpack

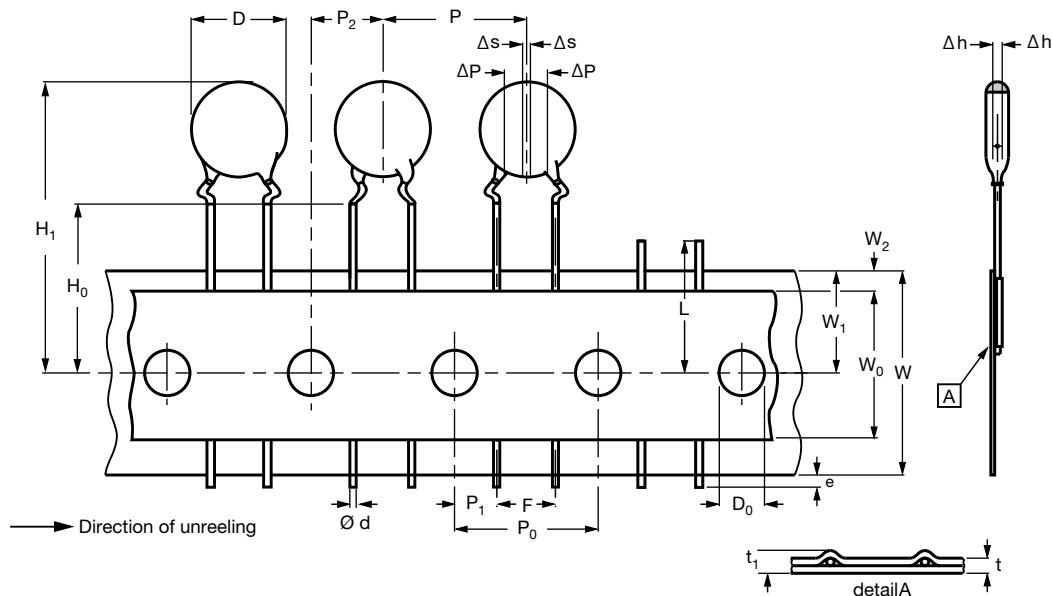

Kinked capacitors on tape, lead spacing 5.0 mm (0.2) or 7.5 mm (0.3)

DIMENSIONS OF TAPE			
SYMBOL	PARAMETER	DIMENSIONS (mm)	
		FEED-HOLE PITCH $P_0 = 12.7$	FEED-HOLE PITCH $P_0 = 15.0$
D	Body diameter	11.0 max.	14.0 max.
d	Lead diameter	$0.6 \pm 0.05$	$0.6 \pm 0.05$
P <sup>(1)</sup>	Pitch between capacitors	$12.7 \pm 1.0$	$15.0 \pm 1.0$
$P_0$	Feed-hole pitch	$12.7 \pm 0.3$	$15.0 \pm 0.3$
$\Delta P$	Plane deviation	1.0 max.	1.0 max.
P <sub>1</sub> <sup>(2)</sup>	Feed-hole center to lead center	$3.85 \pm 0.7$	$3.75 \pm 0.7$
P <sub>2</sub> <sup>(2)</sup>	Feed-hole center to component center	$6.35 \pm 1.3$	$7.5 \pm 1.5$
F	Lead spacing	$5.0 + 0.6/- 0.4$	$7.5 + 0.6/- 0.4$
$\Delta h$	Component alignment	$0 \pm 1.0$	$0 \pm 1.0$
W	Tape width	$18.0 + 1.0/- 0.5$	$18.0 + 1.0/- 0.5$
W <sub>0</sub>	Hold-down tape width	5.0 min.	5.0 min.
W <sub>1</sub>	Hole position	$9.0 + 0.75/- 0.5$	$9.0 + 0.75/- 0.5$
W <sub>2</sub>	Hold-down tape margin	3.0 max.	3.0 max.
H <sub>0</sub>	Height to seating plane	$16.0 \pm 0.5$	$16.0 \pm 0.5$
H <sub>1</sub>	Maximum component height	32.0	40.0
e	Lead end protrusion	1.0 max.	1.0 max.
L	Maximum length of snapped lead	11.0	11.0
D <sub>0</sub>	Feed-hole diameter	$4.0 \pm 0.2$	$4.0 \pm 0.2$
t	Total tape thickness	0.9 max.	0.9 max.
t <sub>1</sub>	Maximum thickness of tape and wires	1.5 max.	1.5 max.

**Notes**

 (1) Cumulative pitch error:  $\pm \leq 1$  mm/20 pitches

(2) Obliquity maximum 3°

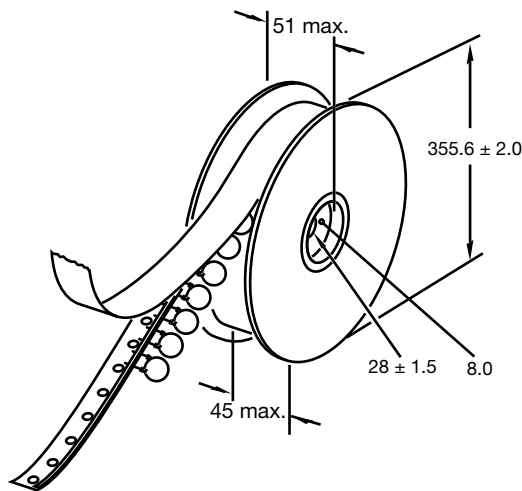
**REEL AND TAPE DATA** in millimeters

Reel with capacitors on tape

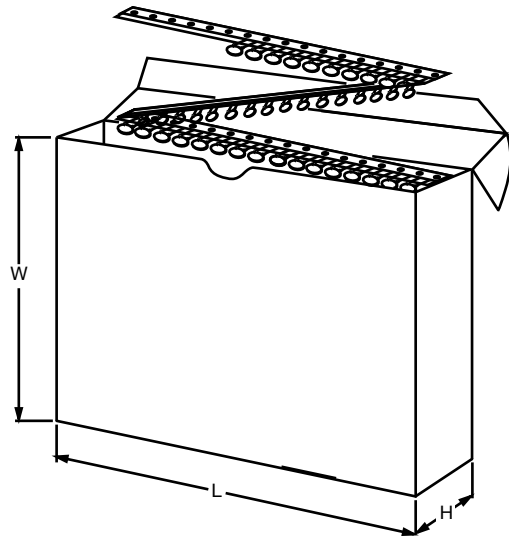

Ammpack with capacitors on tape

DIMENSIONS OF AMMOPACK			
PARAMETER	DISC SIZE (D <sub>MAX.</sub> )		UNIT
	6.5 mm to 11.0 mm	12.0 mm to 13.5 mm	
Taping pitch	12.7	15.0	mm
L	335	360	mm
W	290	330	mm
H	50	55	mm

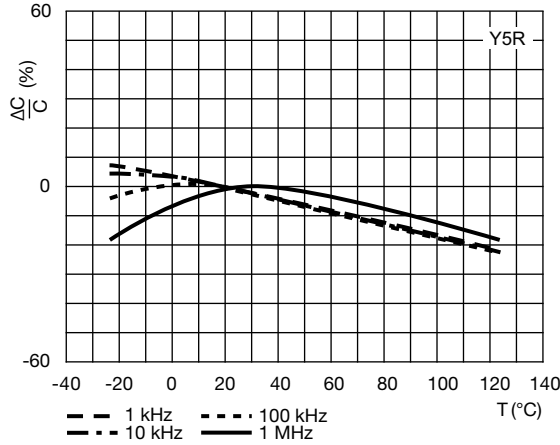

Typical capacitance change as a function of temperature and frequency

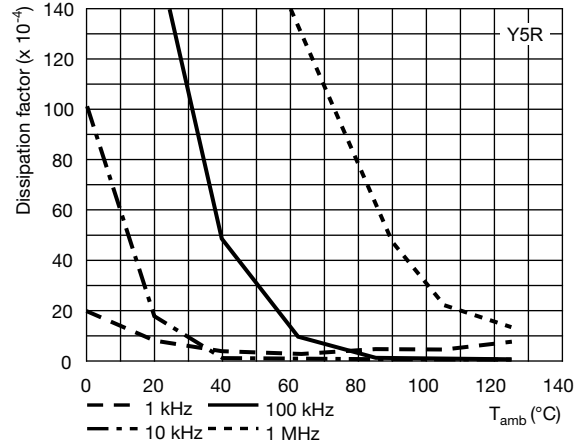

Typical dissipation factor as a function of temperature and frequency

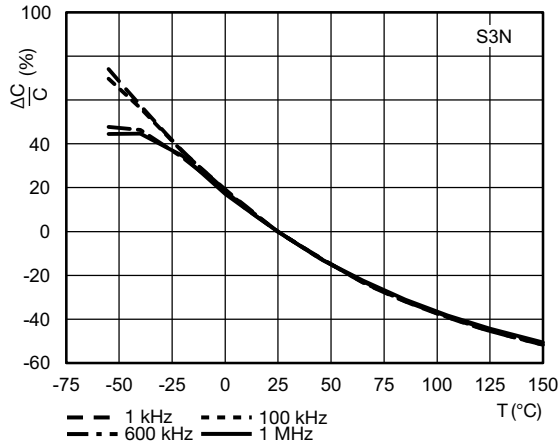

Typical capacitance change as a function of temperature and frequency

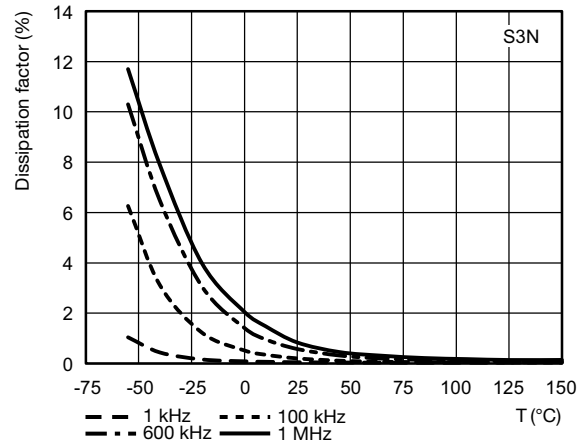

Typical dissipation factor as a function of temperature and frequency

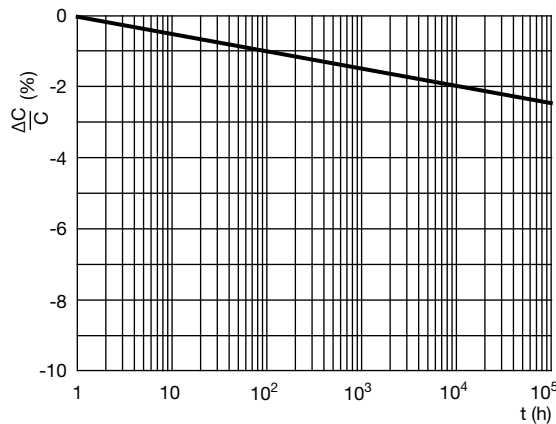

Aging rate as a function of time



## **Disclaimer**

ALL PRODUCT, PRODUCT SPECIFICATIONS AND DATA ARE SUBJECT TO CHANGE WITHOUT NOTICE TO IMPROVE RELIABILITY, FUNCTION OR DESIGN OR OTHERWISE.

Vishay Intertechnology, Inc., its affiliates, agents, and employees, and all persons acting on its or their behalf (collectively, "Vishay"), disclaim any and all liability for any errors, inaccuracies or incompleteness contained in any datasheet or in any other disclosure relating to any product.

Vishay makes no warranty, representation or guarantee regarding the suitability of the products for any particular purpose or the continuing production of any product. To the maximum extent permitted by applicable law, Vishay disclaims (i) any and all liability arising out of the application or use of any product, (ii) any and all liability, including without limitation special, consequential or incidental damages, and (iii) any and all implied warranties, including warranties of fitness for particular purpose, non-infringement and merchantability.

Statements regarding the suitability of products for certain types of applications are based on Vishay's knowledge of typical requirements that are often placed on Vishay products in generic applications. Such statements are not binding statements about the suitability of products for a particular application. It is the customer's responsibility to validate that a particular product with the properties described in the product specification is suitable for use in a particular application. Parameters provided in datasheets and / or specifications may vary in different applications and performance may vary over time. All operating parameters, including typical parameters, must be validated for each customer application by the customer's technical experts. Product specifications do not expand or otherwise modify Vishay's terms and conditions of purchase, including but not limited to the warranty expressed therein.

Except as expressly indicated in writing, Vishay products are not designed for use in medical, life-saving, or life-sustaining applications or for any other application in which the failure of the Vishay product could result in personal injury or death. Customers using or selling Vishay products not expressly indicated for use in such applications do so at their own risk. Please contact authorized Vishay personnel to obtain written terms and conditions regarding products designed for such applications.

No license, express or implied, by estoppel or otherwise, to any intellectual property rights is granted by this document or by any conduct of Vishay. Product names and markings noted herein may be trademarks of their respective owners.

Компания «Океан Электроники» предлагает заключение долгосрочных отношений при поставках импортных электронных компонентов на взаимовыгодных условиях!

Наши преимущества:

- Поставка оригинальных импортных электронных компонентов напрямую с производств Америки, Европы и Азии, а так же с крупнейших складов мира;
- Широкая линейка поставок активных и пассивных импортных электронных компонентов (более 30 млн. наименований);
- Поставка сложных, дефицитных, либо снятых с производства позиций;
- Оперативные сроки поставки под заказ (от 5 рабочих дней);
- Экспресс доставка в любую точку России;
- Помощь Конструкторского Отдела и консультации квалифицированных инженеров;
- Техническая поддержка проекта, помощь в подборе аналогов, поставка прототипов;
- Поставка электронных компонентов под контролем ВП;
- Система менеджмента качества сертифицирована по Международному стандарту ISO 9001;
- При необходимости вся продукция военного и аэрокосмического назначения проходит испытания и сертификацию в лаборатории (по согласованию с заказчиком);
- Поставка специализированных компонентов военного и аэрокосмического уровня качества (Xilinx, Altera, Analog Devices, Intersil, Interpoint, Microsemi, Actel, Aeroflex, Peregrine, VPT, Syfer, Eurofarad, Texas Instruments, MS Kennedy, Miteq, Cobham, E2V, MA-COM, Hittite, Mini-Circuits, General Dynamics и др.);

Компания «Океан Электроники» является официальным дистрибьютором и эксклюзивным представителем в России одного из крупнейших производителей разъемов военного и аэрокосмического назначения «JONHON», а так же официальным дистрибьютором и эксклюзивным представителем в России производителя высокотехнологичных и надежных решений для передачи СВЧ сигналов «FORSTAR».



## JONHON

«JONHON» (основан в 1970 г.)

Разъемы специального, военного и аэрокосмического назначения:

(Применяются в военной, авиационной, аэрокосмической, морской, железнодорожной, горно- и нефтедобывающей отраслях промышленности)

«FORSTAR» (основан в 1998 г.)

ВЧ соединители, коаксиальные кабели, кабельные сборки и микроволновые компоненты:

(Применяются в телекоммуникациях гражданского и специального назначения, в средствах связи, РЛС, а так же военной, авиационной и аэрокосмической отраслях промышленности).



Телефон: 8 (812) 309-75-97 (многоканальный)

Факс: 8 (812) 320-03-32

Электронная почта: [ocean@oceanchips.ru](mailto:ocean@oceanchips.ru)

Web: <http://oceanchips.ru/>

Адрес: 198099, г. Санкт-Петербург, ул. Калинина, д. 2, корп. 4, лит. А