

Smart Sensors (Laser Type) ZX Series (ZX-L-N)



Ordering Information

■ Sensors

Sensor Heads (Reflective)

| Optical system | Beam shape | Sensing distance | Resolution*1 | Model |
|--------------------|------------|------------------|--------------|-----------|
| Diffuse reflective | Spot beam | 40±10 mm | 2 μm | ZX-LD40 |
| | | 100±40 mm | 16 μm | ZX-LD100 |
| | | 300±200 mm | 300 μm | ZX-LD300 |
| | Line beam | 40±10 mm | 2 μm | ZX-LD40L |
| | | 100±40 mm | 16 μm | ZX-LD100L |
| | | 300±200 mm | 300 μm | ZX-LD300L |
| Regular reflective | Spot beam | 30±2 mm | 0.25 μm | ZX-LD30V |
| | Line beam | | | ZX-LD30VL |

*1. For an average count of 4,096.

Sensor Heads (Through-beam)

| Optical system | Measuring width | Sensing distance | Resolution*1 | Model |
|----------------|-----------------|------------------|--------------|-------------|
| Through-beam | 1-mm dia. | 0 to 2000 mm | 4 μm | ZX-LT001 |
| | 5 mm | | | 0 to 500 mm |
| | 10 mm | ZX-LT010 | | |
| | 30 mm | 12 μm | ZX-LT030 | |

*1. For an average count of 64.

Amplifier Units

| Appearance | Power supply | Output type | Model |
|---|--------------|-------------|------------|
|  | DC | NPN | ZX-LDA11-N |
| | | PNP | ZX-LDA41-N |

Note: Compatible connection with the Sensor Head.

Accessories (Order Separately)

Calculating Unit

| Appearance | Model |
|---|---------|
|  | ZX-CAL2 |

Side-view Attachments

| Appearance | Applicable Sensor Head | Model | Quantity |
|---|------------------------|---------|----------|
|  | ZX-LT1001/LT005 | ZX-XF12 | 1 |
| | ZX-LT010 | ZX-XF22 | |

Logging Tool for Personal Computers

| Appearance | Name | | Model |
|---|--|---------|--------------------------|
|  | Communications Interface Unit | RS-232C | ZX-SF11 |
| | | USB | ZX-SF21 |
|  | Smart Monitor (Logging Software + Function Setting Software) | | ZX-SW11EV3 (See note 1.) |

Setup Tool for Personal Computer

| Appearance | Name | Model |
|--|---|---------------------------|
|  | Communications Interface Unit (RS-232C) + Smart Monitor Basic*2 (Function Setting Software) | ZX-SFW11EV3 (See note 1.) |

Note 1. The ZX-SFW11EV3 or ZX-SW11EV3 is required to use the Smart Monitor with the ZX-LDA11-N/41-N. Earlier versions cannot be used.

2. The Smart Monitor Basic does not have a logging function. Other than the logging function, the Smart Monitor Basic supports the same functions as the Smart Monitor.

Cables with Connectors on Both Ends (for Extension)*1

| Cable length | Model | Quantity |
|--------------|---------|----------|
| 1 m | ZX-XC1A | 1 |
| 4 m | ZX-XC4A | |
| 8 m | ZX-XC8A | |
| 9 m *2 | ZX-XC9A | |

*1. Robot Cable models are also available. The model numbers are ZX-XC□R.

*2. For use only with Reflective Sensors.

Specifications

■ Sensor Heads (Reflective)

| Item | Model | ZX-LD40 | ZX-LD100 | ZX-LD300 | ZX-LD30V | ZX-LD40L | ZX-LD100L | ZX-LD300L | Z3X-LD30VL |
|------------------------------------|-------|--|-------------------------|------------------------|---------------------------------------|--|-------------------------|------------------------|---------------------------------------|
| Optical system | | Diffuse reflective | | | Regular reflective | Diffuse reflective | | | Regular reflective |
| Light source (wave length) | | Visible-light semiconductor laser with a wavelength of 650 nm and an output of 1 mW max. EN class 2, FDA class II | | | | | | | |
| Measurement point | | 40 mm | 100 mm | 300 mm | 30 mm | 40 mm | 100 mm | 300 mm | 30 mm |
| Measurement range | | ±10 mm | ±40 mm | ±200 mm | ±2 mm | ±10 mm | ±40 mm | ±200 mm | ±2 mm |
| Beam shape | | Spot | | | Line | | | | |
| Beam size*1 | | 50-μm dia. | 100-μm dia. | 300-μm dia. | 75-μm dia. | 75 μm x 2 mm | 150 μm x 2 mm | 450 μm x 2 mm | 100 μm x 1.8 mm |
| Resolution*2 | | 2 μm | 16 μm | 300 μm | 0.25 μm | 2 μm | 16 μm | 300 μm | 0.25 μm |
| Linearity*3 | | ±0.2% FS (entire range) | ±0.2% FS (80 to 120 mm) | ±2% FS (200 to 400 mm) | ±0.2% FS (entire range) | ±0.2% FS (32 to 48 mm) | ±0.2% FS (80 to 120 mm) | ±2% FS (200 to 400 mm) | ±0.2% FS (entire range) |
| Temperature characteristic*4 | | ±0.03% FS/°C (Except for ZX-LD300 and ZX-LD300L, which are ±0.1% FS/°C.) | | | | | | | |
| Ambient illumination | | Incandescent lamp: 3,000 lx max. (on light receiving side) | | | | | | | |
| Ambient temperature | | Operating: 0 to 50°C, Storage: -15 to 60°C (with no icing or condensation) | | | | | | | |
| Ambient humidity | | Operating and storage: 35% to 85% (with no condensation) | | | | | | | |
| Insulation resistance | | 20 MΩ min. at 500 VDC | | | | | | | |
| Dielectric strength | | 1,000 VAC, 50/60 Hz for 1 min | | | | | | | |
| Vibration resistance (destruction) | | 10 to 150 Hz, 0.7-mm double amplitude 80 min each in X, Y, and Z directions | | | | | | | |
| Shock resistance (destruction) | | 300 m/s ² 3 times each in six directions (up/down, left/right, forward/backward) | | | | | | | |
| Degree of protection | | IEC60529, IP50 | | | IEC60529, IP40 | IEC60529, IP50 | | | IEC60529, IP40 |
| Connection method | | Connector relay (standard cable length: 500 mm) | | | | | | | |
| Weight (packed state) | | Approx. 150 g | | | Approx. 250 g | Approx. 150 g | | | Approx. 250 g |
| Materials | | Case: PBT (polybutylene terephthalate), Cover: Aluminum, Lens: Glass | | | Case and cover: Aluminum, Lens: Glass | Case: PBT (polybutylene terephthalate), Cover: Aluminum, Lens: Glass | | | Case and cover: Aluminum, Lens: Glass |
| Accessories | | Instruction sheet, Laser warning label (English) | | | | | | | |

*1. Beam size: The beam size is defined by $1/e^2$ (13.5%) of the strength of the beam at the beam center (measured value). Incorrect detection may occur if there is light leakage outside the defined spot and the material around the sensing object is more reflective than the sensing object.

*2. Resolution: The resolution is the deviation ($\pm 3\sigma$) in the linear output when connected to the ZX-LDA Amplifier Unit. (The resolution is measured with the standard reference object (white ceramic), at the measurement point with the ZX-LDA set for an average count of 4,096 per period.) The resolution is given at the repeat accuracy for a stationary workpiece, and is not an indication of the distance accuracy. The resolution may be adversely affected under strong electromagnetic fields.

*3. Linearity: The linearity is given as the error in an ideal straight line displacement output when measuring the standard reference object. The linearity and measurement values vary with the object being measured.

*4. Temperature characteristic: The temperature characteristic is measured at the measurement point with the Sensor and reference object (OMRON's standard reference object) secured with an aluminum jig.

Note: Highly reflective objects can result in incorrect detection by causing out-of-range measurements.

■ Sensor Heads (Through-beam)

| Item | Model | ZX-LT001 | ZX-LT005 | ZX-LT010 | ZX-LT030 |
|-----------------------------------|--|---------------------------------|-----------------------|----------------------|-----------------------------|
| Optical system | Through-beam | | | | |
| Light source (wave length) | Visible-light semiconductor laser with a wavelength of 650 nm EN class 1, FDA class II | | | | |
| Maximum output | 0.2 mW max. | | 0.35 mW max. | | 0.2 mW max. |
| Measurement width | 1-mm dia. | 1- to 2.5-mm dia. | 5 mm | 10 mm | 30 mm |
| Measurement distance | 0 to 500 mm | 500 to 2,000 mm | 0 to 500 mm | | |
| Minimum sensing object | 8- μ m dia. (opaque) | 8- to 50- μ m dia. (opaque) | 0.05-mm dia. (opaque) | 0.1-mm dia. (opaque) | 0.3-mm dia. (opaque) |
| Resolution*1 | 4 μ m *2 | --- | 4 μ m *3 | | 12 μ m *4 |
| Temperature characteristic | \pm 0.2% FS/ $^{\circ}$ C | | | | \pm 0.3% FS/ $^{\circ}$ C |
| Ambient illumination | Incandescent lamp: 10,000 lx max. (on light-receiving side) | | | | |
| Ambient temperature | Operating: 0 to 50 $^{\circ}$ C, Storage: -25 to 70 $^{\circ}$ C (with no icing or condensation) | | | | |
| Ambient humidity | Operating: 35% to 85% (with no condensation) | | | | |
| Degree of protection | IEC60529, IP40 | | | | |
| Connection method | Connector relay (standard cable length: 500 mm) | | | | |
| Weight (packed state) | Approx. 220 g | | | | Approx. 450 g |
| Cable length | Extendable up to 10 m with special extension cable. | | | | |
| Materials | Case | Polyetherimide | | | Zinc die-cast |
| | Cover | Polycarbonate | | | |
| | Front filter | Glass | | | |
| Tightening torque | 0.3 N·m max. | | | | |
| Accessories | Instruction sheet, Sensor Head-Amplifier Connection Cable | | | | Mounting Bracket |
| | Optical axis adjustment seal | | | | |

*1. This value is obtained by converting the deviation ($\pm 3\sigma$) in the linear output that results when the sensor head is connected to the amplifier unit, into the measurement width.

*2. For an average count of 64. The value is 5 μ m for an average count of 32.
This is the value that results when a minimum sensing object blocks the light near the center of the 1-mm measurement width.

*3. For an average count of 64. The value is 5 μ m for an average count of 32.

*4. For an average count of 64. The value is 15 μ m for an average count of 32.

■ Amplifier Units

| Item | Model | ZX-LDA11-N | ZX-LDA41-N |
|--|-------|--|---|
| Measurement period | | 150 μs | |
| Possible average count settings*1 | | 1, 2, 4, 8, 16, 32, 64, 128, 256, 512, 1,024, 2,048, or 4,096 | |
| Temperature characteristic | | When connected to a Reflective Sensor Head: 0.01% FS/°C, When connected to a Through-beam Sensor Head: 0.1% FS/°C | |
| Linear output*2 | | 4 to 20 mA/FS, Max. load resistance: 300 Ω, ±4 V (± 5 V, 1 to 5 V *3), Output impedance: 100 Ω | |
| Judgement outputs (3 outputs: HIGH/PASS/LOW)*1 | | NPN open-collector outputs, 30 VDC, 50 mA max. Residual voltage: 1.2 V max. | PNP open-collector outputs, 30 VDC, 50 mA max. Residual voltage: 2 V max. |
| Laser OFF input, zero reset input, timing input, reset input | | ON: Short-circuited with 0-V terminal or 1.5 V or less OFF: Open (leakage current: 0.1 mA max.) | ON: Supply voltage short-circuited or supply voltage within 1.5 V OFF: Open (leakage current: 0.1 mA max.) |
| Functions | | Measurement value display, present value/set value/light level/resolution display, scaling, display reverse, display OFF mode, ECO mode, number of display digit changes, sample hold, peak hold, bottom hold, peak-to-peak hold, self-peak hold, self-bottom hold, average hold, delay hold, intensity mode, zero reset, initial reset, ON-delay timer, OFF-delay timer, one-shot timer, deviation, previous value comparison, sensitivity adjustment, keep/clamp switch, direct threshold value setting, position teaching, 2-point teaching, automatic teaching, hysteresis width setting, timing inputs, reset input, monitor focus, linear output compensation, (A-B) calculations*4, (A+B) calculations*4, mutual interference*4, laser deterioration detection, zero reset memory, zero reset display, key lock | |
| Indications | | Operation indicators: High (orange), pass (green), low (yellow), 7-segment main display (red), 7-segment subdisplay (yellow), laser ON (green), zero reset (green), enable (green) | |
| Power supply voltage | | 12 to 24 VDC ±10%, Ripple (p-p): 10% max. | |
| Current consumption | | 140 mA max. with power supply voltage of 24 VDC (with Sensor connected) | |
| Ambient temperature | | Operating: 0 to 50°C, Storage: -15 to 60°C (with no icing or condensation) | |
| Ambient humidity | | Operating and storage: 35% to 85% (with no condensation) | |
| Insulation resistance | | 20 MΩ min. at 500 VDC | |
| Dielectric strength | | 1,000 VAC, 50/60 Hz for 1 min | |
| Vibration resistance (destruction) | | 10 to 150 Hz, 0.7-mm double amplitude 80 min each in X, Y, and Z directions | |
| Shock resistance (destruction) | | 300 m/s ² 3 times each in six directions (up/down, left/right, forward/backward) | |
| Connection method | | Prewired (standard cable length: 2 m) | |
| Weight (packed state) | | Approx. 350 g | |
| Materials | | Case: PBT (polybutylene terephthalate), Cover: Polycarbonate | |
| Accessories | | Instruction sheet | |

*1. The response speed of the linear output is calculated as the measurement period × (average count setting + 1) (with fixed sensitivity).
The response speed of the judgement outputs is calculated as the measurement period × (average count setting + 1) (with fixed sensitivity).

*2. The output can be switched between a current output and voltage output using a switch on the bottom of the Amplifier Unit.

*3. Setting is possible via the monitor focus function.

*4. A Calculating Unit (ZX-CAL2) is required.

■ Calculating Unit

| Item | ZX-CAL2 |
|------------------------------------|---|
| Applicable Amplifier Units | ZX-LDA11-N/41-N/ZX-EDA11/41/ZX-TDA11/41 |
| Current consumption | 12 mA max. (supplied from the Smart Sensor Amplifier Unit) |
| Ambient temperature | Operating: 0 to 50°C, Storage: -15 to 60°C (with no icing or condensation) |
| Ambient humidity | Operating and storage: 35% to 85% (with no condensation) |
| Connection method | Connector |
| Dielectric strength | 1,000 VAC, 50/60 Hz for 1 min |
| Insulation resistance | 100 MΩ (at 500 VDC) |
| Vibration resistance (destructive) | 10 to 150 Hz, 0.7-mm double amplitude 80 min each in X, Y, and Z directions |
| Shock resistance (destructive) | 300 m/s ² 3 times each in six directions (up/down, left/right, forward/backward) |
| Materials | Display: Acrylic, Case: ABS resin |
| Weight (packed state) | Approx. 50 g |

■ ZX-series Communications Interface Unit

| Item | ZX-SF11 | |
|------------------------------------|---|---|
| Current consumption | 60 mA max. (supplied by the Amplifier Unit) | |
| Applicable Amplifier Units | ZX Series | |
| Applicable Amplifier Unit versions | ZX-LDA□1-N Ver. 1.000 or higher ZX-EDA□1 Ver. 1.100 or higher ZX-TDA□1 Ver. 1.000 or higher | |
| Max. No. of Amplifier Units | 5 | |
| Communications functions | Communications port | RS-232C port (9-pin D-Sub Connector) |
| | Communications protocol | CompoWay/F* |
| | Baud rate | 38,400 bps |
| | Data configuration | Data bits: 8, Parity: none, Start bits: 1, Stop bits: 1, Flow control: none |
| Indicators | Power supply: green, Sensor communications: green, Sensor communications error: red, External terminal communications: green, External terminal communications error: red | |
| Protective circuits | Reverse polarity protection | |
| Ambient temperature | Operating: 0 to 50°C, storage: -15 to 60°C (with no icing or condensation) | |
| Ambient humidity | Operating and storage: 35% to 85% (with no condensation) | |
| Insulation resistance | 20 MΩ min. (at 500 VDC) | |
| Dielectric strength | 1,000 VAC, 50/60 Hz for 1 min, Leakage current: 10 mA max. | |
| Materials | Case: PBT (polybutylene terephthalate), Cover: Polycarbonate | |
| Accessories | Instruction sheet, 2 clamps | |

* Contact your OMRON representative for CompoWay/F communications specifications.

Engineering Data (Typical)

Angle Characteristic (Reflective Sensors)

The angle characteristic plots the relation between the inclination of the measurement object and the error in the linear output at the measurement point.

Note: SUS304 = Stainless steel SUS304

● ZX-LD40

Side-to-side Inclination



Front-to-back Inclination



● ZX-LD40L

Side-to-side Inclination



Front-to-back Inclination



● ZX-LD100

Side-to-side Inclination



Front-to-back Inclination



● ZX-LD100L

Side-to-side Inclination

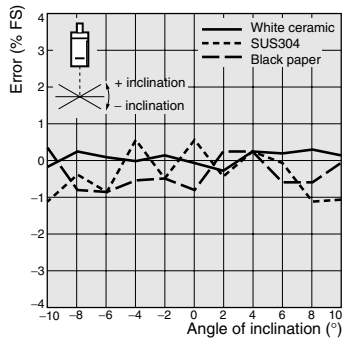

Front-to-back Inclination



● ZX-LD300

Side-to-side Inclination



Front-to-back Inclination



● ZX-LD300L

Side-to-side Inclination

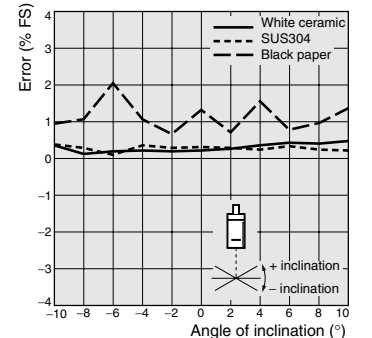

Front-to-back Inclination



● ZX-LD30V

Side-to-side Inclination



Front-to-back Inclination



● ZX-LD30VL

Side-to-side Inclination



Front-to-back Inclination



Linearity Characteristic for Different Materials (Reflective Sensors)

● ZX-LD40

0° Inclination

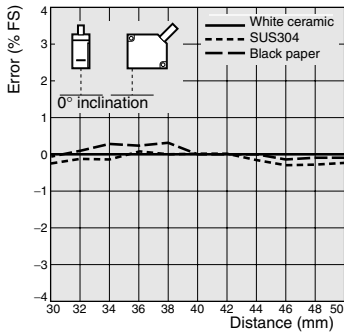

-10° Inclination Front-to-back

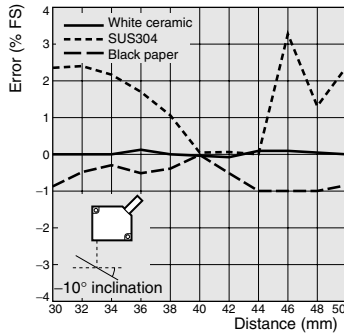

10° Inclination



● ZX-LD100

0° Inclination

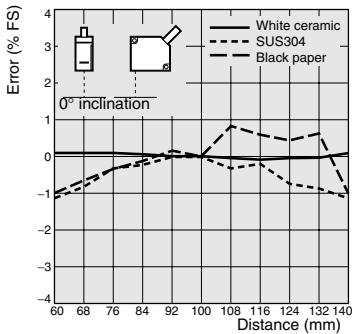

-10° Inclination Front-to-back

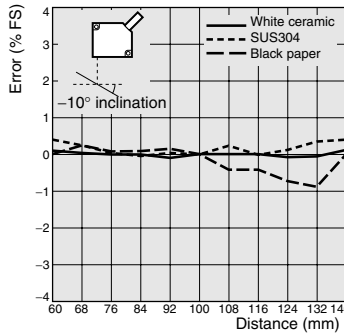

10° Inclination

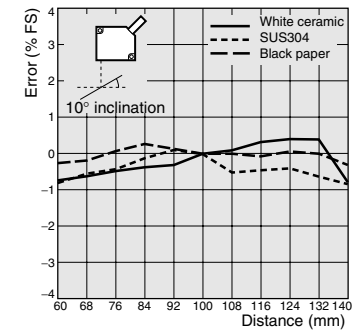

● ZX-LD300

0° Inclination

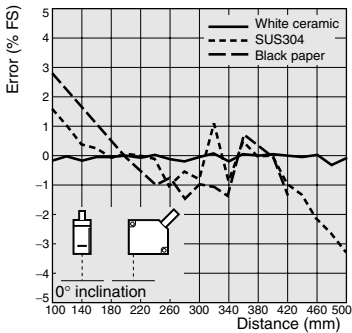

-10° Inclination Front-to-back

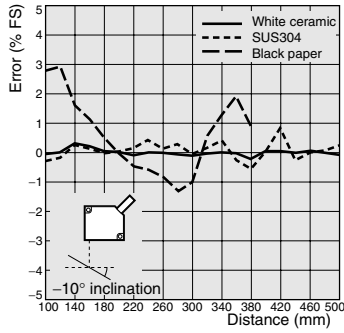

10° Inclination

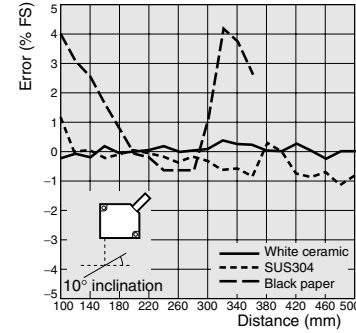

● ZX-LD40L

0° Inclination

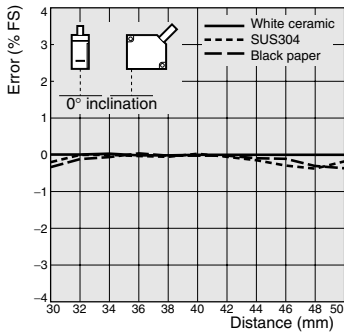

-10° Inclination Front-to-back

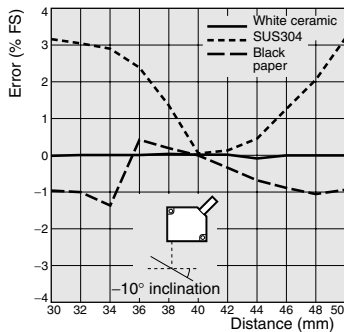

10° Inclination

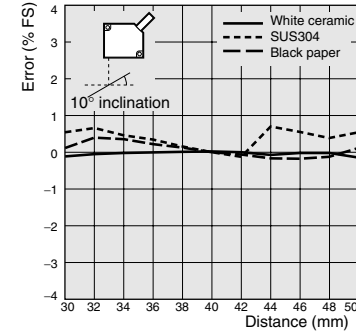

● ZX-LD100L

0° Inclination



-10° Inclination Front-to-back



10° Inclination



● ZX-LD300L

0° Inclination



-10° Inclination Front-to-back



10° Inclination



● ZX-LD30V

0° Inclination

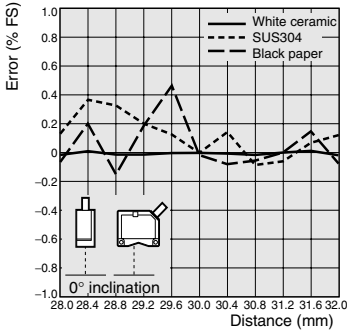

-10° Inclination Front-to-back



10° Inclination



● ZX-LD30VL

0° Inclination



-10° Inclination Front-to-back



10° Inclination



**Beam Size
(Reflective Sensors)**

● **Spot Beams**

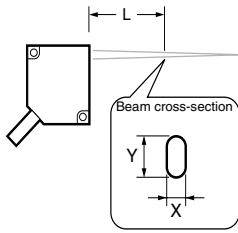

ZX-LD40

| L | 30 mm | 40 mm | 50 mm |
|---|--------|---------|--------|
| X | 240 μm | 40.0 μm | 250 μm |
| Y | 350 μm | 30.0 μm | 370 μm |

ZX-LD100

| L | 60 mm | 100 mm | 140 mm |
|---|--------|---------|--------|
| X | 390 μm | 100 μm | 430 μm |
| Y | 620 μm | 65.0 μm | 650 μm |

ZX-LD300

| L | 100 mm | 300 mm | 500 mm |
|---|----------|--------|----------|
| X | 1,050 μm | 180 μm | 1,100 μm |
| Y | 450 μm | 300 μm | 850 μm |

● **Line Beams**

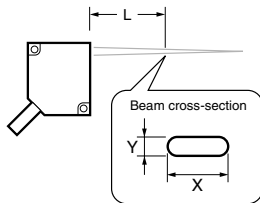

ZX-LD40L

| L | 30 mm | 40 mm | 50 mm |
|---|----------|----------|----------|
| X | 2,000 μm | 2,000 μm | 2,000 μm |
| Y | 240 μm | 50.0 μm | 250 μm |

ZX-LD100L

| L | 60 mm | 100 mm | 140 mm |
|---|----------|----------|----------|
| X | 2,000 μm | 2,000 μm | 2,000 μm |
| Y | 410 μm | 100 μm | 430 μm |

ZX-LD300L

| L | 100 mm | 300 mm | 500 mm |
|---|----------|----------|----------|
| X | 2,000 μm | 2,000 μm | 2,500 μm |
| Y | 750 μm | 300 μm | 650 μm |

● **Spot Beams**

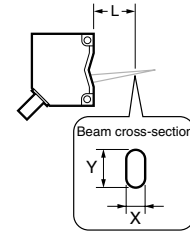

ZX-LD30V

| L | 28 mm | 30 mm | 32 mm |
|---|---------|---------|---------|
| X | 60.0 μm | 30.0 μm | 120 μm |
| Y | 50.0 μm | 40.0 μm | 90.0 μm |

● **Line Beams**

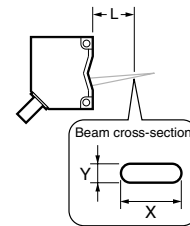

ZX-LD30VL

| L | 28 mm | 30 mm | 32 mm |
|---|----------|----------|----------|
| X | 1,800 μm | 1,800 μm | 1,800 μm |
| Y | 90.0 μm | 60.0 μm | 110 μm |

Sensing Object Characteristics (Through-beam Sensors)

● ZX-LT001

(For 0.02-mm-dia. pin gauge)



● ZX-LT001

(For 0.05-mm-dia. pin gauge)



● ZX-LT005

(For 0.05-mm-dia. pin gauge)



● ZX-LT010

(For 0.1-mm-dia. pin gauge)



Linearity Characteristics

● ZX-LT005



● ZX-LT010



Linear Output vs. Sensing Distance

The output can be switched between a current output and a voltage output using a switch on the Amplifier Unit.

ZX-LD40/LD40L

Current Output

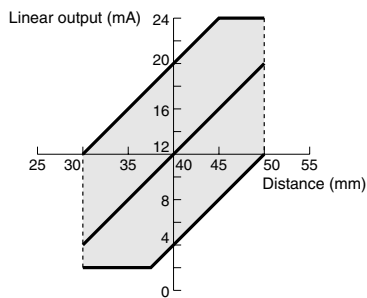

Voltage Output

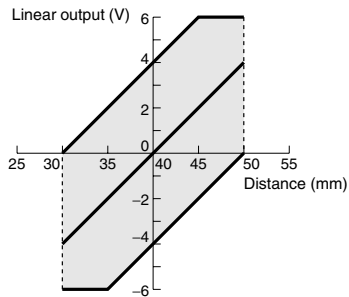

ZX-LD100/LD100L

Current Output

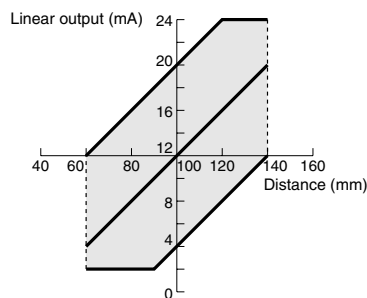

Voltage Output

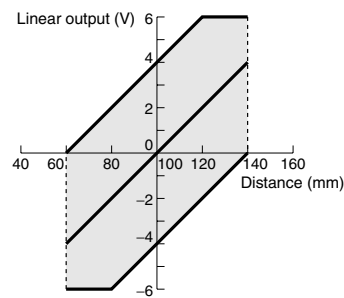

ZX-LD300/LD300L

Current Output

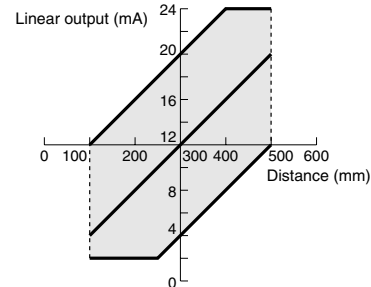

Voltage Output

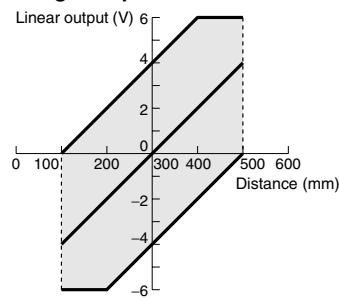

ZX-LD30V/LD30VL

Current Output

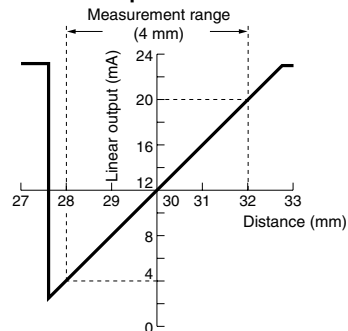

Voltage Output

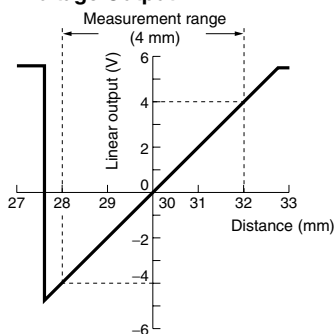

I/O Circuit Diagrams

NPN Amplifier Unit: ZX-LDA11-N



PNP Amplifier Unit: ZX-LDA41-N



Connections: Amplifier Unit



- Note 1.** Use a separate stabilized power supply for the Amplifier Unit, particularly when high resolution is required.
- 2.** Wire the Unit correctly. Incorrect wiring may result in damage to the Unit. (Do not allow wiring, particularly the linear output, to come into contact with other lines.)
- 3.** Use the 0-V line (blue) for the power supply and use the shield wire (linear output ground) together with the linear output (black line) for linear output. Each of these grounds must be used for the designed purpose. When not using the linear output, connect the linear ground (shield) to the 0-V ground.

Part Names

Sensor Heads (Reflective)

- ZX-LD40
- ZX-LD100
- ZX-LD300
- ZX-LD40L
- ZX-LD100L
- ZX-LD300L
- ZX-LD30V*
- ZX-LD30VL*



Amplifier Units

- ZX-LDA11-N
- ZX-LDA41-N



*The dimensions for these models are slightly different. Refer to page 23 for details.

Sensor Heads (Through-beam)

- ZX-LT001
- ZX-LT005
- ZX-LT010
- ZX-LT030



Calculating Unit

- ZX-CAL2



Precautions

■ Design Precautions

Ratings and Performance

- Conform to the specified ratings and performance. Refer to *Specifications* for details.
 1. Do not impose voltage exceeding the rated voltage, otherwise the Sensor may be damaged.
 2. When supplying power to the Sensor, make sure that the polarity of the power is correct, otherwise, the Sensor may be damaged. Do not connect to an AC power supply.
 3. Do not short-circuit the load for the open collector output, otherwise the Sensor may be damaged.
- Do not disconnect the connector connecting the Sensor Head and the controller while power is being supplied, otherwise the Sensor may be damaged.
- Allow a warm-up period of approximately 10 minutes after turning ON the power supply.
- Objects of certain materials or shapes may not be detectable, or the detection accuracy may not be sufficiently high. These include materials that are transparent or have extremely low reflectivity, and objects that are smaller than the Sensor's spot diameter or have extreme curvature or inclination.

Power Supply and Wiring

- Prior to turning ON the power supply after wiring is completed, check to make sure that the power supply is correct, that there are no mistaken connections, e.g., connections that would short-circuit the load, and that the load current is appropriate. Incorrect wiring may result in damage to the Sensor or Unit.
- The total length of the Sensor cable or Amplifier cable must be 10 m or less. Use an ZX-XC□A Extension Cable (order separately) if required to extend the cable from the Sensor. Use a shielded cable to extend the Amplifier cable. The shielded cable must be the same as that of the Amplifier cable.
- Do not lay a power supply cable for the ZX together with high-voltage lines or power lines to prevent interference, damage, and malfunction.
- When using a commercially available switching regulator, ground the FG (frame ground) terminal.
- If the power supply line is subject to surges, connect a surge absorber that meets the conditions of the usage environment.
- When using a Calculating Unit, connect the corresponding linear ground of the Amplifier Unit.

Compatibility

- All Sensor Heads and Amplifier Units are compatible. Different Sensor Heads may be purchased at a later date and used with existing Amplifier Units.

Mutual Interference

- Two Sensor Heads can be used together, without danger of mutual interference, by connecting the ZX-CAL 2 Calculating Unit between two Amplifier Units.

Maintenance

- Always turn OFF the power supply before adjusting or removing the Sensor Head.
- Cleaning

Do not use thinners, benzine, acetone, or kerosene for cleaning. If dust or oil adheres to the filter on the front of the Sensor Head, use the following procedure to clean.

 1. Use a blower brush (used to clean camera lenses) to blow large dust particles from the surface. Do not blow the dust away with your mouth.
 2. Use a soft cloth (for lenses) with a small amount of alcohol to remove the remaining dust. Do not use a scrubbing action when cleaning because scratches on the filter could result in Sensor inaccuracy.

■ Other Precautions

Environment

1. Do not use the Sensor in strong electromagnetic fields or in an environment where the operation of the Sensor is subject to the reflection of intense light (such as other laser beams or electric arc-welding machines.)
2. Do not operate the Sensor in the following locations:
 - Locations subject to strong vibration.
 - Locations subject to direct sunlight or near heating equipment.
 - Locations subject to high humidity.
 - Locations where the Sensor would accumulate dust, dirt, metallic powder, etc.
 - Locations subject to corrosive or flammable gases.
 - Locations subject to exposure to organic solvents, water, oil, etc.
 - Locations subject to strong electromagnetic or electrical fields.
 - Locations subject to rapid changes in temperature.
 - Locations subject to freezing.

Laser Safety

The ZX-LD-Series Sensor Heads are FDA Class II and EN Class 2 Laser Products. The ZX-LT-Series Sensor Heads are FDA Class II and EN Class 1 Laser Products. The ZX Series is meant to be built into final system equipment. Pay special attention to the following precautions for the safe use of the product:

Note: Europe: Class 1 and Class 2 of EN60825-1: 1994 = IEC825-1: 1993
 U.S.A.: Class I and Class II of FDA (21 CFR1040.10)

1. Use this product as specified in this instruction manual. Otherwise, you may be exposed to hazardous laser radiation.
2. The ZX-series Smart Sensors radiate laser beams in the visible light range. Do not expose your eyes directly to the laser radiation. Ensure that the laser beam path is terminated during use. If a mirror or shiny surface is positioned in the laser beam path, ensure that the reflected beam path is also terminated. If the Unit must be used without terminating the laser beam path, position the laser beam path so that it is not at eye level.
3. To avoid exposure to hazardous laser radiation, do not displace nor remove the protective housing during operation, maintenance, and any other servicing.
4. The user should return the product to OMRON for all repair and servicing.
5. As for other countries, observe the regulations and standards specified by each country.

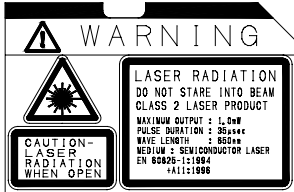

Requirements from Regulations and Standards

EN60825-1 “Safety of Laser Products, Equipment Classification, Requirements and User’s Guide”

● Summary of Manufacturer’s Requirements

| Requirements; Sub-clause | Classification | | | | |
|--|--|---|--|--|--|
| | Class 1 | Class 2 | Class 3A | Class 3B* | Class 4 |
| Description of hazard class | Safe under reasonably foreseeable conditions | Low power; eye protection normally afforded by aversion responses | Same as Class 2. Direct intrabeam viewing with optical aids may be hazardous | Direct intrabeam viewing may be hazardous | High power; diffused reflection may be hazardous |
| Protective housing | Required for each laser product; limits access necessary for performance of functions of the products | | | | |
| Safety interlock in protective housing | Designed to prevent removal of the panel until accessible emission values are below the AEL (see note 2) for the class assigned | | | | |
| Remote control | Not required | | | Permits easy addition of external interlock in laser installation | |
| Key control | Not required | | | Laser inoperative when key is removed | |
| Emission warning device | Not required | | | Gives audible or visible warning when laser is switched on or if capacitor bank of pulsed laser is being charged | |
| Attenuator | Not required | | | Gives means beside ON/OFF switch to temporarily block beam | |
| Location controls | Not required | | Controls so located that there is no danger of exposure to AEL above Classes 1 or 2 when adjustments are made. | | |
| Viewing optics | Emission from all viewing systems must be below Class 1 AEL's as applicable | | | | |
| Scanning | Scan failure shall not cause product to exceed its classification | | | | |
| Class label | Required wording | Figures A and B and specified wording | | | |
| Aperture label | Not required | | | Specified wording required | |
| Service entry label | Required as appropriate to the class of accessible radiation | | | | |
| Override interlock label | Required under certain conditions as appropriate to the class of laser used | | | | |
| User information | Operation manuals must contain instructions for safe use | | | | |
| Purchasing and service information | Promotion brochures must reproduce classification labels; service manuals must contain safety information | | | | |
| Medical products | Special calibration instructions required | | | Special calibration instructions, means for measurement and target-indicator required | |
| Fibre optic | Cable service connections require tool to disconnect if disconnection breaks protective housing and permits access above Class 1 | | | | |

*With respect to the requirements of remote interlock connector, key control, emission warning and attenuator, Class 3B laser products not exceeding five times the AEL of Class 2 in the wavelength range of 400 nm to 700 nm are to be treated as Class 3A laser products.

Note 1. This table is intended to provide a convenient summary of requirements. See text of this standard for complete requirements.

2. AEL: Accessible Emission Limit

The maximum accessible emission level permitted within a particular class.
 For your reference, see ANSI Z136.1-1993, Section 2.

Symbol and border: black
 Background: yellow



Figure A Warning label - Hazard symbol

Legend and border: black
 Background: yellow



Figure B Explanatory label

● FDA (Compliance Guide for Laser Products, 1985, according to 21 CFR1040.10)

| Requirements | Class (see note 1) | | | | | |
|---|--------------------|--------------------|--------------------|--------------------|--------------------|--------------------|
| | I | Ila | II | IIla | IIlb | IV |
| Performance (all laser products) | | | | | | |
| Protective housing | R (see note 2) | R (see note 2) | R (see note 2) | R (see note 2) | R (see note 2) | R (see note 2) |
| Safety interlock | R (see notes 3, 4) | R (see notes 3, 4) | R (see notes 3, 4) | R (see notes 3, 4) | R (see notes 3, 4) | R (see notes 3, 4) |
| Location of controls | N/A | R | R | | R | R |
| Viewing optics | R | R | R | R | R | R |
| Scanning safeguard | R | R | R | R | R | R |
| Performance (laser systems) | | | | | | |
| Remote control connector | N/A | N/A | N/A | N/A | R | R |
| Key control | N/A | N/A | N/A | N/A | R | R |
| Emission indicator | N/A | N/A | R | R | R (see note 10) | R (see note 10) |
| Beam attenuator | N/A | N/A | R | R | R | R |
| Reset | N/A | N/A | N/A | N/A | N/A | R (see note 13) |
| Performance (specific purpose products) | | | | | | |
| Medical | S | S | S | S (see note 8) | S (see note 8) | S (see note 8) |
| Surveying, leveling, alignment | S | S | S | S | NP | NP |
| Demonstration | S | S | S | S | S (see note 11) | S (see note 11) |
| Labeling (all laser products) | | | | | | |
| Certification & identification | R | R | R | R | R | R |
| Protective housing | D (see note 5) | D (see note 5) | D (see note 5) | D (see note 5) | D (see note 5) | D (see note 5) |
| Aperture | N/A | N/A | R | R | R | R |
| Class warning | N/A | R (see note 6) | R (see note 7) | R (see note 9) | R (see note 12) | R (see note 12) |
| Information (all laser products) | | | | | | |
| User information | R | R | R | R | R | R |
| Product literature | N/A | R | R | R | R | R |
| Service information | R | R | R | R | R | R |

Abbreviations:

- R: Required.
- N/A: Not applicable.
- S: Requirements: Same as for other products of that Class. Also see footnotes.
- NP: Not permitted.
- D: Depends on level of interior radiation.

Footnotes:

1. Based on highest level accessible during operation.
2. Required wherever & whenever human access to laser radiation above Class I limits is not needed for product to perform its function.
3. Required for protective housings opened during operation or maintenance, if human access thus gained is not always necessary when housing is open.
4. Interlock requirements vary according to Class of internal radiation.
5. Wording depends on level & wavelength of laser radiation within protective housing.
6. Warning statement label.
7. CAUTION logotype.
8. Requires means to measure level of laser radiation intended to irradiate the body.
9. CAUTION if 2.5 mW cm² or less, DANGER if greater than 2.5 mW cm².
10. Delay required between indication & emission.
11. Variance required for Class IIb or IV demonstration laser products and light shows.
12. DANGER logotype.
13. Required after August 20, 1986.

Use Precautions

● EN60825-1

| Requirements; Sub-clause | Classification | | | | |
|-----------------------------|-----------------|--|--|---|-----------------------|
| | Class 1 | Class 2 | Class 3A | Class 3B* | Class 4 |
| Remote interlock | Not required | | | Connect to room or door circuits | |
| Key control | Not required | | | Remove key when not in use | |
| Beam attenuator | Not required | | | When in use prevents inadvertent exposure | |
| Emission indicator device | Not required | | | Indicates laser is energized | |
| Warning signs | Not required | | | Follow precautions on warning signs | |
| Beam path | Not required | Terminate beam at end of useful length | | | |
| Specular reflection | No requirements | | | Prevent unintentional reflections | |
| Eye protection | No requirements | | Required if engineering and administrative procedures not practicable and MPE exceeded | | |
| Protective clothing | No requirements | | | Sometimes required | Specific requirements |
| Training | No requirements | | Required for all operator and maintenance personnel | | |

*With respect to the requirements of remote interlock connector, key control, beam attenuator, and emission indicator, Class 3B laser products not exceeding five times the AEL of Class 2 in the wavelength range of 400 nm to 700 nm are to be treated as Class 3A laser products.

Note: This table is intended to provide a convenient summary of requirements. See text of this standard for complete precautions.

● ANSI Z136.1:1993 “American National Standard for the Safe Use of Lasers” Control Measures for the Four Laser Classes

| Control measures | Classification | | | | | |
|---|---|----------|----------|-------------------|----------|----------|
| | 1 | 2a | 2 | 3a | 3b | 4 |
| Engineering Controls | 1 | 2a | 2 | 3a | 3b | 4 |
| Protective Housing (4.3.1) | X | X | X | X | X | X |
| Without Protective Housing (4.3.1.1) | LSO (see note 2) shall establish Alternate Controls | | | | | |
| Interlocks on Protective Housing (4.3.2) | ☆ | ☆ | ☆ | ☆ | X | X |
| Service Access Panel (4.3.3) | ☆ | ☆ | ☆ | ☆ | X | X |
| Key Control (4.3.4) | --- | --- | --- | --- | • | X |
| Viewing Portals (4.3.5.1) | --- | --- | MPE | MPE | MPE | MPE |
| Collecting Optics (4.3.5.2) | MPE | MPE | MPE | MPE | MPE | MPE |
| Totally Open Beam Path (4.3.6.1) | --- | --- | --- | --- | X NHZ | X NHZ |
| Limited Open Beam Path (4.3.6.2) | --- | --- | --- | --- | X NHZ | X NHZ |
| Enclosed Beam Path (4.3.6.3) | None is required if 4.3.1 and 4.3.2 fulfilled | | | | | |
| Remote Interlock Connector (4.3.7) | --- | --- | --- | --- | • | X |
| Beam Stop or Attenuator (4.3.8) | --- | --- | --- | --- | • | X |
| Activation Warning Systems (4.3.9) | --- | --- | --- | --- | • | X |
| Emission Delay (4.3.9.1) | --- | --- | --- | --- | --- | X |
| Indoor Laser Controlled Area (4.3.10) | --- | --- | --- | --- | X NHZ | X NHZ |
| Class 3b Laser Controlled Area (4.3.10.1) | --- | --- | --- | --- | X | --- |
| Class 4 Laser Controlled Area (4.3.10.2) | --- | --- | --- | --- | --- | X |
| Laser Outdoor Controls (4.3.11) | --- | --- | --- | --- | X NHZ | X NHZ |
| Laser in Navigable Airspace (4.3.11.2) | --- | --- | --- | • | • | • |
| Temporary Laser Controlled Area (4.3.12) | ☆ MPE | ☆ MPE | ☆ MPE | ☆ MPE | --- | --- |
| Remote Firing & Monitoring (4.3.13) | --- | --- | --- | --- | --- | • |
| Labels (4.3.14 and 4.7) | X | X | X | X | X | X |
| Area Posting (4.3.15) | --- | --- | --- | • | X NHZ | X NHZ |
| Administrative & Procedural Controls | 1 | 2a | 2 | 3a | 3b | 4 |
| Standard Operating Procedures (4.4.1) | --- | --- | --- | --- | • | X |
| Output Emission Limitations (4.4.2) | --- | --- | --- | LSO Determination | | |
| Education and Training (4.4.3) | --- | --- | • | • | X | X |
| Authorized Personnel (4.4.4) | --- | --- | --- | --- | X | X |
| Alignment Procedures (4.4.5) | --- | --- | X | X | X | X |

| Control measures | Classification | | | | | |
|--|---------------------|----------|----------|----------|----------|----------|
| | | | | | | |
| Protective Equipment (4.4.6) | --- | --- | --- | --- | • | X |
| Spectator (4.4.7) | --- | --- | --- | --- | • | X |
| Service Personnel (4.4.8) | ☆ MPE | ☆ MPE | ☆ MPE | ☆ MPE | X | X |
| Demonstration with General Public (4.5.1) | MPE † | --- | X | X | X | X |
| Laser Optical Fiber Systems (4.5.2) | MPE | MPE | MPE | MPE | X | X |
| Laser Robotic Installations (4.5.3) | --- | --- | --- | --- | X NHZ | X NHZ |
| Eye Protection (4.6.2) | --- | --- | --- | --- | • MPE | X MPE |
| Protective Windows (4.6.3) | --- | --- | --- | --- | X NHZ | X NHZ |
| Protective Barriers and Curtains (4.6.4) | --- | --- | --- | --- | • | • |
| Skin Protection (4.6.5) | --- | --- | --- | --- | X MPE | X MPE |
| Other Protective Equipment (4.6.5) | Use may be required | | | | | |
| Warning Signs and Labels (4.7) (Design Requirements) | --- | --- | • | • | X NHZ | X NHZ |
| Service and Repairs (4.8) | LSO Determination | | | | | |
| Modification of Laser Systems (4.9) | LSO Determination | | | | | |

Note 1. LEGEND

- X: Shall
- : Should
- : No requirement
- ☆: Shall if enclosed Class 3b or Class 4
- MPE: Shall if MPE is exceeded
- NHZ: Nominal Hazard Zone analysis required
- †: Applicable only to UV and IR Lasers (4.5.1.2)

2. LSO: Laser Safety Officer

An individual shall be designated the Laser Safety Officer with the authority and responsibility to monitor and enforce the control of laser hazards, and to effect the knowledgeable evaluation and control of laser hazards.
For your reference, see ANSI Z136.1-1993, Section 1.3.

Laser Product Classifications

● EN

| Class | Description |
|----------|---|
| Class 1 | Lasers which are safe under reasonably foreseeable conditions of operation. |
| Class 2 | Lasers emitting visible radiation in the wavelength range from 400 nm to 700 nm. Eye protection is normally afforded by aversion responses including the blink reflex. |
| Class 3A | Lasers which are safe for viewing with the unaided eye. For laser emitting in the wavelength range from 400 nm to 700 nm, protection is afforded by aversion responses including the blink reflex. For other wavelengths the hazard to the unaided eye is no greater than for Class 1. Direct intrabeam viewing of Class 3A lasers with optical aides (e.g., binoculars, telescopes, microscopes) may be hazardous. |
| Class 3B | Direct intrabeam viewing of these lasers is always hazardous. Viewing diffuse reflections is normally safe (see note). |
| Class 4 | Lasers which are also capable of producing hazardous diffuse reflections. They may cause skin injuries and could also constitute a fire hazard. Their use requires extreme caution. |

Note: Conditions for safe viewing of diffuse reflections for Class 3B visible lasers are: minimum viewing distance of 13 cm between screen and cornea and a maximum viewing time of 10 s. Other viewing conditions require a comparison of the diffuse reflection exposure with the MPE.

Comparison of Classifications between FDA and ANSI

| Class | FDA definition | ANSI description |
|---------------|--|---|
| Class I/1 | Limits applicable to devices that have emissions in the ultraviolet, visible, and infrared spectra, and limits below which biological hazards have not been established. | A Class 1 laser is considered to be incapable of producing damaging radiation levels during operation and maintenance and is, therefore, exempt from any control measures or other forms of surveillance. |
| Class IIa/2a | Limits applicable to products whose visible emission does not exceed Class I limits for emission durations of 1,000 seconds or less and are not intended for viewing. | Class 2 lasers are divided into two subclasses, 2 and 2a. A Class 2 laser emits in the visible portion of the spectrum (0.4 to 0.7 μm) and eye protection is normally afforded by the aversion response including the blink reflex. |
| Class II/2 | Limits applicable to products that have emissions in the visible spectrum (400 to 710 nm) for emission durations in excess of 0.25 second, providing that emissions for other durations and/or wavelengths do not exceed the Class I limits. Class II products are considered hazardous for direct long-term ocular exposure. | |
| Class IIIa/3a | Limits to products that have emissions in the visible spectrum and that have beams where the total collectable radiant power does not exceed 5 milliwatts. | Class 3 lasers are divided into two subclasses, 3a and 3b. A Class 3 laser may be hazardous under direct and specular reflection viewing conditions, but the diffuse reflection is usually not a hazard. |
| Class IIIb/3b | Limits applicable to devices that emit in the ultraviolet, visible, and infrared spectra. Class IIIb products include laser systems ranging from 5 to 500 milliwatts in the visible spectrum. Class IIIb emission levels are ocular hazards for direct exposure throughout the range of the Class, and skin hazards at the higher levels of the Class. | |
| Class IV/4 | Exceeding the limits of Class IIIb and are a hazard for scattered reflection as well as for direct exposure. | A Class 4 laser is a hazard to the eye or skin from the direct beam and sometimes from a diffuse reflection and also can be a fire hazard. Class 4 lasers may also produce laser-generated air contaminants and hazardous plasma radiation. |

Label Indications

● EN



Note: Use of controls, adjustments, or procedures other than those specified herein may result in hazardous radiation exposure.

● FDA

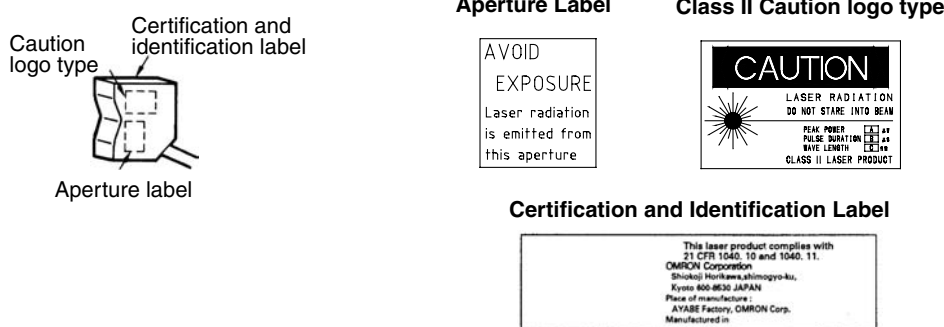

Note: Use of controls, adjustments, or procedures other than those specified herein may result in hazardous radiation exposure.

Dimensions

(Unit: mm)

■ Sensor Heads (Diffuse Reflective)

- ZX-LD40
- ZX-LD100
- ZX-LD300
- ZX-LD40L
- ZX-LD100L
- ZX-LD300L



■ Sensor Heads (Regular Reflective)

- ZX-LD30V
- ZX-LD30VL



■ Sensor Heads (Through-beam)

ZX-LT001
ZX-LT005



**Sensor Head-Amplifier Unit
Connecting Cable (Provided)**



ZX-LT010

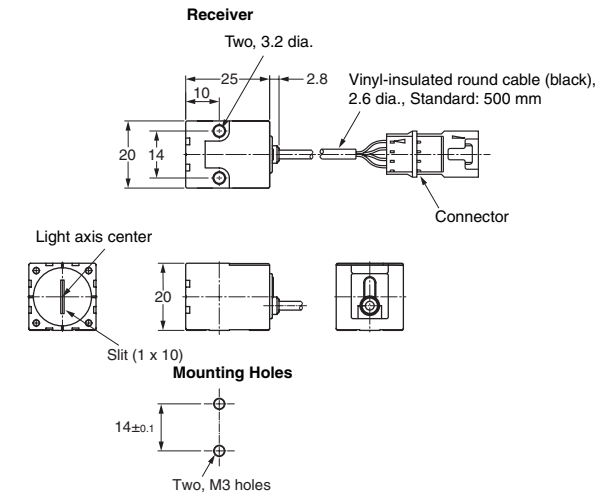

**Sensor Head-Amplifier Unit
Connecting Cable (Provided)**



ZX-LT030



■ Amplifier Units

ZX-LDA11-N
ZX-LDA41-N

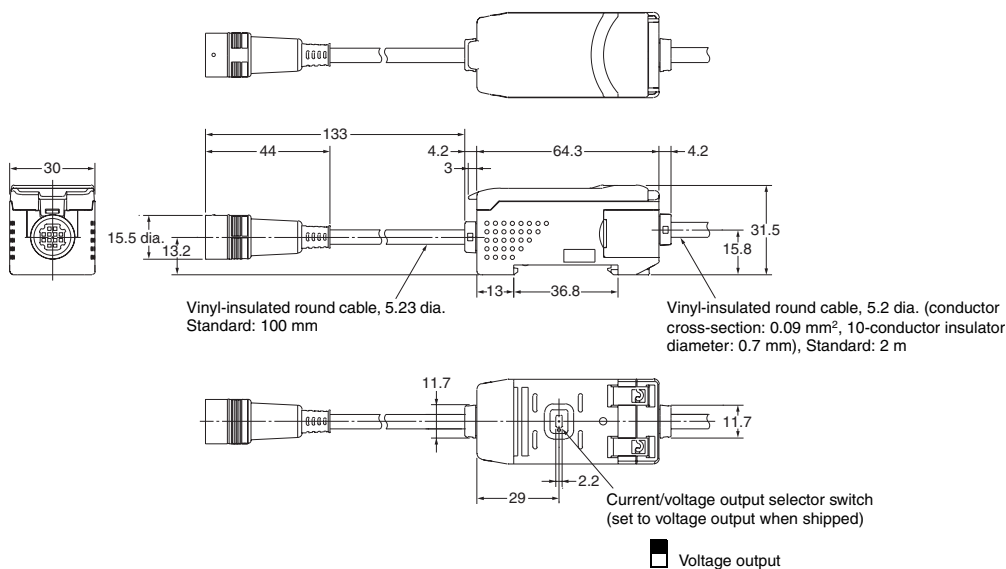

■ Accessories (Order Separately)

Calculating Unit ZX-CAL2

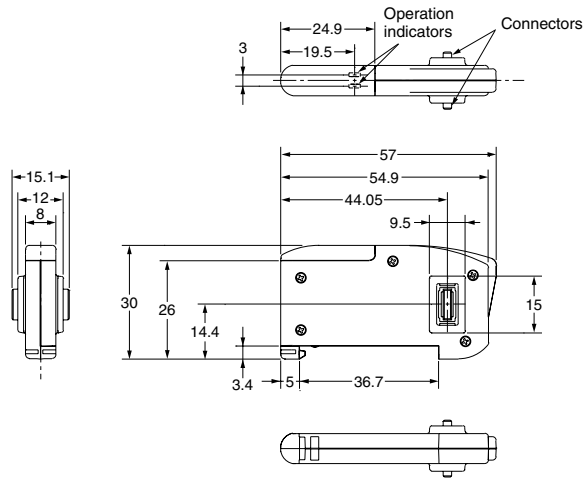

Side-view Attachments ZX-XF12



ZX-XF22



ZX-series Communications Interface Unit
ZX-SF11



Cables with Connectors on Both Ends (for Extension)

- ZX-XC1A (1 m)**
- ZX-XC4A (4 m)**
- ZX-XC8A (8 m)**
- ZX-XC9A (9 m)**



ALL DIMENSIONS SHOWN ARE IN MILLIMETERS.

To convert millimeters into inches, multiply by 0.03937. To convert grams into ounces, multiply by 0.03527.

This document provides information mainly for selecting suitable models. Please read the document Z197 carefully for information that the user must understand and accept before purchase, including information on warranty, limitations of liability, and precautions.

In the interest of product improvement, specifications are subject to change without notice.

OMRON Corporation

Industrial Automation Company

Sensing Devices Division H.Q.

Application Sensors Division

Shiokoji Horikawa, Shimogyo-ku,

Kyoto, 600-8530 Japan

Tel: (81)75-344-7068/Fax: (81)75-344-7107

Read and Understand This Catalog

Please read and understand this catalog before purchasing the products. Please consult your OMRON representative if you have any questions or comments.

Warranty and Limitations of Liability

WARRANTY

OMRON's exclusive warranty is that the products are free from defects in materials and workmanship for a period of one year (or other period if specified) from date of sale by OMRON.

OMRON MAKES NO WARRANTY OR REPRESENTATION, EXPRESS OR IMPLIED, REGARDING NON-INFRINGEMENT, MERCHANTABILITY, OR FITNESS FOR PARTICULAR PURPOSE OF THE PRODUCTS. ANY BUYER OR USER ACKNOWLEDGES THAT THE BUYER OR USER ALONE HAS DETERMINED THAT THE PRODUCTS WILL SUITABLY MEET THE REQUIREMENTS OF THEIR INTENDED USE. OMRON DISCLAIMS ALL OTHER WARRANTIES, EXPRESS OR IMPLIED.

LIMITATIONS OF LIABILITY

OMRON SHALL NOT BE RESPONSIBLE FOR SPECIAL, INDIRECT, OR CONSEQUENTIAL DAMAGES, LOSS OF PROFITS, OR COMMERCIAL LOSS IN ANY WAY CONNECTED WITH THE PRODUCTS, WHETHER SUCH CLAIM IS BASED ON CONTRACT, WARRANTY, NEGLIGENCE, OR STRICT LIABILITY.

In no event shall responsibility of OMRON for any act exceed the individual price of the product on which liability is asserted.

IN NO EVENT SHALL OMRON BE RESPONSIBLE FOR WARRANTY, REPAIR, OR OTHER CLAIMS REGARDING THE PRODUCTS UNLESS OMRON'S ANALYSIS CONFIRMS THAT THE PRODUCTS WERE PROPERLY HANDLED, STORED, INSTALLED, AND MAINTAINED AND NOT SUBJECT TO CONTAMINATION, ABUSE, MISUSE, OR INAPPROPRIATE MODIFICATION OR REPAIR.

Application Considerations

SUITABILITY FOR USE

OMRON shall not be responsible for conformity with any standards, codes, or regulations that apply to the combination of products in the customer's application or use of the product.

At the customer's request, OMRON will provide applicable third party certification documents identifying ratings and limitations of use that apply to the products. This information by itself is not sufficient for a complete determination of the suitability of the products in combination with the end product, machine, system, or other application or use.

The following are some examples of applications for which particular attention must be given. This is not intended to be an exhaustive list of all possible uses of the products, nor is it intended to imply that the uses listed may be suitable for the products:

- Outdoor use, uses involving potential chemical contamination or electrical interference, or conditions or uses not described in this catalog.
- Nuclear energy control systems, combustion systems, railroad systems, aviation systems, medical equipment, amusement machines, vehicles, safety equipment, and installations subject to separate industry or government regulations.
- Systems, machines, and equipment that could present a risk to life or property.

Please know and observe all prohibitions of use applicable to the products.

NEVER USE THE PRODUCTS FOR AN APPLICATION INVOLVING SERIOUS RISK TO LIFE OR PROPERTY WITHOUT ENSURING THAT THE SYSTEM AS A WHOLE HAS BEEN DESIGNED TO ADDRESS THE RISKS, AND THAT THE OMRON PRODUCT IS PROPERLY RATED AND INSTALLED FOR THE INTENDED USE WITHIN THE OVERALL EQUIPMENT OR SYSTEM.

Disclaimers

CHANGE IN SPECIFICATIONS

Product specifications and accessories may be changed at any time based on improvements and other reasons.

It is our practice to change model numbers when published ratings or features are changed, or when significant construction changes are made. However, some specifications of the product may be changed without any notice. When in doubt, special model numbers may be assigned to fix or establish key specifications for your application on your request. Please consult with your OMRON representative at any time to confirm actual specifications of purchased product.

DIMENSIONS AND WEIGHTS

Dimensions and weights are nominal and are not to be used for manufacturing purposes, even when tolerances are shown.

ERRORS AND OMISSIONS

The information in this catalog has been carefully checked and is believed to be accurate; however, no responsibility is assumed for clerical, typographical, or proofreading errors, or omissions.

PERFORMANCE DATA

Performance data given in this catalog is provided as a guide for the user in determining suitability and does not constitute a warranty. It may represent the result of OMRON's test conditions, and the users must correlate it to actual application requirements. Actual performance is subject to the OMRON Warranty and Limitations of Liability.

PROGRAMMABLE PRODUCTS

OMRON shall not be responsible for the user's programming of a programmable product, or any consequence thereof.

COPYRIGHT AND COPY PERMISSION

This catalog shall not be copied for sales or promotions without permission.

This catalog is protected by copyright and is intended solely for use in conjunction with the product. Please notify us before copying or reproducing this catalog in any manner, for any other purpose. If copying or transmitting this catalog to another, please copy or transmit it in its entirety.

Компания «Океан Электроники» предлагает заключение долгосрочных отношений при поставках импортных электронных компонентов на взаимовыгодных условиях!

Наши преимущества:

- Поставка оригинальных импортных электронных компонентов напрямую с производств Америки, Европы и Азии, а так же с крупнейших складов мира;
- Широкая линейка поставок активных и пассивных импортных электронных компонентов (более 30 млн. наименований);
- Поставка сложных, дефицитных, либо снятых с производства позиций;
- Оперативные сроки поставки под заказ (от 5 рабочих дней);
- Экспресс доставка в любую точку России;
- Помощь Конструкторского Отдела и консультации квалифицированных инженеров;
- Техническая поддержка проекта, помощь в подборе аналогов, поставка прототипов;
- Поставка электронных компонентов под контролем ВП;
- Система менеджмента качества сертифицирована по Международному стандарту ISO 9001;
- При необходимости вся продукция военного и аэрокосмического назначения проходит испытания и сертификацию в лаборатории (по согласованию с заказчиком);
- Поставка специализированных компонентов военного и аэрокосмического уровня качества (Xilinx, Altera, Analog Devices, Intersil, Interpoint, Microsemi, Actel, Aeroflex, Peregrine, VPT, Syfer, Eurofarad, Texas Instruments, MS Kennedy, Miteq, Cobham, E2V, MA-COM, Hittite, Mini-Circuits, General Dynamics и др.);

Компания «Океан Электроники» является официальным дистрибьютором и эксклюзивным представителем в России одного из крупнейших производителей разъемов военного и аэрокосмического назначения «JONHON», а так же официальным дистрибьютором и эксклюзивным представителем в России производителя высокотехнологичных и надежных решений для передачи СВЧ сигналов «FORSTAR».



JONHON

«JONHON» (основан в 1970 г.)

Разъемы специального, военного и аэрокосмического назначения:

(Применяются в военной, авиационной, аэрокосмической, морской, железнодорожной, горно- и нефтедобывающей отраслях промышленности)

«FORSTAR» (основан в 1998 г.)

ВЧ соединители, коаксиальные кабели, кабельные сборки и микроволновые компоненты:

(Применяются в телекоммуникациях гражданского и специального назначения, в средствах связи, РЛС, а так же военной, авиационной и аэрокосмической отраслях промышленности).



Телефон: 8 (812) 309-75-97 (многоканальный)

Факс: 8 (812) 320-03-32

Электронная почта: ocean@oceanchips.ru

Web: <http://oceanchips.ru/>

Адрес: 198099, г. Санкт-Петербург, ул. Калинина, д. 2, корп. 4, лит. А